

CELEBRATING 60 YEARS OF HELPING YOU BREAK FROM THE PACK





|  |            |
|--|------------|
| <i>SIMPSON RACING HELMETS</i>          | <i>06</i>  |
| <i>STILO RACING HELMETS</i>            | <i>21</i>  |
| <i>SIMPSON MOTORCYCLE HELMETS</i>      | <i>25</i>  |
| <i>HEAD RESTRAINTS</i>                 | <i>30</i>  |
| <i>OFF-ROAD PRODUCTS</i>               | <i>41</i>  |
| <i>RACING SUITS</i>                    | <i>52</i>  |
| <i>GLOVES</i>                          | <i>78</i>  |
| <i>SHOES</i>                           | <i>83</i>  |
| <i>HARNESSES, NETS AND DRAG CHUTES</i> |            |
| <i>RACING</i>                          | <i>89</i>  |
| <i>AVIATION HARNESSES</i>              | <i>108</i> |
| <i>APPAREL AND GEAR</i>                | <i>109</i> |

*SIMPSON PERFORMANCE PRODUCTS*



*SIXTY YEARS OF VICTORY LAPS*

## ***SIX DECADES OF FIRSTS – FOR US AND YOU.***

Since 1959, Simpson has been leading the way to help you do the same. With the sports first drag chute, fire suit and pure motorsport helmet, Simpson has been a pioneer for innovation and one of the most iconic brands in racing and riding safety.

But as any true competitor knows, you can't rest on those past accomplishments, which is why we're constantly advancing and adding to our product lines. We're as proud of where we've been as where we're going. Thanks for taking us along for the ride – and race. Here's to even more signature celebrations.

Break from the pack with Simpson.

## NEW PRODUCT HIGHLIGHTS



### NEW SIX O RACING SUIT

Page 61

### NEW ST5 KRT

Page 23

### NEW DESERT DEVIL

Page 11

## CERTIFICATIONS/HELMETS



**FIA:** The Fédération Internationale de l'Automobile (FIA), Headquartered in Paris, France, is a nonprofit organization that brings together 227 national motoring and sporting organizations from 132 countries on five continents. FIA Formula One World Championship, FIA World Rally Championship and FIA World Touring Car Championship are among the sanctioning bodies who abide by FIA standards. More information can be found at [fia.com](http://fia.com).



**SFI:** The SFI Foundation, Inc. (SFI) is a nonprofit organization established to issue and administrate safety standards for specialty and performance of automotive and racing equipment. SFI oversees testing and standards for racing suits, restraints and many other high-performance safety products in the United States. NASCAR, SCCA, IRL and NHRA are among the sanctioning bodies who abide by SFI standards. More information can be found at [sffoundation.com](http://sffoundation.com).



**Snell:** Snell Memorial Foundation is known for its ongoing work in setting, maintaining and continually upgrading helmet standards in Motorsports in the world. NASCAR, NHRA, SCCA and IRL are among the sanctioning bodies who abide by Snell helmet standards. More information can be found at [smf.org](http://smf.org).



**DOT:** United States Department of Transportation – meets US DOT requirements for motorcycle helmets.



**ECE 22.05:** Economic Community of Europe (ECE) is the most common helmet standard used internationally. The ECE 22.05 is required by over 50 countries worldwide.

# 90 DAY FINANCING PROGRAM APPLICATION

Simpson Performance Products provides our Racer Net customers a program to purchase an order of \$500.00 or more on a ninety day, no interest financing program, provided the terms and conditions of Simpson's finance program are agreed to and complied with by the customer.

## FINANCING TERMS AND CONDITIONS OF SALE:

- 1 Simpson Performance Products will offer the customer a ninety (90) day, three (3) payment program with no finance charges on any order over \$500.00 to \$2,000.00. Orders over \$2,000.00 will be subject to credit approval.
- 2 The customer agrees to purchase the safety product and make a one-half (½) initial payment to Simpson, plus any applicable shipping charges and taxes. Sixty (60) days after the purchase date of the device, the customer makes a second one-fourth (¼) payment and to complete the transaction, ninety (90) days after the purchase date the customer makes a final one-fourth payment to Simpson.
- 3 The customer must purchase the products with a major credit card (Visa, Master Card, American Express or Discover) and agree to allow Simpson to make two (2) additional charges to the card for equal amounts for the remaining balance of the purchase on the second and third payments days (sixty (60) and ninety (90) days from the date of purchase). This will be an auto-transaction process, and each charge will appear on the customer's monthly statement on the corresponding billing month.
- 4 The customer will be charged a fifty dollar (\$50.00) service fee and a 1.5% monthly interest fee for any credit card charge that is not accepted due to an invalidated credit card status at the time of billing.

**This program is at the complete discretion of Simpson Performance Products, and Simpson reserves the right to limit its implementation and to cancel the program without notice.**

**OFFER DOES NOT APPLY TO CUSTOM SUITS**

Please fax the completed form to **(830) 625-3269** or contact customer service at **(800) 654-7223**

| FINANCING FORM  |  |   |                     |
|---|--|---|---------------------|
| I, _____ on this _____ day of _____, 20____<br>agree to all the Terms and Conditions of Simpson's finance program and authorize Simpson Performance Products to charge the credit card provided in this transaction for the remaining balance of the purchase per the terms and conditions of this agreement. |  |   |                     |
| Total financed purchase \$ _____  |  |   |                     |
| CUSTOMER NAME (PLEASE PRINT):   |  | CUSTOMER SIGNATURE:                       | DATE:<br>/ /        |
| CARD TYPE:<br><input type="checkbox"/> VISA <input type="checkbox"/> MC <input type="checkbox"/> AMEX <input type="checkbox"/> DISCOVER   |  | CREDIT CARD NUMBER:                       |                     |
| NAME AS IT APPEARS ON CREDIT CARD:  |  | EXPIRATION DATE:<br>/ /                   | V-CODE:             |
| BILLING ADDRESS:  |  | CITY:                                     | STATE:<br>ZIP CODE: |
| PHONE NUMBER:   |  | EMAIL ADDRESS:                            |                     |
| PURCHASE CHARGE DATE/AMOUNT:<br>/ / \$ _____  | SECOND CHARGE DATE/AMOUNT:<br>/ / \$ _____ | THIRD CHARGE DATE/AMOUNT:<br>/ / \$ _____ |                     |

GET BEHIND THE WHEEL AND  
**AHEAD**  
OF EVERYTHING ELSE

SIMPSON  
RACING HELMETS

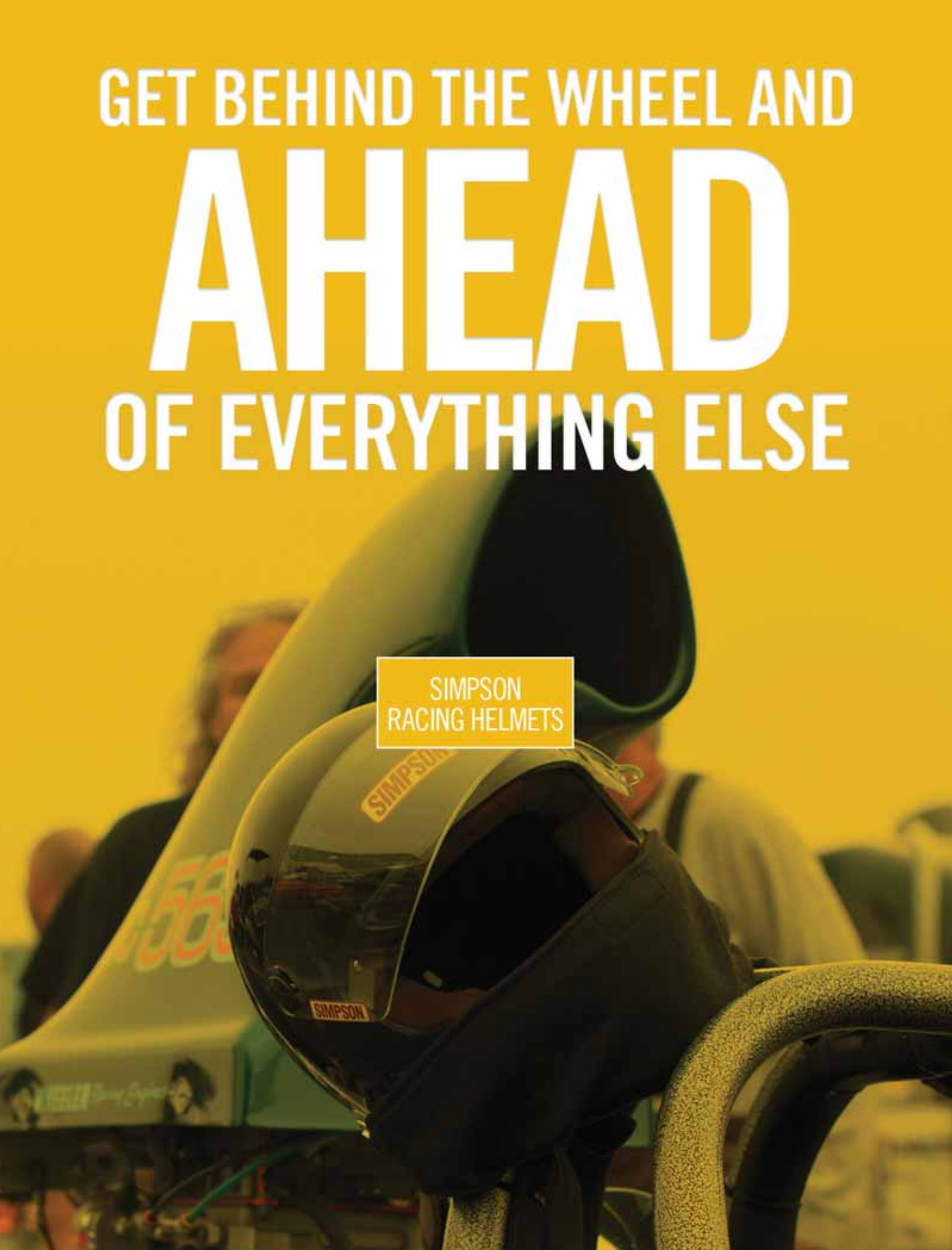

## CARBON EV1

Exceptionally lightweight Auto Clave molded Carbon Fiber construction

### FEATURES

- 1/3 pound lighter than composite Vudo EV1
- Recessed eye port ensures 100% shield seal
- Head Restraint-ready
- Includes padded helmet bag
- Radio communications may be added



CODE: **663C**      SIZE: **7 1/8 - 7 3/4**      PRICE: **\$1,599.95**

### RECOMMENDED FOR

- Circle Track
- Dirt Track
- Drag
- Karting
- Off-Road
- Road Racing

### REPLACEMENT SHIELDS 101 SERIES

| CODE:   | COLOR:  | PRICE:  |
|---------|---------|---------|
| 1010-17 | CLEAR   | \$59.95 |
| 1011-17 | SMOKE   | \$59.95 |
| 1012-17 | AMBER   | \$69.95 |
| 1013-17 | IRIDIUM | \$79.95 |
| 1014-17 | MIRROR  | \$79.95 |

*New 101 Series injection molded shields provide exceptional clarity and no distortion.*

*Carbon helmets are light on the head but heavy on safety.*

TOP SIDE AIR OPTIONS AVAILABLE  
RIGHT CODE: 97032    PRICE: \$150.00  
LEFT CODE: 97033    PRICE: \$150.00



## CARBON AIR INFORCER VUDO

Made from exceptionally lightweight, Auto Clave Molded Carbon Fiber

### FEATURES

- 1/3 lbs. lighter than composite Air Inforcer Vudo
- Design features include a stylish top cap designed for better pipe placement and a low profile for multiple roof/driver height
- Recessed eye port offers a 100% shield seal
- Radio communications may be added
- Includes helmet bag
- Head Restraint-ready



CODE: **662C**      SIZE: **7 1/8 - 7 3/4**      PRICE: **\$1,699.95**

### RECOMMENDED FOR

- Circle Track
- Dirt Track
- Off-Road
- Road Racing

### REPLACEMENT SHIELDS 101 SERIES

| CODE:   | COLOR:  | PRICE:  |
|---------|---------|---------|
| 1010-17 | CLEAR   | \$59.95 |
| 1011-17 | SMOKE   | \$59.95 |
| 1012-17 | AMBER   | \$69.95 |
| 1013-17 | IRIDIUM | \$79.95 |
| 1014-17 | MIRROR  | \$79.95 |

*New 101 Series injection molded shields provide exceptional clarity and no distortion.*

## CARBON DEVIL RAY

The Devil Ray has an exceptionally lightweight carbon shell that weighs in at 2.9 lbs. for size Medium

### FEATURES

- FIA 8859 2015 and Snell SA2015 Certified
- Radio communications may be added
- Top air and side pipe options available, \$150 additional charge (call to order)
- Head Restraint-ready
- Includes padded helmet bag



CODE: **683C**      SIZE: **XS - XXL**      PRICE: **\$879.95**

### RECOMMENDED FOR

- Circle Track
- Dirt Track
- Drag
- Karting
- Off-Road
- Road Racing

### REPLACEMENT SHIELDS 84300 SERIES

| CODE:  | COLOR:  | PRICE:  |
|--------|---------|---------|
| 84300A | CLEAR   | \$49.95 |
| 84301A | SMOKE   | \$49.95 |
| 84304A | AMBER   | \$59.95 |
| 84303  | IRIDIUM | \$69.95 |
| 84306A | MIRROR  | \$69.95 |

FORCED AIR TOP OFFSET  
RIGHT CODE: 97032    PRICE: \$150.00  
LEFT CODE: 97033    PRICE: \$150.00

FORCED AIR TOP  
CODE: 97034  
PRICE: \$150.00

FORCED AIR SIDE  
CODE: 97009  
PRICE: \$150.00

DEVIL RAY PEAK  
CODE: PEAKDR  
PRICE: \$150.00



# SIMPSON RACING HELMETS

## CARBON BANDIT

Classic Bandit flagship design, improved aerodynamics through design innovation.

### FEATURES

FIA 8859-2015 approved. Snell SA 2015 certified.

Radio communications may be added  
Side pipe option available  
Includes helmet bag  
Head Restraint-ready



| CODE:       | TYPE:                | SIZE:         | PRICE:          |
|-------------|----------------------|---------------|-----------------|
| <b>620C</b> | <b>CARBON BANDIT</b> | <b>XS-XXL</b> | <b>\$879.95</b> |

| CODE:       | TYPE:                     | SIZE:         | PRICE:          |
|-------------|---------------------------|---------------|-----------------|
| <b>622C</b> | <b>CARBON DRAG BANDIT</b> | <b>XS-XXL</b> | <b>\$989.95</b> |

### RECOMMENDED FOR REPLACEMENT SHIELDS 89400 SERIES

|              | CODE:  | COLOR:  | PRICE:  |
|--------------|--------|---------|---------|
| Circle Track | 89400A | CLEAR   | \$49.95 |
| Dirt Track   | 89401A | SMOKE   | \$49.95 |
| Off-Road     | 89402A | IRIDIUM | \$69.95 |
| Road Racing  | 89403  | AMBER   | \$59.95 |
|              | 89406A | MIRROR  | \$69.95 |

**FORCED AIR SIDE**  
CODE: 97009  
PRICE: \$150.00

**FORCED AIR TOP (NOT SHOWN)**  
CODE: 97027CLR  
PRICE: \$150.00

## CARBON DIAMONDBACK



The Carbon Diamondback is Snell SA 2015 RATED and manufactured in the USA of exceptionally lightweight, Auto Clave Molded Carbon Fiber.

### FEATURES

Defined Wave Eliminators for reduced buffeting  
Optimally designed shield pivot system  
Recessed eye port offers a 100% shield seal  
Radio communications may be added  
Side pipe air option available  
Helmet bag included  
Head Restraint-ready



| CODE:       | SIZE:                | PRICE:            |
|-------------|----------------------|-------------------|
| <b>629C</b> | <b>7 1/8 - 7 3/4</b> | <b>\$1,599.95</b> |

### RECOMMENDED FOR REPLACEMENT SHIELDS 102 SERIES

|              | CODE:   | COLOR:  | PRICE:  |
|--------------|---------|---------|---------|
| Circle Track | 1020-17 | CLEAR   | \$59.95 |
| Dirt Track   | 1021-17 | SMOKE   | \$59.95 |
| Drag         | 1022-17 | AMBER   | \$69.95 |
| Karting      | 1023-17 | IRIDIUM | \$79.95 |
| Off-Road     | 1024-17 | MIRROR  | \$79.95 |
| Road Racing  |         |         |         |

## VENATOR CARBON FIBER

The Venator features a plush interior with gel ear cups and optional padded ear inserts.

### FEATURES

FIA 8859-2015 approved  
Snell SA 2015 certified  
Plush interior with Simpson branding on cheeks  
Gel ear cups and optional padded ear inserts  
Head Restraint-ready  
Includes padded helmet bag  
Radio communications may be added  
Top air and side pipe options available



| CODE:       | TYPE:                       | SIZE:         | PRICE:          |
|-------------|-----------------------------|---------------|-----------------|
| <b>685C</b> | <b>VENATOR CARBON FIBER</b> | <b>XS-XXL</b> | <b>\$999.95</b> |

### RECOMMENDED FOR REPLACEMENT SHIELDS 84500 SERIES

|              | CODE: | COLOR:  | PRICE:  |
|--------------|-------|---------|---------|
| Circle Track | 84500 | CLEAR   | \$59.95 |
| Dirt Track   | 84501 | SMOKE   | \$59.95 |
| Drag         | 84502 | AMBER   | \$69.95 |
| Karting      | 84503 | IRIDIUM | \$79.95 |
| Off-Road     | 84504 | MIRROR  | \$79.95 |
| Road Racing  |       |         |         |

| CODE:       | TYPE:                       | SIZE:        | PRICE:            |
|-------------|-----------------------------|--------------|-------------------|
| <b>686C</b> | <b>VENATOR PRO FIA 8860</b> | <b>XS-XL</b> | <b>\$1,899.95</b> |

FIA 8860-2015 approved. Snell SA 2015 certified.

**FORCED AIR TOP (NOT SHOWN)** CODE: 97027  
PRICE: \$150.00

**FORCED AIR SIDE (NOT SHOWN)** CODE: 97009  
PRICE: \$150.00

| METRIC SIZE | 54 CM | 56 CM | 57 CM | 59 CM | 60 CM | 62 CM |
|-------------|-------|-------|-------|-------|-------|-------|
| HELMET SIZE | XS    | S     | M     | M/L   | L     | XL    |





## SPEEDWAY SHARK

The Speedway Shark helmet has defined wave eliminators for reduced buffeting.

### FEATURES

Head Restraint-ready  
Includes helmet bag  
Radio communications may be added

### COLORS

White, Gloss Black, +30 Matte Black, Blue, Red, Safety Orange, Silver and Pearl White



|                     |                               |                           |
|---------------------|-------------------------------|---------------------------|
| CODE:<br><b>670</b> | SIZE:<br><b>7 1/8 - 7 3/4</b> | PRICE:<br><b>\$869.95</b> |
|---------------------|-------------------------------|---------------------------|

### RECOMMENDED FOR REPLACEMENT SHIELDS 101 SERIES

|              | CODE:   | COLOR:  | PRICE:  |
|--------------|---------|---------|---------|
| Circle Track | 1010-17 | CLEAR   | \$59.95 |
| Dirt Track   | 1011-17 | SMOKE   | \$59.95 |
| Karting      | 1012-17 | AMBER   | \$69.95 |
| Off-Road     | 1013-17 | IRIDIUM | \$79.95 |
| Road Racing  | 1014-17 | MIRROR  | \$79.95 |

*New 101 Series injection-molded shields provide exceptional clarity and no distortion.*

## AIR INFORCER SHARK

Design features include a stylish top cap designed for better pipe placement and a low profile for multiple roof/driver height.

### FEATURES

Recessed eye port offers a 100% shield seal  
Radio communications may be added  
Includes helmet bag  
Head Restraint-ready

### COLORS

White, Gloss Black, +30 Matte Black, Blue, Red, Safety Orange, Silver and Pearl White



|                     |                               |                           |
|---------------------|-------------------------------|---------------------------|
| CODE:<br><b>677</b> | SIZE:<br><b>7 1/8 - 7 3/4</b> | PRICE:<br><b>\$899.95</b> |
|---------------------|-------------------------------|---------------------------|

### RECOMMENDED FOR REPLACEMENT SHIELDS 101 SERIES

|              | CODE:   | COLOR:  | PRICE:  |
|--------------|---------|---------|---------|
| Circle Track | 1010-17 | CLEAR   | \$59.95 |
| Dirt Track   | 1011-17 | SMOKE   | \$59.95 |
| Off-Road     | 1012-17 | AMBER   | \$69.95 |
| Road Racing  | 1013-17 | IRIDIUM | \$79.95 |
|              | 1014-17 | MIRROR  | \$79.95 |

*New 101 Series injection-molded shields provide exceptional clarity and no distortion.*



### WRAP AROUND AIR

Wrap around constructed from Auto Clave molded carbon fiber.  
CODE: 97058 PRICE: \$150.00



## AIR INFORCER VUDO

Design features include a stylish top cap designed for better pipe placement and a low profile for multiple roof/driver height.

### FEATURES

Recessed eye port with 100% shield seal  
Head Restraint-ready  
Radio communications may be added  
Includes a helmet bag

### COLORS:

White, Gloss Black, +30 Matte Black, Blue, Red, Safety Orange, Silver and Pearl White



|                     |                               |                           |
|---------------------|-------------------------------|---------------------------|
| CODE:<br><b>662</b> | SIZE:<br><b>7 1/8 - 7 3/4</b> | PRICE:<br><b>\$899.95</b> |
|---------------------|-------------------------------|---------------------------|

### RECOMMENDED FOR REPLACEMENT SHIELDS 101 SERIES

|              | CODE:   | COLOR:  | PRICE:  |
|--------------|---------|---------|---------|
| Circle Track | 1010-17 | CLEAR   | \$59.95 |
| Dirt Track   | 1011-17 | SMOKE   | \$59.95 |
| Off-Road     | 1012-17 | AMBER   | \$69.95 |
| Road Racing  | 1013-17 | IRIDIUM | \$79.95 |
|              | 1014-17 | MIRROR  | \$79.95 |

*New 101 Series injection-molded shields provide exceptional clarity and no distortion.*

# SIMPSON RACING HELMETS



## VUDO EV1



The Vudo EV1 features a chin bar that offers excellent coverage.

### FEATURES

Shield pivot system opens and closes with ease.  
A recessed eye port offers 100% shield seal.  
Radio communications may be added  
Includes a helmet bag  
Head Restraint-ready

### COLORS

White, Gloss Black, +30 Matte Black, Blue, Red, Safety Orange, Silver and Pearl White

|                     |                               |                           |
|---------------------|-------------------------------|---------------------------|
| CODE:<br><b>663</b> | SIZE:<br><b>7 1/8 - 7 3/4</b> | PRICE:<br><b>\$869.95</b> |
|---------------------|-------------------------------|---------------------------|

### RECOMMENDED FOR REPLACEMENT SHIELDS 101 SERIES

| RECOMMENDED FOR | CODE:   | COLOR:  | PRICE:  |
|-----------------|---------|---------|---------|
| Dirt Track      | 1010-17 | CLEAR   | \$59.95 |
| Off-Road        | 1011-17 | SMOKE   | \$59.95 |
| Karting         | 1012-17 | AMBER   | \$69.95 |
| Road Racing     | 1013-17 | IRIDIUM | \$79.95 |
| Stock Car       | 1014-17 | MIRROR  | \$79.95 |

*New 101 Series injection-molded shields provide exceptional clarity and no distortion.*

## NEW DR 2



The DR2 or Devil Ray 2 is a modified version of the Devil Ray helmet, homologated to Snell SA2015 certification with loads of new features including a new clear air pipe for top air, or a side air offset.

### FEATURES

Lightweight shell construction  
Features recessed area for ear cups  
Additional air flow  
Removable cheek pads and top pads for a custom fit  
Compatible with the Devil Ray shield and pivot system  
New clear air pipe for top air.  
Side and offset air available.

### COLORS

White, Gloss Black



|                     |                        |                           |
|---------------------|------------------------|---------------------------|
| CODE:<br><b>684</b> | SIZE:<br><b>XS-XXL</b> | PRICE:<br><b>\$599.95</b> |
|---------------------|------------------------|---------------------------|

### RECOMMENDED FOR REPLACEMENT SHIELDS 84300 SERIES

| RECOMMENDED FOR | CODE:  | COLOR:  | PRICE:  |
|-----------------|--------|---------|---------|
| Dirt Track      | 84300A | CLEAR   | \$49.95 |
| Off-Road        | 84301A | SMOKE   | \$49.95 |
| Karting         | 84303  | IRIDIUM | \$69.95 |
| Road Racing     | 84304A | AMBER   | \$59.95 |
| Stock Car       | 84306A | MIRROR  | \$69.95 |

The DR2 model comes ready for electronics and air supply. The air options can be added without drilling holes into the helmet which allows the customer to try different options without the worry of destroying a helmet.

The DR2 model offers improved comfort and fit while maintaining the level of quality found in the Devil Ray. Ventilation was added to the DR2 model in order to let heat escape and keep the driver comfortable. Non-integrated accessories can be purchased and installed by the customer or at the factory.

## DEVIL RAY COMPOSITE



Our popular Devil Ray Carbon helmet is now available in a composite version with the same outstanding customizable features as our Carbon Devil Ray. Composite weighs a little more than carbon, but if you are looking for an incredible value, the composite Devil Ray is for you.

### FEATURES

Snell SA2015 certified  
Required protection at a lower price  
Devil Ray has the most add-on features, including a peak for blocking the sun  
High-quality fit with removable cheek pads  
Helmet includes a smaller set of cheek pads to improve the fit of the helmet if needed  
Head restraint-ready

### COLORS

White, Gloss Black



|                     |                        |                           |
|---------------------|------------------------|---------------------------|
| CODE:<br><b>683</b> | SIZE:<br><b>XS-XXL</b> | PRICE:<br><b>\$399.95</b> |
|---------------------|------------------------|---------------------------|

### RECOMMENDED FOR REPLACEMENT SHIELDS 84300 SERIES

| RECOMMENDED FOR | CODE:  | COLOR:  | PRICE:  |
|-----------------|--------|---------|---------|
| Circle Track    | 84300A | CLEAR   | \$49.95 |
| Dirt Track      | 84301A | SMOKE   | \$49.95 |
| Drag            | 84303  | IRIDIUM | \$69.95 |
| Karting         | 84304A | AMBER   | \$59.95 |
| Off-Road        | 84306A | MIRROR  | \$69.95 |
| Road Racing     |        |         |         |

**FORCED AIR TOP**  
CODE: 97034 PRICE: \$150.00

**FORCED AIR SIDE**  
CODE: 97009 PRICE: \$150.00

**FORCED AIR TOP OFFSET**  
RIGHT CODE: 97032 PRICE: \$150.00  
LEFT CODE: 97033 PRICE: \$150.00

**DEVIL RAY PEAK**  
CODE: PEAKDR PRICE: \$150.00

## NEW DESERT DEVIL

The Desert Devil Off Road Helmet System includes our popular Devil Ray Snell SA 2015 rated helmet, equipped with an offset top air pipe and off road communication kit. Pop the helmet out of the box and you are ready to go riding.

The off-road communications kit comes with a 3.5mm headphone connection that can be plugged into your mobile phone for music using an auxiliary cord easily purchased from your favorite electronics store. The offset top air pipe gives extra head clearance in the vehicle.

### FEATURES

- Lightweight shell construction; Snell SA 2015 Rated
- Includes off-set top air (left side only)
- Includes off-road communication kit with flex boom and water-resistant connections
- Includes integrated speakers
- Removable cheek pads



| CODE:      | TYPE:                     | SIZE:         | PRICE:          |
|------------|---------------------------|---------------|-----------------|
| <b>682</b> | <b>WHITE, GLOSS BLACK</b> | <b>XS-XXL</b> | <b>\$649.95</b> |

| CODE:      | TYPE:               | SIZE:         | PRICE:            |
|------------|---------------------|---------------|-------------------|
| <b>682</b> | <b>CARBON FIBER</b> | <b>XS-XXL</b> | <b>\$1,129.95</b> |

### RECOMMENDED FOR REPLACEMENT SHIELDS 84300 SERIES

|              | CODE:  | COLOR:  | PRICE:  |
|--------------|--------|---------|---------|
| Circle Track | 84300A | CLEAR   | \$49.95 |
| Dirt Track   | 84301A | SMOKE   | \$49.95 |
| Off-Road     | 84303  | IRIDIUM | \$69.95 |
| Road Racing  | 84304A | AMBER   | \$59.95 |
|              | 84306A | MIRROR  | \$69.95 |

### COLORS

White, Gloss Black, and Carbon fiber



## SUPER BANDIT

Classic flagship Bandit design remains true to Simpson's heritage for distinct style and helmets you can trust to do their job.

### FEATURES

- Snell SA 2015 rated
- Head Restraint-ready
- Radio communications may be added

### COLORS

White, Gloss Black, +30 Matte Black, Blue, Red, Safety Orange, Silver and Pearl White



| CODE:      | SIZE:           | PRICE:          |
|------------|-----------------|-----------------|
| <b>621</b> | <b>XS - XXL</b> | <b>\$569.95</b> |

### RECOMMENDED FOR REPLACEMENT SHIELDS 89400 SERIES

|              | CODE:  | COLOR:  | PRICE:  |
|--------------|--------|---------|---------|
| Circle Track | 89400A | CLEAR   | \$49.95 |
| Dirt Track   | 89401A | SMOKE   | \$49.95 |
| Drag         | 89402  | IRIDIUM | \$69.95 |
| Karting      | 89403A | AMBER   | \$59.95 |
| Off-Road     | 89406A | MIRROR  | \$69.95 |
| Road Racing  |        |         |         |

FORCED AIR TOP (NOT SHOWN)  
CODE: 97027CLR  
PRICE: \$150.00

FORCED AIR SIDE  
CODE: 97009  
PRICE: \$150.00



## BANDIT

Classic flagship Bandit design remains true to Simpson's heritage for distinct style and helmets you can trust to do their job.

### FEATURES

- FIA 8859-2015 approved. Snell SA 2015 certified.
- Head Restraint-ready
- Radio communications may be added

### COLORS

White, Gloss Black, +30 Matte Black



| CODE:      | SIZE:           | PRICE:          |
|------------|-----------------|-----------------|
| <b>620</b> | <b>XS - XXL</b> | <b>\$449.95</b> |

### RECOMMENDED FOR REPLACEMENT SHIELDS 89400 SERIES

|              | CODE:  | COLOR:  | PRICE:  |
|--------------|--------|---------|---------|
| Circle Track | 89400A | CLEAR   | \$49.95 |
| Dirt Track   | 89401A | SMOKE   | \$49.95 |
| Drag         | 89402  | IRIDIUM | \$69.95 |
| Karting      | 89403A | AMBER   | \$59.95 |
| Off-Road     | 89406A | MIRROR  | \$69.95 |
| Road Racing  |        |         |         |

## DRAG BANDIT

### FEATURES

Head Restraint-ready  
Drag Sock is SFI.10 rated

### COLORS

White, Gloss Black, +30 Matte Black, Blue, Red, Safety Orange, Silver and Pearl White



| CODE:      | SIZE:         | PRICE:          |
|------------|---------------|-----------------|
| <b>622</b> | <b>XS-XXL</b> | <b>\$779.95</b> |

### RECOMMENDED FOR REPLACEMENT SHIELDS 89400 SERIES

| RECOMMENDED FOR | CODE:  | COLOR:  | PRICE:  |
|-----------------|--------|---------|---------|
| Drag Racing     | 89400A | CLEAR   | \$49.95 |
|                 | 89401A | SMOKE   | \$49.95 |
|                 | 89402  | IRIDIUM | \$69.95 |
|                 | 89403A | AMBER   | \$59.95 |
|                 | 89406A | MIRROR  | \$69.95 |

## DIAMONDBACK

The Diamondback features defined wave eliminators for reduced buffeting.

### FEATURES

Recessed eye port offers a 100% shield seal  
Head Restraint-ready  
Radio communications may be added  
Side pipe air option available

### COLORS:

White, Gloss Black, +30 Matte Black, Blue, Red, Safety Orange, Silver and Pearl White



| CODE:      | SIZE:                | PRICE:          |
|------------|----------------------|-----------------|
| <b>629</b> | <b>7 1/8 - 7 3/4</b> | <b>\$699.95</b> |

### RECOMMENDED FOR REPLACEMENT SHIELDS 102 SERIES

| RECOMMENDED FOR  | CODE:   | COLOR:  | PRICE:  |
|--|---------|---------|---------|
| Circle Track<br>Dirt Track<br>Drag<br>Karting<br>Off-Road<br>Road Racing | 1020-17 | CLEAR   | \$59.95 |
|  | 1021-17 | SMOKE   | \$59.95 |
|  | 1022-17 | AMBER   | \$69.95 |
|  | 1023-17 | IRIDIUM | \$79.95 |
|  | 1024-17 | MIRROR  | \$79.95 |

SIDE PIPE OPTION  
CODE: 97009  
PRICE: \$150.00



## SPEEDWAY RX

Classic "RX" styling with defined Wave Eliminators for reduced buffeting.

### FEATURES

Radio communications may be added  
Head Restraint-ready

### COLORS:

White, Gloss Black, +30 Matte Black, Blue, Red, Safety Orange, Silver and Pearl White



| CODE:      | SIZE:                | PRICE:          |
|------------|----------------------|-----------------|
| <b>651</b> | <b>7 1/8 - 7 3/4</b> | <b>\$699.95</b> |

| CODE:      | TYPE:  | PRICE:          |
|------------|--|-----------------|
| <b>653</b> | <b>DRAG RX WITH BUILT-IN DRAG SOCK (NOT SHOWN)</b> | <b>\$799.95</b> |

### RECOMMENDED FOR REPLACEMENT SHIELDS 102 SERIES

| RECOMMENDED FOR  | CODE:   | COLOR:  | PRICE:  |
|--|---------|---------|---------|
| Dirt Track<br>Drag Racing<br>Karting<br>Off-Road<br>Road Racing<br>Stock Car | 1020-17 | CLEAR   | \$59.95 |
|  | 1021-17 | SMOKE   | \$59.95 |
|  | 1022-17 | AMBER   | \$69.95 |
|  | 1023-17 | IRIDIUM | \$79.95 |
|  | 1024-17 | MIRROR  | \$79.95 |



## VENATOR COMPOSITE



The composite Venator available in colors to complement your race car and racing suit. The Venator features a plush interior with gel ear cups and optional padded ear inserts.

### FEATURES

FIA 8859-2015 approved. Snell SA 2015 certified.  
Plush interior with Simpson branding on cheeks  
Gel ear cups  
Optional padded ear inserts  
Head Restraint-ready  
Radio communications may be added  
Top pipe and side pipe options available

### COLORS

White, Gloss Black, +30 Matte Black

**TOP AIR OPTION**  
CODE: 97027 PRICE: \$150.00

|                     |                          |                           |
|---------------------|--------------------------|---------------------------|
| <b>CODE:</b><br>685 | <b>SIZE:</b><br>XS - XXL | <b>PRICE:</b><br>\$679.95 |
|---------------------|--------------------------|---------------------------|

### RECOMMENDED FOR REPLACEMENT SHIELDS 84500 SERIES

|              | CODE: | COLOR:  | PRICE:  |
|--------------|-------|---------|---------|
| Circle Track | 84500 | CLEAR   | \$59.95 |
| Dirt Track   | 84501 | SMOKE   | \$59.95 |
| Drag         | 84502 | AMBER   | \$69.95 |
| Karting      | 84503 | IRIDIUM | \$79.95 |
| Off-Road     | 84504 | MIRROR  | \$79.95 |

### TOP AIR OPTION

CODE: 97027 PRICE: \$150.00

### SIDE AIR OPTION

CODE: 97009 PRICE: \$150.00

### Venator Chin Guard

| CODE  | FITS     | PRICE    |
|-------|----------|----------|
| 97010 | XS - M/L | \$150.00 |
| 97011 | L - XXL  | \$150.00 |

VENATOR CHIN GUARD



## VOYAGER 2

The Voyager 2 is a redesign for one of our customer favorites, featuring our largest eye port for excellent field of vision. The helmet interior included contrast stitching and branding.

### FEATURES

Snell SA 2015 approved  
Head Restraint-ready  
Radio communications may be added

### COLORS

White, Gloss Black, +30 Matte Black



|                     |                          |                           |
|---------------------|--------------------------|---------------------------|
| <b>CODE:</b><br>610 | <b>SIZE:</b><br>XS - XXL | <b>PRICE:</b><br>\$369.95 |
|---------------------|--------------------------|---------------------------|

### RECOMMENDED FOR REPLACEMENT SHIELDS 88800 SERIES

|              | CODE:  | COLOR:  | PRICE:  |
|--------------|--------|---------|---------|
| Circle Track | 88800A | CLEAR   | \$49.95 |
| Dirt Track   | 88801A | SMOKE   | \$49.95 |
| Drag         | 88802A | AMBER   | \$59.95 |
| Karting      | 88803A | IRIDIUM | \$69.95 |
| Off-Road     | 88804A | MIRROR  | \$69.95 |

Road Racing  
Car Club Enthusiasts



**TOP AIR OPTION**  
CODE: 97027 PRICE: \$150.00



## JUNIOR SPEEDWAY SHARK



The Jr. Speedway Shark is proportionately sized for younger racers.

### FEATURES

SFI 24.1 approved  
Head Restraint-ready  
Radio communications may be added

### COLORS

White, Gloss Black, +30 Matte Black, Blue, Red, Safety Orange, Silver and Pearl White

|                     |                               |                           |
|---------------------|-------------------------------|---------------------------|
| <b>CODE:</b><br>178 | <b>SIZE:</b><br>6 1/2 - 6 5/8 | <b>PRICE:</b><br>\$499.95 |
|---------------------|-------------------------------|---------------------------|

### RECOMMENDED FOR REPLACEMENT SHIELDS J8860 SERIES

|              | CODE:  | COLOR: | PRICE:  |
|--------------|--------|--------|---------|
| Circle Track | J88600 | CLEAR  | \$49.95 |
| Dirt Track   | J88601 | SMOKE  | \$49.95 |
| Drag         | J88603 | AMBER  | \$59.95 |

# SIMPSON RACING HELMETS



## FR CRUISER

Designed for racers who prefer an open face helmet.

### FEATURES

Snell SA 2015 approved  
Head Restraint-ready

### COLORS

White and Gloss black



|                     |                          |                           |
|---------------------|--------------------------|---------------------------|
| CODE:<br><b>632</b> | SIZE:<br><b>XS - XXL</b> | PRICE:<br><b>\$299.95</b> |
|---------------------|--------------------------|---------------------------|

### RECOMMENDED FOR

Circle Track  
Drag  
Off-Road  
Road Racing  
Car Club Enthusiasts

### REPLACEMENT VISOR

CODE:  
99502

PRICE:  
\$15.00



## PIT WARRIOR CREW

The Pit Warrior is worn by professional crews and off-road enthusiasts. Removable and washable interior. Wide field of vision, open face design, lightweight. Fourteen strategically placed vents offer excellent air flow. Factory-installed radio communications available.

### COLORS

Matte Black, White

|                     |                         |                           |
|---------------------|-------------------------|---------------------------|
| CODE:<br><b>145</b> | SIZE:<br><b>S - XXL</b> | PRICE:<br><b>\$149.95</b> |
|---------------------|-------------------------|---------------------------|

### RECOMMENDED FOR

Pit Crew Members

### REPLACEMENT VISOR

CODE:  
145VIS

PRICE:  
\$19.95

## OTW SHORTY

The OTW Shorty is DOT Rated. Includes 4-way adjustable strap system and glare-reducing visor.

### COLORS

Black, White



|                     |                         |                           |
|---------------------|-------------------------|---------------------------|
| CODE:<br><b>143</b> | SIZE:<br><b>XS - XL</b> | PRICE:<br><b>\$129.95</b> |
|---------------------|-------------------------|---------------------------|

### RECOMMENDED FOR

Pit Crew Members



## MEMORABILIA AUTOGRAPH HELMET

A blank signature helmet for your favorite autographs.

### COLORS

White, Black and Matte Black

|  |                           |
|--|---------------------------|
| <b>For display only. Do not wear for racing.</b> | PRICE:<br><b>\$149.00</b> |
|--|---------------------------|

CODE:  
2130001  
2130002  
2130008

COLOR:  
WHITE  
BLACK  
MATTE BLACK

## CUSTOM COLORS

Custom paint colors are available by special order on all Simpson helmets manufactured at our New Braunfels, Texas, facility. Available helmet paint colors include Black and White, at no additional charge, or any of the 6 additional colors shown below, at a small added charge of \$30.00.

Available for **Speedway Shark, Air Inforcer Shark, Air Inforcer Vudo, Vudo EV1, Speedway RX, Diamondback, Super Bandit, Drag Bandit, and Jr. Speedway Shark** models.

**Custom Colors**  
Shown on the **Diamondback**

PRICE:  
**+\$30**



\* Fluorescent paint has limited UV Protection

## MEASURING FOR A HELMET

A correctly fitted helmet should feel like an even amount of pressure is being exerted around your head and cheeks. But helmets break in, so it should fit as tight as you can comfortably wear it. Once fastened, you should NOT be able to pull it off your head in any direction. Attention first-time helmet buyers: If your helmet is loose at all, and doesn't fit well, it CANNOT deliver the best protection. A helmet's strict safety standards can be compromised after only one impact collision. If the integrity is in question, send it back to us for proper inspection.

### MEASURE DIRECTLY ABOVE THE BROW LINE FOR THE BEST HELMET FIT.

Simpson Recommends Inspection Of Your Helmet After Any Impact Collision.

#### ADULT HELMET SIZE CHART

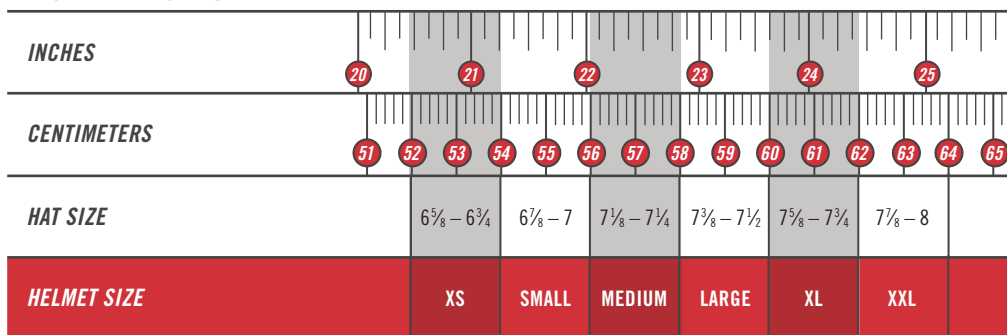

#### YOUTH HELMET SIZE CHART





## NEW MULTI-EQUIPMENT DRYER FOR HELMET, GLOVES AND FOOTWEAR

Simpson's newest antibacterial multi-equipment dryer circulates air in a temperature-controlled environment to safely dry helmets, gloves and footwear.

It's hard to put that wet smelly helmet on your head. What's happening to your expensive equipment? The truth is cheek pads and liners degrade over time from perspiration and bacteria. Keep your equipment in peak condition longer by stopping mold and mildew before it starts. You can focus on your driving or riding and quickly refresh between events.

CODE: **97100**  
PRICE: **\$129.95**

**FEATURES**  
Anti-bacterial, eliminates odors and controls bacteria growth  
Dual dryer ports  
110 volt



## RACING OPTICS AND STILO TEAROFFS

2mm laminated tearoffs. 3 Speedstacks™ of 10 tearoffs.



CODE: 98022      FITS: GOLD ALUMINUM TEAROFF POSTS. FITS: ALL MODELS      PRICE: \$14.95



**stilo**

*Any competition one helmet*

### Laminated tearoffs

| CODE   | FITS   | PRICE   |
|--------|--|---------|
| 10201C | VOYAGER HELMET MODEL 410   | \$33.95 |
| 10203C | JR. SPEEDWAY SHARK   | \$33.95 |
| 10204C | RX, SUPER BANDIT, BANDIT, X BANDIT, DIAMONDBACK  | \$33.95 |
| 10209C | SUPER SHARK, VUDO, AIR INFORCER SHARK, DEVIL RAY, VOYAGER EVOLUTION, SIDEWINDER VOYAGER, VOYAGER 2, SNELL SA 2015 MODELS | \$33.95 |
| 10210C | VENATOR  | \$33.95 |

### Stilo tearoffs

| CODE   | FITS                  | PRICE   |
|--------|-----------------------|---------|
| 10259C | STILO ST5 SMALL TAB   | \$33.95 |
| 10252C | STILO ST5 LARGE TAB   | \$33.95 |
| 10253C | STILO ST5 DIRT MARKET | \$33.95 |

## NEW ACRYSOL SHIELD CLEANER

Acrysol shield cleaner is recommended by Stilo for helmet shield care. Acrysol is also compatible with Simpson helmet shields. Visit [simpsonperformance.com](http://simpsonperformance.com) for complete instructions and recommendations.



CODE: **YA0640**  
PRICE: **\$19.95**

## DUAL SHIELD BAG



CODE: **23900**  
PRICE: **\$5.99**



## REPLACEMENT SHIELDS

### 101 SERIES - FITS SHARK AND VUDO MODELS

| CODE:   | COLOR:  | PRICE:  |
|---------|---------|---------|
| 1010-17 | CLEAR   | \$59.95 |
| 1011-17 | SMOKE   | \$59.95 |
| 1012-17 | AMBER   | \$69.95 |
| 1013-17 | IRIDIUM | \$79.95 |
| 1014-17 | MIRROR  | \$79.95 |

New 101 Series injection molded shields provide exceptional clarity and no distortion.

### 102 SERIES - FITS X BANDIT, DIAMONDBACK, SKULL AND RX MODELS

| CODE:   | COLOR:  | PRICE:  |
|---------|---------|---------|
| 1020-17 | CLEAR   | \$59.95 |
| 1021-17 | SMOKE   | \$59.95 |
| 1022-17 | AMBER   | \$69.95 |
| 1023-17 | IRIDIUM | \$79.95 |
| 1024-17 | MIRROR  | \$79.95 |

### 103 SERIES - FITS SA10 SW VOYAGER, VOYAGER EVOLUTION AND BULL DOG

| CODE:   | COLOR:  | PRICE:  |
|---------|---------|---------|
| 1030-12 | CLEAR   | \$59.95 |
| 1031-12 | SMOKE   | \$59.95 |
| 1032-12 | AMBER   | \$69.95 |
| 1033-12 | IRIDIUM | \$79.95 |
| 1034-12 | MIRROR  | \$79.95 |

### ADDITIONAL

| SNELL 2010 AND 2015 HELMET SHIELDS                                 | CODE:         | FITS:  | PRICE:  |
|--|---------------|--|---------|
| Clear and Smoke prices listed. Amber is \$59.95, Iridium, \$69.95. | 84300 SERIES  | DEVIL RAY  | \$49.95 |
|  | 89400 SERIES  | BANDIT, SUPER BANDIT, CARBON BANDIT, DRAG BANDIT, CH3N02 | \$49.95 |
|  | 89100 SERIES  | OUTLAW BANDIT  | \$49.95 |
|  | 88200A SERIES | VOYAGER, MODEL 410                                       | \$49.95 |
|  | 89900 SERIES  | K10, KART HELMET   | \$49.95 |
|  | 86030 SERIES  | STREET BANDIT  | \$49.95 |
|  | 84500 SERIES  | VENATOR  | \$59.95 |
|  | 88800 SERIES  | VOYAGER 2  | \$49.95 |

## PIVOT KITS

### DETENT PIVOT KITS

| Hardware included. | CODE: | FITS:                                      | PRICE:  |
|--------------------|-------|--|---------|
|                    | 99014 | 101, 102, 103 SERIES AND VOYAGER 2 SHIELDS | \$12.95 |
|                    | 99013 | DEVIL RAY                                  | \$12.95 |
|                    | 99016 | BANDIT/CARBON BANDIT                       | \$12.95 |
|                    | 99022 | VOYAGER MODEL 410                          | \$12.95 |
|                    | 99002 | SUPER BANDIT                               | \$12.95 |
|                    | 99018 | VENATOR                                    | \$12.95 |



## RADIO COMMUNICATION



Simpson is proud to offer Rugged Radio's exclusive communication technology for Racing Radio Driver and Crew Communication systems. Order your favorite Simpson helmet complete with factory-installed communications equipment. Save time, save on shipping charges. Helmet kit pricing as shown includes installation. Simpson helmets are fully certified to be Snell and/or FIA compliant when equipped with Rugged Radios helmet kit installations. PCI Radios also available for off-road applications. Call us at 800-654-7223.

### OFF-ROAD HELMET KIT

Kit Includes Flex Boom, Helmet Speakers and 3.5 mm Ear Bud Jack



This complete off-road flex boom helmet kit features Rugged Radios' new Dura-Link Sealed Connector, Clear Hear speakers and dynamic noise canceling mic for best audio performance, and 3.5mm input port for music cable or ear buds. The Dura-Link Seal, featured on all Rugged helmet kits, seals the connection between the intercom cable and helmet kit plug. The Dura-Link Seal protects the connection contacts from water, mud and dirt which can affect audio performance and works with current Rugged off-road intercom cables.

| CODE  | TYPE                | PRICE    |
|-------|---------------------|----------|
| 96044 | OFF-ROAD HELMET KIT | \$129.95 |

### EAR CUPS

For an additional \$100, ear cup speakers can be added to any radio helmet kit.



| CODE  | TYPE  | PRICE    |
|-------|---|----------|
| 96002 | EAR CUPS W/SPEAKERS & INSTALLED (ONE WAY RADIO) | \$159.95 |
| 96001 | EAR CUPS INSTALLED, W/O SPEAKERS                | \$69.95  |
| 96000 | EAR CUPS, W/O INSTALLATION AND SPEAKERS         | \$39.95  |

### NASCAR HELMET KIT

The National Association for Stock Car Auto Racing



| CODE  | TYPE  | PRICE    |
|-------|---|----------|
| 96023 | NASCAR HELMET KIT (3 COND) W/FLEX BOOM & COIL | \$159.95 |
| 96033 | WITH EAR CUP SPEAKERS                         | \$269.95 |

### NASCAR HELMET KIT

The National Association for Stock Car Auto Racing



| CODE  | TYPE   | PRICE    |
|-------|--|----------|
| 96003 | NASCAR HELMET KIT (3 COND) W/FLEX BOOM & STRAIGHT CORD | \$159.95 |
| 96013 | WITH EAR CUP SPEAKERS                                  | \$269.95 |

### IMSA HELMET KIT

The International Motor Sports Association



| CODE  | TYPE   | PRICE    |
|-------|--|----------|
| 96024 | IMSA HELMET KIT (4 COND) W/FLEX BOOM & COIL CORD | \$159.95 |
| 96034 | WITH EAR CUP SPEAKERS                            | \$269.95 |

### IMSA HELMET KIT

The International Motor Sports Association



| CODE  | TYPE   | PRICE    |
|-------|--|----------|
| 96004 | IMSA HELMET KIT (4 COND) W/FLEX BOOM & STRAIGHT CORD | \$159.95 |
| 96014 | WITH EAR CUP SPEAKERS                                | \$269.95 |

## HELMET EJECT AND EMS



Simpson's Eject Helmet Removal System is a small air bladder that fits easily into any helmet, without changing its fit or feel. In the event of a crash, First Responders can help reduce the risk of secondary neck or spine injuries by inflating the Eject System which gently lifts the helmet off the head.

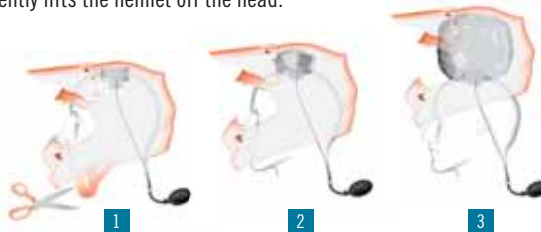

### EJECT EMT AMBULANCE/TRACK KIT

Complete Eject Kit for track or ambulance contains:

- 3 EMT Helmet Bladders
- 1 Bulb Inflator
- 1 CO2 Inflator
- 4 CO2 Cartridges (16 grams each)
- 1 Track Bag



CODE **898-01-KIT** PRICE **\$299.99**

### EJECT CO2 CARTRIDGE

Carbon Dioxide cartridge for Eject CO2 Inflator



CODE **896-01-30-B** PRICE **\$9.99**

### EJECT EMT BLADDER

Air bladder with attached hose for helmet installation.



CODE **892-01-BLR** PRICE **\$69.99**

### EJECT BULB INFLATOR

Eject Inflator powered by a small rubber bulb



CODE **897-01-30** PRICE **\$39.99**

### EJECT CO2 INFLATOR

Eject Inflator powered by a small Carbon Dioxide cartridge. Includes one cartridge. Additional cartridges sold separately.



CODE **895-01-30** PRICE **\$24.99**

### EJECT BLADDER

Eject and installation.



|                   |                                 |                |
|-------------------|---------------------------------|----------------|
| CODE              | TYPE                            | PRICE          |
| <b>890-01-30</b>  | <b>EJECT BLADDER</b>            | <b>\$49.99</b> |
| <b>890-01-30I</b> | <b>EJECT BLADDER W/ INSTALL</b> | <b>\$69.99</b> |

# SIMPSON RACING HELMETS

## BUILT IN HELMET SKIRTS



### Helmet Skirts

| CODE  | FITS                                       | PRICE    |
|-------|--|----------|
| 97008 | SFI 3.3/5 CarbonX®                         | \$79.00  |
| 97028 | SFI 3.3/10 CarbonX®                        | \$100.00 |
| 97038 | SFI 3.3/5 CarbonX® CONTOURED HELMET SKIRT  | \$79.00  |
| 97048 | SFI 3.3/10 CarbonX® CONTOURED HELMET SKIRT | \$100.00 |



F/C AIR SYSTEM

DRAG SOCK

## THE F/C AIR SYSTEMS



Can be installed on most Simpson fullface helmets. Advanced internal airflow system distributes fresh air throughout, with venting to the mouth/nose, and 2 clearing ports on each side to eliminate fogging. Drag sock and Kevlar® gasket purchased separately. Requires use of drag sock.

### Drag Air System

| CODE:        | PRICE:          |
|--------------|-----------------|
| <b>97025</b> | <b>\$129.00</b> |

### Drag Sock

SFI 3.3/10 CarbonX®, built in drag sock

| CODE:        | PRICE:          |
|--------------|-----------------|
| <b>97003</b> | <b>\$159.00</b> |

## THE F/C EXTERNAL AIR SYSTEM

The F/C Air System was designed in 1998 to provide constant flow or on-demand air to the driver in the event of a fire. Composite bottle will hold 5 to 10 minutes of air, depending on flow setting. System includes Flow Control Regulator, ball valve, 8 ft. fire rated hose, hose fittings and 3000 PSI rated bottle (114 cubic inches) and shut-off valve assembly.



### Air System

| CODE:      | PRICE:          |
|------------|-----------------|
| <b>FCC</b> | <b>\$699.00</b> |



## BREATH DEFLECTOR

Helps seal mouth and nose area and keeps fresh air in and unwanted fumes out. Can be molded to conform to contours of nose. Prevents fogging and can be used in conjunction with Sidewinder F.A.S. Must have helmet to install at factory.

Adjustable Breath Deflector (Shown)  
Breath Deflector

| CODE:        | PRICE:         |
|--------------|----------------|
| <b>97035</b> | <b>\$99.00</b> |
| <b>97022</b> | <b>\$99.00</b> |

## CHIN FLAP (NOT SHOWN)



Helps seal area under chin to prevent air flow that can cause lift. Prevents dust and debris from entering helmet. Reduces noise while improving microphone pickup. Must have helmet to install at factory.

### Chin Flap

| CODE:        | PRICE:         |
|--------------|----------------|
| <b>97015</b> | <b>\$69.00</b> |

# TRAVEL AT THE SPEED OF LIGHTER

STILO RACING  
HELMETS



# STILO RACING HELMETS

## STILO RACING HELMETS

Stilo helmets are some of the lightest in the world. They're worn by winning drivers worldwide including F1 Mercedes driver Valtteri Bottas, Monster Energy NASCAR Cup Series champions Jimmie Johnson and Kyle Busch, IndyCar Series champion Tony Kanaan and rising star Pato O'Ward and WRC champion Sébastien Loeb. Stilo is the first helmet manufacturer to achieve the FIA's prestigious 8860-2018 standard. Demand the best, be the best. Visit our website at [StiloHelmets.com](http://StiloHelmets.com) or call 833-44-STILO (78456).



**ST5 FN**  
**ZERO 8860**



**ST5 GT**  
**CARBON**

**Stilo**

*Any competition one helmet*



**ST5 GT COMPOSITE**



ESAPEKKA LAPPI, WRC DRIVER

## STILO KART HELMETS

Turn heads with a style that closely resembles the top range Stilo ST5 Zero helmet. Visit [stilohelmets.com](http://stilohelmets.com) for more details and to view the custom kart options for a unique look on the track. A safer helmet means faster laps.

YOUTH  
RATED

**ST5 CMR**

Colors: Matte Black (shown) and White



SNELL  
K 2015 RATED

**ST5 KRT**

Shown with back spoiler and front spoiler  
Color: White



PATO O'WARD, INDYCAR DRIVER

### STILO HELMET SIZE CHART

| SIZE       | CENTIMETERS | INCHES    | US HAT SIZE | US HAT SIZE |
|------------|-------------|-----------|-------------|-------------|
| XS         | 53 - 54 CM  | 21 - 21¼  | 6⅝ - 6¾     | SMALL SHELL |
| SMALL      | 55 - 56 CM  | 21⅝ - 22  | 6⅞ - 7      | SMALL SHELL |
| MEDIUM     | 57 - 58 CM  | 22¼ - 22¾ | 7⅛ - 7¼     | SMALL SHELL |
| LARGE      | 59 - 60 CM  | 23¼ - 23⅝ | 7¼ - 7½     | SMALL SHELL |
| LARGE PLUS | 60 - 61 CM  | 23¾ - 23⅞ | 7¼ - 7½     | LARGE SHELL |
| XL         | 61 - 62 CM  | 24 - 24⅜  | 7⅝ - 7¾     | LARGE SHELL |
| XXL        | 63 - 64 CM  | 24¼ - 25⅝ | 7⅞ - 8      | LARGE SHELL |
| XXXL       | 64 - 65 CM  | 25⅝ - 25½ | 8 - 8⅝      | LARGE SHELL |

## STILO RALLY HELMETS



### TROPHY JET

ST5 Style with sunshield option, great value, included microphone holder



### TROPHY DES PLUS

Snell 2015 certified open face design for Rally and Autocross, with electronics



### WRC DES ZERO 8860

Setting the bar for rally drivers and navigators. Fully customizable.



### WRC DES CARBON PIUMA

An integrated microphone boom sets the WRC DES apart from other open face helmets



DON'T JUST RIDE LIKE YOU  
**STOLE IT**  
LOOK LIKE YOU STOLE IT

SIMPSON  
MOTORCYCLE HELMETS



# SIMPSON MOTORCYCLE HELMETS

## NEW MOD BANDIT



### Modular function and convenience meets Simpson style and attitude.

One hand modular function, communication system ready, Pinlock system compatible, and internal sun shield are highlights of the new Mod Bandit. Ready to ride across town or around the world, the Mod Bandit offers the function and style you are looking for.

#### FEATURES:

- DOT/ECE certification
- Tri composite or carbon fiber shell combined with a polycarbonate alloy chin bar
- One hand chin bar opening
- Ability to lock the chin bar in the open position
- Metal chin bar locking components for strength and durability
- Communication system compatibility
- Multiple adjustable intake vents
- Free flow, low pressure exhaust vents aids in air extraction
- Integrated spoiler maximizes stability and aids in air extraction
- Removable, washable, hypoallergenic and antimicrobial cheek pads and interior
- Pinlock shield insert ready
- Toolless, quick release, shield changing
- Smoke tinted internal sun shield, other options available
- Rear facing cheek pad reflective panels
- Removable, noise reducing chin curtain
- Traditional, double D-ring retention system

#### COLORS

White, Black, Flat Black, Carbon + \$200

#### Composite

| CODE: | SIZE:    | COMPOSITE PRICE: |
|-------|----------|------------------|
| M59   | XS - XXL | \$479.95         |

#### Carbon Fiber

| CODE: | SIZE     | CARBON FIBER PRICE: |
|-------|----------|---------------------|
| M59   | XS - XXL | \$679.95            |

#### REPLACEMENT SHIELDS MB SERIES

##### EXTERIOR SHIELDS

| CODE: | COLOR:      | PRICE:  |
|-------|-------------|---------|
| MBCSE | CLEAR       | \$49.95 |
| MBSSE | SMOKE       | \$49.95 |
| MBASE | AMBER       | \$49.95 |
| MBISE | IRIDIUM     | \$69.95 |
| MBMSE | MIRROR      | \$69.95 |
| MBGSE | GOLD MIRROR | \$69.95 |

##### INTERIOR SHIELDS

| CODE:  | COLOR:      | PRICE:  |
|--------|-------------|---------|
| GBCSI  | CLEAR       | \$39.95 |
| GBLSSI | LIGHT SMOKE | \$39.95 |
| GBDSSI | SMOKE       | \$39.95 |
| GBASI  | AMBER       | \$39.95 |

Watch  
[SimpsonMotorcycleHelmets.com](http://SimpsonMotorcycleHelmets.com)  
 for limited edition helmets



MOD Bandit shown in various positions

## GHOST BANDIT



ECE 22.05  
Approved

Designed 100% with motorcycle riders in mind, the Simpson Ghost Bandit is prepared to handle just about any type of riding in killer style and complete comfort. The lightweight shell has been aerodynamically tuned for motorcycle riding, and is fully ventilated for maximum airflow when, and where, you need it most. Integrated speakers and microphone pockets make it easy to install your favorite communication device, and a drop-down sun visor makes riding through changing light conditions a breeze.

### FEATURES

- Lightweight Composite and Carbon Fiber versions
- DOT/ECE Certified
- Removable liner
- Internal sun visor
- Multiple shield options
- Integrated speaker and boom mic pockets
- Dual adjustable chin vents
- Top and rear ventilation
- Removable chin air dam

### COLORS

White, Black, Flat Black, Carbon + \$200



CARBON  
WITH SMOKE SHIELD



GHOST BANDIT REVOLT  
WITH SMOKE SHIELD

Look for limited edition models at  
[SimpsonMotorcycleHelmets.com](http://SimpsonMotorcycleHelmets.com)

ADDITIONAL COLORS  
GLOSS BLACK  
WITH IRIDIUM SHIELD



WHITE  
WITH MIRROR SHIELD



FLAT BLACK  
WITH SMOKE SHIELD



### Tri Composite

| CODE: | SIZE:    | TRI COMPOSITE PRICE: |
|-------|----------|----------------------|
| GBD   | XS - XXL | \$449.95             |

### Carbon Fiber

| CODE: | SIZE:    | CARBON FIBER PRICE: |
|-------|----------|---------------------|
| GBD   | XS - XXL | \$649.95            |

### REPLACEMENT SHIELDS GB SERIES

#### EXTERIOR SHIELDS

| CODE: | COLOR:      | PRICE:  |
|-------|-------------|---------|
| GBCSE | CLEAR       | \$49.95 |
| GBLSE | LIGHT SMOKE | \$49.95 |
| GBDSE | SMOKE       | \$49.95 |
| GBASE | AMBER       | \$49.95 |
| GBISE | IRIDIUM     | \$69.95 |
| GBMSE | MIRROR      | \$69.95 |
| GBGSE | GOLD MIRROR | \$69.95 |

#### INTERIOR SHIELDS

| CODE:  | COLOR:      | PRICE:  |
|--------|-------------|---------|
| GBCSI  | CLEAR       | \$39.95 |
| GBLSSi | LIGHT SMOKE | \$39.95 |
| GBDSSi | SMOKE       | \$39.95 |
| GBASI  | AMBER       | \$39.95 |

Motorcycle Helmets shown with optional shields.  
All helmets shipped with clear shield.



UNKNOWN HARLEY STUNT TEAM

# SIMPSON MOTORCYCLE HELMETS

## OUTLAW BANDIT

### FEATURES

Chin air ram duct for improved air circulation, reduced lift counter measures DOT and Snell M2015

### COLORS

White, Gloss Black, Flat Black, Gunmetal and Candee



**NEW CANDEE**  
WITH SMOKE SHIELD

Motorcycle Helmets shown with optional shields.  
All helmets shipped with clear shield.



Fiberglass

CODE: **28315**      SIZE: **XS - XXL**      PRICE: **\$399.95**

### REPLACEMENT SHIELDS 89200 SERIES

Helmet size specific

| CODE:  | COLOR:      | PRICE:  |
|--------|-------------|---------|
| 89200M | CLEAR       | \$49.95 |
| 89201M | SMOKE       | \$49.95 |
| 89202M | AMBER       | \$49.95 |
| 89203M | IRIDIUM     | \$69.95 |
| 89204M | MIRROR      | \$69.95 |
| 89206M | GOLD MIRROR | \$69.95 |

Replacement Pivot Kits

CODE: **99011**      PRICE: **\$12.95**



ADDITIONAL COLORS  
GUNMETAL WITH GOLD SHIELD

WHITE

FLAT BLACK

GLOSS BLACK



FLAT BLACK

## STREET BANDIT

The Street Bandit Motorcycle Helmet is one of our best-selling helmets.

### FEATURES

DOT and Snell M2015  
Classic Bandit look for the motorcycle rider  
The Street Bandit features an enlarged eye port area for excellent field of vision  
Chin air ram duct vents  
Top vents with shutoff option

### COLORS

White, Gloss Black and Flat Black

Fiberglass

CODE: **MSB15**      SIZE: **XS - XXL**      PRICE: **\$299.95**

### REPLACEMENT SHIELDS 86030 SERIES

| CODE:  | COLOR:     | PRICE:  |
|--------|------------|---------|
| 86030M | CLEAR      | \$49.95 |
| 86031M | DARK SMOKE | \$49.95 |
| 86032M | AMBER      | \$49.95 |
| 86033M | IRIDIUM    | \$69.95 |
| 86034M | MIRROR     | \$69.95 |

Replacement Pivot Kits

CODE: **99017**      PRICE: **\$12.95**

Motorcycle Helmets shown with optional shields.  
All helmets shipped with clear shield.

ADDITIONAL COLORS  
WHITE  
HELMET SHOWN WITH IRIDIUM SHIELD

GLOSS BLACK  
HELMET SHOWN WITH SMOKE SHIELD



## HERITAGE COLLECTION

Heritage Collection helmets are re-creations of 1970s model Simpson helmets that have vintage fit, function and style, but meet modern DOT safety requirements.

### M30

Classic Simpson M30 styling.

#### FEATURES

Cool Max<sup>®</sup> lined fabric moves moisture away from your body, keeping you cool and comfortable

DOT Rated

“Free Stop” pivot system allows the wearer to stop the shield at any angle

Additional cheek pads available

Approximate weight of Carbon

versions – 2.5 pounds

Approximate weight of non-Carbon

versions – 3.0 pounds

#### COLORS

White, Gloss Black, Flat Black and Gloss Carbon, Satin Carbon



SHOWN WITH OPTIONAL IRIDIUM SHIELD



Fiberglass

|                      |                         |                                      |
|----------------------|-------------------------|--------------------------------------|
| CODE:<br><b>M30D</b> | SIZE:<br><b>XS - XL</b> | FIBERGLASS PRICE:<br><b>\$349.95</b> |
|----------------------|-------------------------|--------------------------------------|

Carbon Fiber

|                      |                         |  |
|----------------------|-------------------------|--|
| CODE:<br><b>M30D</b> | SIZE:<br><b>XS - XL</b> | CARBON FIBER PRICE:<br><b>\$549.95</b> |
|----------------------|-------------------------|--|

#### REPLACEMENT SHIELDS M30 SERIES

| CODE:  | COLOR:        | PRICE:  |
|--------|---------------|---------|
| M30CS  | CLEAR         | \$49.95 |
| M30LSS | LIGHT SMOKE   | \$49.95 |
| M30DSS | DARK SMOKE    | \$49.95 |
| M30LRS | LIGHT IRIDIUM | \$69.95 |
| M30LCS | LIGHT CHROME  | \$69.95 |

Replacement Pivot Kits

|                       |                          |
|-----------------------|--------------------------|
| CODE:<br><b>M30PK</b> | PRICE:<br><b>\$14.95</b> |
|-----------------------|--------------------------|

### M50

The M50 Moto from the 70s is reborn in a sleek helmet with a nod to vintage, backed by over 50 years of Simpson technology. DOT Rated. The M50 includes a five-snap visor. See photo.

Additional cheek pads available

#### COLORS

White, Gloss Black and Flat Black, Flat Gunmetal, Red and Yellow



GLOSS BLACK

Fiberglass

|                      |                         |                           |
|----------------------|-------------------------|---------------------------|
| CODE:<br><b>M50D</b> | SIZE:<br><b>XS - XL</b> | PRICE:<br><b>\$249.95</b> |
|----------------------|-------------------------|---------------------------|

#### ADDITIONAL VISOR

|                          |                         |
|--------------------------|-------------------------|
| CODE:<br><b>M50VISOR</b> | PRICE:<br><b>\$9.95</b> |
|--------------------------|-------------------------|



VARIOUS GOGGLE COLORS AND MODELS AVAILABLE



ADDITIONAL COLORS  
WHITE



RED



YELLOW



FLAT GUNMETAL



# STRAP IN TO WIN



HEAD RESTRAINTS



## HEAD RESTRAINTS

### WHAT YOU NEED TO KNOW

#### Why do I need a frontal head restraint system?

Quite simply, head restraints save racers' lives!

If you are unfortunate enough to be involved in an accident during a race, your seatbelt is likely going to do its job and stop your body from moving forward. The head restraint will do its job and stop your head from whipping forward and placing enormous strain on your neck. A racer's head is made heavier than normal by the added weight of a helmet. Frontal impact in a race car can cause basilar skull fractures which are often fatal and have taken the lives of some of history's greatest racers. Keep in mind that it isn't necessarily how fast you are going but how fast you stop that causes some of the worst injuries.

#### What is the difference between the different head restraint devices?

Simpson offers a complete line of HANS Devices and Simpson Hybrids. The HANS is a yoke style head restraint and has a loyal following worldwide. The Hybrid is a backpack style device designed to stay with the racer upon entering or exiting the racecar. The Hybrid line features the Hybrid S, the only head restraint in the world that is tested and proven to work with 3-point OEM seatbelts, a plus for HPDE and Track Day participants. The HANS and Hybrids are popular with top level NASCAR, NHRA and WRC drivers. The difference in head restraint models comes down to weight – all HANS and Hybrid head restraints offer the same exceptional level of protection. We offer composite and carbon fiber models to service every price level. Simpson has historically worked to lower the price on head restraints to make this crucial piece of safety equipment affordable to all racers.

#### Do I need to use a specific seatbelt harness?

No, but the configuration of the seatbelt harness is critical and some head restraints are tailored for use with a FHR-specific seatbelt harness.

The shoulder strap mounting points should be even with the shoulders such that the straps make an angle of 10° to the horizontal.

The mounting points must be equally disposed about the user's centreline so that straps spread inward slightly from the mountings and around the FHRs.

This helps to keep the straps firmly engaged with the FHRs.

#### How do I care for my head restraint?

HANS and Hybrid head restraints are low maintenance but should be kept clean and dry.

Extreme hot or cold environments should be avoided, and they should be kept away from petroleum products and other corrosives which can affect even the strongest composite materials and resins. Store out of direct sunlight and clean when needed with soapy warm water.



CALL US AT 1-800-654-7223 FOR HANS AND HYBRID ASSISTANCE.

### Restraint System Mounting Zones (Side View)

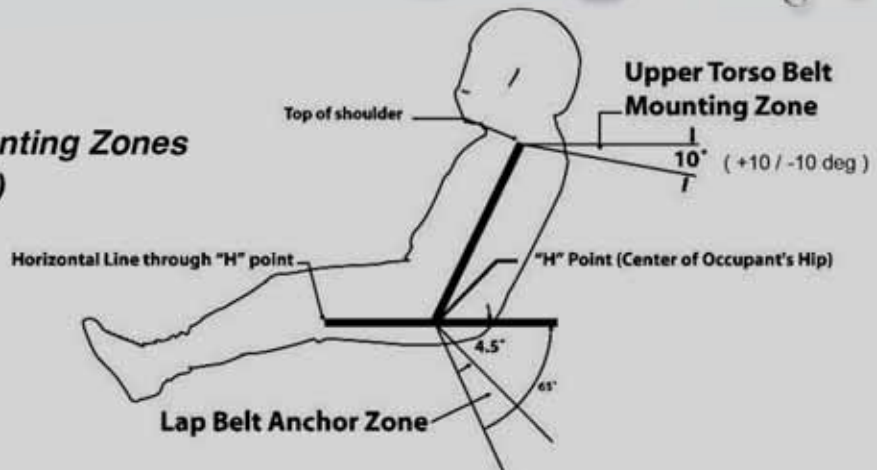

# HEAD RESTRAINTS

## HYBRID PRO LITE

The Hybrid Pro Lite® is the ultimate in safety and comfort. The Hybrid Pro Lite's new lightweight design and carbon fiber construction provides maximum comfort and maneuverability with superior strength. All of Simpson's Hybrid Series head restraints are designed for easily exiting the car without the danger of being entangled in other gear by offering the lowest profile of any comparable device. This device comes with optional patented SAS (Seatbelt Anchor System) for even greater coverage in flips, barrel rolls and side impacts. When the worst happens, you'll have the same great protection every time.

SHOWN WITH  
M6 ANCHOR OPTION



ALEC HOHNADSELL,  
FORMULA DRIFT DRIVER, HUDDY RACING



|                      |                       |                           |
|----------------------|-----------------------|---------------------------|
| CODE:<br><b>HYPL</b> | SIZE:<br><b>XS-XL</b> | PRICE:<br><b>\$995.00</b> |
|----------------------|-----------------------|---------------------------|

|                      |                              |                             |
|----------------------|------------------------------|-----------------------------|
| CODE:<br><b>HYPL</b> | SIZE:<br><b>XS-XL W/ SAS</b> | PRICE:<br><b>\$1,035.00</b> |
|----------------------|------------------------------|-----------------------------|

### FEATURES

Ships race ready with Quick release and D-ring Helmet Anchors

### UPGRADES

- Post Anchors/ Tether Kit - \$65
- M61 Quick Release/Dual End Tether Kit - \$65
- Seatbelt Anchor System - \$40
- Quick Click Anchors/Tether Kit - \$65



## HYBRID PRO X PACKAGE

### NHRA TOP FUEL AND FUNNY CAR

The Hybrid X package is designed for drag racing's extreme speeds and includes the Hybrid Pro Head Restraint with SAS, specially fitted with the double chin strap "W" style and a semi-rigid neck collar constructed of SFI 45.2 approved padding. The X package provides extreme protection and support and features six tethers connecting to 4 points on the helmet. The Hybrid Pro with X package is worn by top NHRA racers, including John Force and Robert Hight. Includes a Hybrid Pro, double chin strap and semi-rigid neck collar.



|                          |   |                             |
|--------------------------|---|-----------------------------|
| CODE:<br><b>HR.X.PKG</b> | SIZE:<br><b>XS-XL, CUSTOM AVAILABLE</b> | PRICE:<br><b>\$1,195.00</b> |
|--------------------------|---|-----------------------------|

### UPGRADE

- Quick Click Anchors/Tether Kit - \$65
- Post Anchors/Tether Kit - \$65
- M61 Quick Release/Dual End Tether Kit - \$65



SEMI-RIGID NECK COLLAR



DOUBLE CHIN STRAP



## HYBRID SPORT

The Hybrid Sport® is a great head restraint device for those racing on a budget. The Hybrid Sport with its new lightweight design and DuPont® carbon/polymer construction provides maximum comfort and maneuverability with superior strength. All of Simpson's Hybrid Series head restraints are designed for easily exiting the car without the danger of being entangled in other gear by offering the lowest profile of any comparable device. This device comes with optional patented SAS (Seatbelt Anchor System) for even greater coverage in flips, barrel rolls and side impacts. When the worst happens, you'll have the same great protection every time.



|                    |                       |                           |
|--------------------|-----------------------|---------------------------|
| CODE:<br><b>HS</b> | SIZE:<br><b>XS-XL</b> | PRICE:<br><b>\$599.00</b> |
|--------------------|-----------------------|---------------------------|

|                    |                              |                           |
|--------------------|------------------------------|---------------------------|
| CODE:<br><b>HS</b> | SIZE:<br><b>XS-XL W/ SAS</b> | PRICE:<br><b>\$639.00</b> |
|--------------------|------------------------------|---------------------------|

### FEATURES

Ships race ready with Quick release and D-ring Helmet Anchors

### UPGRADES

- Post Anchors/Tether Kit - \$65
- M61 Quick Release/Dual End Tether Kit - \$65
- Seatbelt Anchor System - \$40
- Quick Click Anchors/Tether Kit - \$65

SHOWN WITH  
M6 ANCHOR OPTION

## HYBRID SPORT YOUTH

The Hybrid Sport® Jr. sizes give you all the safety as an Adult version, but 25% smaller to fit a Youth as young as 4 years. The Hybrid Sport with its lightweight design and DuPont® carbon/polymer construction provides maximum comfort and maneuverability with superior strength. All of Simpson's Hybrid Series head restraints are designed for easily exiting the car without the danger of being entangled in other gear by offering the lowest profile of any comparable device. This device comes with optional patented SAS (Seatbelt Anchor System) for even greater coverage in flips, barrel rolls and side impacts. When the worst happens, you'll have the same great protection every time.



| Hybrid Sport Youth |      |  |  |       |
|--------------------|------|--|--|-------|
| CODE               | FITS |  |  | PRICE |

|        |          |        |            |          |
|--------|----------|--------|------------|----------|
| HS.XSC | XS/CHILD | 22-26" | 4-6 YEARS  | \$429.00 |
| HS.CHD | CHILD    | 22-26" | 7-9 YEARS  | \$429.00 |
| HS.YTH | YOUTH    | 26-30" | 9-12 YEARS | \$429.00 |

Age ranges are meant as a guide; if in doubt call 1-800-654-7223 for assistance.

### FEATURES

Ships race ready with Quick release and D-ring Helmet Anchors.

Hybrid Sport Jr. Sizes come with Fixed-length back tethers:

XSC: 10" | CHD: 11" | Youth: 12"

### UPGRADES

- Post Anchors/ Tether Kit - \$65
- M61 Quick Release/Dual End Tether Kit - \$65
- Seatbelt Anchor System - \$40
- Quick Click Anchors/Tether Kit - \$65

RECOMMENDED FOR  
QUARTER MIDGET RACING

# HEAD RESTRAINTS

**Hybrid S** HOT PRODUCT



Simpson's Hybrid S model is currently the only Frontal Head Restraint proven effective for 3-point harnesses, and the device is also FIA and SFI approved. Additionally, in a partnership with Detroit auto manufacturers, the Hybrid S is third party tested to FMVSS208.

The Hybrid S allows high-performance driving Instructors, auto manufacturing test engineers, and other drivers with 3-point harnesses access to the advantages of head restraint safety.

The FIA Hybrid Head Restraint, in conjunction with a Snell or FIA rated helmet and a 3-point harness, reduced neck tension significantly when compared to a test with only a helmet and 3-point harness.

While we can offer head restraint protection for use with 3-point seatbelts, Simpson's top concern is driver and instructor safety. We suggest a Full Containment Cockpit System that includes a Full Containment Seat, Snell or FIA rated Helmet, FIA or SFI approved Frontal Head Restraint, and a 5 to 7-point seatbelt harness system for the best protection while on the track.

## FEATURES

- FIA approved, SFI certified
- High-quality carbon fiber construction
- Low profile. No high back to hook on the bars on exit.
- Multiple load paths to dissipate head loads
- Buckle attachment in front. No bulky straps underneath.
- Ships race ready with post clips
- Seat belt anchor system
- Helmet anchors available for upgrade

| Hybrid S |  |            |
|----------|--|------------|
| CODE     | FITS   | PRICE      |
| HYS.PA   | POST ANCHORS, ALL SIZES, W/O HELMET ANCHORS        | \$1,095.00 |
| HYS.M61  | M61 UPGRADE OPTION, ALL SIZES, WITH HELMET ANCHORS | \$1,160.00 |



3 Point OEM  
Harness Compatible

**PROTECTION STATEMENT** *Simpson's top concern is your safety. For your BEST protection on the racetrack, we suggest a full containment cockpit system that includes a full containment seat, Snell or FIA rated helmet, SFI or FIA approved head restraint and a 5, 6 or 7-point harness system.*

For best safety practices, it is our recommendation that no one should unhook/disable the airbag system installed by the auto manufacturer or their authorized installer. Our outside experts in Detroit confirmed and require their test engineers to use the Hybrid S in conjunction with the airbag in a 3-point system. All of our experts believe the airbag and Hybrid S work in conjunction to increase protection in frontal crash events.

## OPTIONAL HELMET ACCESSORIES AND TETHERS FOR SIMPSON HYBRID

### M61 DUAL END FITTING TETHER-PAIR

Used with M6 Anchor System.

CODE: **HS.M61.DE**  
PRICE: **\$39.00**



### HYBRID POST CLIPS-PAIR

CODE: **HS.PA**  
**HY.PA**  
PRICE: **\$39.00**  
**\$39.00**



### QUICK RELEASE ASSEMBLY

Used with D rings.

CODE: **HS.QR (1 SIDE)**  
**HY.QR (1 SIDE)**  
PRICE: **\$39.00**  
**\$39.00**



### HY QUICK CLICK LOOP

CODE: **HS.QC**  
**HY.QC**  
PRICE: **\$39.00**  
**\$39.00**



### ADJUSTABLE SLIDING TETHER

Used with Simpson Head Restraints.

CODE: **HR.STK.L**  
PRICE: **\$29.00**



## OPTIONAL HELMET ANCHOR

### M6 ANCHOR

CODE: **M61.HAK**  
**M61.HAK.SAH W/O WASHERS**  
PRICE: **\$70.00**  
**\$65.00**



### SIMPSON POST ANCHORS PAIR

CODE: **PA.HAK**  
**PA.HAK.SAH W/O WASHERS**  
PRICE: **\$70.00**  
**\$65.00**



### D-RINGS

CODE: **SFI.DRK**  
**SFI.DRK.SAH**  
PRICE: **\$27.00**  
**\$25.00**



### SIMPSON QUICK CLICK SYSTEM

CODE: **QC.HAK**  
**QC.HAK.SAH W/O WASHERS**  
PRICE: **\$85.00**  
**\$80.00**



# HEAD RESTRAINTS

## HYBRID SIZING CHART

### CHEST STRAP WITH DRIVING SUIT ON

#### HOW TO MEASURE

1. Measure around chest below pectoral muscles.
2. Measure with driving suit. If not available add 1" to measurement.
3. Take measurement with tape placed against driver without any slack and without pulling the tape tight.
4. Once measurement has been determined, refer to size charts to device size selection.

Call customer service at **800-654-7223** if unsure.

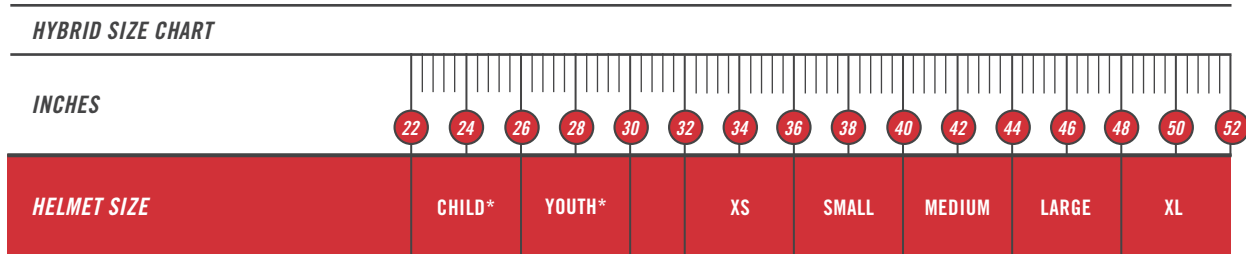

\* CHILD AND YOUTH SIZES AVAILABLE IN HYBRID SPORT

## HANS DEVICE SIZING CHART

Neck size is the starting point for fitting a HANS Device.  
You may fit several sizes – comfort is the deciding factor. See HANS selection, beginning page 37.

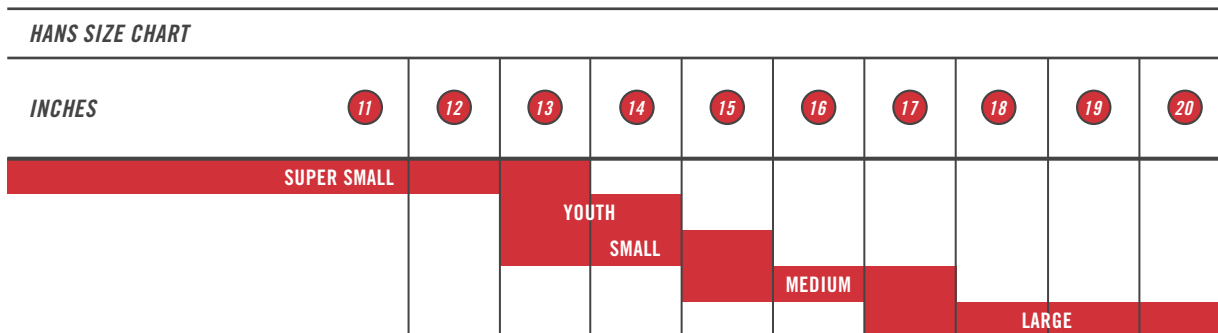



## HANS III



The HANS III represents the third generation of injection molded HANS devices and takes a revolutionary approach to reducing weight. Using an all-new design and polymer, the HANS III features a hollow collar to substantially minimize weight. Engineered reinforcements ensure this HANS offers the same level of safety as every HANS device, while the reduced mass guarantees the lightest, most comfortable injection molded HANS ever. Call for FIA pricing.

### Hans III

| CODE             | SIZE                                 | PRICE    |
|------------------|--------------------------------------|----------|
| DK 14237.311 SFI | 20 MEDIUM, PA SLIDING SAH, SFI       | \$449.00 |
| DK 14237.321 SFI | 20 MEDIUM, PA SLIDING, SFI           | \$449.00 |
| DK 14237.411 SFI | 20 MEDIUM, QUICK CLICK, SAH, SFI     | \$449.00 |
| DK 14237.421 SFI | 20 MEDIUM, QUICK CLICK, SLIDING, SFI | \$449.00 |
| DK 14247.311 SFI | 20 LARGE, PA SLIDING SAH, SFI        | \$449.00 |
| DK 14247.321 SFI | 20 LARGE, PA SLIDING, SFI            | \$449.00 |
| DK 14247.411 SFI | 20 LARGE, QUICK CLICK, SAH, SFI      | \$449.00 |
| DK 14247.421 SFI | 20 LARGE, QUICK CLICK, SLIDING, SFI  | \$449.00 |

### FOR LAYDOWN CARS

|                  |   |          |
|------------------|---|----------|
| DK 18337.311 SFI | 30 MEDIUM, PA SLIDING, SAH, SFI           | \$549.00 |
| DK 18337.321 SFI | 30 MEDIUM, PA SLIDING, SA, SFI            | \$549.00 |
| DK 18337.411 SFI | 30 MEDIUM, QUICK CLICK, SLIDING, SAH, SFI | \$549.00 |
| DK 18337.421 SFI | 30 MEDIUM, QUICK CLICK, SLIDING, SA, SFI  | \$549.00 |
| DK 18347.311 SFI | 30 LARGE, PA SLIDING, SAH, SFI            | \$549.00 |
| DK 18347.321 SFI | 30 LARGE, PA SLIDING, SA, SFI             | \$549.00 |
| DK 18347.411 SFI | 30 LARGE, QUICK CLICK, SLIDING, SAH, SFI  | \$549.00 |
| DK 18347.421 SFI | 30 LARGE, QUICK CLICK, SLIDING, SA, SFI   | \$549.00 |

## HANS PRO ULTRA

### NASCAR APPROVED

The HANS Pro Ultra is SFI 38.1 and NASCAR approved. The Pro Ultra device applies lightweight construction of the Carbon Fiber Pro series to the modern new shape of the Sport II. The Ultra saves on weight and allows for easy entry and exit from the race car, even smaller, tighter vehicles. The 100% carbon fiber construction features a hollow core for increased weight reduction without sacrificing strength. The sliding tethers offer exceptional visibility. Upgrade to the Pro Ultra today.



### Hans Pro Ultra

| CODE            | SIZE  | PRICE    |
|-----------------|---|----------|
| DK 13235.31 SFI | 20M PRO ULTRA, PA SLIDING FOR SAH HELMET, SFI | \$979.00 |
| DK 13235.32 SFI | 20M PRO ULTRA, PA SLIDING FOR SA HELMET, SFI  | \$979.00 |
| DK 13235.41 SFI | 20M PRO ULTRA, QC SLIDING FOR SAH HELMET, SFI | \$979.00 |
| DK 13235.42 SFI | 20M PRO ULTRA, QC SLIDING FOR SA HELMET, SFI  | \$979.00 |
| DK 13245.31 SFI | 20L PRO ULTRA, PA SLIDING FOR SAH HELMET, SFI | \$979.00 |
| DK 13245.32 SFI | 20L PRO ULTRA, PA SLIDING FOR SA HELMET, SFI  | \$979.00 |
| DK 13245.41 SFI | 20L PRO ULTRA, QC SLIDING FOR SAH HELMET, SFI | \$979.00 |
| DK 13245.42 SFI | 20L PRO ULTRA, QC SLIDING FOR SA HELMET, SFI  | \$979.00 |

### FOR LAYDOWN CARS

|                 |  |            |
|-----------------|--|------------|
| DK 13335.31 SFI | 30M, PRO ULTRA, PA SLIDING FOR SAH HELMET, SFI | \$1,079.00 |
| DK 13335.32 SFI | 30M, PRO ULTRA, PA SLIDING FOR SA HELMET, SFI  | \$1,079.00 |
| DK 13335.41 SFI | 30M, PRO ULTRA, QC SLIDING FOR SAH HELMET, SFI | \$1,079.00 |
| DK 13335.42 SFI | 30M, PRO ULTRA, QC SLIDING FOR SA HELMET, SFI  | \$1,079.00 |

## YOUTH HANS III



The lightweight HANS III is now available in a Youth size. The SFI 38.1 certified HANS III Youth features a hollow collar that substantially minimizes weight and is engineered for the growing young racer. Reinforcements ensure an exceptionally strong structure that provides the same level of safety as every HANS device.

See sizing chart for recommendations – remember driver comfort is the most important factor when choosing a size.

### Youth Hans III

| CODE             | SIZE                        | PRICE    |
|------------------|-----------------------------|----------|
| DK 16217.311 SFI | 20, PA SLIDING FOR SAH, SFI | \$429.00 |
| DK 16217.321 SFI | 20, PA SLIDING FOR SA, SFI  | \$429.00 |
| DK 16217.411 SFI | 20, QC SLIDING FOR SAH, SFI | \$429.00 |
| DK 16217.421 SFI | 20, QC SLIDING FOR SA, SFI  | \$429.00 |

# HEAD RESTRAINTS



## HANS ADJUSTABLE SERIES



This head and neck restraint from HANS promises to be a great addition to the head restraint market with an adjustable feature for those racers who want a customized comfort level. Call for FIA pricing.

| Hans Adjustable Series |   |          |
|------------------------|---|----------|
| CODE                   | SIZE  | PRICE    |
| DK 13034.32 SFI        | MEDIUM ADJUSTABLE DEVICE WITH SLIDING TETHERS & PROF. POST ANCHORS  | \$549.00 |
| DK 13034.42 SFI        | MEDIUM ADJUSTABLE DEVICE WITH SLIDING TETHERS & QUICK CLICK ANCHORS | \$549.00 |

### FEATURES

- Device adjusts in 5 degree increments, from 10 to 40 degrees
- Fits all types of race cars and seats
- Ships with complete instructions plus tools to adjust device

## HANS PRO ULTRA LITE



The HANS Pro Ultra Lite is SFI 38.1 and FIA approved. The Pro Ultra device applies aerospace grade carbon to achieve a 100+ gram weight saving compared to the regular Ultra. The Ultra Lite saves on weight and allows for easy entry and exit from the race car, even smaller, tighter vehicles. The 100% carbon fiber construction features a hollow core for increased weight reduction without sacrificing strength. The sliding tethers offer exceptional visibility. Call for FIA pricing. Upgrade to the Pro Ultra Lite today.



| HANS Pro Ultra Lite |                                     |            |
|---------------------|-------------------------------------|------------|
| CODE                | SIZE                                | PRICE      |
| DK 14236.31 SFI     | 20M, PA SLIDING FOR SAH HELMET, SFI | \$999.00   |
| DK 14236.32 SFI     | 20M, PA SLIDING FOR SA HELMET, SFI  | \$999.00   |
| DK 14236.41 SFI     | 20M, QC SLIDING FOR SAH HELMET, SFI | \$999.00   |
| DK 14236.42 SFI     | 20M, QC SLIDING FOR SA HELMET, SFI  | \$999.00   |
| DK 14246.31 SFI     | 20L, PA SLIDING FOR SAH HELMET, SFI | \$999.00   |
| DK 14246.32 SFI     | 20L, PA SLIDING FOR SA HELMET, SFI  | \$999.00   |
| DK 14246.41 SFI     | 20L, QC SLIDING FOR SAH HELMET, SFI | \$999.00   |
| DK 14246.42 SFI     | 20L, QC SLIDING FOR SA HELMET, SFI  | \$999.00   |
| FOR LAYDOWN CARS    |                                     |            |
| DK 16336.31 SFI     | 30M, PA SLIDING FOR SAH HELMET, SFI | \$1,099.00 |
| DK 16336.32 SFI     | 30M, PA SLIDING FOR SA HELMET, SFI  | \$1,099.00 |
| DK 16336.41 SFI     | 30M, QC SLIDING FOR SAH HELMET, SFI | \$1,099.00 |
| DK 16336.42 SFI     | 30M, QC SLIDING FOR SA HELMET, SFI  | \$1,099.00 |

## HOT NEW PRODUCT HANS ZERO



The Stilo HANS Zero combines the best of the Simpson Group, a fresh Italian design engineered for extreme lightness along with HANS proven technology to create the lightest, most comfortable HANS device ever. Using proprietary techniques and aerospace grade carbon fiber, the Stilo HANS Zero is 15% lighter than the HANS Ultra Lite, the current lightest HANS on the market. The Zero's legs are carefully crafted to fit your chest and the result is pure comfort! You will know you're wearing the best head and neck protection available.

Stilo HANS Zero is the ultimate achievement from the company that invented head and neck restraints, a collaboration of excellence combining Stilo's best of Italian style and HANS lifesaving technology.



PRODUCT AVAILABLE EARLY 2019

MSRP  
\$1,399.00

## HANS PROFESSIONAL SERIES NASCAR APPROVED



Professional HANS devices are lightweight handlaid carbon fiber. The HANS Professional device is worn by professional racers worldwide, including NASCAR's finest racers like Jimmie Johnson, Tony Stewart and Denny Hamlin. Call for FIA pricing.

### FEATURES

**The Model 20**, our most popular angle, fits upright seats like those found in most sports cars, from Honda to Lamborghini. Fits most stock cars, drag cars, sprints, modifieds and similar. Available in 4 sizes – Super Small (youth), Small, Medium, Large.

**The Model 10** fits extreme upright seats like those found in sprint cars. It also is comfortable for some very thin drivers. Model 10 available in size Medium only.

**The Model 30** fits laydown seats like some Formula cars. It also is comfortable for larger drivers in sports cars in place of a Model 20. Available in size Large only.

**The Model 40** – special order for vintage single seaters only. Available in size Medium only.



### Hans Professional Series

| CODE             | SIZE                                    | PRICE      |
|------------------|---|------------|
| DK 11211.321 SFI | SUPER SMALL 20 PRO, PA SLIDING          | \$949.00   |
| DK 11211.421 SFI | SUPER SMALL 20 PRO, QUICK CLICK SLIDING | \$949.00   |
| DK 11221.321 SFI | SMALL 20 PRO, PA, SLIDING               | \$949.00   |
| DK 11221.421 SFI | SMALL 20 PRO, QUICK CLICK, SLIDING      | \$949.00   |
| DK 11131.321 SFI | MEDIUM 10 PRO, PA, SLIDING              | \$1,049.00 |
| DK 11131.421 SFI | MEDIUM 10 PRO, QUICK CLICK SLIDING      | \$1,049.00 |
| DK 11231.321 SFI | MEDIUM 20 PRO, PA, SLIDING              | \$949.00   |
| DK 11231.421 SFI | MEDIUM 20 PRO, QUICK CLICK              | \$949.00   |
| DK 11431.321 SFI | MEDIUM 40 PRO                           | CALL       |
| DK 11241.321 SFI | LARGE 20 PRO, PA, SLIDING               | \$949.00   |
| DK 11241.421 SFI | LARGE 20 PRO, QUICK CLICK, SLIDING      | \$949.00   |
| DK 11341.321 SFI | LARGE 30 PRO, PA, SLIDING               | \$1,049.00 |
| DK 11341.421 SFI | LARGE 30 PRO, QUICK CLICK, SLIDING      | \$1,049.00 |

# HEAD RESTRAINTS

## HANS ACCESSORIES

### POST COLLAR ANCHOR

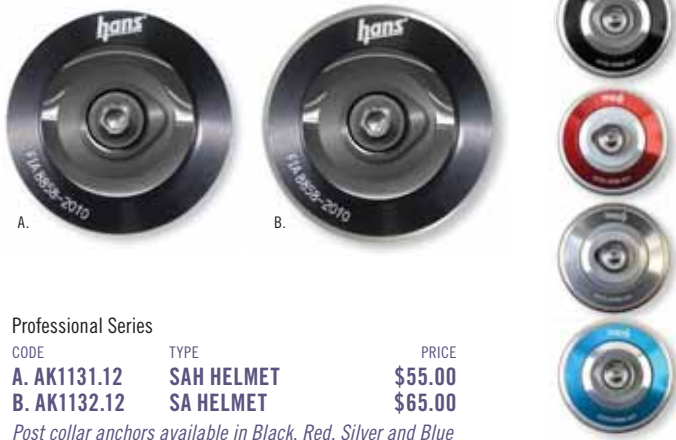

#### Professional Series

| CODE         | TYPE       | PRICE   |
|--------------|------------|---------|
| A. AK1131.12 | SAH HELMET | \$55.00 |
| B. AK1132.12 | SA HELMET  | \$65.00 |

Post collar anchors available in Black, Red, Silver and Blue

### M61 SINGLE END FITTING TETHER-PAIR

Used with M6 Anchor System

| CODE     | Type   | Price   |
|----------|--|---------|
| TK1451.3 | SPORT II                                     | \$40.00 |
| TK1451.4 | ADJUSTABLE, PRO ULTRA, PROFESSIONAL, SPORT 1 | \$40.00 |
| TK1451.7 | HANS III                                     | \$40.00 |



### QUICK CLICK ATTACHMENT

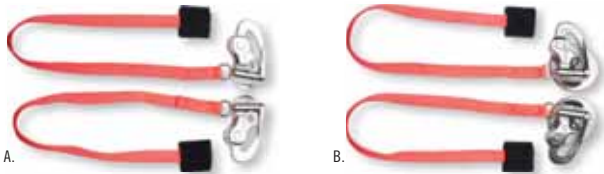

| CODE        | TYPE                                | PRICE   |
|-------------|-------------------------------------|---------|
| A. AK1141.2 | FITS SAH HELMET WITHOUT NUT WASHERS | \$70.00 |
| B. AK1142.2 | FITS SA HELMET                      | \$80.00 |

### M6 ANCHOR



| CODE                    | TYPE | PRICE   |
|-------------------------|------|---------|
| M61.HAK                 |      | \$70.00 |
| M61.HAK.SAH, WO WASHERS |      | \$65.00 |

### SLIDING TETHER FOR POST COLLAR ANCHOR



| CODE     | TYPE  | PRICE   |
|----------|---|---------|
| TK1131.3 | SPORT II  | \$40.00 |
| TK1231.4 | ADJUSTABLE, PRO ULTRA, PROFESSIONAL AND SPORT 1 (Shown) | \$40.00 |
| TK1431.7 | HANS III  | \$40.00 |

### SLIDING TETHER FOR QUICK-CLICK ANCHOR



| CODE     | TYPE  | PRICE   |
|----------|---|---------|
| TK1141.3 | SPORT II  | \$20.00 |
| TK1241.4 | ADJUSTABLE, PRO ULTRA, PROFESSIONAL AND SPORT 1 (Shown) | \$20.00 |
| TK1441.7 | HANS III  | \$20.00 |

### PADDING



| CODE | TYPE     | PRICE   |
|------|----------|---------|
| K9   | GEL KIT  | \$80.00 |
| K9   | FOAM KIT | \$60.00 |

Colors: Black, Blue, Red, Yellow

### HANS BAG

Preformed bag protects your HANS from sunlight and scuffing



| CODE  | TYPE     | PRICE  |
|-------|----------|--------|
| 23909 | HANS BAG | \$9.99 |



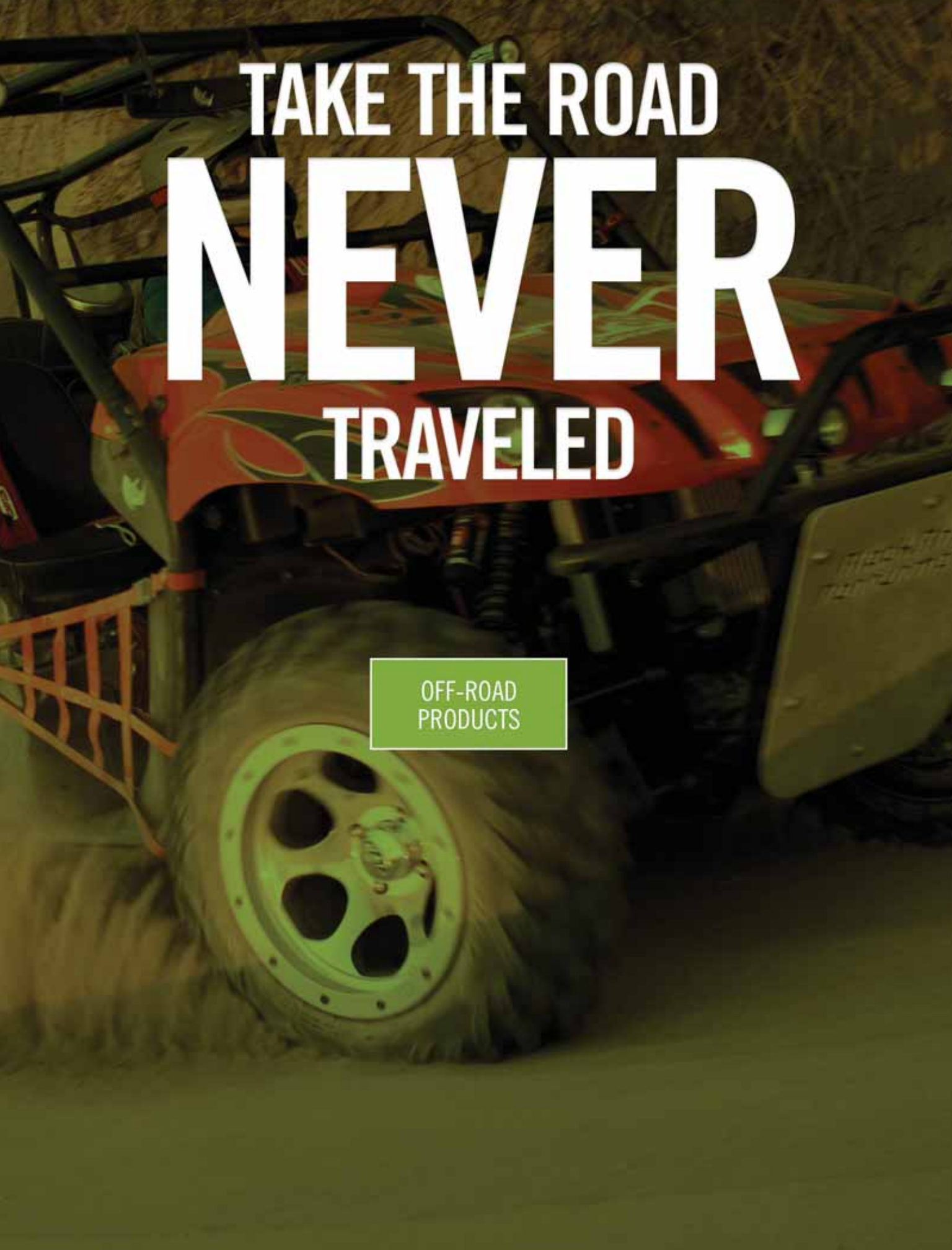

# TAKE THE ROAD NEVER TRAVELED

OFF-ROAD  
PRODUCTS



## UTV SPORT STYLE SUIT



UTV Suit features our popular 3 stripe retro styling  
 One-piece suit meets and exceeds SFI 3.2A/1 and SFI 5 3.2/5 requirements  
 Black Ankle and Wrist Cuffs  
 Standard Shoulder Epaulets  
 Red, Orange and Yellow racing stripes on driving suit arms

### SIZES

Small – XXLarge, 15% upcharge for XXL

### COLOR

Black Only

| CODE:     | SIZE:                  | BASE PRICE:     |
|-----------|------------------------|-----------------|
| <b>U3</b> | <b>SFI 3.2/1 RATED</b> | <b>\$319.95</b> |
| <b>U4</b> | <b>SFI 3.2/5 RATED</b> | <b>\$529.95</b> |



## NEW DESERT DEVIL

The Desert Devil Off-Road Helmet System includes our popular Devil Ray Snell SA 2015 rated helmet, equipped with an offset top air pipe and off-road communication kit. Pop the helmet out of the box and you are ready to go riding.

The off-road communications kit comes with a 3.5mm headphone connection that can be plugged into your mobile phone for music using an auxiliary cord easily purchased from your favorite electronics store. The offset top air pipe gives extra head clearance in the vehicle.



| CODE:      | TYPE:                     | SIZE:         | PRICE:            |
|------------|---------------------------|---------------|-------------------|
| <b>682</b> | <b>WHITE, GLOSS BLACK</b> | <b>XS-XXL</b> | <b>\$649.95</b>   |
| <b>682</b> | <b>CARBON FIBER</b>       | <b>XS-XXL</b> | <b>\$1,129.95</b> |

### RECOMMENDED FOR REPLACEMENT SHIELDS 84300 SERIES

|              | CODE:  | COLOR:  | PRICE:  |
|--------------|--------|---------|---------|
| Circle Track | 84300A | CLEAR   | \$49.95 |
| Dirt Track   | 84301A | SMOKE   | \$49.95 |
| Off-Road     | 84303  | IRIDIUM | \$69.95 |
| Road Racing  | 84304A | AMBER   | \$59.95 |
|              | 84306A | MIRROR  | \$69.95 |

### COLORS

White, Gloss Black, and Carbon fiber



## VORTEX

The Vortex seat provides high containment while still allowing for easy entry and exit with its cutaway lower bolster design. It is designed to work with the factory slider without raising the seat height. The Vortex's traditional tube-style frame is mated to a laser cut seat base which utilizes a variety of different modular mounting rails. Optional seat heaters and adjustable lumbar supports are available.

The Vortex model is available in 3 sizes:

1. Standard size
2. Wide Body (2" wider, Retail \$499.95)
3. Short Cushion (the base is 2" shorter front to back)



BLACK/RED

### Vortex

| CODE    | TYPE                  | PRICE    |
|---------|-----------------------|----------|
| 101-304 | VORTEX BLACK/BLACK    | \$479.95 |
| 101-305 | VORTEX BLACK/CHARCOAL | \$479.95 |
| 101-306 | VORTEX BLACK/RED      | \$479.95 |
| 101-308 | VORTEX BLACK/ORANGE   | \$479.95 |
| 101-317 | VORTEX BLACK/LT BLUE  | \$479.95 |
| 101-CUS | VORTEX CUSTOM         | \$529.95 |

\*THE VORTEX MODULAR DESIGN FITS SEVERAL VEHICLES. MOUNTS ARE NOT INCLUDED AND MUST BE PURCHASED SEPARATELY. SEE PAGE 50.

SEAT MEASUREMENTS ARE LOCATED ON PAGE 51



CUSTOM  
VORTEX

### SPECIAL EDITION BLACKOUT VORTEX



BLACK/LT BLUE



BLACK/CHARCOAL



BLACK/ORANGE

## VORTEX REAR BENCH



The Vortex rear bench is completely bolt-in. It does not require any cutting or permanent modifications to install and utilizes a laser cut panel to replace the factory plastic console. The rear bench matches the styling of the new Vortex and can be ordered in colors that complement the factory front seat for those who do not want to replace the OEM front seats. Optional seat heaters and adjustable lumbar supports are available.



### Vortex Rear Bench

| CODE        | TYPE                             | PRICE    |
|-------------|----------------------------------|----------|
| 116-510-305 | VORTEX REAR BENCH BLACK/CHARCOAL | \$899.95 |
| 116-510-306 | VORTEX REAR BENCH BLACK/RED      | \$899.95 |
| 116-510-307 | VORTEX REAR BENCH BLACK/BLUE     | \$899.95 |
| 116-510-308 | VORTEX REAR BENCH BLACK/ORANGE   | \$899.95 |
| 116-510-309 | VORTEX REAR BENCH BLACK/SILVER   | \$899.95 |
| 116-510-316 | VORTEX REAR BENCH BLACK/WHITE    | \$899.95 |
| 116-510-317 | VORTEX REAR BENCH BLACK/LT BLUE  | \$899.95 |
| 116-510-CUS | VORTEX REAR BENCH CUSTOM         | \$949.95 |

\*ABOVE PART NUMBERS FIT XP 4 1000, XP 4 TURBO, 2015 + XP 4 900

\*\*ALSO AVAILABLE FOR 2010-2014 RZR 4 800/900

SEAT MEASUREMENTS ARE LOCATED ON PAGE 51

## CAN AM X3 VORTEX BENCH



The new Can Am X3 Vortex bench is 4" wider than our standard Vortex bench, making it the perfect size for the X3. All Vortex rear benches are completely bolt-in and come with all the required hardware needed for installation. It can be ordered in colors that complement the factory front seat for those who do not want to replace the OEM front seats.



### Can Am X3 Vortex Bench

| CODE        | TYPE                             | PRICE    |
|-------------|----------------------------------|----------|
| 303-510-304 | VORTEX REAR BENCH BLACK/BLACK    | \$940.95 |
| 303-510-305 | VORTEX REAR BENCH BLACK/CHARCOAL | \$940.95 |
| 303-510-306 | VORTEX REAR BENCH BLACK/RED      | \$940.95 |
| 303-510-308 | VORTEX REAR BENCH BLACK/ORANGE   | \$940.95 |
| 303-510-317 | VORTEX REAR BENCH BLACK/LT BLUE  | \$940.95 |
| 303-510-303 | VORTEX REAR BENCH BLACK/FIRE RED | \$940.95 |
| 303-510-CUS | VORTEX REAR BENCH CUSTOM         | \$990.95 |

\*ABOVE PART NUMBERS FIT XP 4 1000, XP 4 TURBO, 2015 + XP 4 900

\*\*ALSO AVAILABLE FOR 2010-2014 RZR 4 800/900

SEAT MEASUREMENTS ARE LOCATED ON PAGE 51

**CUSTOM**  
MATTE BLACK, CARBON FIBER BLACK  
WITH FIRE RED ACCENTS



## PRO SPORT

The Pro Sport was developed and engineered for superior fit, function, comfort and style all while keeping its mounting position as low as possible in the vehicle. The Pro Sport is 2" wider than our standard Vortex in key areas with extra broad shoulders for the ultimate comfort and containment. Its base is made up of our laser-cut universal pan design making it ideal for UTVs, Buggies, Jeeps and most all off-road vehicles. Optional seat heaters and adjustable lumbar supports are available.



BLACK/LT BLUE/GREY

### Pro Sport

| CODE    | TYPE                       | PRICE    |
|---------|----------------------------|----------|
| 106-304 | PRO SPORT BLK/BLK          | \$579.95 |
| 106-305 | PRO SPORT BLK/CHAR/GREY    | \$579.95 |
| 106-306 | PRO SPORT BLK/RED/GREY     | \$579.95 |
| 106-308 | PRO SPORT BLK/ORG/GREY     | \$579.95 |
| 106-317 | PRO SPORT BLK/LT BLUE/GREY | \$579.95 |
| 106-CUS | PRO SPORT CUSTOM           | \$629.95 |

\*THE PRO SPORT MODULAR DESIGN FITS SEVERAL VEHICLES. MOUNTS ARE NOT INCLUDED AND MUST BE PURCHASED SEPARATELY. SEE PAGE 50.

SEAT MEASUREMENTS ARE LOCATED ON PAGE 51

## CUSTOM PRO SPORT



## SPECIAL EDITION BLACKOUT PRO SPORT



BLACK/RED/GREY



BLACK/ORANGE/GREY



BLACK/CHARCOAL/GREY

## 170 AGGRESSOR

### ALL NEW RE-ENGINEERED DESIGN FOR IMPROVED PERFORMANCE

The 170 Aggressor has been engineered to provide superior containment in conjunction with a 5 point harness. It is available in three different color options or it can be customized to order in a wide variety of colors and materials to complement your car.



BLACK/LT BLUE/WHITE



### 170 Aggressor

| CODE    | TYPE  | PRICE    |
|---------|---|----------|
| 110-304 | 170 AGGRESSOR M BLACK/BLACK/C FIBER         | \$325.95 |
| 110-305 | 170 AGGRESSOR M BLACK/GREY/WHITE/C FIBER    | \$325.95 |
| 110-306 | 170 AGGRESSOR M BLACK/RED/WHITE/C FIBER     | \$325.95 |
| 110-317 | 170 AGGRESSOR M BLACK/LT BLUE/WHITE/C FIBER | \$325.95 |
| 110-CUS | 170 AGGRESSOR CUSTOM                        | \$375.95 |

\*MOUNTS ARE NOT INCLUDED AND MUST BE PURCHASED SEPARATELY. SEE PAGE 50.

SEAT MEASUREMENTS ARE LOCATED ON PAGE 51



BLACK/RED/WHITE



BLACK/GREY/WHITE



CUSTOM COLORS

## XL-R

The XL-R was designed with the Jeep daily driver in mind with its reclining backrest and easy exit/entry bolster design. The reclining function allows you to fine-tune the comfort level and provides easy backseat access. Like all of our seats, the XL-R is a suspension seat and is built with the highest quality materials. The XL-R adds comfort, safety and style to any ride.



CUSTOM COLORS



### XL-R (Reclining Universal Tab Mounted)

| CODE        | TYPE  | PRICE    |
|-------------|---|----------|
| 505-108-101 | XL-R ALL MATTE BLACK                                    | \$549.95 |
| 505-108-500 | XL-R XCEL BLACK CLOTH/MATTE BLACK                       | \$549.95 |
| 505-108-105 | XL-R MATTE BLACK/CARBON FIBER BLACK                     | \$549.95 |
| 505-108-106 | XL-R MATTE BLACK/CARBON FIBER BLACK/RED                 | \$549.95 |
| 505-108-107 | XL-R MATTE BLACK/CARBON FIBER BLACK/BLUE                | \$549.95 |
| 505-108-108 | XL-R MATTE BLACK/CARBON FIBER BLACK/ORANGE              | \$549.95 |
| 505-108-109 | XL-R MATTE BLACK/CARBON FIBER BLACK/CARBON FIBER SILVER | \$549.95 |
| 505-108-CUS | XL-R CUSTOM   | \$599.95 |

SEAT MEASUREMENTS ARE LOCATED ON PAGE 51

MATTE BLACK





## OFF-ROAD D3 RESTRAINT

The Simpson D3 buckle does what no other buckle system can. It provides the ease and convenience of a sewn-in harness without the shoulder straps being sewn to the lap belt. Its unique patented design eliminates the two shoulder strap links while still allowing the shoulder straps to be joined at the center of the buckle, truly emulating the "V" shape of a 5 point latch and link.

\*To order a D3 harness with cadmium plated hardware, remove the "X" from the end of the part number. Shoulder speed adjusters are not available with cadmium plating.

Not SFI Rated.



### D3

| CODE     | TYPE               | PRICE    |
|----------|--------------------|----------|
| 3B22PIKX | 2" BLACK WITH PADS | \$129.95 |
| 3B22PIRX | 2" RED WITH PADS   | \$129.95 |
| 3B22PIBX | 2" BLUE WITH PADS  | \$129.95 |
| 3B33PIKX | 3" BLACK WITH PADS | \$139.95 |
| 3B33PIRX | 3" RED WITH PADS   | \$139.95 |
| 3B33PIBX | 3" BLUE WITH PADS  | \$139.95 |
| 3B22NIKX | 2" BLACK NO PADS   | \$109.95 |
| 3B22NIRX | 2" RED NO PADS     | \$109.95 |
| 3B22NIBX | 2" BLUE NO PADS    | \$109.95 |
| 3B33NIKX | 3" BLACK NO PADS   | \$119.95 |
| 3B33NIRX | 3" RED NO PADS     | \$119.95 |
| 3B33NIBX | 3" BLUE NO PADS    | \$119.95 |

ALSO AVAILABLE IN STANDARD LATCH AND LINK  
CALL FOR PRICING

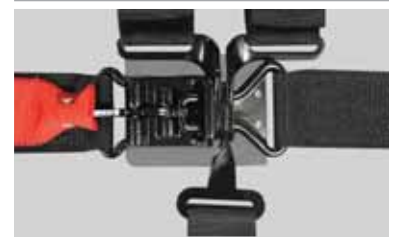

## NEW RZR FRONT DOOR BAG SET

Simpson door bags add storage, style and function in just minutes. Its tone-on-tone hexagonal-printed, all-weather-resistant fabric is durable but subtle enough not to clash with your vehicle's color scheme.

### FEATURES

- Reverse coil zippers protect contents from dust, dirt and moisture
- Reverse dust cover keeps dust and dirt from collection on zippers
- Expansive storage compartment with internal pockets
- Paneled construction allows for maximum storage
- Double-side coated fabric allows for easy cleaning inside and out
- Padded knee area
- (2) To Go Bags/Phone bags you can take with you

### COLOR

Black

CODE:  
**ORBGRZRF18K**

PRICE:  
**\$139.95**

FITS:  
2014 – 18 POLARIS RZR XP 1000/ALL TURBOS/XP 4 1000 TURBO 4 (FRONT DOORS ONLY)  
2015 – 18 RZR 900XC/S900/4 900 FRONT ONLY/RZR S4 900

**BAGS ONLY FIT OEM/STOCK DOORS**



TO GO BAGS



OPEN



CLOSED

## NEW UNIVERSAL CENTER CAB BAG

Our Universal Center Cab Bag will fit in most vehicles and can be easily removed and used as a small backpack. It's constructed using our durable tone-on-tone hexagonal-printed all-weather-resistant fabric.

### FEATURES

- Reverse coil zippers protect contents from dust, dirt and moisture
- Reverse dust cover keeps dust and dirt from collection on zippers
- Expansive storage compartment with internal pockets
- Paneled construction allows for maximum storage
- Double-side coated fabric allows for easy cleaning inside and out

CODE:  
**ORBESH18K**

PRICE:  
**\$59.95**

COLOR  
Black



THIS BAG IS DESIGNED TO BE EASILY REMOVED FROM YOUR VEHICLE AND USED AS A BACKPACK ONCE YOU HAVE ARRIVED AT YOUR DESTINATION.



## NEW CAN AM X3 DOOR BAG SET

Simpson door bags add storage, style and function in just minutes. Designed using a super-durable hexagonal-printed, tone-on-tone, double-side coated black fabric, these bags add style to your ride without clashing with your vehicle's color scheme.

### FEATURES

- Reverse coil zippers protect contents from dust, dirt and moisture
- Reverse dust cover keeps dust and dirt from collection on zippers
- Expansive storage compartment with internal pockets
- Paneled construction allows for maximum storage
- Double-side coated fabric allows for easy cleaning inside and out
- Padded knee protection
- (2) To Go Bags/Phone bags you can take with you

### COLOR

Black

CODE:  
**ORBGAFC18K**

PRICE:  
**\$139.95**

BAGS ONLY FIT OEM/STOCK DOORS



OPEN



CLOSED



TO GO BAGS



## SEAT MOUNTS



| CODE | TYPE  | PRICE   |
|------|---|---------|
| 115  | POLARIS RZR 570/800/900/1000/TURBO (INCLUDING FRONT OF ALL RZR 4), GENERAL, RS1 | \$19.95 |
| 115W | POLARIS RZR WIDE BODY & PRO SPORT MOUNT, FITS ALL ABOVE MODELS                  | \$19.95 |
| 116  | POLARIS RZR REAR SEAT MOUNT 800/900/1000/ALL TURBOS, GENERAL 4                  | \$19.95 |
| 116W | POLARIS RZR REAR PRO SPORT SEAT MOUNT 800/900/1000/ALL TURBOS, GENERAL 4        | \$19.95 |
| 110D | POLARIS 170 DRIVER MOUNT  | \$29.95 |
| 110P | POLARIS 170 PASSENGER MOUNT   | \$29.95 |

| CODE | TYPE   | PRICE    |
|------|--|----------|
| 303  | CAN AM X3 STANDARD FRONT MOUNT                       | \$49.95  |
| 303L | CAN AM X3 1" LOWER FRONT MOUNT                       | \$49.95  |
| 304L | CAN AM X3 REAR MOUNT (2" SHORTER BASE FRONT TO BACK) | \$49.95  |
| 202D | YAMAHA YXZ DRIVER MOUNT                              | \$59.95  |
| 202P | YAMAHA YXZ PASSENGER MOUNT                           | \$59.95  |
| 270D | WILD CAT XX DRIVER MOUNT                             | \$89.95  |
| 270P | WILD CAT XX PASSENGER MOUNT                          | \$139.95 |

OTHER MODELS ARE AVAILABLE. CALL 310-325-6035 x122

## YXZ DOOR LATCH PADS

| CODE  | TYPE   | PRICE   |
|-------|--------|---------|
| 2021K | BLACK  | \$49.95 |
| 2021G | GREY   | \$49.95 |
| 2021R | RED    | \$49.95 |
| 2021B | BLUE   | \$49.95 |
| 2021O | ORANGE | \$49.95 |

SOLD AS A PAIR

## YXZ LAP BELT MOUNTS

| CODE | TYPE                | PRICE   |
|------|---------------------|---------|
| 2022 | YXZ LAP BELT MOUNTS | \$39.95 |

## POLARIS LAP BELT MOUNTS

**POLARIS OWNERS – ARE YOUR LAP BELTS TWISTED?**

| CODE | TYPE                    | PRICE   |
|------|-------------------------|---------|
| 2030 | POLARIS LAP BELT MOUNTS | \$29.95 |

## SEAT OPTIONS

| CODE      | TYPE              | PRICE    |
|-----------|-------------------|----------|
| HEATER    | SEAT HEATER       | \$179.95 |
| LUMBAR    | ADJUSTABLE LUMBAR | \$159.95 |
| POCKETFRT | FRONT POCKET      | \$49.95  |
| POCKETRR  | REAR POCKET       | \$79.95  |

| CODE        | TYPE                            | PRICE   |
|-------------|---------------------------------|---------|
| POCKETHYDRO | HYDRATION PACK POCKET           | \$99.95 |
| EXTRAWIDE   | EXTRA WIDE                      | \$49.95 |
| HEADREST    | ADD HEADRESTS TO OFF-ROAD BENCH | \$99.95 |
| DIAMOND     | DIAMOND STITCH                  | \$49.95 |

## SEAT MEASUREMENTS

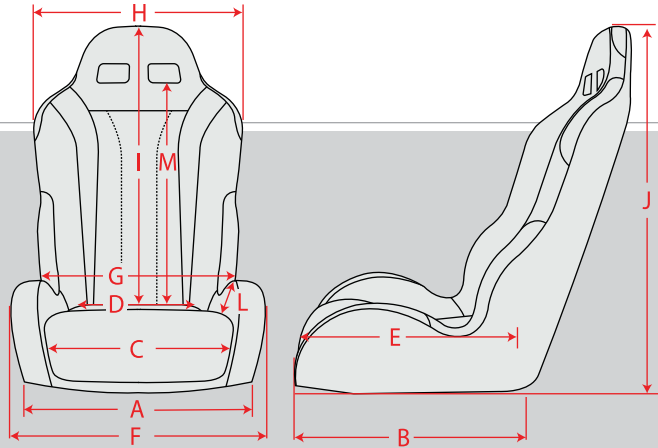

- A Base Width
- B Base Length
- C Cushion Width Front
- D Cushion Width Rear
- E Cushion Length
- F Overall Width Thigh
- G Overall Width Waist
- H Overall Width Shoulder
- I Back Height
- J Overall Height
- K Tabs/Rails
- L Bolster Height
- M Shoulder Slots

### VORTEX

|                          |           |
|--------------------------|-----------|
| A Base Width             | 17"       |
| B Base Length            | 21"       |
| C Cushion Width Front    | 15"       |
| D Cushion Width Rear     | 11"       |
| E Cushion Length         | 20"       |
| F Overall Width Thigh    | 20"       |
| G Overall Width Waist    | 20"       |
| H Overall Width Shoulder | 21"       |
| I Back Height            | 29"       |
| J Overall Height         | 32.5"     |
| K Tabs                   | Universal |
| L Bolster Height         | 4"        |
| M Shoulder Slots         | 24"       |

Weight 23lb  
Angle 75

### WIDE BODY

|                          |           |
|--------------------------|-----------|
| A Base Width             | 18.5"     |
| B Base Length            | 22"       |
| C Cushion Width Front    | 17"       |
| D Cushion Width Rear     | 11"       |
| E Cushion Length         | 20.5"     |
| F Overall Width Thigh    | 22"       |
| G Overall Width Waist    | 20"       |
| H Overall Width Shoulder | 23"       |
| I Back Height            | 29"       |
| J Overall Height         | 32.5"     |
| K Tabs                   | Universal |
| L Bolster Height         | 2"        |
| M Shoulder Slots         | 24"       |

Weight 24lb  
Angle 75

### REAR

|                          |           |
|--------------------------|-----------|
| A Base Width             | 17"       |
| B Base Length            | 19"       |
| C Cushion Width Front    | 15"       |
| D Cushion Width Rear     | 11"       |
| E Cushion Length         | 17"       |
| F Overall Width Thigh    | 20"       |
| G Overall Width Waist    | 20"       |
| H Overall Width Shoulder | 21.5"     |
| I Back Height            | 29"       |
| J Overall Height         | 32.5"     |
| K Tabs                   | Universal |
| L Bolster Height         | 4"        |
| M Shoulder Slots         | 24"       |

Weight 19.5lb  
Angle 75

### BENCH

|                          |         |
|--------------------------|---------|
| A Base Width             | 43.5"   |
| B Base Length            | 19"     |
| C Cushion Width Front    | 38.5"   |
| D Cushion Width Rear     | 37"     |
| E Cushion Length         | 18"     |
| F Overall Width Thigh    | 44.75"  |
| G Overall Width Waist    | 44"     |
| H Overall Width Shoulder | 45.5"   |
| I Back Height            | 29"     |
| J Overall Height         | 34.25"  |
| K Tabs                   | 10.875" |
| L Bolster Height         | 4.5"    |
| M Shoulder Slots         | 23"     |

Weight 48lb  
Angle 75

### PRO SPORT

|                          |           |
|--------------------------|-----------|
| A Base Width             | 19.5"     |
| B Base Length            | 22"       |
| C Cushion Width Front    | 17"       |
| D Cushion Width Rear     | 11"       |
| E Cushion Length         | 20.5"     |
| F Overall Width Thigh    | 23"       |
| G Overall Width Waist    | 20"       |
| H Overall Width Shoulder | 23"       |
| I Back Height            | 32.5"     |
| J Overall Height         | 34"       |
| K Tabs                   | Universal |
| L Bolster Height         | 3"        |
| M Shoulder Slots         | 23"       |

Weight 24lb  
Angle 75

### 170 AGGRESSOR

|                          |           |
|--------------------------|-----------|
| A Base Width             | 16"       |
| B Base Length            | 17.5"     |
| C Cushion Width Front    | 12.5"     |
| D Cushion Width Rear     | 10"       |
| E Cushion Length         | 15"       |
| F Overall Width Thigh    | 17.5"     |
| G Overall Width Waist    | 15.5"     |
| H Overall Width Shoulder | 19.5"     |
| I Back Height            | 24"       |
| J Overall Height         | 26"       |
| K Tabs                   | Universal |
| L Bolster Height         | 2.5"      |
| M Shoulder Slots         | 17.5"     |

Weight 16lb  
Angle 73

### TSR

|                          |           |
|--------------------------|-----------|
| A Base Width             | 15.5"     |
| B Base Length            | 21.5"     |
| C Cushion Width Front    | 15"       |
| D Cushion Width Rear     | 11"       |
| E Cushion Length         | 21"       |
| F Overall Width Thigh    | 22.5"     |
| G Overall Width Waist    | 22.25"    |
| H Overall Width Shoulder | 25"       |
| I Back Height            | 31"       |
| J Overall Height         | 34.5"     |
| K Tabs                   | 14" x 18" |
| L Bolster Height         | 5.25"     |
| M Shoulder Slots         | 24"       |

Weight 27lb  
Angle 75

### PRO V2

|                          |           |
|--------------------------|-----------|
| A Base Width             | 15.5"     |
| B Base Length            | 21.5"     |
| C Cushion Width Front    | 14.5"     |
| D Cushion Width Rear     | 11.5"     |
| E Cushion Length         | 21"       |
| F Overall Width Thigh    | 20.75"    |
| G Overall Width Waist    | 21.75"    |
| H Overall Width Shoulder | 23"       |
| I Back Height            | 30"       |
| J Overall Height         | 34"       |
| K Tabs                   | 14" x 18" |
| L Bolster Height         | 8.5"      |
| M Shoulder Slots         | 23"       |

Weight 22lb  
Angle 75

### XL-R

|                          |           |
|--------------------------|-----------|
| A Base Width             | 19"       |
| B Base Length            | 22"       |
| C Cushion Width Front    | 14"       |
| D Cushion Width Rear     | 11.5"     |
| E Cushion Length         | 19"       |
| F Overall Width Thigh    | 21.25"    |
| G Overall Width Waist    | 19.75"    |
| H Overall Width Shoulder | 21.5"     |
| I Back Height            | 29.5"     |
| J Overall Height         | 34"       |
| K Tabs                   | 14" x 18" |
| L Bolster Height         | 2"        |
| M Shoulder Slots         | 23"       |

Weight 28lb  
Angle Adjustable

### REVOLVER

|                          |        |
|--------------------------|--------|
| A Base Width             | 18.25" |
| B Base Length            | 20.5"  |
| C Cushion Width Front    | 15"    |
| D Cushion Width Rear     | 13"    |
| E Cushion Length         | 19"    |
| F Overall Width Thigh    | 22"    |
| G Overall Width Waist    | 21.5"  |
| H Overall Width Shoulder | 22"    |
| I Back Height            | 28"    |
| J Overall Height         | 32.5"  |
| K Rails                  | 9"     |
| L Bolster Height         | 3"     |
| M Shoulder Slots         | 21"    |

Weight 21lb  
Angle 73

### APEX

|                          |           |
|--------------------------|-----------|
| A Base Width             | 16"       |
| B Base Length            | 22"       |
| C Cushion Width Front    | 13"       |
| D Cushion Width Rear     | 10.5"     |
| E Cushion Length         | 19"       |
| F Overall Width Thigh    | 21.5"     |
| G Overall Width Waist    | 22"       |
| H Overall Width Shoulder | 21.5"     |
| I Back Height            | 29"       |
| J Overall Height         | 31.75"    |
| K Tabs                   | 14" x 18" |
| L Bolster Height         | 5"        |
| M Shoulder Slots         | 21"       |

Weight 17lb  
Angle 77

# PUT ON THE ADVANTAGE

RACING SUITS

## ORDER INFORMATION

### ORDER TOLL-FREE

1-800-654-7223 + Fax: 1-830-625-3269

Our sales team is ready to take your order or provide any assistance you may require by toll-free phone, mail or fax.

### CUSTOM SUITS & CREW UNIFORMS

1-888-872-SUIT (7848) + FAX: 1-310-320-7179

If you need assistance or help in ordering custom suits and/or crew uniforms, call our Tech Information and Help Line first. They will explain the different styles of suits, options, sizing, embroidery and anything else you might need to know.

### TECHNICAL SUPPORT & HELP LINE

1-800-654-RACE (7223) or 1-888-872-SUIT (7848)

(Custom Suits & Crew Uniforms) If you have a question about a product or would like to check on an order, please call our toll-free Technical Support line between 8 AM – 5 PM, Monday through Friday, Central Time. Or, use the toll-free 1-888-872-SUIT (7848) between 8 AM – 5 PM, Monday through Friday, Pacific Time for assistance regarding Custom Suits and Crew Uniforms.

### RETURNS

Simpson warrants all products to be free from all defects in material and workmanship when used according to the manufacturer's instructions. Warranty does not include damage to the product as a result of misuse, abuse of the product, or normal wear and tear. Simpson will provide a replacement part or product at its sole discretion. Purchaser must assume responsibility for the cost of shipping the product to Simpson for service or inspection. Should any product not meet your expectations for fit, workmanship and quality, please call 1-800-654-7223.

### PRODUCT SERVICES & RETURNS

If for any reason you would like to return a product you purchased, or have a product you need serviced or inspected, ship it to Simpson via insured Parcel Post or UPS within 30 days. Please return new products in original condition, in the same boxes with a copy of the invoice to:

**Simpson Performance Products**  
328 FM 306, New Braunfels, TX 78130

### CUSTOM SUIT RETURNS

If you need to return a Custom Crew Suit or Crew Uniform for alterations, please send to the following address:

**Simpson Performance Products**  
1407 West 240th Street, Harbor City, CA 90710



JOEY COULTER, STOCK CAR DRIVER

## SIMPSON FINANCING FOR RACERS

### SEE PAGE 5 FOR APPLICATION

Racing can be a dangerous sport, and safety products often fall by the way when purchases for the car and entry fees are more critical. Simpson offers a finance program that helps to make safe racing affordable.

Purchases of \$500 and greater qualify for our generous interest free, 90-day, 3-payment finance program. A new Snell 2015 helmet, the head restraint you know you need and the latest in racing suit technology can all be yours. It is easy to apply and we can often approve you the same day. Turn to page 5 for our simple application. Our safety experts are happy to walk you through the process and get your safety gear on the way to you before your next race.

Call us at 1-800-654-7223.

## NOMEX® TECHNOLOGY RACE PROTECTION

DuPont™  
Nomex.

### PERFORMANCE & CONFIDENCE

Racing professionals can't have one without the other. That's why they wear racing suits made of DuPont™ Nomex® fiber. In fact, 95% of racers around the world trust the protection of Nomex® to keep them safe. It manages extreme heat, yet still delivers incredible comfort, style and durability – giving them the performance only Nomex® thermal technology can provide. Racing suits and apparel made of Nomex® fiber help play a pivotal role in providing the valuable seconds racing professionals need to escape fires that result from both on-track collisions and pit accidents.

### BUILT IN

Racing gear made of Nomex® is inherently flame resistant; the FR (flame resistant) protection is built into the fiber and cannot be washed out or worn away – ever. It won't melt or combust when exposed to flame and actually becomes thicker when exposed to intense heat forming a protective barrier between the heat source and the skin.

### TRUST

For more than 30 years, DuPont™ Nomex® has been the industry leader around the world in FR protection against the ever-present danger of fires at the racetrack.

95% of racers (NASCAR®, IRL, NHRA, WoO and IHRA) around the world, including their pit crews, rescue teams and track officials, trust and depend on the FR protection of racing suits made with DuPont™ Nomex®.

## SUIT TESTING

**THERMO-MAN®** is the most advanced life-sized thermal burn injury evaluation system in the world today. He can be exposed to various fire hazards through controlled burns to test burn protection properties of garment constructions, fabric weights, material types and garment design styles. Results predict the amount, degree and location of burn injuries that would be sustained by the wearer in a flash fire.

DuPont scientists use this information to help apparel manufacturers develop optimum designs in lightweight, flame-resistant suits that equip drivers, pit crews, rescue teams and track officials with garments that are comfortable and provide the best thermal protection possible.

### LEARN MORE AT DUPONT.COM/NOMEX

DuPont™ Nomex® is a trademark of E.I. du Pont de Nemours and Company

## FABRIC COLOR RANGE

DuPont™  
**Nomex**

| COLORS  | WHITE | BLACK | NAVY BLUE | ROYAL BLUE | PACIFIC BLUE | PEWTER | YELLOW | GOLDEN YELLOW | GOLD | GREEN | LIME GREEN | PURPLE | PINK | RED | ORANGE |
|---|-------|-------|-----------|------------|--------------|--------|--------|---------------|------|-------|------------|--------|------|-----|--------|
| <b>TITANIUM NOMEX®</b><br>Our lightest weight fabric. High luster finish. Excellent choice for custom design incorporating embroidery and trim.                             | •     | •     | •         | •          | •            | •      | •      | •             | •    | •     | N/A        | •      | N/A  | •   | •      |
| <b>SIGNATURE KNIT NOMEX®</b><br>A lightweight comfortable fabric with excellent breathability. It offers superior fire protection, and a subtle stretch for added mobility. | •     | •     | •         | •          | N/A          | N/A    | •      | N/A           | N/A  | •     | N/A        | N/A    | N/A  | •   | •      |
| <b>SATIN/TWILL</b><br>Semishiny woven fabric with a relaxed, soft and supple feel, available in a wide variety of colors.   | •     | •     | •         | •          | N/A          | •      | •      | •             | N/A  | •     | •          | •      | •    | •   | •      |

- = Available N/A = Not Available
- Titanium Nomex® also available in Busch Blue.
- Satin/Twill also available in Maroon and Brown.

## CUSTOM SUIT DESIGN OPTIONS TRIM CHARGES SHOWN ARE IN ADDITION TO THE BASE SUIT PRICE.

Custom suit design options, choose your colors from our wide selection. Visit our free online suit design tool at [simpsonperformance.com](http://simpsonperformance.com) and make your vision a reality.



## CUSTOM MADE-TO-ORDER RACING SUITS



Our Made-To-Order custom racing suits are made to order per your exact specifications at our factory in the USA. They are SFI approved and feature genuine DuPont™ Nomex® fabric. Our suits provide protection and comfort from over 14 measurements that are uniquely yours for a true custom fit. Our custom racing suits are offered in single layer, 2-layer and 3-layer suits as well as drag racing suits. Try our lumbar stretch panels for added comfort and ease of movement. Our large selection of color choices allows for compatibility with sponsor requirements.

### EACH MTO SUIT INCLUDES

- Custom fit with 14 different measurements
- Vertical quilt
- Choice of collar (banded, soft knit, wraparound)
- Zippered breast pocket on select styles
- Epaulets with Simpson logos included
- Name embroidered on front belt
- Inset front pockets
- Colored rib cuffs (Red, White, Blue or Black)
- SFI tags included where mandated

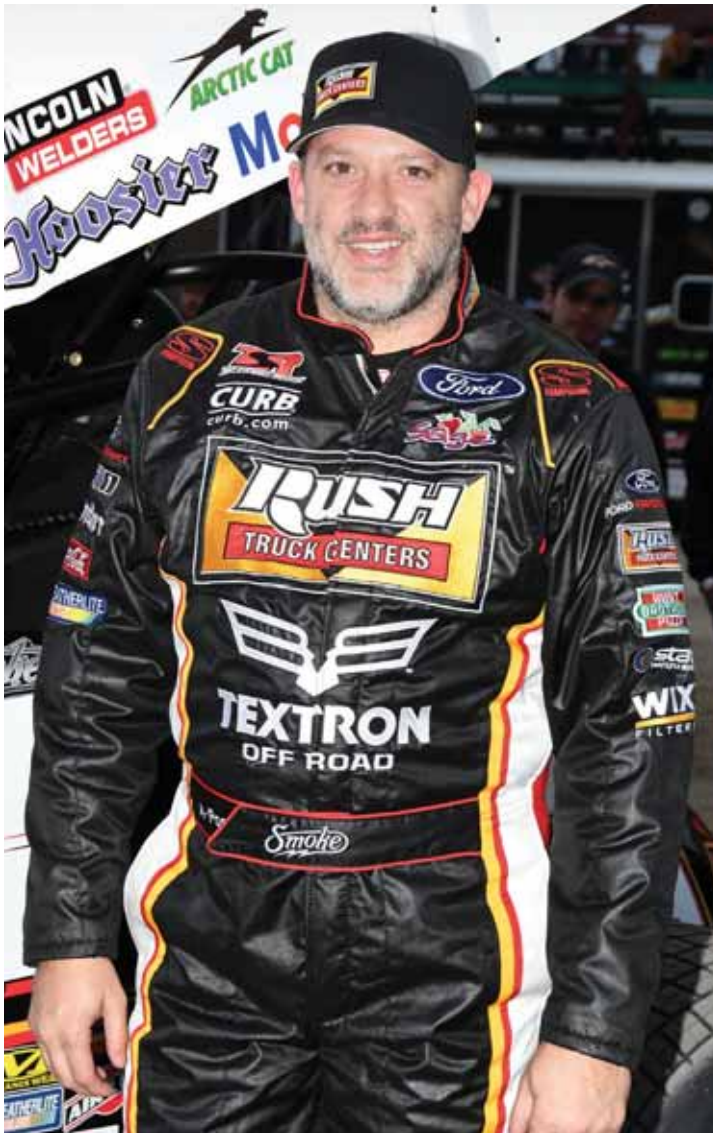

### Available Features

The suits pictured in our custom suit section are here to show you the multitude of style and material options that are available. When you see the Custom logo next to a racing suit, the product is available in custom colors and features. You are not limited by any of these designs in any particular suit style. Design your own suit with the available features below. However, if you like a particular design that you see, call 888-872-SUIT (7848), and our customer service staff will assist you. Or design online at [simpsonperformance.com](http://simpsonperformance.com).

| ADD ON FEATURES  | PRICE          |
|--|----------------|
| 360° FULL ARM GUSSETS  | \$99.00        |
| LOWER BACK EXPANDABLE GUSSET                                       | \$99.00        |
| BOX QUILT MATCHED TO SUIT UNLESS CONTRASTING THREADS ARE REQUESTED | \$89.00        |
| REAR PATCH POCKET  | \$29.00        |
| STRAIGHT LEG CUFF  | \$59.00        |
| BUILT-IN ARM RESTRAINTS  | \$69.00        |
| TWO PIECE SEPARATES, JACKET AND PANT                               | \$49.00        |
| HOOF OPTION, STRAIGHT LEG CUFF REQUIRED                            | \$49.00        |
| CUSTOM DESIGN AND EMBROIDERY AVAILABLE                             | CALL FOR QUOTE |

### RACER DELUXE PACKAGE: BEST VALUE! ONLY \$199.00

INCLUDES 360 DEGREE ARM GUSSETS, LOWER BACK GUSSET. STRAIGHT LEG CUFF AND BOX OR VERTICAL QUILT, \$346.00 IF PURCHASED SEPARATELY



TONY STEWART "SMOKE",  
TONY STEWART RACING,  
IMAGE COURTESY OF FRANK'S PHOTOS

## CUSTOM DNA

SIMPSON SUIT FEATURING  
**NOMEX**

**SFI 3.2A/5**

MADE IN U.S.A.

The DNA suit combines industry-changing innovations and advanced design in a suit that offers almost no restrictions to movement, unbeatable breathability and incredibly lightweight fabric. This game-changing suit is constructed to meet the needs of our athletes on the track and loaded with features available only at Simpson.

CODE:  
**MT0.26**

BASE PRICE:  
**\$1,829.00**

**COLORS**  
See page 54

### THE PACKAGE INCLUDES

SFI.5 approved Titanium Nomex® racing suit, Made in the USA

Integrated cuffs replace traditional sleeve cuffs, minimizing material at your wrist and eliminating bunching in the glove gauntlet area

X-Tech stretch elbows allow for effortless movement of the arms, helping with fatigue and stopping the sleeve from migrating up the arm

X-Tech stretch body panels reduce tension across the back, torso, waist, hips and thighs

Stretch panels offer improved ventilation in key areas of the body

Stylish outside pockets lay flat to eliminate bunching and require less material

Embroidered trim adds style without adding unwanted weight



DONNY SCHATZ,  
TONY STEWART RACING,  
IMAGE COURTESY OF FRANK'S PHOTOS



## DRIVER'S PERFORMANCE PACKAGE

### AMP UP YOUR CUSTOM SUIT!

Simpson's Driver Performance Package may be added to any custom suit.

CODE:  
**PERFPKG**

BASE PRICE:  
**\$249.00**

### THE PACKAGE INCLUDES

- Fast back epaulets
- Flying V quilting adds bold styling
- Elbow stretch panels reduce arm fatigue
- Front only half belt is non-binding
- Neck, sides and lower back X-Tech stretch ventilation reduces binding and improves breathability
- Innovative above the knee and crotch gussets reduce thigh and knee stress
- Tapered leg minimizes excess material and reduces weight



JOSH BERRY,  
JR MOTORSPORTS,  
IMAGE COURTESY OF JR MOTORSPORTS

## PRO LITE CUSTOM DRAG SUITS



Less is more with our newest SFI 15 drag racing suit, the Pro Lite. Experience exceptional breathability and lightweight comfort without sacrificing protection. Custom in every way, our suits move with the racer allowing maximum comfort behind the wheel. Our exclusive materials provide strategic stretch without bulkiness, for a sleek presentation. Simpson is the official safety partner to John Force Racing, providing top quality gear for NHRA Funny Car champions John Force and Robert Hight and all of the JFR athletes. Shop our line of SFI 15 and SFI 20 suits here.

### FEATURES

2-Piece Drag Suits add \$50

Suit shown in Signature Knit Nomex fabric with custom trim designs.

Call for quote.

All SFI.15 and SFI.20 suits feature our standard vertical quilting; box quilting available upon request  
Arm restraints, full arm gusset



| sfi 3.2A/20                     |                               |            |
|---------------------------------|-------------------------------|------------|
| CODE                            | FABRIC                        | PRICE      |
| MD.50W                          | NEW PRO LITE NOMEX® / 1-PIECE | \$2,549.00 |
| COLORS: Black, Blue, Red, White |                               |            |

| sfi 3.2A/20   |                                 |            |
|---|---------------------------------|------------|
| CODE  | FABRIC                          | PRICE      |
| MD.50T  | SIGNATURE KNIT NOMEX® / 1-PIECE | \$1,949.00 |
| COLORS: Royal Blue, White, Black, Navy, Red, Orange, Green, Yellow  |                                 |            |
| MD.50KS   | SATIN/TWILL 1-PIECE             | \$1,849.00 |
| COLORS: Royal Blue, White, Black, Navy, Red, Silver, Orange, Green, Purple, Yellow, Golden Yellow, Lime Green, Pink |                                 |            |

| sfi 3.2A/15   |                                 |            |
|---|---------------------------------|------------|
| CODE  | FABRIC                          | PRICE      |
| MD.40T  | SIGNATURE KNIT NOMEX® / 1-PIECE | \$1,749.00 |
| COLORS: Royal Blue, White, Black, Navy, Red, Orange, Green, Yellow  |                                 |            |
| MD.40KS   | SATIN/TWILL 1-PIECE             | \$1,649.00 |
| COLORS: Royal Blue, White, Black, Navy, Red, Silver, Orange, Green, Purple, Yellow, Golden Yellow, Lime Green, Pink |                                 |            |



ROBERT HIGHT,  
NHRA FUNNY CAR DRIVER,  
JOHN FORCE RACING

## CUSTOM SFI.1 AND SFI.5 RACING SUITS

SIMPSON SUIT FEATURING  
**NOMEX**    
CUSTOM MADE IN U.S.A.

**sfi 3.2A/1**

| CODE   | FABRIC                 | PRICE    |
|--|------------------------|----------|
| MT0.6  | SATIN/TWILL CUSTOM FIT | \$929.00 |
| <i>COLORS:</i> Royal Blue, White, Black, Navy, Red, Silver, Orange, Green, Purple, Yellow, Golden Yellow, Lime Green, Pink |                        |          |

**sfi 3.2A/5**

| CODE   | FABRIC                                      | PRICE      |
|--|---|------------|
| MT0.26   | TITANIUM NOMEX®/CUSTOM DNA                  | \$1,829.00 |
| <i>COLORS:</i> Royal Blue, White, Black, Red, Yellow, Golden Yellow, Silver, Gold, Navy, Pacific Blue                      |   |            |
| MT0.24   | TITANIUM NOMEX® / CUSTOM FIT                | \$1,429.00 |
| <i>COLORS:</i> Royal Blue, White, Black, Red, Yellow, Golden Yellow, Silver, Gold, Navy, Pacific Blue                      |   |            |
| MT0.25   | SIGNATURE KNIT NOMEX® / CUSTOM FIT          | \$1,329.00 |
| <i>COLORS:</i> Royal Blue, White, Black, Navy, Red, Orange, Green, Yellow  |   |            |
| MT0.21   | SATIN/TWILL CUSTOM FIT WITH KNIT RIB LINING | \$1,129.00 |
| <i>COLORS:</i> Royal Blue, White, Black, Navy, Red, Silver, Orange, Green, Purple, Yellow, Golden Yellow, Lime Green, Pink |   |            |

**sfi 3.2A/5**

|  |                                    |            |
|--|------------------------------------|------------|
| MT0.33   | SIGNATURE KNIT NOMEX® / CUSTOM FIT | \$1,439.00 |
| <i>COLORS:</i> Royal Blue, White, Black, Navy, Red, Orange, Green, Yellow  |                                    |            |
| MT0.33   | SATIN/TWILL CUSTOM FIT             | \$1,239.00 |
| <i>COLORS:</i> Royal Blue, White, Black, Navy, Red, Silver, Orange, Green, Purple, Yellow, Golden Yellow, Lime Green, Pink |                                    |            |



JUSTIN ALGAIER,  
JR MOTORSPORTS



## LIGHTWEIGHT AND NON-RATED FULLY SUBLIMATED CUSTOM SUIT



### IDEAL FOR KARTING OR PHOTOGRAPHY

Simpson's Non-FR Suits offer the professional look you want both on and off the track. By sublimating directly onto the fabric, we can offer a lightweight suit with endless color and design options. Sublimation reduces your cost by eliminating intricate embroidery. It is a vivid color process that will look as good at the end of the season as it did when you removed it from the box. Unlimited sponsor logos and lettering. Suit features: custom fit and tailored measurements, vertical quilt, choice of collar (banded, soft knit, wraparound), zippered breast patch pocket (not available for styles C/D/F/I/K/L), epaulets, name embroidery (standard type face on belt: Script), inset front pockets, and colored rib cuffs (Red, White, Blue, Black). Customer to supply vector artwork.



### Sublimated Kart Suit, 1 Piece

| CODE                    | SIZE       | PRICE    |
|-------------------------|------------|----------|
| MK.TS                   | CUSTOM FIT | \$549.00 |
| FABRIC: 600 DENIER POLY |            |          |

### Sublimated Kart Jacket

| CODE                    | SIZE       | PRICE    |
|-------------------------|------------|----------|
| MT.KSJ                  | CUSTOM FIT | \$299.00 |
| FABRIC: 600 DENIER POLY |            |          |

### Suit Options Available. Additional charges apply:

| FEATURES   | PRICE              |
|--|--------------------|
| 360° FULL ARM SHOULDER GUSSET  | \$99.00            |
| LOWER BACK EXPANDABLE GUSSET   | \$99.00            |
| BOX QUILT (MATCHES SUIT COLOR: CONTRAST THREAD AVAILABLE)  | \$89.00            |
| STRAIGHT LEG CUFF  | \$59.00            |
| 2-PIECE DRIVING SUIT (SEPARATE JACKET & PANT)  | \$49.00            |
| RACER'S DELUXE PACKAGE:<br>360° arm gussets, lower back gussets, straight leg cuff and full box quilt. | \$199.00           |
| EMBROIDERY (CUSTOM LOGOS & GRAPHICS)   | SEND ART FOR QUOTE |



## NEW SIX 0 RACING SUIT



Celebrating our 60 years in the racing firesuit business, we proudly introduce the Six 0 premium racing suit, our newest lightweight two-layer SFI-5 suit that offers flexibility and functionality all in one! An attractive contemporary trim design sets this suit apart from the ordinary.

The Satin outer layer has a slight sheen combined with a soft knit inner layer. The Six 0 offers excellent breathability without sacrificing fire protection. Well-placed stretch panels move with the racer both in and out of the car, offering superior memory for a great fit.

### FEATURES

- SFI.5 Rated
- Satin knit fabric with stylish non-contrasting V-quilting
- Adjustable ultra-soft knit collar and half-belt for a streamlined fit
- X-Tech body stretch panels in the side, back, thighs and knees that offer improved ventilation
- Straight leg cuffs
- 360° full arm gusset allowing full floating sleeves and unrestricted movement
- Four colorway options

CODE:  
**STD.13**

SIZE:  
**S-XXL**

PRICE:  
**\$999.00**

### COLORS

Black/Grey, Black/Blue, Black/Red, Blue/Red

15% UPCHARGE FOR XXL



FREDRIC AASBO,  
FORMULA DRIFT DRIVER,  
PAPADAKIS RACING



## DNA SFI 5 RACING SUIT



|                     |                             |                             |
|---------------------|-----------------------------|-----------------------------|
| CODE:<br><b>DNA</b> | SIZE:<br><b>S, M, L, XL</b> | PRICE:<br><b>\$1,349.00</b> |
|---------------------|-----------------------------|-----------------------------|

Become One Step Ahead of Your Competition With Today's Most Advanced Racing Suit customized in your team and sponsor colors and logos. See page 56 for custom DNA.

Our Popular DNA suit combines industry-changing innovations and advanced design in a suit that offers almost no restrictions to movement, unbeatable breathability and incredibly lightweight fabric. This game-changing suit is constructed to meet the needs of our athletes on the track and loaded with features available only at Simpson. The DNA suit combines industry-changing innovations and advanced design in a suit that offers almost no restrictions to movement, unbeatable breathability and incredibly lightweight fabric.

### FEATURES

- SFI.5 approved Titanium Nomex racing suit, Made in the USA
- Integrated cuffs replace traditional sleeve cuffs, minimizing material at your wrist and eliminating bunching in the glove gauntlet area
- X-Tech stretch elbows allow for effortless movement of the arms, helping with fatigue and stopping the sleeve from migrating up the arm
- X-Tech stretch body panels reduce tension across the back, torso, waist, hips and thighs
- Stretch panels offer improved ventilation in key area of the body
- Stylish outside pockets lay flat to eliminate bunching and require less material
- Embroidered trim adds style without adding unwanted weight

### COLORS

Red/White, Blue/White, Black/White

### SUIT FABRIC

Titanium Nomex®



### INTEGRATED CUFFS

replace traditional sleeve cuffs, minimizing material at your wrist and eliminating bunching in the glove gauntlet area



### X-TECH STRETCH ELBOWS

allow for effortless movement of the arms, helping with fatigue and stopping the sleeve from migrating up the arm

### RACING SUIT SIZE CHART

| SIZE   | CHEST | WAIST | HIP   | INSEAM | NECK | HEIGHT        | WEIGHT     |
|--------|-------|-------|-------|--------|------|---------------|------------|
| SMALL  | 30-34 | 26-30 | 33-37 | 31     | 14.5 | 5'5" TO 5'7"  | 115 TO 130 |
| MEDIUM | 34-38 | 30-34 | 37-41 | 32     | 15.5 | 5'7" TO 5'10" | 140 TO 165 |
| LARGE  | 38-42 | 34-38 | 41-45 | 33     | 16.5 | 5'10" TO 6'2" | 175-200    |
| XL     | 42-46 | 38-42 | 45-49 | 34     | 17.5 | 5'11" & OVER  | 210-225    |
| XXL    | 46-50 | 42-46 | 49-53 | 35     | 18.5 | 5'11" & OVER  | 235 TO 250 |

### YOUTH RACING SUIT SIZE CHART

| SIZE   | CHEST | WAIST | HIP   | INSEAM | NECK | HEIGHT        | WEIGHT     |
|--------|-------|-------|-------|--------|------|---------------|------------|
| XS     | 28-31 | 21-24 | 26-29 | 22     | 11   | 4'0" TO 4'4"  | 50 TO 60   |
| SMALL  | 31-33 | 24-26 | 29-31 | 23     | 12   | 4'1" TO 4'5"  | 60 TO 75   |
| MEDIUM | 33-36 | 26-28 | 31-33 | 24     | 13   | 4'5" TO 4'10" | 75 TO 90   |
| LARGE  | 36-38 | 29-31 | 34-36 | 26     | 13   | 5'0" TO 5'4"  | 90 TO 105  |
| XXL    | 39-41 | 32-34 | 38-40 | 28     | 14   | 5'4" TO 5'6"  | 105 TO 120 |



## NEW SPORTSMAN ELITE III RACING SUIT



Updated styling for the Sportsman Elite III features top and bottom full contrast. The Sportsman Elite suits are a great value with stylish and functional features including straight leg cuffs, 360° arm gussets and 3-point epaulets.

### FEATURES

SFI.5 Rated  
Patch style pockets  
Contrasting color style  
Available in one-piece design or as separate jacket and pants

### COLORS

Black/Grey, Red/Grey, Blue/Grey

### Sportsman Elite III

| CODE   | SIZE: S-XXL   | PRICE    |
|--------|---|----------|
| STD.16 | 1-PIECE<br>15% UPCHARGE FOR XXL                             | \$599.00 |
| STD.16 | JACKET<br>15% UPCHARGE FOR XXL                              | \$399.00 |
| STD.16 | JACKET WITH BUILT-IN ARM RESTRAINTS<br>15% UPCHARGE FOR XXL | \$449.00 |
| STD.5  | PANT<br>15% UPCHARGE FOR XXL                                | \$249.00 |

## SPORTSMAN ELITE II RACING SUIT



The Sportsman Elite II suits come with many of the same features as our MTO suits at half the price. Contrasting Platinum chest band and extensive white piping, banded collar, 360° arm gusset, 3-point epaulets, patch style pockets, straight leg cuffs, colored rib cuffs and vertical quilting.

### Sportsman Elite II

| CODE   | SIZE: S-XXL  | PRICE    |
|--------|--|----------|
| STD.15 | 1-PIECE<br>15% UPCHARGE FOR XXL                            | \$499.00 |
| STD.15 | JACKET<br>15% UPCHARGE FOR XXL                             | \$369.00 |
| STD.15 | JACKET WITH BUILT-IN ARM RESTRAINT<br>15% UPCHARGE FOR XXL | \$409.00 |
| STD.15 | PANT<br>15% UPCHARGE FOR XXL                               | \$239.00 |



### COLORS

Black, Red, Royal Blue

### FABRIC

Satin/Twill with fleece lining

## QUALIFIER RACING SUIT

The Qualifier SFI 3.2/5 Race suit is two-layer construction, lightweight and extremely breathable, and features our softest rib knit lining. The Qualifier has pre-curved floating sleeves and straight-leg cuffs with a two-tone modern design.

### FEATURES

Satin Twill with soft rib knit lining  
Straight cut leg  
360° Full arm gusset  
Ultra-soft knit cuffs  
SFI 3.2A/5 certified

### COLORS

Black/Grey, Blue/Grey, Red/Grey

### FABRIC

Satin/Twill



### Q1 QUALIFIER RACING SUIT

| CODE   | SIZE: S-XXL                     | PRICE    |
|--------|---------------------------------|----------|
| STD Q1 | 1-PIECE<br>15% UPCHARGE FOR XXL | \$829.95 |
| STD Q1 | PANT<br>15% UPCHARGE FOR XXL    | \$399.95 |
| STD Q1 | JACKET<br>15% UPCHARGE FOR XXL  | \$469.95 |



## HELIX RACING SUIT



The Helix driving suit belongs to our DNA strand of high-performance racing products. Simpson's DNA products are designed with athletic performance-enhancing features engineered to reduce weight and driver restrictions. Available in Adult and Youth Sizing.

CODE: **HX**      SIZE: **ADULT S - XXL**      PRICE: **\$699.00**

CODE: **HX-Y**      SIZE: **YOUTH XS - XL**      PRICE: **\$399.00**

See page 71 for Youth Helix.

### FEATURES

SFI.5 Rated  
270° arm and back gussets  
Knee and inner thigh stretch panels  
Lower back stress relief panel  
Upper back ventilation port  
No bulk, weight-saving patch pockets and embroidered trim and logo

### COLORS

Black, Red







## SUPER SPORT RACING SUIT



Satin/Twill suit with vertical quilting and fleece inner lining of 100% Nomex®. Featuring inset pant pockets, straight leg cuffs. Available in both 1-piece and 2-piece design.

**COLORS**

Black, Red, Royal Blue

**FABRIC**

Satin/Twill with fleece lining



### Super Sport

| CODE   | SIZE: S-XXL                                    | PRICE    |
|--------|--|----------|
| STD.SS | 1-PIECE<br>15% UPCHARGE FOR XXL                | \$429.00 |
| STD.SS | PANT<br>15% UPCHARGE FOR XXL                   | \$249.00 |
| STD.SS | JACKET<br>15% UPCHARGE FOR XXL                 | \$259.00 |
| STD.SS | JACKET WITH RESTRAINTS<br>15% UPCHARGE FOR XXL | \$299.00 |

## SFI-5 CLASSIC RACING SUIT



Our SFI-5 suit features woven Satin/Twill fabric with vertical quilting and zippered patch style breast pocket, straight leg cuff available.

**COLORS**

Black, Red, Royal Blue

**FABRIC**

Satin/Twill with fleece lining



### SFI-5 Classic

| CODE      | SIZE: S-XXL   | PRICE    |
|-----------|---|----------|
| 04 STD.19 | 1-PIECE<br>15% UPCHARGE FOR XXL<br>+ \$40 FOR STRAIGHT-LEG CUFF | \$479.00 |
| 04 STD.19 | JACKET<br>15% UPCHARGE FOR XXL                                  | \$289.00 |
| 04 STD.19 | JACKET WITH BUILT-IN ARM RESTRAINTS<br>15% UPCHARGE FOR XXL     | \$319.00 |
| 04 STD.19 | PANT<br>15% UPCHARGE FOR XXL<br>+ \$40 FOR STRAIGHT-LEG CUFF    | \$239.00 |

## VIXEN II FEMALE RACING SUIT

We love the Vixen II redesign that offers SFI 3.2/5 protection in a comfortable and stylish suit designed to accentuate curves and move with the racer. We began with the finest fabric interior and Shiny Twill outer layer. The Vixen II provides maximum protection from burn situations while at the same time delivering style and attention to detail. The design curves smoothly along the body shape with strategic darts, providing less bulk and a sleek silhouette. The front pockets lay flat and special attention has been given to the bust, waist and hip area, offering a proportion that is both desirable and wearable to our female racers.

### COLORS

Ebony Black with White Trim

Ebony Black with Pink Trim

Call for additional color options

### FABRIC

Satin/Twill Satin Twill outer with soft knit ribbed interior



CODE:  
STD.18

SIZE:  
XS - L, (XS 0-2, S 4-6, M 8-10, L 12-14)

PRICE:  
\$849.00

COURTNEY FORCE, NHRA FUNNY CAR DRIVER, JOHN FORCE RACING



## HPD-1 RACING SUIT DUAL CERTIFIED!



FIA and SFI 3.2A/5 certified. With Sports Car, Rally and Road Racing in mind, Simpson's lightweight 3-layer, HPD-1 racing suit is loaded with functionality and performance. Impressive features include raglan style epaulettes, heat relief panels in back of neck, 360° arm gussets, stretch panels at the elbow and thigh area, front half belt, and white/red or white/grey color combinations. Coordinating arm and leg cuffs and an attractive quilt stitch pattern finish out this suit. The HPD-1 is simplistic in design and loaded with functionality.

### COLORS

White/Red Trim, White/Grey Trim

### FABRIC

Satin/Twill

CODE:  
RS

SIZE:  
US: S - XL EURO: 48, 50, 52, 54

PRICE:  
\$599.00



## LEGEND II RACING SUIT

The Legend II is an affordable SFI.1 rated racing suit tailored to the needs of the racer. We have added distinctive styling and 3-point epaulets. This entry-level FR Cotton suit includes a wraparound collar and 3-point epaulets with Simpson branding. We have also included vertical quilting, 360° full arm gussets, straight leg cuffs and front pockets. Choose from a complete range of Adult and Youth sizes. Available with arm restraints – Special Order \$100 upcharge.

### COLORS

Solid Black, Black/Grey Combo (*not shown*)

### FABRIC

SFI-1 FR Cotton



YOUTH SIZES AVAILABLE 

CODE:  
**STD.LII**

SIZE:  
**S - XL**

PRICE:  
**\$199.95**

YOUTH LEGEND II AVAILABLE, SEE PAGE 71.

## SFI-1 CLASSIC RACING SUIT



The SFI-1 suit features our Classic 3-stripe design in woven Satin/Twill with a zippered breast pocket. (*2 piece shown*)

**FABRIC**  
Satin/Twill

### SFI-1 Classic

| CODE     | SIZE: S-XXL          | PRICE    |
|----------|----------------------|----------|
| 03 STD.6 | 1-PIECE              | \$319.00 |
|          | 15% UPCHARGE FOR XXL |          |
| 03 STD.6 | JACKET               | \$189.00 |
|          | 15% UPCHARGE FOR XXL |          |
| 03 STD.6 | PANT                 | \$149.00 |
|          | 15% UPCHARGE FOR XXL |          |



## SFI-15/SFI-20 DRAG RACING SUITS



Standard drag racing suits include contrasting piping, full arm gussets, SFI tag, built-in arm restraints and vertical stitching.

The suit is shown with box quilt and comes standard with vertical quilt.

### COLORS

Black, Red, Royal Blue (not shown)



### SFI-15 Drag Racing Suit

| CODE    | FABRIC  | PRICE      |
|---------|---|------------|
| STD.49T | SIGNATURE KNIT NOMEX® / 1-PIECE               | \$1,549.00 |
| STD.49T | SIGNATURE KNIT NOMEX® / 2-PIECE PANT & JACKET | \$1,599.00 |

### SFI-20 Drag Racing Suit

| CODE    | FABRIC  | BASE PRICE |
|---------|---|------------|
| STD.48T | SIGNATURE KNIT NOMEX® / 1-PIECE               | \$1,749.00 |
| STD.48T | SIGNATURE KNIT NOMEX® / 2-PIECE PANT & JACKET | \$1,799.00 |

## HOLESHOT 20 DRAG GLOVE



The Holeshot 20 Drag Glove is SFI 3.3/20 approved and made in the USA and is 20% lighter than the competition. Newly developed Nomex® technology with conforming stretch for improved dexterity.

**COLOR**  
Black



| CODE:        | SIZE:         | PRICE:          |
|--------------|---------------|-----------------|
| <b>37015</b> | <b>S - XL</b> | <b>\$319.95</b> |

## HOLESHOT 20 DRAG BOOTS



The Holeshot 20 Drag Boot is SFI 3.3/20 approved and made in the USA and is 50% lighter than standard drag boots. Newly developed Nomex® material stretches over the shoe for improved fit and comfort. Includes zipper and adjustment strap.

**COLOR**  
Black

| CODE:        | SIZE:         | PRICE:          |
|--------------|---------------|-----------------|
| <b>37021</b> | <b>S - XL</b> | <b>\$429.95</b> |

| FOOT SIZE | 5½-7" | 7-8½" | 8½-10" | 10-11½" | 11½-13" |
|-----------|-------|-------|--------|---------|---------|
| SHOE SIZE | S     | M     | M/L    | L       | XL      |



## UTV SPORT VINTAGE STYLE SUIT



UTV Suit features our popular 3 stripe retro styling  
 One-piece suit meets and exceeds SFI 3.2A/1 and SFI 5 3.2/5 requirements  
 Black Ankle and Wrist Cuffs  
 Standard Shoulder Epaulets  
 Red, Orange and Yellow racing stripes on driving suit arms

### SIZES

Small – XXLarge, 15% upcharge for XXL

### COLOR

Black Only

| CODE: | SIZE:           | BASE PRICE: |
|-------|-----------------|-------------|
| U3    | SFI 3.2/1 RATED | \$319.95    |

| CODE: | SIZE:           | BASE PRICE: |
|-------|-----------------|-------------|
| U4    | SFI 3.2/5 RATED | \$529.95    |

## CROSSOVER RACING SUIT

The Crossover suit is SFI.5 rated with multilayers of fire protection. Simpson branded at epaulets. Banded collar and straight leg cuffs. Back gusset is designed for comfort. Includes 360° arm gussets.

### COLORS

Black/White/Grey

### FABRIC

Satin/Twill



| CODE:  | SIZE:                       | PRICE:   |
|--------|-----------------------------|----------|
| STD.CO | S-XXXL (XXL, XXXL PLUS %15) | \$549.00 |

# RACING SUITS

## APEX KART RACING SUIT

The Apex Suit is ergonomically designed to offer resistance abrasion for karters and stylish visibility on the track. The fabric is lightweight, fade resistant and durable. Non-restrictive stretch panels enhance the racer's comfort.

### FEATURES

- Lightweight Cordura® construction is highly resistant to abrasion
- Soft mesh inner lining at the sleeve and thigh areas for comfort and breathability and maximum air flow
- Fully floating arms minimize bulk around the shoulders
- Knit wrist and ankle cuffs offer a sleek fit
- Fully adjustable collar and front belt
- Attractive modern style epaulets

### COLORS

Black w/Grey Trim, Red w/Grey Trim (*shown*)



CODE:  
AP

SIZE:  
S, M, L, XL

BASE PRICE:  
\$199.95

## APEX KART GLOVE

The Apex glove is styled for karting and enthusiasts and is not an SFI rated glove.

### COLORS

Black, Blue, Red



CODE:  
AX

SIZE:  
XS-XXL

PRICE:  
\$29.95

## APEX KART RACING JACKET



### FEATURES

- Jacket features extended back heatshield panel across shoulder area for added protection

### COLORS

Black, Red (*not shown*)

### FABRIC

Poly Duck

NO TPP RATING. NOT FIRE RETARDANT.



CODE:  
01 STD. K

SIZE:  
S - XXL 15% UPCHARGE FOR XXL

BASE PRICE:  
\$179.95

## JR/YOUTH RACING SUITS VISIT SIMPSONPERFORMANCE.COM FOR A COMPLETE SELECTION OF YOUTH SUITS

### HELIX YOUTH RACING SUITS

The Helix SFI 5 Youth driving suit is designed with athletic performance-enhancing features engineered to reduce weight and young driver restrictions. The Helix is available in Adult and Youth Sizing.

#### FEATURES

- SFI.5 Rated
- 270° arm and back gussets
- Knee and Inner Thigh Stretch Panels
- Lower back stress relief panel
- Upper back ventilation port
- No-bulk, weight-saving patch pockets and embroidered trim and logo.



CODE:  
**HX-Y**

SIZE:  
**XS - XL**

BASE PRICE:  
**\$399.00**

**COLOR**  
Black/Grey

**FABRIC**  
Satin/Twill

### SFI.5 BASIC AND PREMIUM YOUTH SUITS (NOT SHOWN)



#### FEATURES:

- Solid color suit
- Double racing stripes on arms and legs.
- Simpson logos on arms and cuffs
- Stylish inset pockets and banded collar
- Traditional cuff leg, basic model
- Straight leg cuff, premium model

#### COLOR SELECTION

Black, Blue and Red

CODE:  
**STD.Y4**  
**STD.P4**

SIZE:  
**BASIC MODEL, XS-XL**  
**PREMIUM MODEL, XS-XL**

PRICE:  
**\$269.95**  
**\$299.95**



### YOUTH LEGEND II SUIT



The Youth Legend II Suit is an affordable SFI.1 rated cotton firesuit tailored to the needs of the young racer. We have added distinctive styling and attractive color combinations. This quality sewn FR Cotton suit includes a wraparound collar and 3-point epaulets with Simpson branding. The Legend II has vertical quilting, 360° full arm gussets, straight leg cuffs and front pockets.

CODE:  
**STDY.LYII**

SIZE:  
**YXSM, YSM, YMED, YLG, YXL**

PRICE:  
**\$129.95**

SEE YOUTH SIZE CHART ON PAGE 62.

#### COLORS

Black with White trim, Black with Red trim

#### FABRIC

SFI-1 FR Cotton

### JR KART SUITS (NOT SHOWN)

Karting suits are not SFI rated. Constructed of 600 Denier Poly, single layer.

#### KART SUIT COLORS

Black, Blue and Red

CODE:  
**STD.Y1**  
**STD.P1**

SIZE:  
**BASIC MODEL, XS-XL**  
**PREMIUM MODEL, XS-XL**

BASE PRICE:  
**\$169.95**  
**\$199.95**

## MEMORY FIT UNDERWEAR



Our newest fire retardant memory fit underwear is race tested by NASCAR's pro racers. The unique memory fit fabric stretches both horizontally and vertically with great bounce back and becomes softer with each washing. You may want to order two sets, because this will quickly become your go-to underwear for added race protection.

### FEATURES

- SFI 3.3 Certified
- Made in the USA
- Nomex® blend provides added fire protection
- Anti-microbial treated
- No bulk, unique memory stretch provides built in comfort, while retaining shape
- Contrast stretch stitching for definition



### Memory Fit

| CODE  |                             | PRICE    |
|-------|-----------------------------|----------|
| 20123 | MEMORY FIT LONG SLEEVE TOP  | \$129.95 |
| 20124 | MEMORY FIT BOTTOM           | \$129.95 |
| 20125 | MEMORY FIT SHORT SLEEVE TOP | \$129.95 |



## LADIES FR BRA



Top is constructed of 4-way stretch Nomex® protective fabric and functions as an added layer of protection and improved comfort under a racing suit. This safe alternative to unisex undergarments is free of dangerous underwire, snaps and hooks. The Simpson sports top is designed with soft comfort in mind. The wide chest band and shoulders stay in place and are non-binding.

| CODE:        | SIZE:          | PRICE:         |
|--------------|----------------|----------------|
| <b>20606</b> | <b>XS - XL</b> | <b>\$79.95</b> |

| CHEST BAND SIZE  | 28"/30" | 30"/32" | 32"/34" | 34"/36" | 36"/40" |
|------------------|---------|---------|---------|---------|---------|
| SIMPSON BRA SIZE | XS      | S       | M       | L       | XL      |

\* WEARING NYLON OR POLYESTER WHILE RACING IS NOT RECOMMENDED. THESE MATERIALS CAN MELT WHEN EXPOSED TO EXTREME HEAT AND CAN CAUSE SERIOUS INJURIES.

**COLOR**  
Black





## CarbonX® ULTIMATE™ UNDERWEAR



CarbonX® delivers base layer products with extraordinary thermal protective properties, including CarbonX® Ultimate™ Underwear. (XXL available with 15% upcharge).

**COLOR**  
Black



LONG SLEEVE AVAILABLE

### CarbonX® Ultimate™

| CODE  | SIZE: S-XXL  | PRICE   |
|-------|--|---------|
| 20600 | LONG SLEEVE TOP  | \$99.95 |
| 20601 | BOTTOM   | \$99.95 |
| 20602 | SHORT SLEEVE CREW NECK TOP<br><i>NOT SFI CERTIFIED</i> | \$99.95 |

## 70Z. (NOT SHOWN)



**COLORS**  
Natural

### 70Z.

| CODE  | SIZE: S-XXL   | PRICE    |
|-------|---|----------|
| 20000 | LONG SLEEVE TOP<br>(XXL AVAILABLE WITH 15% UPCHARGE)    | \$119.95 |
| 20001 | FULL LENGTH BOTTOM<br>(XXL AVAILABLE WITH 15% UPCHARGE) | \$119.95 |

### SAFETY TIP

*Nomex® or CarbonX® underwear underneath the racing suit will dramatically improve Thermal Protection Performance (TPP) in the case of an accident involving fire.*

## NOMEX® UNDERWEAR

Our softest Nomex® knit for added comfort. Available in short or long sleeve and full length bottom. Meets SFI 3.3 and includes tag. Youth sizes available.



### Nomex® Underwear

| CODE  | SIZE: S-XXL   | PRICE   |
|-------|---|---------|
| 20100 | SHORT SLEEVE TOP<br>(XXL AVAILABLE WITH 15% UPCHARGE)<br><i>NOT SFI CERTIFIED</i> | \$99.95 |
| 20110 | LONG SLEEVE TOP<br>(XXL AVAILABLE WITH 15% UPCHARGE)                              | \$99.95 |
| 20101 | BOTTOM<br>(XXL AVAILABLE WITH 15% UPCHARGE)                                       | \$99.95 |

# RACING SUITS

## KEVLAR® SLEEVE & GLOVES

Designed for mechanics and crew members to help prevent cuts or burns while working a hurried pit stop. Can be worn under SFI-20 driving glove for added protection.



CODE:  
**39024**

SIZE:  
**ONE SLEEVE / ONE SIZE**

PRICE:  
**\$31.95**

CODE:  
**39020**

SIZE:  
**GLOVES / S - XL**

PRICE:  
**\$31.95**

## FUELER APRON

Includes adjustable Kevlar straps.

**COLOR**  
Silver



CODE:  
**39042**

SIZE:  
**ONE SIZE**

PRICE:  
**\$199.95**

## MECHANICS APRON

Polyester cotton blend. one upper pocket.  
Includes adjustable nylon straps.

**COLOR**  
Black



CODE:  
**39035**

SIZE:  
**ONE SIZE**

PRICE:  
**\$59.95**

## PROTECTIVE ACCESSORIES

### FIA NOMEX® BALACLAVA

Simpson's FIA Nomex Balaclava features a frontal design utilizing a dual layer of Nomex® for increased protection.

**COLOR**

Natural



#### FIA Nomex® Balaclava

| CODE   | TYPE           | PRICE   |
|--------|----------------|---------|
| 23004W | SINGLE EYEPORT | \$79.95 |
| 23005W | DUAL EYEPORT   | \$79.95 |

### CarbonX® BALACLAVA

Delivers Ultimate™ protection to the critical face and neck areas. Moisture wicking. Fits any full face helmet contour; wear in or out. Includes SFI tag.

**COLOR**

Black



#### Carbon x® Balaclava

| CODE   | TYPE           | PRICE   |
|--------|----------------|---------|
| 23000C | SINGLE EYEPORT | \$79.95 |
| 23003C | DUAL EYEPORT   | \$79.95 |

### MEMORY FIT BALACLAVA

The lightweight unique memory fit fabric stretches both horizontally and vertically for an overall comfortable fit.

**COLORS**

Black, White (not shown)



#### Memory Fit Balaclava

| CODE  | TYPE           | PRICE   |
|-------|----------------|---------|
| 23050 | SINGLE EYEPORT | \$79.95 |
| 23051 | DUAL EYEPORT   | \$79.95 |

### SFI NOMEX® BALACLAVA

Knitted from extra-plush Nomex®. Designed to be worn under most helmets. Single or dual eye port. Includes SFI tag. Youth sizes available.

**COLORS**

Natural, Black (not shown)



#### SFI Nomex® Balaclava

| CODE  | TYPE           | PRICE   |
|-------|----------------|---------|
| 23000 | SINGLE EYEPORT | \$79.95 |
| 23003 | DUAL EYEPORT   | \$79.95 |



### NOMEX® HELMET SKIRT

Dual layer material. Keeps dust and debris out of helmet. Attaches easily with speed fit system. Includes SFI tag.

**COLORS**

Black, Natural (not shown)



#### Nomex® Helmet Skirt

| CODE  | TYPE                  | PRICE   |
|-------|-----------------------|---------|
| 23012 | STANDARD              | \$99.95 |
| 23013 | CONTOURED             | \$99.95 |
| 23014 | LARGER HELMET OPENING | \$99.95 |

### CarbonX® HELMET SKIRT (NOT SHOWN)

Dual layer CarbonX® fleece material to comfortably protect neck and head.

**COLOR**

Black



#### Nomex® Helmet Skirt

| CODE   | TYPE                  | PRICE   |
|--------|-----------------------|---------|
| 23012C | STANDARD              | \$99.95 |
| 23013C | CONTOURED             | \$99.95 |
| 23014C | LARGER HELMET OPENING | \$99.95 |

## SONOMA PERFORMANCE CREW SHIRT

The Sonoma features a 3-button style and Simpson bar logo on the sleeve. Our most breathable fabric and tasteful contrast piping finish out this winning shirt.

### COLORS

Red/Black, Grey/Black, Blue/Black

|                       |                        |                               |
|-----------------------|------------------------|-------------------------------|
| CODE:<br><b>39018</b> | SIZE:<br><b>S - XL</b> | BASE PRICE:<br><b>\$44.95</b> |
|-----------------------|------------------------|-------------------------------|

|                       |                              |                               |
|-----------------------|------------------------------|-------------------------------|
| CODE:<br><b>39018</b> | SIZE:<br><b>XXL AND XXXL</b> | BASE PRICE:<br><b>\$47.95</b> |
|-----------------------|------------------------------|-------------------------------|



## TALLADEGA BUTTON DOWN

The Talladega features embroidered Simpson "S" logo, contrasting piping, attractive contrasting fabric (65% Poly, 35% Cotton), breathable mesh side panels and a stylish fit.

|                       |                        |                               |
|-----------------------|------------------------|-------------------------------|
| CODE:<br><b>39012</b> | SIZE:<br><b>S - XL</b> | BASE PRICE:<br><b>\$29.95</b> |
|-----------------------|------------------------|-------------------------------|

|                       |                            |                               |
|-----------------------|----------------------------|-------------------------------|
| CODE:<br><b>39012</b> | SIZE:<br><b>XXL - XXXL</b> | BASE PRICE:<br><b>\$32.95</b> |
|-----------------------|----------------------------|-------------------------------|



### COLORS

Red/Black, Grey/Black, Blue/Black, Orange/Black, Yellow/Black, Black/Black  
*Limited Stock on Select Colors*



## CUSTOM SUBLIMATED CREW SHIRTS

Simpson makes thousands of sublimated crew shirts every year at our state-of-the-art racing suit and crew apparel manufacturing facility in Harbor City, California. When it comes to crew apparel, we know our business. In keeping with the colorful and sponsor-rich world of racing, our sublimation process allows for endless design and color combinations. Our selection of fabrics and style are durable and comfortable. Our service is impeccable, our in-house design staff is the best.

### FEATURES

- Sublimated shirts are an economical option on high-volume orders
- Mesh, dazzle and poly poplin fabric choices
- Hidden snap-front closure or 1/4 zip
- Hidden snap-down collar
- Front welt pockets where applicable
- Larger sizes available, call for price quote



### Custom Sublimated Crew Shirts

CODE: SUBLIMATED CREW SHIRTS  
 SIZE: S - XXL  
 WOMEN'S SIZES ARE AVAILABLE  
 BASE PRICE BASED ON QUANTITY



## MOLECULE PERFORMANCE PRODUCTS



Molecule Car Cleaner removes road grime with ease, specifically addressing racing grime. Our detailer is easy to apply and quickly buffs to a glassy shine. Our fabric care products bond to Nomex® fabric to help repel flammable stains. Molecule Wash and Refresh keeps gear cleaner and safer by resisting contaminants that can degrade fabric performance. Protector sheds water, oils, fuels and dirt. Maintains fabric breathability. Fabric sunscreen reduces color fading caused by UV rays. Safe, water-based, patent pending formula. Visit [simpsonperformance.com](http://simpsonperformance.com) for the complete line of Molecule Labs™ products.

**NEW HELMET CARE KIT** includes: Light Duty Cleaner & Polish in one spray, Refresher to keep the inside of helmet clean, Anti-fog to keep the inside of visor clear, Rain Repel on outside of visor, includes microfiber towel



CAR DETAILER PRODUCTS



PERFORMANCE FABRIC CARE

### Helmet and Shield Care

| CODE   | TYPE                       | SIZE        | PRICE   |
|--------|----------------------------|-------------|---------|
| MLHCK4 | <b>NEW</b> HELMET CARE KIT | KIT         | \$24.95 |
| MLHCP4 | HELMET CLEANER/POLISH      | 4 OZ. SPRAY | \$6.95  |
| MLHFR4 | HELMET FABRIC REFRESH      | 4 OZ. SPRAY | \$6.95  |
| MLHRR4 | HELMET RAIN REPEL          | 4 OZ. SPRAY | \$6.95  |
| MLHAF4 | HELMET ANTI FOG            | 4 OZ. SPRAY | \$6.95  |

### Car Care

| CODE    | TYPE     | SIZE   | PRICE  |
|---------|----------|--------|--------|
| MLDET16 | DETAILER | 16 OZ. | \$9.95 |
| MLCLE16 | CLEANER  | 16 OZ. | \$9.95 |

### Protective Fabric Care

| CODE    | TYPE  | SIZE         | PRICE   |
|---------|---|--------------|---------|
| MLWK161 | WASH KIT: INCLUDES 16 OZ. WASH AND 16 OZ. SPOT REMOVER  | 16 OZ.       | \$34.95 |
| MLWTK44 | TRIAL WASH KIT: INCLUDES 4 OZ. WASH AND 4 OZ. SPOT REMOVER                                      | 4 OZ.        | \$9.95  |
| MLWA16  | WASH  | 16 OZ.       | \$19.95 |
| MLWAIG  | <b>NEW</b> GALLON SIZE WASH   | 1 GAL.       | \$49.95 |
| MLSP16  | SPOT REMOVER  | 16 OZ. SPRAY | \$19.95 |
| MLRE16  | REFRESHER   | 16 OZ. SPRAY | \$19.95 |
| MLPR16  | PROTECTOR   | 16 OZ. SPRAY | \$29.95 |
| MLCK1   | COMPLETE CARE KIT: INCLUDES 4 OZ. SPOT REMOVER, 16 OZ. WASH, 16 OZ. REFRESHER, 16 OZ. PROTECTOR | 16 OZ.       | \$69.95 |

# HOLD ON FOR THE RIDE

GLOVES

## DNA GLOVE

The DNA Glove is a high-performance driving glove constructed using knit Nomex® that conforms to each individual driver's hands for a unique custom fit. SFI 3.3/5 certified, the DNA glove features external seams, tapered and precurved fingers, precurved palm, exclusive DNA design silicone palm and finger grips, strategically placed knuckle and wrist bone padding and performance-inspired style lines. Wear the DNA for unmatched comfort & performance.

### COLORS

Black/White, Black/Blue, Black/Red



SIMPSON GLOVES  
FEATURING  
**NOMEX**  
®



CODE:  
**DG**

SIZE:  
**S-XL**

PRICE:  
**\$189.95**



## THE VORTEX GLOVE

SFI 3.3/5 rated and FIA Approved professional racing glove with Nomex® construction. Strategically placed wristbone padding provides additional protection. External seams and precurved palms provide comfort. Tapered and precurved fingers and fourchettes give the driver excellent control. Silicone palm gripper design and striking embroidered knuckle logo.

### COLORS

White/Black or White/Grey, both with Red Premium Trim design



SIMPSON GLOVES  
FEATURING  
**NOMEX**  
®



CODE:  
**VR**

SIZE:  
**XS - XXL**

PRICE:  
**\$169.95**

CODE:  
**VR-F**

SIZE:  
**FIA APPROVED**

PRICE:  
**\$179.95**



## PREDATOR GLOVE

Lightweight Nomex® construction for ultimate comfort and fit. Digital fire-resistant leather with individual performance stress points. All Nomex®, extra-long gauntlet with forearm cuff for custom fit.

### COLORS

Black, White



SIMPSON GLOVES  
FEATURING  
**NOMEX**  
®

CODE:  
**20800**

SIZE:  
**S - XL**

PRICE:  
**\$139.95**





## WHEELER GLOVE *NEW LONGER GAUNTLET*



Certified to SFI 3.3/5 standard, the aggressively styled Wheeler Racing Glove features minimal seam construction and optimized levels of grip via a newly designed leather palm and fingers.

### FEATURES

SFI 3.3/5 Certified  
Fire-resistant aramid fiber main construction  
Mid length gauntlet with convenient pull tab

### COLORS

Black/Red and Black/White

CODE:  
WG

SIZE:  
XS - XXL

PRICE:  
\$149.95



## COMPETITOR GLOVE

Nomex® Construction with a distinctive white trim. The silicone palm and touchpoints give superior grip and limited bunching. Available with inside and outside seams.

### COLORS

Black, Pink, White, Red



### Competitor Glove

CODE  
21300

FITS  
S - XL, ALL COLORS  
XXL, BLACK ONLY

PRICE  
\$149.95

21300-0

REVERSED SEAM

\$149.95



## THE HI-VIS GLOVE



The Hi-Vis glove has been developed for professional drivers who like the feel of an all-leather palm. SFI 3.3/5 Rated Racing Glove with Nomex® construction.

### COLORS

Black w/Yellow Trim, Yellow w/Black Trim  
*While supplies last.*



CODE:  
HV

SIZE:  
XS - XXL

PRICE:  
\$119.95



### GLOVE SIZE CHART



| SIZE   | INCHES      |
|--------|-------------|
| XXS    | 5" TO 6"    |
| XS     | 6" TO 7"    |
| SMALL  | 7" TO 8½"   |
| MEDIUM | 8" TO 9½"   |
| LARGE  | 9" TO 10½"  |
| XL     | 10" TO 11½" |



## IMPULSE GLOVE

The Impulse Professional racing glove provides protection and grip in all the right areas. SFI 5 Rated Racing Glove with Nomex® construction. Exceptionally soft palm constructed of goat leather. Inside Seams.

### COLORS

Red, Blue, Black



SIMPSON GLOVES  
FEATURING  
**NOMEX**  
SFI 5

CODE:  
**IM**

SIZE:  
**XXS - XXL**

PRICE:  
**\$99.95**

## SUPER SPORT GLOVE

The Super Sport is an entry-level racing glove that protects and performs. SFI 3.3/1 Rated Racing Glove with Nomex® construction and silicone graphics finish out design. Available with inside seams only.

### COLORS

Black w/White Graphic Trim



SIMPSON GLOVES  
FEATURING  
**NOMEX**  
SFI 3.3/1

CODE:  
**SS**

SIZE:  
**XS - XL**

PRICE:  
**\$84.95**

## YOUNG GUN YOUTH GLOVE

Double-layer Nomex® knit construction with an SFI 3.3/5 rating. The Young Gun is super stylish and super protective. Available in kids' sizing Small, Medium and Large.

### COLOR

Black with White with Silver accents



SIMPSON GLOVES  
FEATURING  
**NOMEX**  
SFI 3.3/5

CODE:  
**YGY**

SIZE:  
**S - L**

PRICE:  
**\$79.95**

## HOLESHOT 20 DRAG GLOVE

Made in the USA. Meets SFI 20. 20% lighter than the competition. Newly developed Nomex® technology with conforming stretch for improved dexterity.

### COLOR

Black



SIMPSON GLOVES  
FEATURING  
**NOMEX**  
SFI 20



CODE:  
**37015**

SIZE:  
**S - XL**

PRICE:  
**\$319.95**

## WRENCHER II MECHANIC GLOVE

One tough glove built for everyday wear for riding your bike or UTV or hanging out in the garage. The Wrencher II is not fire-retardant. The Wrencher II runs small. Order one size up for best fit.

### COLOR

Black



CODE:  
**39034**

SIZE:  
**S - XL**

PRICE:  
**\$24.95**

## CUSTOM GLOVE PROGRAM

You can order our Team Style SFI.5 certified glove with your own team logos and colors. See our stylish and functional Team Glove here. Our Team Glove features Nomex™ construction with silicone palm and touchpoints and outside seam construction.

### COLORS

We offer multiple color choices. Contact us for details.

### HOW IT WORKS

#### 1. CHOOSE YOUR COLOR

Choose from the Nomex® constructed Black/White Team Glove. Featuring superior grip with silicone palm and touchpoints. This SFI certified glove is a popular choice for race teams.



GLOVE IS SHOWN IN OPTIONAL CUSTOM COLOR, YELLOW.

#### 2. CHOOSE YOUR LOGO POSITION

Place your logo/art in the 3" by 7" print area. Also choose Position 1 or 2 for the Simpson logo.

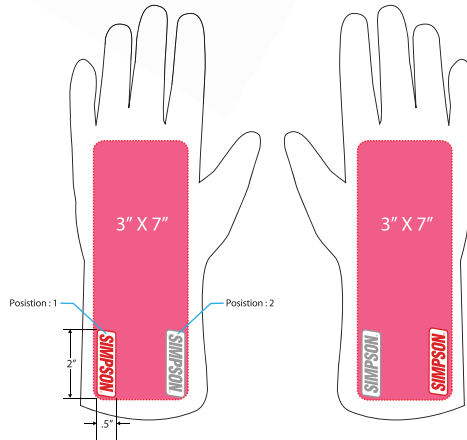

Large area for your artwork. Excellent position for camera exposure.

#### 3. CHOOSE YOUR QUANTITY

Cost is based on your total quantity of pairs ordered with a unique print. Pricing is also based on the Simpson logo being on the glove. Removal of the Simpson logo will cost \$225 per pair with no quantity price breaks.

|          |        |            |          |
|----------|--------|------------|----------|
| PAIR(S): | 1 – 6  | PRICE PER: | \$195.00 |
| PAIRS:   | 7 – 12 | PRICE PER: | \$185.00 |
| PAIRS:   | 13 +   | PRICE PER: | \$175.00 |

#### 4. CALL SIMPSON

CALL **1.888.872.7848** to place your order. You will be required to supply your custom, hi-resolution artwork.



# LACE UP TO GEAR UP



SHOES

# SHOES

## DNA SHOE

The DNA Shoe is our newest slim, lightweight, form-fitting performance shoe with heat-releasing perforated panels designed to meet the needs of today's fastest drivers.

### FEATURES

- SFI 3.3/5 certified
- DuPont™ Nomex® lining
- Plush tongue and ankle padding
- Exclusive pedal-sensitive rubber sole

### COLORS

Black/White, Black/Red



CODE:  
DA

SIZE:  
4 - 14 (INCLUDES 1/2 SIZES)

PRICE:  
\$199.95

## REDLINE SHOE

The Redline shoe is SFI approved for racing and features a performance-enhancing, streamline design that is comfortable and pliable.

### FEATURES

- Manufactured of top grain leather and fire-retardant Nomex®
- SFI, FIA approved
- Hidden laces
- Textured bumper panels
- Single large Velcro ankle strap

### COLORS

Black/White, Black/Grey



CODE:  
RL

SIZE:  
6 - 14 (INCLUDES 1/2 SIZES)

PRICE:  
\$179.95

CODE:  
RL-F

FIA, BLACK/GREY

PRICE:  
\$179.95

## HIGHTOP SHOE *NEW TAKE ON OUR CLASSIC STYLE*



The Hightop is a high-top design with a satin suede upper and is SFI 3.3/5 approved. The inner fleece lining is FR. There is a triple layer anterior toe area for added wear protection with additional reinforcements in the heel and lace guard. Double speed-fit closure. The outer sole is a non-slip, super-sensitive polyurethane sole with posi-grip traction.

### COLORS

Black, Blue, Red



|                       |   |                          |
|-----------------------|---|--------------------------|
| CODE:<br><b>28000</b> | SIZE:<br><b>4 - 14 BLACK (INCLUDES 1/2 SIZES)</b> | PRICE:<br><b>\$99.95</b> |
|-----------------------|---|--------------------------|

|                       |   |                          |
|-----------------------|---|--------------------------|
| CODE:<br><b>28000</b> | SIZE:<br><b>8 - 12 BLUE, RED (INCLUDES 1/2 SIZES)</b> | PRICE:<br><b>\$99.95</b> |
|-----------------------|---|--------------------------|

## ADRENALINE SHOE



The Adrenaline is made from satin suede with a fleece fire-retardant lining and is SFI 3.3/5 approved. Triple layer anterior toe area for added wear protection with additional reinforcements in the heel and a speedfit lace closure. The low cut Achilles support gives maximum flexibility and comfort. The non-slip, super-sensitive polyurethane sole with posi-grip traction keeps you grounded.

### COLOR

Black



|                    |   |                           |
|--------------------|---|---------------------------|
| CODE:<br><b>AD</b> | SIZE:<br><b>4 - 14 (INCLUDES 1/2 SIZES)</b> | PRICE:<br><b>\$139.95</b> |
|--------------------|---|---------------------------|

|                    |  |                           |
|--------------------|--|---------------------------|
| CODE:<br><b>AD</b> | SIZE:<br><b>YOUTH 1 - 3 (NO 1/2 SIZES)</b> | PRICE:<br><b>\$109.95</b> |
|--------------------|--|---------------------------|

## MIDTOP SHOE



The Midtop shoe is SFI 3.3/5 certified. A single speed-fit closure locks away laces. Achilles relief cut for maximum flexibility. Fleece FR lining. Satin suede toe, heel and lace guard reinforcements. Triple layer anterior toe area for added wear protection. Non-slip, super-sensitive polyurethane sole with posi-grip traction.

### COLORS

Two-tone: Black and Grey.



|                    |   |                          |
|--------------------|---|--------------------------|
| CODE:<br><b>MT</b> | SIZE:<br><b>6 - 14 (INCLUDES 1/2 SIZES)</b> | PRICE:<br><b>\$99.95</b> |
|--------------------|---|--------------------------|

## STEALTH SPRINT SHOE

The softer leather Stealth is SFI 3.3/5 approved with a modified lace guard for those who prefer a futuristic look. The high-top design features Simpson's easy to clean leather upper and super smooth leather toe, lace and heel guard reinforcements. The dual speedfit closure and exclusive EnviroGuard lace cover protects the seven hole lace-up. The internal construction features flat seams and fleece fire-retardant lining with an athletic insert. The outer sole is constructed of Type R polyurethane in a posi-grip pattern.

**COLOR**  
Black



SIMPSON SHOES  
FEATURING  
**NOMEX**  
®

CODE:  
**SP**

SIZE:  
**6 - 14 (HALF SIZES AVAILABLE 8-12)**

PRICE:  
**\$149.95**



## HOESHOT 20 DRAG BOOT

The Holeshoot Drag Boot is SFI 3.3/20 approved and made in the USA, and is 50% lighter than standard drag boots. Newly developed Nomex® material stretches over the shoe for improved fit and comfort. Includes zipper and upper adjusting strap.

**COLOR**  
Black



SIMPSON SHOES  
FEATURING  
**NOMEX**  
®



CODE:  
**37021**

SIZE:  
**S - XL**

PRICE:  
**\$429.95**

| FOOT SIZE | 5½-7" | 7-8½" | 8½-10" | 10-11½" | 11½-13" |
|-----------|-------|-------|--------|---------|---------|
| SHOE SIZE | S     | M     | M/L    | L       | XL      |



### SHOE SIZE CONVERSION CHART

|            |      |      |      |      |      |      |      |      |      |      |      |      |      |      |      |      |      |      |    |      |      |  |
|------------|------|------|------|------|------|------|------|------|------|------|------|------|------|------|------|------|------|------|----|------|------|--|
| U.S. MEN   | 4    | 4.5  | 5    | 5.5  | 6    | 6.5  | 7    | 7.5  | 8    | 8.5  | 9    | 9.5  | 10   | 10.5 | 11   | 11.5 | 12   | 12.5 | 13 | 13.5 | 14   |  |
| U.S. WOMEN | 5.5  | 6    | 6.5  | 7    | 7.5  | 8    | 9    | 9.5  | 10   | 10.5 | 11   | 11.5 | 12   | 12.5 | 13   | 13.5 | 14   |      |    |      |      |  |
| EURO       | 36   | 36.5 | 37   | 37.5 | 38   | 38.5 | 39   | 39.5 | 40   | 40.5 | 41   | 41.5 | 42   | 42.5 | 43   | 43.5 | 44   | 44.5 | 45 | 45.5 | 46   |  |
| UK         |      |      | 4    | 4.5  | 5    | 5.5  | 6    | 6.5  | 7    | 7.5  | 8    | 8.5  | 9    | 9.5  | 10   | 10.5 | 11   | 11.5 | 12 | 12.5 | 13   |  |
| CM         | 23.1 | 23.5 | 23.8 | 24.1 | 24.5 | 24.8 | 25.1 | 25.4 | 25.7 | 26   | 26.7 |      | 27.3 |      | 27.9 |      | 28.6 |      |    |      | 29.2 |  |
| IN         | 9¼   | 9¼   | 9½   | 9½   | 9¾   | 9¾   | 9¾   | 10   | 10¼  | 10¼  | 10½  |      | 10¾  |      | 11   |      | 11¼  |      |    |      | 11½  |  |

## NEW BLACKTOP SHOE

Simpson's newest racing inspired multi-surface shoe for everyday wear both on and off the track is constructed of leather and suede uppers with extra comfort insoles for those long days on your feet. The Blacktop soles are designed for grip, capable of handling rocky, wet, and smooth surfaces with ease.



CODE: **BT**      SIZE: **8 - 14 (INCLUDES 1/2 SIZES)**      PRICE: **\$69.95**

**FEATURES**  
 Extra Comfort Insoles for Long Wear  
 Durable Bottom Soles with Extra Grip  
 Order ½ size up for wide width

**COLOR**  
 Black



## PIT BOX SHOE

The Pit Box shoe is engineered to meet the demands of today's over-the-wall athletes. Lightweight but extremely tough, this shoe is made to be quick & hold up to the demands of any pit crew.



CODE: **PB**      SIZE: **7 - 17 (INCLUDES 1/2 SIZES)**      PRICE: **\$149.95**

**FEATURES**  
 SFI 3.3/5 certified  
 Velcro closure  
 Internal ankle protection  
 Lace protection  
 Durable toe guard  
 Speed styling and design

**COLOR**  
 Black

## GARAGE CREW SHOE

Simpson's Garage Crew Shoe resists abrasion and provides traction and stability in an everyday work environment. It is all in a day's work when you wear Simpson's crew shoe. Our Garage Crew Shoe is made for superior service with an upper that features suede and abrasion-resistant canvas. A durable cushioned interior wicks away moisture, while non-marking, slip-resistant outer soles provide reliable traction.



CODE: **57000**      SIZE: **4 - 14 (INCLUDES 1/2 SIZES)**      PRICE: **\$69.95**

**FEATURES**  
 Round soft toe and cushioned soles  
 Non-marking, slip-resistant outer sole

**COLOR**  
 Black

**CARE**  
 We recommend Molecule Spot Cleaner and Molecule Refresh products to keep your Simpson shoes looking their best.

\*Shoe longevity varies based on user wear

## FR SHOE LACES

**COLOR**  
 Black



CODE: **FRLACES**      SIZE: **48"**      PRICE: **\$4.95**

## ACCESSORIES

### VO2FX™ 15/20 COMPRESSION SOCKS



Available in fire-retardant and non-FR crew models. Provides increased endurance. Prevents swelling caused by extended sitting or driving. Encourages increased circulation which increases oxygenated blood to muscle tissues, tendons and joints of the lower extremities. Reduces muscle soreness and danger of blood clots. COOLMAX® moisture management fabric keeps feet cool and dry. No in-shoe sliding.



#### Compression Socks

| CODE  | FITS                                    | PRICE   |
|-------|---|---------|
| 23030 | SFI 3.3 FIRE-RETARDANT COMPRESSION SOCK | \$44.95 |
| 23041 | NON-FR CREW COMPRESSION SOCK            | \$14.95 |

**SIZES**  
M - XL

23041

23030

### SFI 3.3 CarbonX® SOCKS



Knitted from patented CarbonX® yarn and flame-resistant, super-washed merino wool. Reinforced toe and heel, cushioned sole. CarbonX® is black in its pure form and cannot be dyed any other color.

| CODE:  | SIZE:              | PRICE:  |
|--------|--------------------|---------|
| 23029C | ONE SIZE FITS MOST | \$44.95 |

**COLOR**  
Black



### NOMEX® SOCKS



Knitted from Nomex.

**COLORS**  
Black, White



#### Nomex® Socks

| CODE   | FITS                                   | PRICE   |
|--------|--|---------|
| 23027  | ONE SIZE FITS ALL TUBE SOCKS           | \$29.95 |
| 23032A | SFI NOMEX WHITE TUBE (IMAGE NOT SHOWN) | \$39.95 |



# RACE FAST WE'LL HANDLE THE STOP

HARNESS, NETS  
AND DRAG CHUTES



# HARNESSES, NETS AND DRAG CHUTES

## SIMPSON HARNESSES

Simpson Harnesses are SFI Approved. Upgrade to Platinum Plus Camlock Systems, Latch & Link, Sprint, Drag Racing and more. If you are particular about your harnesses, call Simpson. We will make a custom set just for you and deliver quickly.



See Page 92 for custom belt order form.



CODE SB5.LUC.722BA  
 TYPE CAMLOCK STYLE 7-POINT W/T-BAR, 2" BLACK  
 PRICE \$415.00



CODE SB5.LUL.722BAT  
 TYPE LATCH & LINK STYLE 7-POINT DIRT STYLE W/T-BAR, 2"-3", BLACK  
 PRICE \$265.00



CODE SB6.LDC.722BAT  
 TYPE CAMLOCK NASCAR STYLE 7-POINT W/T-BAR, 2"-3", BLACK  
 PRICE \$599.00

# HARNESSES, NETS AND DRAG CHUTES



CODE SB6.LUC.722BAF  
 TYPE CAMLOCK FORMULA STYLE 7-POINT W/T-BAR, 2"-3", BLACK  
 PRICE \$579.00



|                |   |                |
|----------------|---|----------------|
| CODE SB.100.5A | TYPE QUARTER MIDGET STYLE LATCH & LINK, W/ALUMINUM ADJUSTERS, 2", BLACK | PRICE \$180.00 |
| SB.100.5       | QUARTER MIDGET STYLE W/STEEL ADJUSTERS, 2", BLACK                       | \$105.00       |



|                |   |                |
|----------------|---|----------------|
| CODE SB.101.5A | TYPE JUNIOR DRAGSTER STYLE CAMLOCK, W/ALUMINUM ADJUSTERS, 2", BLACK | PRICE \$245.00 |
| SB.101.5       | JUNIOR DRAGSTER STYLE CAMLOCK, W/STEEL ADJUSTERS, 2", BLACK         | \$170.00       |



|                |   |                |
|----------------|---|----------------|
| CODE SB5.51204 | TYPE LEFT SIDE RATCHET SYSTEM ALUMINUM ADJUSTERS DIRT TRACK STYLE, 2"-3", BLACK | PRICE \$379.95 |
|----------------|---|----------------|

# HARNESSES, NETS AND DRAG CHUTES



## Platinum Plus Custom Belt Order Form

**BLACK BELTS ONLY.** Complete online or print, complete, scan and email to [custombelts@teamsimpson.com](mailto:custombelts@teamsimpson.com). We will call you with an estimate before beginning work on your belts. Questions? Call 800-654-7223.

|       |        |        |              |              |
|-------|--------|--------|--------------|--------------|
| NAME: | PHONE: | EMAIL: | TYPE OF CAR: | SALES ORDER: |
|-------|--------|--------|--------------|--------------|

|                             |                                   |                                   |                                   |                                |   |
|-----------------------------|-----------------------------------|-----------------------------------|-----------------------------------|--------------------------------|---|
| <b>STEP 1</b> CERTIFICATION | SFI RATING:                       |                                   |                                   | MATERIAL:                      |   |
|                             | <input type="checkbox"/> SFI 16.1 | <input type="checkbox"/> SFI 16.5 | <input type="checkbox"/> SFI 16.6 | <input type="checkbox"/> LIGHT | <input type="checkbox"/> HEAVY (OVER 200 LBS) |

|   |                               |                                |                               |                                |                               |                             |
|---|-------------------------------|--------------------------------|-------------------------------|--------------------------------|-------------------------------|-----------------------------|
| <b>STEP 2</b> LAP BELT STYLE<br><small>For fixed length, non-adjustables: Call 1.800.473.7077</small> | SINGLE PULL DOWN:             |                                | SINGLE PULL UP:               |                                | DOUBLE PULL:                  |                             |
|   | <input type="checkbox"/> LEFT | <input type="checkbox"/> RIGHT | <input type="checkbox"/> LEFT | <input type="checkbox"/> RIGHT | <input type="checkbox"/> DOWN | <input type="checkbox"/> UP |

|                              |                                 |                                 |
|------------------------------|---------------------------------|---------------------------------|
| <b>STEP 3</b> LAP BELT WIDTH | <input type="checkbox"/> 3 INCH | <input type="checkbox"/> 2 INCH |
|------------------------------|---------------------------------|---------------------------------|

|                                  |                                   |  |                                |  |                                      |
|----------------------------------|-----------------------------------|--|--------------------------------|--|--------------------------------------|
| <b>STEP 4</b> LAP BELT ADJUSTERS | <input type="checkbox"/> ALUMINUM |  | <input type="checkbox"/> STEEL |  | <input type="checkbox"/> SEWN ANCHOR |
|----------------------------------|-----------------------------------|--|--------------------------------|--|--------------------------------------|

|                              |                                  |  |                                  |  |                                      |  |
|------------------------------|----------------------------------|--|----------------------------------|--|--------------------------------------|--|
| <b>STEP 5</b> LAP BELT MOUNT | <input type="checkbox"/> BOLT IN |  | <input type="checkbox"/> CLIP IN |  | <input type="checkbox"/> WRAP AROUND |  |
|------------------------------|----------------------------------|--|----------------------------------|--|--------------------------------------|--|

|                               |  |  |                                  |                                       |
|-------------------------------|--|--|----------------------------------|---------------------------------------|
| <b>STEP 6</b> LAP BELT LENGTH | <input type="checkbox"/> UNIVERSAL     |  | ADJUSTER (SHORT LAP LENGTH):     |                                       |
|                               | <input type="checkbox"/> CUSTOM: _____ |  | <input type="checkbox"/> IN SEAT | <input type="checkbox"/> OUTSIDE SEAT |

|                           |                                       |   |   |   |  |
|---------------------------|---------------------------------------|---|---|---|--|
| <b>STEP 7</b> BUCKLE TYPE | <input type="checkbox"/> LATCH & LINK | <input type="checkbox"/> LATCH & LINK<br><small>DBL. PULL DOWN ONLY</small> | <input type="checkbox"/> CAM LOCK<br>STANDARD | <input type="checkbox"/> ROTARY<br>CAM LOCK | <input type="checkbox"/> CAM LOCK<br>DOUBLE PULL<br>DOWN |
|                           |                                       |   |   |   |  |
|                           | CAM LOCK LOCATION:                    |   | <input type="checkbox"/> RIGHT SIDE           | <input type="checkbox"/> BOTTOM             |  |

### SUB BELTS

|                               |                            |  |                            |  |                            |  |
|-------------------------------|----------------------------|--|----------------------------|--|----------------------------|--|
| <b>STEP 8</b> MOUNTING POINTS | <input type="checkbox"/> 5 |  | <input type="checkbox"/> 6 |  | <input type="checkbox"/> 7 |  |
|-------------------------------|----------------------------|--|----------------------------|--|----------------------------|--|

|                             |                                  |                                |                                 |
|-----------------------------|----------------------------------|--------------------------------|---------------------------------|
| <b>STEP 9</b> MOUNTING TYPE | <input type="checkbox"/> FORMULA | <input type="checkbox"/> T BAR | <input type="checkbox"/> V TYPE |
|                             |                                  |                                |                                 |

### SHOULDER BELTS

|                           |                                   |  |                                 |  |  |  |
|---------------------------|-----------------------------------|--|---------------------------------|--|--|--|
| <b>STEP 10</b> BELT WIDTH | <input type="checkbox"/> 2/2 INCH |  | <input type="checkbox"/> 3 INCH |  | <input type="checkbox"/> DUAL SHOULDER |  |
|                           | <input type="checkbox"/> 2/3 INCH |  |                                 |  |  |  |

|                              |                                   |  |                                |  |                                   |                                   |
|------------------------------|-----------------------------------|--|--------------------------------|--|-----------------------------------|-----------------------------------|
| <b>STEP 11</b> BELT ADJUSTER | <input type="checkbox"/> ALUMINUM |  | <input type="checkbox"/> STEEL |  | <input type="checkbox"/> 2/2 INCH | <input type="checkbox"/> 2/3 INCH |
|------------------------------|-----------------------------------|--|--------------------------------|--|-----------------------------------|-----------------------------------|

|                           |  |                                    |                                  |  |  |  |
|---------------------------|--|------------------------------------|----------------------------------|--|--|--|
| <b>STEP 12</b> BELT MOUNT | <input type="checkbox"/> BOLT IN<br><small>(W/3 BAR)</small> |                                    | <input type="checkbox"/> CLIP IN |  | <input type="checkbox"/> WRAP AROUND<br><small>(NO ANCHOR)</small> |  |
|                           | <input type="checkbox"/> SEWN ANCHOR                         | <input type="checkbox"/> SEWN LOOP |                                  |  |  |  |

|                            |   |  |  |
|----------------------------|---|--|--|
| <b>STEP 13</b> BELT LENGTH | <input type="checkbox"/> STANDARD (MOST COMMON) | <input type="checkbox"/> CUSTOM: _____ |  |
|----------------------------|---|--|--|

|                          |                                       |  |   |  |   |
|--------------------------|---------------------------------------|--|---|--|---|
| <b>STEP 14</b> BELT PULL | <input type="checkbox"/> FOLD OVER    |  | <input type="checkbox"/> LOOP             |  | <input type="checkbox"/> COVERED WITH NOMEX®<br><small>(OPTIONAL)</small> |
|                          | TITANIUM SPACERS:                     |  |   |  |   |
|                          | <input type="checkbox"/> STEP BUSHING |  | <input type="checkbox"/> SHOULDER BUSHING |  | <input type="checkbox"/> SHOULDER COMBO SET                               |

## SIMPSON BLACK



Simpson is offering the following SFI 16.1 models with black hardware

### 3" LATCH & LINK SYSTEM



| CODE      | TYPE                            | PRICE    |
|-----------|---------------------------------|----------|
| 29063BK1X | 55" SEAT BELT PULL DOWN BOLT-IN | \$129.95 |



### 3" LEVER OR ROTARY CAMLOCK SYSTEMS



| CODE       | TYPE   | PRICE    |
|------------|--------|----------|
| 29110BKL1X | LEVER  | \$249.95 |
| 29110BKR1X | ROTARY | \$249.95 |



| CODE       | TYPE   | PRICE    |
|------------|--------|----------|
| 29110BKL3X | LEVER  | \$274.95 |
| 29110BKR3X | ROTARY | \$274.95 |



| CODE       | TYPE   | PRICE    |
|------------|--------|----------|
| 29110BKL2X | LEVER  | \$264.95 |
| 29110BKR2X | ROTARY | \$264.95 |



## 2" LEVER OR ROTARY CAMLOCK SYSTEMS WITH CAMLOCK CLIP ADJUSTERS



| CODE       | TYPE   | PRICE    |
|------------|--------|----------|
| 29400BKL1X | LEVER  | \$299.95 |
| 29400BKR1X | ROTARY | \$299.95 |



| CODE       | TYPE   | PRICE    |
|------------|--------|----------|
| 29400BKL2X | LEVER  | \$314.95 |
| 29400BKR2X | ROTARY | \$314.95 |



| CODE       | TYPE   | PRICE    |
|------------|--------|----------|
| 29400BKL2X | LEVER  | \$314.95 |
| 29400BKR2X | ROTARY | \$314.95 |



| CODE       | TYPE   | PRICE    |
|------------|--------|----------|
| 29400BKL3X | LEVER  | \$324.95 |
| 29400BKR3X | ROTARY | \$324.95 |



SIMPSON PET RESTRAINTS AVAILABLE AT  
[SIMPSONPERFORMANCE.COM](http://SIMPSONPERFORMANCE.COM)

## ROTARY SERIES

### COLORS

Black, Platinum



### Rotary Series

| CODE    | TYPE                              | PRICE    |
|---------|-----------------------------------|----------|
| 29118S0 | PULL DOWN BOLT-IN, 6-PT, BLACK    | \$249.95 |
| 29119S0 | PULL UP BOLT-IN, 6-PT, BLACK      | \$249.95 |
| 29218SP | PULL DOWN BOLT-IN, 6-PT, PLATINUM | \$259.95 |
| 29219SP | PULL UP BOLT-IN, 6-PT, PLATINUM   | \$259.95 |

## ROTARY SERIES WITH 2" UPPERS



### Rotary Series with 2" Uppers

| CODE    | TYPE                           | PRICE    |
|---------|--------------------------------|----------|
| 29828S0 | PULL DOWN BOLT-IN, 6-PT, BLACK | \$249.95 |
| 29829S0 | PULL UP BOLT-IN, 6-PT, BLACK   | \$249.95 |

## LATCH FX SERIES

### FEATURE

Can be made with 2" upper shoulder Harness for Head Restraints



### Latch FX Series

| CODE    | TYPE                              | PRICE    |
|---------|-----------------------------------|----------|
| 29073S0 | PULL DOWN BOLT-IN, 6-PT, BLACK    | \$159.95 |
| 29073SP | PULL DOWN BOLT-IN, 6-PT, PLATINUM | \$164.95 |

## LATCH & LINK SERIES

### FEATURE

Can be made with 2" upper shoulder Harness for Head Restraints

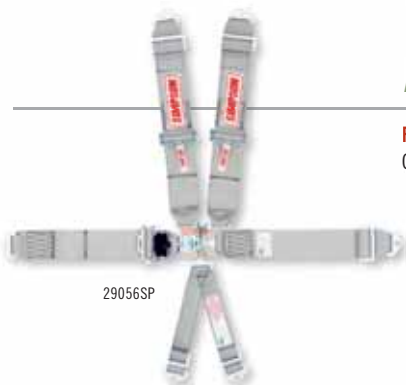

### Latch & Link Series

| CODE    | TYPE                              | PRICE    |
|---------|-----------------------------------|----------|
| 29054S0 | PULL DOWN BOLT-IN, 6-PT, BLACK    | \$159.95 |
| 29055S0 | PULL UP BOLT-IN, 6-PT, BLACK      | \$159.95 |
| 29056SP | PULL DOWN BOLT-IN, 6-PT, PLATINUM | \$164.95 |
| 29057SP | PULL UP BOLT-IN, 6-PT, PLATINUM   | \$164.95 |

## SPORT CAMLOCKS



**COLORS**  
Black, Blue, Red



29107 5-POINT

### Sport Camlocks

| CODE  | TYPE                                  | PRICE    |
|-------|---------------------------------------|----------|
| 29107 | 55" BOLT-IN SPORT CAMLOCK, 5-PT BLACK | \$189.95 |
| 29212 | 55" BOLT-IN SPORT CAMLOCK, 6-PT BLACK | \$199.95 |

## LEVER CAMLOCK TECHNOLOGY



Try our New Lever Camlock/Clip system redesigned to be 15% lighter. A unique internal release mechanism is engineered to eject belts clips quickly. Our belts clips are interchangeable with rotary camlock. These systems feature a sleek matte black finish.

**UPGRADE**  
Aluminum shoulder adjuster upgrade \$100.00

**FEATURE**  
Can be made with 2" upper shoulder Harness for Head Restraints

**COLORS**  
Black, Blue, Red, Platinum (\$10 additional charge for Platinum)



### Lever Camlock Technology

| CODE   | TYPE   | PRICE    |
|--------|--|----------|
| 29114  | FORMULA CAR 6-WAY PULL UP, RESTRAINT BOLT-IN         | \$279.95 |
| 29114P | UPGRADED TO PLATINUM SERIES                          | \$289.95 |
| 29102  | 62" FLOOR MOUNT SEAT BELT PULL UP, RESTRAINT BOLT-IN | \$249.95 |
| 29102P | UPGRADED TO PLATINUM SERIES                          | \$259.95 |
| 29104  | 62" SEAT BELT PULL UP, RESTRAINT BOLT-IN             | \$249.95 |
| 29104P | UPGRADED TO PLATINUM SERIES                          | \$259.95 |
| 29108  | 55" SEAT BELT PULL DOWN, ROLL BAR V HARNESS BOLT-IN  | \$249.95 |
| 29108P | UPGRADED TO PLATINUM SERIES                          | \$259.95 |
| 29110  | 55" SEAT BELT PULL DOWN, RESTRAINT BOLT-IN           | \$249.95 |
| 29110P | UPGRADED TO PLATINUM SERIES                          | \$259.95 |
| 29112  | 55" WRAP AROUND SEAT BELT, PULL DOWN RESTRAINT       | \$249.95 |
| 29112P | UPGRADED TO PLATINUM SERIES                          | \$259.95 |

29114P PLATINUM SERIES



29108



29110





## LATCH F/X



Compact integrated latch, link and adjuster reduces size by 30%. Drop-forged construction reduces weight by 30%. V-type or individual shoulder harnesses. Adjusters include anti-slip spring. No left side adjuster option available. Platinum Series also available.

### UPGRADE

Aluminum shoulder adjuster \$100.00

### FEATURE

Can be made with 2" upper shoulder harness for Head Restraints

### COLORS

Black, Blue, Red, Platinum (\$10 additional charge for Platinum)

### Latch F/X

| CODE   | TYPE   | PRICE    |
|--------|--|----------|
| 29072  | 62" WRAP AROUND SEAT BELT, PULL DOWN RESTRAINT WRAP AROUND | \$129.95 |
| 29072P | UPGRADED TO PLATINUM SERIES                                | \$139.95 |
| 29073  | 62" SEAT BELT PULL DOWN, RESTRAINT BOLT-IN                 | \$129.95 |
| 29073P | UPGRADED TO PLATINUM SERIES                                | \$139.95 |
| 29074  | 62" SEAT BELT PULL DOWN, ROLL BAR V HARNES BOLT-IN         | \$129.95 |
| 29074P | UPGRADED TO PLATINUM SERIES                                | \$139.95 |

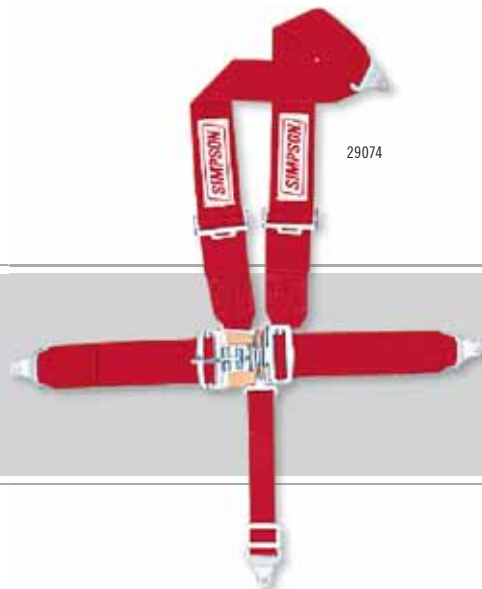

# HARNESSES, NETS AND DRAG CHUTES

## SPORT LATCH & LINK

Features polyester construction for maximum protection. Belts ship as a wrap around system. Separate bolt in brackets included in the box. Sport Model features the S-logo Simpson patch.

### COLORS

Black, Blue, Red



### Sport Latch & Link

| CODE  | TYPE                                 | PRICE    |
|-------|--------------------------------------|----------|
| 29043 | 55" BOLT-IN SPORT LATCH & LINK, 5-PT | \$109.95 |

## STD. LATCH & LINK

Drop-forged alloy steel with cadmium plating. Standard 3" military specification webbing on shoulder and lap belts with heat cut and sealed ends. Pull up or pull down adjusters. V-type or Individual shoulder harnesses. Adjusters include anti-slip springs. No left side adjuster option available. Floor-mount, bolt-in seat belts, or wrap around. Platinum Series also available.

### UPGRADE

Aluminum shoulder adjuster \$100.00

### FEATURE

Can be made with 2" upper shoulder harness for Head Restraints

### COLORS

Black, Blue, Red, Platinum (\$10 additional charge for Platinum)



29061



29063



29065



### STD. Latch & Link

| CODE   | TYPE  | PRICE    |
|--------|---|----------|
| 29061  | 62" SEAT BELT PULL UP RESTRAINT BOLT-IN                               | \$129.95 |
| 29061P | UPGRADED TO PLATINUM SERIES   | \$139.95 |
| 29063  | 55" SEAT BELT PULL DOWN, RESTRAINT BOLT-IN                            | \$129.95 |
| 29063P | UPGRADED TO PLATINUM SERIES   | \$139.95 |
| 29064  | 55" WRAP AROUND SEAT BELT PULL DOWN, RESTRAINT WRAP AROUND            | \$129.95 |
| 29064P | UPGRADED TO PLATINUM SERIES   | \$139.95 |
| 29065  | 55" SEAT BELT PULL DOWN, ROLL BAR V HARNESS BOLT-IN                   | \$129.95 |
| 29065P | UPGRADED TO PLATINUM SERIES   | \$139.95 |
| 29066  | SPRINT CAR BELT PULL DOWN, NO RIGHT SIDE ADJUSTER                     | \$129.95 |
| 29066P | UPGRADED TO PLATINUM SERIES   | \$139.95 |
| 29075  | SPRINT CAR BELT PULL DOWN, NO RIGHT SIDE ADJUSTER W/SHORT SEW PATTERN | \$129.95 |
| 29075P | UPGRADED TO PLATINUM SERIES   | \$139.95 |



## RATCHET HARNESSES



For when the ride is especially rough and you want to keep those harnesses tightened down. Ratchet Harnesses are available in left side or right side, with Aluminum or Steel adjusters. These harnesses from our Platinum Plus line are manufactured at Simpson's North Carolina facility. In other words, like all Simpson belts, they are made in the USA!



SB.51204

### Ratchet Harnesses

| CODE     | TYPE  | PRICE    |
|----------|---|----------|
| SB.51201 | 16.1 L&L W/ STEEL ADJUSTERS, RIGHT-SIDE RATCHET | \$329.95 |
| SB.51202 | 16.1 L&L W/ AL ADJUSTERS, RIGHT-SIDE RATCHET    | \$379.95 |
| SB.51203 | 16.1 L&L W/ STEEL ADJUSTERS, LEFT-SIDE RATCHET  | \$329.95 |
| SB.51204 | 16.1 L&L W/ AL ADJUSTERS, LEFT-SIDE RATCHET     | \$379.95 |



CALL FOR ADDITIONAL CONFIGURATIONS.

## JR. DRAGSTER



**COLORS**  
Black, Blue, Red



### Jr. Dragster

| CODE  | TYPE   | PRICE   |
|-------|--|---------|
| 35012 | WRAP AROUND SEAT BELT, PULL UP<br>ROLL BAR WRAP AROUND HARNESS | \$99.95 |

## QUARTER MIDGET



**COLORS**  
Black, Blue, Red



### Quarter Midget

| CODE  | TYPE   | PRICE   |
|-------|--|---------|
| 29025 | WRAP AROUND SEAT BELT, PULL DOWN<br>ROLL BAR WRAP AROUND HARNESS | \$99.95 |
| 29026 | BOLT-IN SEAT BELT, PULL DOWN<br>INDIVIDUAL HARNESS BOLT-IN       | \$99.95 |

# HARNESSES, NETS AND DRAG CHUTES

## 7 POINT DRAG CAMLOCK



Simpson Drag Restraints are SFI 16.1 Rated. Our belts are manufactured using polyester webbing for strength and durability. Bolt-in individual shoulder harness (18"). Lap belt has pull up adjustments on right and left side bolt-in. Formula style sub-belts with additional sub-belt to make 7th point. Nomex® covered.



### 7 Point Drag Camlock

| CODE    | TYPE                          | PRICE    |
|---------|-------------------------------|----------|
| 29115BK | FUNNY CAR RESTRAINT, BLACK    | \$289.95 |
| 29115P  | FUNNY CAR RESTRAINT, PLATINUM | \$299.95 |



29115BK

## 5 AND 7 POINT DRAG CAMLOCK



Drag Racing 5-way restraint covered with Nomex®

**COLORS**  
Black, Blue, Red and Platinum upgrade



29116

### 5 and 7 Point Drag Camlock

| CODE   | TYPE                                    | PRICE    |
|--------|---|----------|
| 29116  | 5-POINT RESTRAINT                       | \$279.95 |
| 29116P | 5-POINT RESTRAINT, PLATINUM             | \$289.95 |
| 29116M | 7-POINT RESTRAINT, SINGLE SHOULDER      | \$339.50 |
| 29110M | 7-POINT RESTRAINT, INDIVIDUAL SHOULDERS | \$339.50 |

## STERNUM BUCKLE

SHOULDER HARNESS  
SOLD SEPARATELY



| CODE:         | TYPE:    | PRICE:  |
|---------------|----------|---------|
| PSTERNUMSTRAP | OFF-ROAD | \$14.95 |



## SEATBELTS

### MOUNTING HARDWARE

Simpson offers 3 types of restraint mounting hardware: Bolt-in (left), Wrap Around (center), Floor Mount (right).



BOLT-IN



WRAP AROUND



FLOOR MOUNT

NOT SHOWN TO SCALE.  
FOR CONFIGURATION DEMONSTRATION ONLY.

| CODE  | TYPE                                | PRICE   |
|-------|-------------------------------------|---------|
| 31022 | BOLT-IN BRACKET, 2 EACH             | \$13.95 |
| 31019 | 3" BAR SLIDE ADJUSTERS, 2 EACH      | \$9.95  |
| 31020 | FLOOR MOUNTING KIT, 2 EACH          | \$19.95 |
| 31018 | EYE BOLT KIT, EYEBOLT, NUT & WASHER | \$12.95 |

### LATCH FX SEATBELT

#### PULL DOWN ADJUSTMENT



| CODE  | TYPE                               | PRICE   |
|-------|------------------------------------|---------|
| 29030 | 62" FLOOR MOUNT, ADJUSTMENT TO 36" | \$89.95 |
| 29032 | 62" WRAP AROUND, ADJUSTMENT TO 32" | \$89.95 |
| 29034 | 62" BOLT IN, ADJUSTMENT TO 32"     | \$89.95 |

COLORS: Black, Blue, Red, Platinum Series Upgrade Available

### LATCH AND LINK SEATBELT

#### PULL UP ADJUSTMENT



| CODE  | TYPE                               | PRICE   |
|-------|------------------------------------|---------|
| 29000 | 62" FLOOR MOUNT, ADJUSTMENT TO 36" | \$89.95 |
| 29002 | 62" WRAP AROUND, ADJUSTMENT TO 32" | \$89.95 |
| 29004 | 62" BOLT-IN, ADJUSTMENT TO 32"     | \$89.95 |

COLORS: Black, Blue, Red, Platinum Series Upgrade Available

#### PULL DOWN ADJUSTMENT



| CODE  | TYPE                           | PRICE   |
|-------|--------------------------------|---------|
| 29020 | 55" FLOOR MOUNT                | \$89.95 |
| 29022 | WRAP AROUND, ADJUSTMENT TO 24" | \$89.95 |
| 29024 | 55" BOLT-IN                    | \$89.95 |

COLORS: Black, Blue, Red, Platinum Series Upgrade Available

### CAMLOCK SEATBELT

#### PULL UP ADJUSTMENT



| CODE  | TYPE                           | PRICE    |
|-------|--------------------------------|----------|
| 32000 | 62" FLOOR MOUNT                | \$169.95 |
| 32002 | 62" WRAP AROUND                | \$169.95 |
| 32004 | 62" BOLT-IN, ADJUSTMENT TO 36" | \$169.95 |

COLORS: Black, Blue, Red, Platinum Series Upgrade Available

#### PULL DOWN ADJUSTMENT



| CODE  | TYPE            | PRICE    |
|-------|-----------------|----------|
| 32020 | 55" FLOOR MOUNT | \$169.95 |
| 32022 | 55" WRAP AROUND | \$169.95 |
| 32024 | 55" BOLT-IN     | \$169.95 |

COLORS: Black, Blue, Red, Platinum Series Upgrade Available



## HARNESSES AND ANTI-SUB BELTS

### DUAL ANTI-SUB BELTS

Semi-adjustable. Measures 27" per side. Bolt-in installation. Fits CamLock or Latch Type buckle.



| CODE  | TYPE       | PRICE   |
|-------|------------|---------|
| 34014 | CAMLOCK    | \$39.95 |
| 31014 | LATCH TYPE | \$39.95 |

COLORS: Black, Blue, Red, Platinum Series Upgrade Available

### ROLLBAR MOUNT

Compatible with SFI 38.1 Head and Neck restraint. 3" V-type shoulder harness attaches to any belt. V belt length from bolt-in mounting bracket to the buckle has adjustable length of 24 to 33 inches.



| CODE  | TYPE       | PRICE   |
|-------|------------|---------|
| 33005 | CAMLOCK    | \$59.95 |
| 30005 | LATCH TYPE | \$59.95 |

COLORS: Black, Blue, Red, Platinum Series Upgrade Available

### ANTI-SUBMARINE BELTS



| CODE  | TYPE                 | PRICE   |
|-------|----------------------|---------|
| 34012 | CAMLOCK BOLT-IN      | \$29.95 |
| 31012 | LATCH TYPE BOLT-IN   | \$29.95 |
| 34013 | CAMLOCK FLOOR MT.    | \$34.95 |
| 31013 | LATCH TYPE FLOOR MT. | \$34.95 |

COLORS: Black, Blue, Red, Platinum Series Upgrade Available

Semi-adjustable  
27" long  
Adjustable Pull-up  
Bolt-in mounting



| CODE  | TYPE       | PRICE   |
|-------|------------|---------|
| 34015 | CAMLOCK    | \$29.95 |
| 31015 | LATCH TYPE | \$29.95 |

COLORS: Black, Blue, Red, Platinum Series Upgrade Available

### STERNUM BUCKLE

Holds shoulder harness together. For CamLock or standard Latch & Link seat belts. NOT SOLD SEPARATELY. Can only be added at time of belt purchase. Order harness part number and add Sternum Protector.



| CODE          | PRICE   |
|---------------|---------|
| PSTERNUMSTRAP | \$14.95 |

### SHOULDER HARNESS HEAD & NECK RESTRAINT COMPATIBLE

Compatible with SFI 38.1 Head and Neck restraint. Individual shoulder harnesses. 48" length adjusts down to 24". Shoulder harness 2" (shown).



| CODE  | TYPE       | PRICE   |
|-------|------------|---------|
| 33010 | CAMLOCK    | \$59.95 |
| 30010 | LATCH TYPE | \$59.95 |

COLORS: Black, Blue, Red, Platinum Series Upgrade Available

### HEAD AND NECK RESTRAINT DUAL HARNESS

| CODE  | TYPE                           | PRICE   |
|-------|--------------------------------|---------|
| 33011 | CAMLOCK DUAL                   | \$99.95 |
| 30011 | LATCH & LINK, DUAL WRAP AROUND | \$99.95 |

COLORS: Black, Blue, Red, Platinum Series Upgrade Available

### SHOULDER HARNESS

Individual shoulder harnesses. 48" long and adjust down to 24". Bolt-in or wrap around style.



| CODE  | TYPE               | PRICE   |
|-------|--------------------|---------|
| 33004 | CAMLOCK            | \$59.95 |
| 30004 | LATCH TYPE BOLT-IN | \$59.95 |

COLORS: Black, Blue, Red, Platinum Series Upgrade Available

### FLOOR MOUNT INDIVIDUAL HARNESS 75" (Not Shown)

| CODE  | TYPE       | PRICE   |
|-------|------------|---------|
| 33009 | CAMLOCK    | \$89.95 |
| 30009 | LATCH TYPE | \$89.95 |

COLORS: Black, Blue, Red, Platinum Series Upgrade Available



## TIE DOWNS AND RESTRAINTS

### HELMET RESTRAINTS

Fatigue-reducing helmet strap  
Quick attachment and adjustment  
Durable steel hardware, helmet  
"D-ring" installation



|              |                         |                |
|--------------|-------------------------|----------------|
| CODE         | TYPE                    | PRICE          |
| <b>36007</b> | <b>HELMET RESTRAINT</b> | <b>\$14.95</b> |

COLORS: Black, Blue, Red

### RATCHET TIEDOWNS

High-strength ratchet tie-downs secure racing vehicle to trailer or transporter  
2" polyester webbing featuring a ratcheting buckle with integral hook and snap hook  
at opposite end  
Convenient and easy to use, these tie-downs go on and off with a few flicks of the wrist  
Sold in pairs, each piece 8' long



|              |                                |                |
|--------------|--------------------------------|----------------|
| CODE         | TYPE                           | PRICE          |
| <b>35007</b> | <b>RATCHET TIE DOWN (PAIR)</b> | <b>\$59.95</b> |

COLORS: Black, Blue, Red

### ROLLBAR PADDING

Open Cell Urethane padding comes in 36" sections  
"C" shaped to fit 1 5/8" to 2" tubing  
WILL NOT DRIP OR MELT  
Meets SFI 45.1  
Impact test proven effective



|              |                                     |                |
|--------------|-------------------------------------|----------------|
| CODE         | TYPE                                | PRICE          |
| <b>36008</b> | <b>SFI 45.1 EMBOSSED IN PADDING</b> | <b>\$34.95</b> |

COLOR: Black

### SHIFT BOOT COVER

Simpson leads the way in racing safety once again with our reinforced shift boot cover,  
equipped with an innovative top seal Kevlar strap and D-Ring fastener designed to  
control the spread of a fire from underneath the car into the cockpit area.

SFI 48.1 approved  
Made with Nomex®  
Reverse Stitching Nomex® thread seam  
Kevlar interior for added protection  
Base: 7.25" x 6.25"



|              |                         |                |
|--------------|-------------------------|----------------|
| CODE         | TYPE                    | PRICE          |
| <b>36012</b> | <b>SHIFT BOOT COVER</b> | <b>\$79.95</b> |

Color: Black only

### NOMEX® HARNES PADS

Attaches with speedfit to shoulder harness or lap belt  
Tighten down your belts in comfort



|               |                           |                |
|---------------|---------------------------|----------------|
| CODE          | TYPE                      | PRICE          |
| <b>230210</b> | <b>HARNES PADS (PAIR)</b> | <b>\$49.95</b> |

COLORS: Black, Blue, Red

### AXLE RATCHET TIE DOWN W/D-RING

8' long tie down provides additional security via axle or rear-end  
2" polyester webbing features a ratcheting buckle with integral hook and sail hook  
that fastens into a D-ring  
Sold individually



|              |                                     |                |
|--------------|-------------------------------------|----------------|
| CODE         | TYPE                                | PRICE          |
| <b>35009</b> | <b>AXLE RATCHET TIE DOWN (EACH)</b> | <b>\$39.95</b> |

COLORS: Black, Blue, Red

### AXLE STRAPS

Ties down racing vehicle via axle or wrap around the frame  
24" long with 2" webbing  
D-rings on both ends



|              |                             |                |
|--------------|-----------------------------|----------------|
| CODE         | TYPE                        | PRICE          |
| <b>35010</b> | <b>AXLE STRAP (EACH)</b>    | <b>\$19.95</b> |
| <b>35008</b> | <b>15' TOW STRAP (EACH)</b> | <b>\$34.95</b> |
| <b>35011</b> | <b>LIMITER STRAP (EACH)</b> | <b>\$39.95</b> |

COLORS: Black, Blue, Red

### ARM RESTRAINTS

Meets SFI 3.3.  
A must for Sprint, Midget  
and Off-Road racing.  
Features padded arm bands  
and steel hardware.  
Easy release allows quick entry and exit from driver's compartment.



|              |   |                |
|--------------|---|----------------|
| CODE         | TYPE  | PRICE          |
| <b>36000</b> | <b>ARM RESTRAINT W/ INDIVIDUAL STRAPS</b>   | <b>\$39.95</b> |
| <b>36001</b> | <b>ARM RESTRAINTS W/Y STRAPS</b>  | <b>\$44.95</b> |
| <b>J3600</b> | <b>JR. ARM RESTRAINT W/ INDIVIDUAL STRAPS<br/>AVAILABLE WITH "Y" STRAPS AS CUSTOM ORDER</b> | <b>\$34.95</b> |

COLORS: Black, Blue, Red

|               |   |                |
|---------------|---|----------------|
| <b>54018</b>  | <b>INDIVIDUAL REPLACEMENT STRAPS<br/>FOR BUILT-IN ARM RESTRAINT</b> | <b>\$9.95</b>  |
| <b>AR.QTM</b> | <b>JR. ARM RESTRAINTS (VELCRO)</b>                                  | <b>\$36.00</b> |
| <b>AR.ADU</b> | <b>ADULT ARM RESTRAINTS (VELCRO), BLACK ONLY</b>                    | <b>\$45.00</b> |



## NETS AND ACCESSORIES

### LEFT SIDE MOUNT CAGE NET

SFI 37.1 approved. Webbing tensile strength is 6,000 lbs. Fits up to 58" between "A" post and roll cage behind seat. Wraps around seat to support Head rest and shoulder. Helps keep driver in proper position and provides extra barrier behind window net.



|              |                        |                |
|--------------|------------------------|----------------|
| CODE         | TYPE                   | PRICE          |
| <b>36016</b> | <b>LEFT SIDE MOUNT</b> | <b>\$99.95</b> |

COLOR: Black

### RIGHT SIDE MOUNT CAGE NET

SFI 37.1 approved. Webbing tensile strength is 6,000 lbs. Fits up to 58" between dash bar and roll cage behind seat. Wraps around seat to support Head rest and shoulder. Helps keep driver in proper position during crash.



|              |                         |                |
|--------------|-------------------------|----------------|
| CODE         | TYPE                    | PRICE          |
| <b>36015</b> | <b>RIGHT SIDE MOUNT</b> | <b>\$99.95</b> |

COLOR: Platinum

### SPRINT/MIDGET NET

Meets SFI 37.1. Window nets for Sprints, Midgets and Quarter Midgets. 1" webbing with quick release buckle.



|               |                       |                |
|---------------|-----------------------|----------------|
| CODE          | TYPE                  | PRICE          |
| <b>36005</b>  | <b>SPRINT</b>         | <b>\$99.95</b> |
| <b>J36005</b> | <b>QUARTER MIDGET</b> | <b>\$99.95</b> |
| <b>36006</b>  | <b>CHAMP CAR</b>      | <b>\$99.95</b> |

COLORS: Black, Blue, Red

### C5R DRIVER NET

Our original red handle nets adapt to all makes and models of race cars. SFI 37.1 Approved. Available in Kevlar or Polyester. Quick Release Design. The CR5s special design keeps it out of the field of vision while providing side and angular impact protection.



|                  |                          |                 |
|------------------|--------------------------|-----------------|
| CODE             | TYPE                     | PRICE           |
| <b>DN.C5R.RK</b> | <b>RIGHT SIDE KEVLAR</b> | <b>\$169.95</b> |
| <b>DN.C5R.LK</b> | <b>LEFT SIDE KEVLAR</b>  | <b>\$169.95</b> |
| <b>DN.C5R.RP</b> | <b>RIGHT SIDE POLY</b>   | <b>\$129.95</b> |
| <b>DN.C5R.LP</b> | <b>LEFT SIDE POLY</b>    | <b>\$129.95</b> |

### GRAND AM KEVLAR NET



|                  |                          |                 |
|------------------|--------------------------|-----------------|
| CODE             | TYPE                     | PRICE           |
| <b>DN.GRD.RK</b> | <b>RIGHT SIDE KEVLAR</b> | <b>\$169.95</b> |
| <b>DN.GRD.LK</b> | <b>LEFT SIDE KEVLAR</b>  | <b>\$169.95</b> |

### SPRINT CAR NET



|                  |                          |                 |
|------------------|--------------------------|-----------------|
| CODE             | TYPE                     | PRICE           |
| <b>DN.SPR.RK</b> | <b>RIGHT SIDE KEVLAR</b> | <b>\$169.95</b> |
| <b>DN.SPR.LK</b> | <b>LEFT SIDE KEVLAR</b>  | <b>\$169.95</b> |
| <b>DN.SPR.RP</b> | <b>RIGHT SIDE POLY</b>   | <b>\$129.95</b> |
| <b>DN.SPR.LP</b> | <b>LEFT SIDE POLY</b>    | <b>\$129.95</b> |





## NETS AND ACCESSORIES

### KART BRACE

Dual foam layers provide a protective inner core with a comfortable outer shell and an abrasion-resistant fabric lining. Rigid SFI 45.2 impact rated foam reduces neck flexion and head rotation during impact.



| CODE                 | TYPE                                  | PRICE          |
|----------------------|---------------------------------------|----------------|
| <b>KARTBRACE. LW</b> | <b>ADULT AND YOUTH SIZE AVAILABLE</b> | <b>\$99.95</b> |

COLOR: Black

### PADDED NECK SUPPORT

SFI tag included, SFI 3.3 approved. Reduces Neck fatigue for any racer. Removable knit Nomex® sleeve. One size with adjustable speedfit fasteners (*can be custom fit*).



| CODE         | TYPE         | PRICE          |
|--------------|--------------|----------------|
| <b>23022</b> | <b>RED</b>   | <b>\$29.95</b> |
| <b>23022</b> | <b>BLUE</b>  | <b>\$29.95</b> |
| <b>23022</b> | <b>BLACK</b> | <b>\$39.95</b> |

COLORS: Black, Blue, Red

### PADDED NECK COLLAR

Head and Neck restraint compatible.  
SFI 45.2 Padding



| CODE              | PRICE          |
|-------------------|----------------|
| <b>NC.CHD.YTH</b> | <b>\$99.95</b> |
| <b>NC.SML</b>     | <b>\$99.95</b> |
| <b>NC.MED</b>     | <b>\$99.95</b> |
| <b>NC.LRG</b>     | <b>\$99.95</b> |

COLOR: Black

### WINDOW NET

Standard, NASCAR or Custom  
Meets SFI 27.1. Stock Car type and square window nets for full-bodied cars.  
Stock Car type is 16" x 27" trapezoid with 1" webbing.

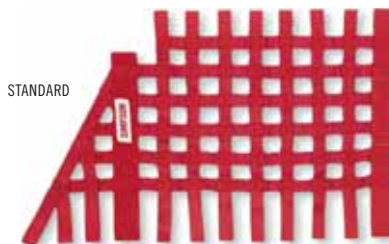

| CODE         | TYPE                            | PRICE                       |
|--------------|---------------------------------|-----------------------------|
| <b>36002</b> | <b>18" X 24" RECTANGLE</b>      | <b>\$99.95</b>              |
| <b>36003</b> | <b>24" X 24" SQUARE</b>         | <b>\$99.95</b>              |
| <b>36004</b> | <b>16" X 27" TRAPEZOID</b>      | <b>\$99.95</b>              |
| <b>36013</b> | <b>CUSTOM NET SEND TEMPLATE</b> | <b>STARTING AT \$129.95</b> |

CALL FOR QUOTE

COLORS: Black, Blue, Red

NASCAR,  
OFFERED IN BLACK ONLY



| CODE          | TYPE                          | PRICE           |
|---------------|-------------------------------|-----------------|
| <b>NASCAR</b> | <b>NASCAR NET, BLACK ONLY</b> | <b>\$249.95</b> |

### CHIN STRAPS



| CODE          | TYPE                         | PRICE           |
|---------------|------------------------------|-----------------|
| <b>RH.DCS</b> | <b>DOUBLE CHIN STRAP "W"</b> | <b>\$139.00</b> |
| <b>DRC.SS</b> | <b>SINGLE CHIN STRAP</b>     | <b>\$39.00</b>  |
| <b>DRC.CS</b> | <b>CENTERING CHIN STRAP</b>  | <b>\$49.00</b>  |

### OFF-ROAD NECK COLLAR

WITH OR  
WITHOUT FLANGE



| CODE          | TYPE                                | PRICE           |
|---------------|-------------------------------------|-----------------|
| <b>NC.OR</b>  | <b>OFF-ROAD</b>                     | <b>\$129.95</b> |
| <b>NC.ORF</b> | <b>OFF ROAD W/FLANGE (AS SHOWN)</b> | <b>\$129.95</b> |

# HARNESSES, NETS AND DRAG CHUTES

## 12' CROSSFORM DRAG CHUTE



Designed for Funny Cars and Dragsters. Handmade Crossform design for outstanding performance from 200 to 300+ mph. Complete with aluminized pack and pilot chute.

### COLORS

Black, Blue, Red, Golden Yellow



|                       |                                      |                           |
|-----------------------|--------------------------------------|---------------------------|
| CODE:<br><b>42060</b> | TYPE:<br><b>CROSSFORM DRAG CHUTE</b> | PRICE:<br><b>\$569.95</b> |
|-----------------------|--------------------------------------|---------------------------|

CALL FOR QUOTE TO ADD CUSTOM LETTERS AND/OR LOGO.

## 10' SKY JACKER DRAG CHUTE



Handmade Crossform design delivers reliable and durable performance for all cars up to 200 mph. Complete with black nylon pack and pilot chute.

### COLORS

Black, Blue, Red, Golden Yellow. Custom colors available.



|                       |                                       |                           |
|-----------------------|---------------------------------------|---------------------------|
| CODE:<br><b>42020</b> | TYPE:<br><b>SKY JACKER DRAG CHUTE</b> | PRICE:<br><b>\$459.95</b> |
|-----------------------|---------------------------------------|---------------------------|

CALL FOR QUOTE TO ADD CUSTOM LETTERS AND/OR LOGO.

## 14' PROFESSIONAL SERIES



Our largest 14' parachute canopy. All Kevlar chute and shroud line construction. 20% lighter than traditional nylon chute. Kevlar translates to increased speed and a safer racing environment. Increased fire protection. Handmade in the USA, cross form design for top performance at speeds of 300+ mph. Ships complete with pack and pilot chute.



### 14' Professional Series

| CODE  | TYPE   | PRICE      |
|-------|--|------------|
| 42055 | 14' KEVLAR CHUTE WITH KEVLAR® SHROUD LINES<br><i>Color: Yellow Only</i>                                | \$1,699.95 |
| 42050 | 14' PREMIUM NYLON CHUTE WITH KEVLAR® SHROUD LINES<br><i>Colors: Black, Blue, Red and Golden Yellow</i> | \$899.95   |

CALL FOR QUOTE TO ADD CUSTOM LETTERS AND/OR LOGO.

Kevlar® Parachutes are 20% Lighter

## 8 FT. OUTLAW SKY JACKER DRAG CHUTE



Made in the USA. 4 Lightweight Kevlar Shroud Lines make the Outlaw chute the number 1 choice for drag racers looking to reduce their weight load. Professional series stopping power, quality construction. Handmade crossform chute delivers reliable performance for cars up to 200 mph. Ships with pack and pilot chute.



### COLORS

Black, Red, Blue, Golden Yellow

### 8 ft. Outlaw Sky Jacker Drag Chute

| CODE  | TYPE  | PRICE    |
|-------|---|----------|
| 42038 | 8' DRAG CHUTE FEATURING KEVLAR SHROUD LINE CONSTRUCTION | \$659.95 |

CALL FOR QUOTE TO ADD CUSTOM LETTERS AND/OR LOGO.

## AIR BOSS PARACHUTE 10 FT.



### COLORS

Black, Blue, Red, Golden Yellow



### FEATURES

Pneumatic Launcher Style  
Designed for applications where a launcher style chute is necessary  
Canopy Size: Order 8' or 10' chute  
Four Kevlar lines for added protection  
Chutes manufactured in the USA  
Quality craftsmanship  
Team and Sponsor logos can be added (*call for pricing*)  
Simpson race day service and support still going strong

### Air Boss Parachute 10 Ft.

| CODE  | TYPE                                  | PRICE      |
|-------|---------------------------------------|------------|
| 42040 | 10' CHUTE                             | \$659.00   |
| 42041 | 10' CHUTE/LAUNCHER                    | \$949.00   |
| 42042 | 10' DUAL AIR BOSS, CHUTE/LAUNCHER     | \$1,799.00 |
| 42043 | 10' LAUNCHER SYSTEM                   | \$349.00   |
| 42044 | 10' DUAL LAUNCHER SYSTEM              | \$629.00   |
| 42045 | BLACK NOMEX® CHUTE PACK, 10' AIR BOSS | \$99.00    |
| 42046 | BLACK PILOT BAG, 10' AIR BOSS         | \$99.00    |

## AIR BOSS PARACHUTE 8 FT.

### Air Boss Parachute 8 Ft.

| CODE  | TYPE                                | PRICE      |
|-------|-------------------------------------|------------|
| 42030 | 8' CHUTE                            | \$599.00   |
| 42031 | 8' CHUTE / LAUNCHER                 | \$889.00   |
| 42032 | 8' DUAL AIR BOSS, CHUTE / LAUNCHER  | \$1,699.00 |
| 42033 | 8' LAUNCHER SYSTEM                  | \$319.00   |
| 42034 | 8' DUAL LAUNCHER SYSTEM             | \$619.00   |
| 42035 | BLACK NYLON CHUTE PACK, 8' AIR BOSS | \$89.00    |
| 42036 | BLACK PILOT BAG, 8' AIR BOSS        | \$99.00    |

## MINI DRAGSTER PARACHUTE AND CHUTE ACCESSORIES (NOT SHOWN)



## CHUTE FLAG TWO SIDED

| CODE:     | PRICE:  |
|-----------|---------|
| CHUTEFLAG | \$19.95 |

Simpson Branded. Two Sided Chute Flag. Simpson Red.

### Mini Dragster Parachute and Chute Accessories

| CODE  | TYPE                     | PRICE    |
|-------|--------------------------|----------|
| 42082 | MINI DRAGSTER CHUTE      | \$169.95 |
| 42085 | PILOT CHUTE (ALL MODELS) | \$99.95  |
| 42087 | CROSSFORM PACK           | \$134.95 |
| 42086 | SKY JACKER PACK          | \$99.95  |

## NEW AVIATION HARNESSES



Shop our range of aviation harnesses at [simpsonflight.com](http://simpsonflight.com)

Simpson Performance Products manufactures 5, 6 and 7-point aviation harnesses for experimental planes, aerobatic planes and historical/military restoration planes. We offer our most popular configurations along with fully customized harnesses stylized to the owner's specifications. Simpson aviation harnesses are made in the USA and backed by Simpson's 60 years of experience and research in motorsports safety.

Studies of serious accidents have shown that the proper use of shoulder harnesses, in addition to the safety belt, can reduce major injuries by 88 percent, and fatalities by 20 percent.

Simpson's own research shows us that the use of a 5, 6 or 7-point harness can have a major impact on occupant safety. After a number of auto racing fatalities in the 90s, Simpson Engineering went to the labs and established a library of proven practices that save lives.



7 POINT SOLUTIONS

6 POINT SOLUTIONS

### SIMPSON RESTRAINT PHILOSOPHY

1. Restraining the pelvis reduces torso and head injury numbers.
2. For optimum restraint, use 5, 6 or 7-point harnesses, no 4-point systems. Use quick-release camlock systems. Do not use retractors.
3. All Simpson restraint systems use Polyester webbing over Nylon for superior performance in stretch and longevity.
4. Apply data for a significantly higher performance rating.

# STREET CRED

## NOW AVAILABLE IN MULTIPLE SIZES

APPAREL AND GEAR

# APPAREL AND GEAR

## BAGS

### NEW STILO BACKPACK / ZAINETTO

CODE:  
YA0017S

SIZE:  
18" L X 16" W X 8" D

PRICE:  
\$79.95



**SUPER SPEEDWAY  
ROLLER BAG**

CODE:  
23303

SIZE:  
33.5" L X 18" W X 16.5" H

PRICE:  
\$199.95



**SPEEDWAY  
BAG**

CODE:  
23301

SIZE:  
27" L X 13" W X 17" H

PRICE:  
\$89.95

**RACING SUIT  
TOTE BAG**



CODE:  
23306

PRICE:  
\$19.95

**RACEWAY  
BAG**



CODE:  
23304

SIZE:  
20" L X 11" W X 13" H

PRICE:  
\$54.95



**PIT PACK**

CODE:  
23307

SIZE:  
18" L X 13" W X 10" D

PRICE:  
\$59.95



**PLUSH  
HELMET BAG**

CODE:  
23305

PRICE:  
\$34.95

## SIMPSON BRANDED APPAREL FOR 2019

Whether it is a cool night at Chili Bowl, cruising the midway at Indy Nationals, a memorable trip to the Daytona 500 or tuning your race car at home, Simpson apparel is designed to come along for the ride. Visit our website at [simpsonperformance.com](http://simpsonperformance.com) throughout the year for updated styles and availability.



### 59 HOODIE RED

| CODE: | SIZE:   | COLOR: | PRICE:  |
|-------|---------|--------|---------|
| 44904 | S - XXL | RED    | \$39.99 |



### CLASSIC HOODIE

| CODE: | SIZE:   | COLOR: | PRICE:  |
|-------|---------|--------|---------|
| 44008 | S - XXL | BLACK  | \$39.99 |

## ALL-TERRAIN JACKET

Weather-resistant outer with warm fleece inner. A lightweight jacket that helps to keep you warm and dry.



| CODE: | SIZE:   | COLOR:                 | PRICE:  |
|-------|---------|------------------------|---------|
| 43094 | S - XXL | BLACK WITH WHITE LOGOS | \$99.99 |



## HATS

### DNA PERFORMANCE HAT



#### DNA Performance Hat

| CODE   | SIZE | COLOR      | PRICE   |
|--------|------|------------|---------|
| 430741 | S/M  | BLACK/GREY | \$24.99 |
| 430742 | L/XL | BLACK/GREY | \$24.99 |
| 430731 | S/M  | BLACK/RED  | \$24.99 |
| 430732 | M/XL | BLACK/RED  | \$24.99 |



### SIMPSON TEAM HAT

| CODE: | SIZE:     | COLOR:    | PRICE:  |
|-------|-----------|-----------|---------|
| 44010 | S/M, L/XL | BLACK/RED | \$19.99 |

### LOW PROFILE 60<sup>TH</sup> ANNIVERSARY VINTAGE HAT



| CODE:  | SIZE:               | COLOR: | PRICE:  |
|--------|---------------------|--------|---------|
| 449101 | ONE SIZE ADJUSTABLE | RED    | \$19.99 |



### VINTAGE HAT

| CODE:  | SIZE:                | COLOR:             | PRICE:  |
|--------|----------------------|--------------------|---------|
| 440193 | SNAP BACK ADJUSTABLE | BLACK/MULTI STRIPE | \$19.99 |



## TEES

### 60TH ANNIVERSARY SPECIAL EDITION TEES

CODE: 44901    SIZE: S - XXL    PRICE: \$19.99

Colors: White, Black, Red



FRONT

FRONT

FRONT

### USA FLAG TEE

CODE: 44018    SIZE: S - XXL    PRICE: \$19.99

Color: Black



BACK

FRONT

### LOGO TEE

CODE: 44903    SIZE: S - XXXL    PRICE: \$19.99

Color: Black



FRONT

### LADIES TEE

CODE: 44020    SIZE: XS - 2XL    PRICE: \$24.95

Color: Black



FRONT

BACK

### CHAMPION TEE

CODE: 44902    SIZE: S - XXXL    PRICE: \$19.99

Color: Black



FRONT

### NEW STILO TEE

CODE: YY0022    SIZE: S - XXL    PRICE: \$19.99

Color: Grey

Check website for additional styles



BACK

FRONT

### VINTAGE TEE

CODE: 44006    SIZE: S - XXL    PRICE: \$19.99

Color: Black



FRONT



## WE WANT TO HEAR FROM YOU.

Post photos of yourselves in your Simpson gear using [#simpsonracing](#) or [#simpsonhelmets](#), and tell us about your life in racing and why you get behind the wheel with Simpson.

### ORDER TOLL-FREE

Our sales team is ready to take your order or provide any assistance you may require by toll-free phone, mail or fax.

**1-800-654-7223 + FAX: 1-830-625-3269**

### CUSTOM SUITS AND CREW UNIFORMS

If you need assistance or help in ordering custom suits and/or crew uniforms, call our Tech Information and Help Line first. They will explain the different styles of suits, options, sizing, embroidery and anything else you might need to know.

**1-888-872-SUIT (7848) + FAX: 1-310-320-7179**

### TECHNICAL SUPPORT AND HELP LINE

If you have a question about a product or would like to check on an order, please call our toll-free Technical Support line between 8 AM – 5 PM, Monday through Friday, Central Time. Or, use the toll-free **1-888-872-SUIT (7848)** between 8 AM – 5 PM, Monday through Friday, Pacific Time for assistance regarding Custom Suits & Crew Uniforms.

**1-800-654-RACE (7223) or 1-888-872-SUIT (7848)**

*(Custom Suits & Crew Uniforms)*

### RETURNS

Simpson warrants all product materials and workmanship when used according to the manufacturer's instructions. Warranty does not include damage to the product as a result of misuse, abuse of the product, or normal wear and tear. Simpson will provide a replacement part or product at its sole discretion. Purchaser must assume responsibility for the cost of shipping the product to Simpson for service or inspection. Should any product not meet your expectations for fit, workmanship and quality, please call **1-800-654-7223**. If you need to return a custom crew suit or crew uniform, please send to the following address:

**Simpson Performance Products**  
1407 West 240th Street, Harbor City, CA 90710

**NO REFUNDS ON MADE-TO-ORDER SUITS.**

### PRODUCT SERVICES AND RETURNS

If for any reason you would like to return a product you purchased or have a product you need serviced or inspected, ship it to Simpson via insured Parcel Post or UPS within 30 days. Please return new products in original condition, in the same boxes with a copy of the invoice to the following address:

**Simpson Performance Products**  
328 FM 306, New Braunfels, TX 78130

#### NATIONAL SALES

Corporate Headquarters  
328 FM 306  
New Braunfels, TX 78130  
TOLL-FREE 800-654-RACE (7223)  
PHONE 830-625-1774  
FAX 830-625-3269  
texasales@teamsimpson.com

**Newest Simpson World Store On-site**

#### FIRESUIT SALES

1407 West 240th Street  
Harbor City, CA 90710  
TOLL-FREE 888-872-SUIT (7848)  
PHONE 310-325-6035  
FAX 310-320-7179  
californiasales@teamsimpson.com

#### WEST COAST

Simpson World Store  
1405 West 240th Street  
Harbor City, CA 90710  
TOLL-FREE 800-929-7223  
PHONE 310-539-2266  
FAX 310-325-7967  
californiaretail@teamsimpson.com

#### EAST COAST

Simpson World Store  
185 Rolling Hills Road  
 Mooresville, NC 28117  
TOLL-FREE 800-473-7077  
PHONE 704-662-3366  
FAX 704-662-3360  
mooreville@teamsimpson.com

#### MIDWEST

Simpson World Indy  
486 Southpoint Circle Suite #105  
Brownsburg, IN 46112  
PHONE 317-858-3100  
FAX 317-858-6351  
indy@teamsimpson.com

### WARNING / DISCLAIMER

Motorsports are dangerous. No warranty or representations made as to product's ability to protect the user from any injury or death. The user assumes risk. It is the user's responsibility to become familiar with all available information concerning the correct use and limitations of these products. If you are uncertain of the correct use or limitations of this product, DO NOT USE IT. For more information call 1.800.654.7223.

By use of this product, the user acknowledges: That personal safety products are only part of a complete safety system that includes the vehicle, the race track, and the prevailing conditions at time of use. That personal safety products are not designed to provide the same level of performance or protection throughout the particular product. Different parts or areas of the product may provide less protection even though they may appear the same.

The user acknowledges that motorsports are dangerous. There is a serious risk of injury or death, even if this product is used correctly. No personal safety product can protect the user from injury or death.

© 2017 SIMPSON PERFORMANCE PRODUCTS



**SIMPSON**