

C A T
A L O
G U E
2019



PAOLI PIT STOP SERIES



paoli

COMPANY

Dino Paoli S.r.l. supplies all the teams participating in F1, F2, DTM, World Series by Renault, V8-Supercar, Indy Lights, IRL, Nascar, F. Nippon, and almost all racing teams in Endurance, GT, F.3000, IMSA.

Dino Paoli, the strength of a winning idea embodied in a company working in different sectors: motorsport, automotive, and industry.

A craft industry vocation and a long-standing tradition in the production of pneumatic impact wrenches and accessories have led the company to lead the Motorsport sector, making it the ideal partner for several teams, thanks to the high speed and reliability of its products.

Wheel guns to suit all the needs of those who believe in speed, making the pit stop a fundamental element in the outcome of a race.

Quality, technology, innovation and close collaboration with customers are just some of the features that have made Dino Paoli a successful name in the racing world.

THE WORLD CLASS IMPACT WRENCHES MANUFACTURING COMPANY



HISTORY

1975

F1 PODIUM

Thanks to the superior fastness and compactness of its products, Paoli becomes the official supplier for one of the most famous F1 teams.

2000

BRAND
AWARENESS

Paoli becomes synonym of race wheel gun.

2012

TSA SYSTEM

Dino Paoli S.r.l. introduces an innovative technology which is able to monitor the torque and angle signal on the wheel nut.

2016

DP6000

Paoli produces the DP 6000. The use of high quality materials and the revolutionary 90° ergonomics handle make the latest Paoli wheel gun a technology gem.

2018

NASCAR

Dino Paoli S.r.l., thanks to the development of new mechatronic technologies, becomes the official pit equipment supplier of Nascar.

1968

THE ORIGINS

Dino Paoli S.r.l. was incorporated in 1968 and it has specialized in the production of wheel guns used in workshops for commercial vehicles and standard road cars.

1994

THE US
MARKET

Dino Paoli S.r.l. enters for the first time the highly competitive US motorsport market.

2011

FORMULA
NASCAR

Dino Paoli S.r.l. gets into Nascar with Red Devil. This represents Paoli's debut in the one of the most important U.S. championships.

2014

DP5000 TI
MARK II

Paoli starts manufacturing new wheel guns using aerospace materials. Titanium, carbon and magnesium alloy are now used to produce the model DP5000 TI MARK II.

2017

RED DEVIL 2.0

Designed for Nascar, the RED DEVIL 2.0 has been developed in order to give an extraordinary fastness and smoothness to the Nascar tire changers.

DEVELOPMENT

400.000 IMPACT WRENCHES
SINCE 1968



100% F1 TEAMS
USE PAOLI GUNS



10% TURNOVER
REINVESTED IN TECHNOLOGY



700 RESELLERS
IN THE WORLD



40 AVERAGE AGE
OF PAOLI EMPLOYEES



5.000 HOURS
OF TRAINING



25 PATENTS
12 PATENT PENDINGS



FORMULA 1 100%

IMSA 80%

FORMULA 2 100%

ENDURANCE 100%

ELMS 100%

SUPER GT 99%

BLANCPAIN 100%

N1 SUPER TAIKYU 50%

24H LE MANS 100%

V8 SUPERCAR 50%

SUPER FORMULA 100%

INDYCAR 100%

GT 100%

NASCAR 100%

OTHERS 50%

WHAT'S NEW



W

WHEEL GUNS

18 DP 6000 Bias

S

PAOLI SOCKETS

56 Wheel Nut Sockets

R

FAST REVERSE DEVICES

72 E-Shuttle

O

WHEEL GUN OPTIONALS

85 Grip Tapes

A

AIR SUPPLY SYSTEM

111 Digital Gauges



INDEX



W

WHEEL GUNS

The unique wheel guns in motorsport races

8

A

AIR SUPPLY SYSTEM

Equipment for the maximum power

86

M

MOTORCYCLE SPORT

Paoli's motorbikes pit stop selection

46

E

PIT EQUIPMENT

All you need for the pitlane

126

S

PAOLI SOCKETS

The new Paoli wheel nut sockets

55

C

PRODUCT CARE

Service and overhaul

149

R

FAST REVERSE DEVICES

Speed up your wheel gun direction-change

70

F

FAQ

Your questions. Our answers

161

O

WHEEL GUN OPTIONALS

Enhance your Paoli guns

77

P

AUTOMOTIVE PRODUCTS

Discover Paoli automotive products
(lower pressure - 6,3 bar)

164





WHEEL GUNS

The unique wheel guns in motorsport races



HURRICANE CLASSIC HANDLE

BEST PRACTICE

FORMULA 1 / INDYCAR / FORMULA 2
DTM / ENDURANCE

Product name	HURRICANE CLASSIC HANDLE		
Front Cover Type	CARBON COVER		
Product code LH Version	HURRICANE.022		HURRICANE.019
Product code RH Version	2 port HURRICANE.023	3 port	HURRICANE.020
Product code UH Version	HURRICANE.024		HURRICANE.021
Square drive	1"		
Weight	3,70 kg (8.15 lbs)		
Length	203 mm (7.99")		
Air inlet	3/8" BSP		
Supply hose inside diameter	13 mm (0.51")		
Max pressure	25 bar (362 psi)		
Free Speed (25 bar / 362 psi)	LH / RH 15000 rpm UH 14800 rpm		
Max torque	LH / RH 4300 Nm (3172 ft-lbs) UH 4200 Nm (3100 ft-lbs)		

ALSO AVAILABLE

Product name	HURRICANE CLASSIC HANDLE		
Front Cover Type	AEROSPACE 7075 ALUMINIUM		
Product code LH Version	HURRICANE.016		HURRICANE.013
Product code RH Version	2 port HURRICANE.017	3 port	HURRICANE.014
Product code UH Version	HURRICANE.018		HURRICANE.015
Weight	3,74 kg (8.24 lbs)		

WEIGHT 3,70 kg (8.15 lbs)
MAX TORQUE 4300 Nm (3172 ft-lbs)
AIR INLET 3/8" BSP

- More gap between tightening and loosening
- Improved air motor performance
- Lost wax casting handle

HIGHLIGHTS

HURRICANE LH



The fast left hand version (blue) loosens nuts tightened clockwise faster

HURRICANE RH



The fast right hand version (red) loosens nuts tightened anticlockwise faster

HURRICANE UH



The special unhanded version (black) loosens at same speed both the nuts tightened clockwise and anticlockwise

AVAILABLE VERSIONS



Operating and maintenance manual

HURRICANE





HURRICANE 90° ANGLED HANDLE

BEST PRACTICE

FORMULA 1 / FORMULA 2
INDYCAR / DTM

Product name	HURRICANE 90° ANGLED HANDLE		
Front Cover Type	CARBON COVER		
Product code LH Version	HURRICANE.010		HURRICANE.007
Product code RH Version	2 port HURRICANE.011	3 port	HURRICANE.008
Product code UH Version	HURRICANE.012		HURRICANE.009
Square drive	1"		
Weight	3,70 kg (8.15 lbs)		
Length	200 mm (7.87")		
Air inlet	3/8" BSP		
Supply hose inside diameter	13 mm (0.51")		
Max pressure	25 bar (362 psi)		
Free Speed	LH / RH 15000 rpm		
(25 bar / 362 psi)	UH 14800 rpm		
Max torque	LH / RH 4300 Nm (3172 ft-lbs)		
	UH 4200 Nm (3100 ft-lbs)		

ALSO AVAILABLE

Product name	HURRICANE 90° ANGLED HANDLE		
Front Cover Type	AEROSPACE 7075 ALUMINIUM		
Product code LH Version	HURRICANE.004		HURRICANE.001
Product code RH Version	2 port HURRICANE.005	3 port	HURRICANE.002
Product code UH Version	HURRICANE.006		HURRICANE.003
Weight	3,74 kg (8.24 lbs)		

WEIGHT 3,70 kg (8.15 lbs)
MAX TORQUE 4300 Nm (3172 ft-lbs)
AIR INLET 3/8" BSP

- More gap between tightening and loosening
- Improved air motor performance
- Lost wax casting handle

HIGHLIGHTS

HURRICANE LH



The fast left hand version (blue) loosens nuts tightened clockwise faster

HURRICANE RH



The fast right hand version (red) loosens nuts tightened anticlockwise faster

HURRICANE UH



The special unhanded version (black) loosens at same speed both the nuts tightened clockwise and anticlockwise

AVAILABLE VERSIONS



Operating and maintenance manual

HURRICANE





DP 6000 CLASSIC HANDLE

BEST PRACTICE
FORMULA 1 / INDYCAR / FORMULA 2

Product name	DP 6000 CLASSIC HANDLE
Front Cover Type	CARBON COVER
Product code LH Version	006000.00017
Product code RH Version	006000.00018
Product code UH Version	006000.00019
Square drive	1"
Weight	3,50 kg (7.7 lbs)
Length	198 mm (7.79")
Air inlet	3/8" BSP
Supply hose inside diameter	13 mm (0.51")
Max pressure	25 bar (362 psi)
Free Speed (25 bar / 362 psi)	LH / RH 14700 rpm UH 14300 rpm
Max torque	LH / RH 4200 Nm (3100 ft-lbs) UH 4000 Nm (2950 ft-lbs)
Gun selector plate	3 port (2 port available on demand)

ALSO AVAILABLE

Product name	DP 6000 CLASSIC HANDLE
Front Cover Type	AEROSPACE 7075 ALUMINIUM
Product code LH Version	006000.00014
Product code RH Version	006000.00015
Product code UH Version	006000.00016
Weight	3,54 kg (7.8 lbs)

WEIGHT 3,50 kg (7.7 lbs)
MAX TORQUE 4200 Nm (3100 ft-lbs)
AIR INLET 3/8" BSP

- More power / more gap
- Metallic powder painted body
- Body made of magnesium alloy

HIGHLIGHTS

DP 6000 LH



The fast left hand version (blue) loosens nuts tightened clockwise faster

DP 6000 RH



The fast right hand version (red) loosens nuts tightened anticlockwise faster

DP 6000 UH



The special unhanded version (black) loosens at same speed both the nuts tightened clockwise and anticlockwise

AVAILABLE VERSIONS



Operating and maintenance manual

DP 6000



DP 6000

90° ANGLED HANDLE

BEST PRACTICE

FORMULA 1 / INDYCAR / FORMULA 2



Product name	DP 6000 90° ANGLED HANDLE
Front Cover Type	CARBON COVER
Product code LH Version	006000.00004
Product code RH Version	006000.00005
Product code UH Version	006000.00006
Square drive	1"
Weight	3,50 kg (7.7 lbs)
Length	198 mm (7.79")
Air inlet	3/8" BSP
Supply hose inside diameter	13 mm (0.51")
Max pressure	25 bar (362 psi)
Free Speed (25 bar / 362 psi)	LH / RH 14700 rpm UH 14300 rpm
Max torque	LH / RH 4200 Nm (3100 ft-lbs) UH 4000 Nm (2950 ft-lbs)
Gun selector plate	3 port (2 port available on demand)

ALSO AVAILABLE

Product name	DP 6000 90° ANGLED HANDLE
Front Cover Type	AEROSPACE 7075 ALUMINIUM
Product code LH Version	006000.00001
Product code RH Version	006000.00002
Product code UH Version	006000.00003
Weight	3,54 kg (7.8 lbs)

WEIGHT 3,50 kg (7.7 lbs)
MAX TORQUE 4200 Nm (3100 ft-lbs)
AIR INLET 3/8" BSP

- More power / more gap
- Metallic powder painted body
- Body made of magnesium alloy

HIGHLIGHTS

DP 6000 LH



The fast left hand version (blue) loosens nuts tightened clockwise faster

DP 6000 RH



The fast right hand version (red) loosens nuts tightened anticlockwise faster

DP 6000 UH



The special unhanded version (black) loosens at same speed both the nuts tightened clockwise and anticlockwise

AVAILABLE VERSIONS



Operating and maintenance manual

DP 6000





DP 6000 BIAS

BEST PRACTICE

ENDURANCE / IMSA / LE MANS SERIES

Product name	DP 6000 BIAS
Front Cover Type	CARBON COVER
Product code	6000BS.00001
Square drive	1"
Weight	3,68 kg (8.11 lbs)
Length	198 mm (7.79")
Air inlet	3/8" BSP
Supply hose inside diameter	13 mm (0.51")
Max pressure	25 bar (362 psi)
Free Speed (25 bar / 362 psi)	14300 rpm
Max torque	3900 Nm (2876 ft-lbs)

ALSO AVAILABLE

Product name	DP 6000 BIAS
Front Cover Type	AEROSPACE 7075 ALUMINIUM
Product code	6000BS.00002
Weight	3,75 kg (8.27 lbs)

WEIGHT 3,68 kg (8.11 lbs)
MAX TORQUE 3900 Nm (2876 ft-lbs)
AIR INLET 3/8" BSP

- Simply faster!
- 2 wheel guns in 1

THE BIAS SYSTEM

The BIAS SYSTEM gives you both RH and LH versions inside a single wheel gun. Using the special lever you can change the mode during the pitstop.

This model is particularly suitable for those championships in which the use of a single wheel gun is mandatory.

The BIAS SYSTEM is capable to give to the operator all the advantages of both the RH and LH modes in a single wheel gun.



Operating and maintenance manual
DP 6000 BIAS

THE BIAS SYSTEM

HIGHLIGHTS



ON TOP LEVER
FROM RH TO LH
FROM LH TO RH

BIAS SYSTEM
RH & LH versions included
in a single wheel gun

BLACK ANODIZED ALUMINIUM
LEVER ON DEMAND

CUSTOMIZABLE LEVER

COVER

- Double option:
- Carbon Cover (standard)
 - Aluminium Cover (optional)

SUGGESTED COUPLINGS & FITTINGS

- couplings: minimal bore of 10 mm (25/64")
- male 1/2" BSP fittings

NEW



DP 4000 MG

BEST PRACTICE

FORMULA 1 / FORMULA 2 / DTM



Product name	DP 4000 MG
Front Cover Type	AEROSPACE 7075 ALUMINIUM
Product code LH Version	4000MG.00037
Product code RH Version	4000MG.00038
Product code UH Version	4000MG.00039
Square drive	1"
Weight	3,71 kg (8.18 lbs)
Length	193 mm (7.59")
Air inlet	3/8" BSP
Supply hose inside diameter	13 mm (0.51")
Max pressure	20 bar (290 psi)
Free Speed 20 bar (290 psi)	LH / RH 13500 rpm UH 12500 rpm
Max torque	LH / RH 3500 Nm (2590 ft-lbs) UH 3300 Nm (2442 ft-lbs)
Gun selector plate	3 port (2 port available on demand)

ALSO AVAILABLE

Product name	DP 4000 MG
Front Cover Type	CARBON COVER
Product code LH Version	4000MG.00040
Product code RH Version	4000MG.00041
Product code UH Version	4000MG.00042
Weight	3,64 kg (8.02 lbs)

WEIGHT 3,71 kg (8.18 lbs)
MAX TORQUE 3500 Nm (2590 ft-lbs)
AIR INLET 3/8" BSP

- powerful
- light
- reliable

HIGHLIGHTS

DP 4000 MG LH



The fast left hand version (blue) loosens nuts tightened clockwise faster

DP 4000 MG RH



The fast right hand version (red) loosens nuts tightened anticlockwise faster

DP 4000 MG UH



The special unhanded version (black) loosens at same speed both the nuts tightened clockwise and anticlockwise

AVAILABLE VERSIONS

THE FIRST GUN TO BE EQUIPPED WITH
MAGNESIUM ALLOY BODY

BUILT-IN FRS

7 CARBON PEEK
VANES INSIDE

AERONAUTICAL ALUMINIUM
FRONT COVER

SUGGESTED COUPLINGS & FITTINGS

- couplings: minimal bore of 10 mm (25/64")
- male 1/2" BSP fittings



Operating and maintenance manual

DP 4000 MG



DP 4000 30BAR

BEST PRACTICE
FORMULA 1 / INDYCAR

Product name	DP 4000 30BAR
Front Cover Type	AEROSPACE 7075 ALUMINIUM
Product code LH Version	400030.00013
Product code RH Version	400030.00014
Product code UH Version	400030.00015
Square drive	1"
Weight	3,97 kg (8.7 lbs)
Length	193 mm (7.59")
Air inlet	3/8" BSP
Supply hose inside diameter	13 mm (0.51")
Max pressure	30 bar (435 psi)
Free Speed 30 bar (435 psi)	LH / RH / UH 15500 rpm
Max torque	LH / RH 3800 Nm (2810 ft-lbs) UH 3500 Nm (2590 ft-lbs)
Gun selector plate	3 port (2 port available on demand)

ALSO AVAILABLE

Product name	DP 4000 30BAR
Front Cover Type	CARBON COVER
Product code LH Version	400030.00016
Product code RH Version	400030.00017
Product code UH Version	400030.00018
Weight	3,90 kg (8.6 lbs)



WEIGHT 3,97 kg (8.7 lbs)
MAX TORQUE 3800 Nm (2810 ft-lbs)
AIR INLET 3/8" BSP

- Optional front cover made of carbon
- New carbon peek vane

HIGHLIGHTS

DP 4000 30BAR LH



The fast left hand version (blue) loosens nuts tightened clockwise faster

DP 4000 30BAR RH



The fast right hand version (red) loosens nuts tightened anticlockwise faster

DP 4000 30BAR UH



The special unhandred version (black) loosens at same speed both the nuts tightened clockwise and anticlockwise

AVAILABLE VERSIONS



Operating and maintenance manual

DP 4000 30BAR

AERONAUTICAL ALUMINIUM FRONT COVER

BUILT-IN FRS

STANDARD DOUBLE STAGE TRIGGER

- 30 BAR DYNAMIC RESISTANT
- INCREASED POWER
- VERY TOUGH MATERIALS AND TECHNICAL SOLUTIONS APPLIED

SUGGESTED COUPLINGS & FITTINGS

- couplings: minimal bore of 10 mm (25/64")
- male 1/2" BSP fittings





DP 3000 SUPERSPORT

BEST PRACTICE
FORMULA 2 / DTM / IMSA

Product name	3000 SUPERSPORT
Front Cover Type	AEROSPACE 7075 ALUMINIUM
Product code LH Version	3000SS.00001
Product code RH Version	3000SS.00002
Product code UH Version	3000SS.00003
Square drive	1"
Weight	4 kg (8.82 lbs)
Length	235 mm (9.25")
Air inlet	3/8" BSP
Supply hose inside diameter	13 mm (0.51")
Max pressure	20 bar (290 psi)
Free Speed	LH / RH 11500 rpm
20 bar (290 psi)	UH 11000 rpm
Max torque	LH / RH 3000 Nm (2213 ft-lbs)
	UH 2800 Nm (2065 ft-lbs)
Gun selector plate	3 port

ALSO AVAILABLE

Product name	3000 SUPERSPORT
Front Cover Type	CARBON COVER
Product code LH Version	3000SS.00004
Product code RH Version	3000SS.00005
Product code UH Version	3000SS.00006
Weight	3,93 kg (8.66 lbs)

WEIGHT 4 kg (8.82 lbs)
MAX TORQUE 3000 Nm (2213 ft-lbs)
AIR INLET 3/8" BSP

- Optional front cover made of carbon
- New carbon peek vane

HIGHLIGHTS

DP 3000 SUPERSPORT LH



The fast left hand version (blue) loosens nuts tightened clockwise faster

DP 3000 SUPERSPORT RH



The fast right hand version (red) loosens nuts tightened anticlockwise faster

DP 3000 SUPERSPORT UH



The special unhanded version (black) loosens at same speed both the nuts tightened clockwise and anticlockwise

AVAILABLE VERSIONS

AERONAUTICAL ALUMINIUM FRONT COVER

BUILT-IN FRS



SUGGESTED COUPLINGS & FITTINGS

- couplings: minimal bore of 10 mm (25/64")
- male 1/2" BSP fittings

NEW FAST REVERSE SYSTEM

Longer and easier to move.
Positioned on the side where the rotation reverse mechanism turns from loosening to tightening.



Operating and maintenance manual

DP 3000 SUPERSPORT





DP 2000 SE

BEST PRACTICE
IMSA / FORMULA 2

Product name	DP 2000 SE
Front Cover Type	AEROSPACE 7075 ALUMINIUM
Product code LH Version	2000SE.00010
Product code RH Version	2000SE.00011
Product code UH Version	2000SE.00012
Square drive	1"
Weight	3,90 kg (8.6 lbs)
Length	186 mm (7.32")
Air inlet	3/8" BSP
Supply hose inside diameter	13 mm (0.51")
Max pressure	20 bar (290 psi)
Free Speed	LH / RH 9500 rpm
20 bar (290 psi)	UH 9000 rpm
Max torque	LH / RH 2500 Nm (1843 ft-lbs)
	UH 2200 Nm (1622 ft-lbs)
Gun selector plate	2 port

ALSO AVAILABLE

Product name	DP 2000 SE
Front Cover Type	CARBON COVER
Product code LH Version	2000SE.00013
Product code RH Version	2000SE.00014
Product code UH Version	2000SE.00015
Weight	3,83 kg (8.4 lbs)

WEIGHT 3,90 kg (8.6 lbs)
MAX TORQUE 2500 Nm (1843 ft-lbs)
AIR INLET 3/8" BSP

- More power / more gap
- Metallic powder painted body
- Body made of magnesium alloy

HIGHLIGHTS

DP 2000 SE LH



The fast left hand version (blue) loosens nuts tightened clockwise faster

DP 2000 SE RH



The fast right hand version (red) loosens nuts tightened anticlockwise faster

DP 2000 SE UH



The special unhanded version (black) loosens at same speed both the nuts tightened clockwise and anticlockwise

AVAILABLE VERSIONS

6 NEW CARBON VANES INSIDE



NEW AERONAUTICAL ALUMINIUM FRONT COVER AS STANDARD (carbon cover optional on demand)

THE CLASSIC PAOLI GUN

From 18 years always on the pit-lanes

- Lighter
- More powerful
- Evergreen

SUGGESTED COUPLINGS & FITTINGS

- couplings: minimal bore of 7,6 mm (19/64")
- male 3/8" BSP fittings



Operating and maintenance manual

DP 2000 SE





DP 197 SFE

BEST PRACTICE
GT / ENDURANCE

Product name	DP 197 SFE
Product code LH Version	197SFE.00006
Product code RH Version	197SFE.00007
Product code UH Version	197SFE.00008
Square drive	1"
Weight	4,60 kg (10 lbs)
Length	200 mm (7.87")
Air inlet	3/8" BSP
Supply hose inside diameter	13 mm (0.51")
Max pressure	20 bar (290 psi)
Free Speed (20 bar / 290 psi)	LH / RH 7900 rpm UH 7500 rpm
Max torque	LH / RH 1900 Nm (3100 ft-lbs) UH 1800 Nm (2950 ft-lbs)
Gun selector plate	2 port

WEIGHT 4,60 kg (10 lbs)
MAX TORQUE 1900 Nm (3100 ft-lbs)
AIR INLET 3/8" BSP

- Light weight
- New carbon vanes
- Very reliable

HIGHLIGHTS

DP 197 SFE LH



The fast left hand version (blue) loosens nuts tightened clockwise faster

DP 197 SFE RH



The fast right hand version (red) loosens nuts tightened anticlockwise faster

DP 197 SFE UH



The special unhanded version (black) loosens at same speed both the nuts tightened clockwise and anticlockwise

AVAILABLE VERSIONS



Operating and maintenance manual

DP 197 SFE



6 NEW CARBON VANES INSIDE

AERONAUTICAL ALUMINIUM
FRONT COVER

SUGGESTED COUPLINGS & FITTINGS

- couplings: minimal bore of 7,6 mm (19/64")
- male 3/8" BSP fittings

DP 177 SFE

BEST PRACTICE
GT / ENDURANCE



Product name	DP 177 SFE
Product code LH Version	177SFE.00004
Product code RH Version	177SFE.00005
Product code UH Version	177SFE.00006
Square drive	1"
Weight	4,20 kg (9.2 lbs)
Length	193 mm (7.59")
Air inlet	3/8" BSP
Supply hose inside diameter	13 mm (0.51")
Max pressure	20 bar (290 psi)
Free Speed (20 bar / 290 psi)	LH / RH 10000 rpm UH 9500 rpm
Max torque	LH / RH 1900 Nm (1400 ft-lbs) UH 1800 Nm (1327 ft-lbs)
Gun selector plate	2 port

WEIGHT 4,20 kg (9.2 lbs)
MAX TORQUE 1900 Nm (1400 ft-lbs)
AIR INLET 3/8" BSP

- Fast, powerful and reliable
- New carbon vanes
- Increased max pressure

HIGHLIGHTS

DP 177 SFE LH



The fast left hand version (blue) loosens nuts tightened clockwise faster

DP 177 SFE RH



The fast right hand version (red) loosens nuts tightened anticlockwise faster

DP 177 SFE UH



The special unhanded version (black) loosens at same speed both the nuts tightened clockwise and anticlockwise

AVAILABLE VERSIONS



Operating and maintenance manual

DP 177 SFE



AERONAUTICAL ALUMINIUM
FRONT COVER

6 NEW CARBON VANES INSIDE

SUGGESTED COUPLINGS & FITTINGS

- couplings: minimal bore of 7,6 mm (19/64")
- male 3/8" BSP fittings

DP 176 SFE

BEST PRACTICE
PORSCHE / IMSA



Product name	DP 176 SFE
Product code LH Version	176SFE.00005
Product code RH Version	176SFE.00006
Product code UH Version	176SFE.00007
Square drive	3/4"
Weight	3,95 kg (8.7 lbs)
Length	185 mm (7.28")
Air inlet	3/8" BSP
Supply hose inside diameter	13 mm (0.51")
Max pressure	20 bar (290 psi)
Free Speed (20 bar / 290 psi)	LH / RH 10000 rpm UH 9500 rpm
Max torque	LH / RH 1700 Nm (1260 ft-lbs) UH 1600 Nm (1180 ft-lbs)
Gun selector plate	2 port

WEIGHT 3,95 kg (8.7 lbs)
MAX TORQUE 1700 Nm (1260 ft-lbs)
AIR INLET 3/8" BSP

- Light weight
- New carbon vanes
- Increased max pressure

HIGHLIGHTS

DP 176 SFE LH



The fast left hand version (blue) loosens nuts tightened clockwise faster

DP 176 SFE RH



The fast right hand version (red) loosens nuts tightened anticlockwise faster

DP 176 SFE UH



The special unhandled version (black) loosens at same speed both the nuts tightened clockwise and anticlockwise

AVAILABLE VERSIONS



Operating and maintenance manual

DP 176 SFE



AERONAUTICAL ALUMINIUM
FRONT COVER

6 NEW CARBON VANES INSIDE

SUGGESTED COUPLINGS & FITTINGS

- couplings: minimal bore of 7,6 mm (19/64")
- male 3/8" BSP fittings



BLUE DEVIL

BEST PRACTICE
PORSCHE / IMSA

Product name **BLUE DEVIL 60/40**

Product code LH Version BDEVIL.00002

Product code RH Version BDEVIL.00004

Square drive 3/4"

Weight 2,69 kg (5.9 lbs)

Length 188 mm (7.4")

Air inlet 3/8" BSP

Supply hose inside diameter 13 mm (0.51")

Max pressure 20 bar (290 psi)

Free Speed
(20 bar / 290 psi) LH / RH 17000 rpm

Max torque LH / RH 1200 Nm (890 ft-lbs)

Gun selector plate 2 port

ALSO AVAILABLE

Product name **BLUE DEVIL 70/30**

Product code LH Version BDEVIL.00006

Product code RH Version BDEVIL.00008

Free Speed
(20 bar / 290 psi) LH / RH 17500 rpm

WEIGHT 2,69 kg (5.9 lbs)
MAX TORQUE 1200 Nm (890 ft-lbs)
AIR INLET 3/8" BSP

- Operating pressure 20 bar / 290 psi
- New carbon vanes
- Optimized and efficient exhaust (patented system)

HIGHLIGHTS

DP BLUE DEVIL LH



The fast left hand version (blue) loosens nuts tightened clockwise faster

DP BLUE DEVIL RH



The fast right hand version (red) loosens nuts tightened anticlockwise faster

AVAILABLE VERSIONS



Operating and maintenance manual

BLUE DEVIL

6 NEW CARBON VANES INSIDE



AERONAUTICAL ALUMINIUM
FRONT COVER

BUILT-IN FRS

SUGGESTED COUPLINGS & FITTINGS

- couplings: minimal bore of 7,6 mm (19/64")
- male 3/8" BSP fittings

RED DEVIL 2.0 STREET LEGAL

BEST PRACTICE
TOURING



Product name	RED DEVIL 2.0 STREET LEGAL
Product code	RDEVSL.00003
Square drive	1/2"
Weight	2,40 kg (5.3 lbs)
Length	192 mm (7.56")
Air inlet	1/4" NPT
Supply hose inside diameter	13 mm (0.51")
Max pressure	14 bar (200 psi)
Free Speed (12 bar / 175 psi)	12.000 rpm
Max torque	1.000 Nm (740 ft-lb)
Gun selector plate	3 port

WEIGHT 2,40 kg (5.3 lbs)
MAX TORQUE 1.000 Nm (740 ft-lb)
AIR INLET 1/4" NPT

HIGHLIGHTS



Operating and maintenance manual

RED DEVIL 2.0
STREET LEGAL

6 NEW CARBON VANES INSIDE

PROTECTIVE PVC COVER

AERONAUTICAL ALUMINIUM
FRONT COVER

BUILT-IN FRS

SUGGESTED COUPLINGS & FITTINGS

- couplings: minimal bore of 7,6 mm (19/64")
- male 1/4" NPT fittings





DP 36 SF EVO

BEST PRACTICE
TOURING

Product name	DP 36 SF EVO
Product code LH Version	36SFEV.00005
Product code RH Version	36SFEV.00006
Product code LH Version*	36SFEV.00007
Square drive	1/2"
Weight	2,23 kg (4.9 lbs)
Length	161 mm (6.3")
Air inlet	LH / RH 3/8" BSP LH* 1/4" NPT
Supply hose inside diameter	13 mm (0.51")
Max pressure	14 bar (200 psi)
Free Speed (14 bar / 200 psi)	LH / RH 14500 rpm LH* 15000 rpm
Max torque	LH / RH 850 Nm (626 ft-lbs) LH* 900 Nm (663 ft-lbs)
Gun selector plate	2 port

*US VERSION

WEIGHT 2,23 kg (4.9 lbs)
MAX TORQUE 900 Nm (663 ft-lbs)
AIR INLET 3/8" BSP

- New carbon vanes
- Developed for 5 nuts
- Additional air exhausts to increase the speed

HIGHLIGHTS

DP 36 SF EVO LH



The fast left hand version (blue) loosens nuts tightened clockwise faster

DP 36 SF EVO RH



The fast right hand version (red) loosens nuts tightened anticlockwise faster

AVAILABLE VERSIONS



Operating and maintenance manual

DP 36 SF EVO

6 NEW CARBON VANES INSIDE

TWIN HAMMER MECHANISM

BUILT-IN FRS

AERONAUTICAL ALUMINIUM FRONT COVER



VERY FAST!

Wheel gun for 5 nuts wheels (touring) application!

SUGGESTED COUPLINGS & FITTINGS

- couplings: minimal bore of 7,6 mm (19/64")
- male 3/8" BSP fittings (UE version)
1/4" NPT fittings (US version)



TYPHOON

BEST PRACTICE TOURING



Product name	TYPHOON 1/2"
Product code	A.08.0006
Version	Cordless
Square drive	1/2"
Weight (with battery)	3.66 kg (8.07 lbs)
Length	231 mm (9.10")
Width	87 mm (3.42")
Height	290 mm (11.42")
Voltage	20.0V d.c.
Free speed	1650 rpm
Max torque	880 Nm (650 ft-lbs)

ALSO AVAILABLE

Product name	TYPHOON 3/4"
Product code	A.08.0007
Square drive	3/4"
Weight (with battery)	3.70 kg (8.16 lbs)
Length	233 mm (9.17")
Max torque	1000 Nm (885 ft-lbs)

WEIGHT 3.66 kg (8.07 lbs)
MAX TORQUE 1000 Nm (885 ft-lbs)
VOLTAGE 20.0V d.c.

- Fast and powerful
- Provided in a hard case
- 2 Batteries included, one in use and one as a spare

HIGHLIGHTS



Operating and maintenance manual

TYPHOON

FAST AND POWERFUL
CORDLESS GUN

2 JAWS HAMMER MECHANISM



ERGONOMIC HANDLE

LITHIUM ION BATTERY
20.0 V D.C.



ROCKET

BEST PRACTICE TOURING



Product name	ROCKET
Product code	A.08.0004
Version	Cordless
Square drive	1/2"
Weight (without battery)	2.15 kg (4,74 lbs)
Length	242 mm (9.5")
Width	80 mm (3.1")
Height	255 mm (10")
Voltage	20.0V d.c.
Free speed	1650 rpm
Max torque	540 Nm (400 ft-lbs)

WEIGHT 2.15 kg (4,74 lbs)
MAX TORQUE 540 Nm (400 ft-lbs)
VOLTAGE 20.0V d.c.

- Light and compact
- Built-in torque selection system
- Six Torque Sections

HIGHLIGHTS



LIGHTER AND
MORE COMPACT!

2 JAWS HAMMER MECHANISM



TORQUE
SELECTION SYSTEM

ERGONOMIC HANDLE



Operating and maintenance manual

ROCKET



STORM

BEST PRACTICE TOURING



Product name	STORM
Product code	A.08.0005
Version	Cordless
Square drive	1/2"
Weight (with battery)	1,66 kg (3.66 lbs)
Length	154 mm (6.06")
Width	76 mm (3")
Height	239 mm (9.41")
Voltage	20.0V d.c.
Free speed	2300 rpm
Max torque	350 Nm (260 ft-lbs)

WEIGHT 1,66 kg (3.66 lbs)
MAX TORQUE 350 Nm (260 ft-lbs)
VOLTAGE 20.0V d.c.

- Light and compact
- Built-in torque selection system
- Led light

HIGHLIGHTS



Operating and maintenance manual

STORM

LIGHTER AND
MORE COMPACT!

2 JAWS HAMMER MECHANISM

LED LIGHT

ERGONOMIC HANDLE

POWER INDICATOR

LITHIUM ION BATTERY
20.0 V D.C.



4BIKE





MOTORCYCLE SPORT

The new motorcycle wheel guns and accessories

4BIKE

BEST PRACTICE FORMULA EWC - SUPERSTOCK

Product name	4BIKE
Product code	04BIKE.00001
Square drive	1/2"
Weight	2,23 kg (4.9 lbs)
Length	161 mm (6.3")
Air inlet	3/8" BSP
Supply hose inside diameter	13 mm (0.51")
Max pressure	14 bar (200 psi)
Operating pressure	10/14 bar (150/200 psi)
Free Speed - Loosening (14 bar / 200 psi)	14800 rpm
Free Speed - Tightening (14 bar / 200 psi)	11500 rpm
Max torque - Loosening (14 bar / 200 psi)	1025 Nm (756 ft-lbs)
Max torque - Tightening (14 bar / 200 psi)	850 Nm (627 ft-lbs)
Gun selector plate	2 port

WEIGHT 2,23 kg (4.9 lbs)
MAX TORQUE 1025 Nm (756 ft-lbs)
AIR INLET 3/8" BSP

- New carbon vanes
- Developed for 5 nuts
- Additional air exhausts to increase the speed
- Less powered on tightening

HIGHLIGHTS

4BIKE LH



The fast left hand version (blue) loosens nuts tightened clockwise faster



AVAILABLE VERSIONS



Operating and maintenance manual

4BIKE



DP 1050



PRODUCT CODE	001050.00001
SQUARE DRIVE	1/2"
BOLT RANGE	M10-M16
ULTIMATE TORQUE	700 Nm (518 ft-lb)
WORKING TORQUE	100-600 Nm (74-444 ft-lb)
WEIGHT	1,3 kg (2.87 lbs)
FREE SPEED	9.000 rpm
IMPACTS NUMBER	1.150/min
MAX WORKING PRESSURE	6,3 bar (91 psi)
AIR INLET	1/4" NPT
INNER HOSE DIAMETER	9,5 mm (0.374")
LENGTH (WITHOUT ANVIL)	92 mm (3.62")

BUTTERFLY



PRODUCT CODE	BUTTERFLY.001
SQUARE DRIVE	3/8"
BOLT RANGE	M10
MAX TORQUE	108 Nm (80 ft-lb)
WORKING TORQUE	10-100 Nm (10-75 ft-lb)
WEIGHT	0,53 kg (1.17 lbs)
FREE SPEED	12.000 rpm
IMPACTS NUMBER	1.000/min
MAX WORKING PRESSURE	6,3 bar (91 psi)
AIR INLET	1/4" NPT
INNER HOSE DIAMETER	9,5 mm (0.374")
LENGTH (WITHOUT ANVIL)	130 mm (5.11")

AIR PRESSURE REGULATOR F4

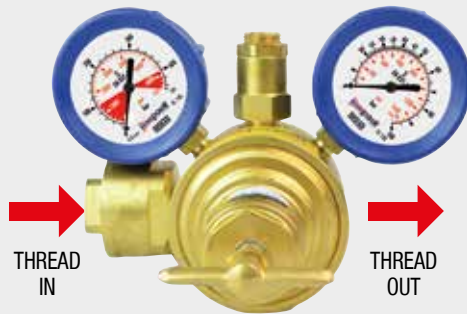

PISTON MECHANISM

CODE	B.40.0005	B.40.0030	B.40.0042
INLET PRESSURE	220 bar	220 bar	350 bar
MAX FLOW (20 BAR/OUT)	400 Nm ³ /h	400 Nm ³ /h	500 Nm ³ /h
GAUGES IN	0-450 bar	0-6500 PSI	0-450 bar
GAUGES OUT	0-100 bar	0-870 PSI	0-100 bar
OVER PRESSURE VALVE SETTING	50 bar	50 bar	50 bar
THREAD IN	1/4" BSP	1/4" BSP	1/4" BSP
THREAD OUT	3/8" BSP	3/8" BSP	3/8" BSP
FLOW	high	high	high
AIRJACK	•	•	•
HIGH FLOW FILTER	•	•	•
BALANCED	•	•	•

TURNING CONNECTORS

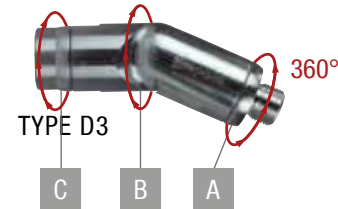
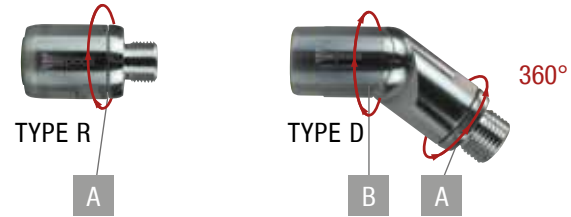

	PRODUCT CODE	MALE/FEMALE	INSIDE DIAMETER
TYPE D	B.43.0001	3/8" BSP	11 mm
TYPE R	B.43.0003	3/8" BSP	11 mm
TYPE D3	B.43.0002	3/8" BSP	11 mm

QUICK RELEASE COUPLINGS 3/8"



ESAFE SYSTEM - WITH SAFETY OUTLET

The new couplings eSafe by Cejn offer a higher flow, a compact design. They are extremely durable and easy to handle. They also have a function of safety outlet.

PRODUCT CODE	PRODUCT NAME	INSIDE DIAMETER	THREAD
B.42.0008	320-5154	7,6 mm (19/64")	3/8" bspt
B.42.0052	320-2204	7,6 mm (19/64") ID 60°	3/8" bsp
B.42.0009	320-5264	7,6 mm (19/64") ID 60°	3/8" bsp
B.42.0050	320-2154	7,6 mm (19/64")	3/8" bspt

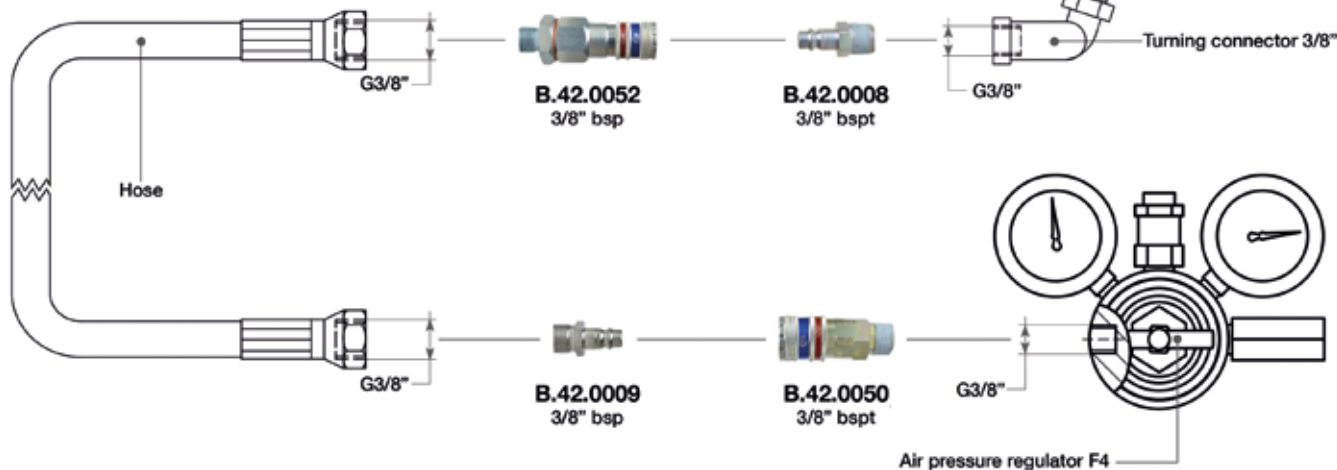
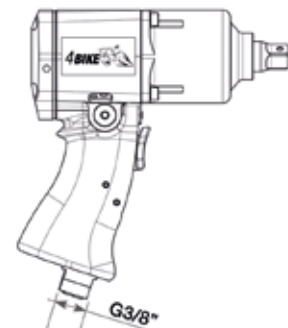

HOSES



Technical data - bore size: 13 mm,
braid od: 23,5 mm, working pressure: 75 bar.

A - SELECT LENGTH

CODE	LENGTH
B.41.1005	5 m
B.41.1006	6 m
B.41.1007	7 m

B, C - SELECT COUPLINGS

	ANGLE	3/8"
	0°	B.41.5002
Female	45°	B.41.5005
	90°	B.41.5008

COVERS



B.18.0006
4BIKE
TRANSPARENT
PLASTIC COVER

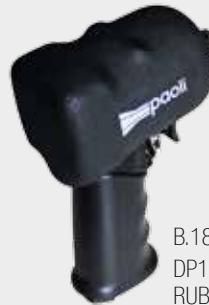

B.18.0037
DP1050
RUBBER COVER

AVAILABLE FOR	PRODUCT CODE
4BIKE	B.18.0006
DP1050	B.18.0037

AIR BOTTLE COMPRESSOR



DPH220

PRODUCT CODE	B.21.0102
PRODUCT NAME	DPH220
ENGINE	Single-phase Electric 2,2kW - 3,0HP
CAPACITY	100 l/min - 3,5 CFM - 6 m ³ /h
OPERATING PRESSURE	300 bar (4350 psi)
FILLING TIME	20' (air bottle 10 l - 0-200 bar)
NOISE LEVEL	79 dB
OVERALL DIMENSIONS	58x41x41 cm 22 7/8x16 9/64x16 9/64 inch
DRY WEIGHT	42,5 kg (93,7 lb)

NEW

WHEEL NUT SOCKETS CUSTOMIZED DESIGN



Polygonal 30 mm



Polygonal 27 mm

CODE	SQUARE DRIVE	MATERIAL	WEIGHT
B.28.0071	1/2"	steel	245 g (0.54 lbs)
B.28.0072	1/2"	titanium	160 g (0.35 lbs)

CODE	SQUARE DRIVE	MATERIAL	WEIGHT
B.28.0069	1/2"	steel	225 g (0.49 lbs)
B.28.0070	1/2"	titanium	140 g (0.31 lbs)

On demand we are able to produce and supply more wheel nut sockets for different specific needs.



PAOLI SOCKETS

The new Paoli wheel nut sockets

PAOLI SOCKETS

WHEEL NUT SOCKETS



The new Paoli sockets are an unprecedented product and the result of a long and complex engineering research. Continued consultation with many race customers has ensured that the Paoli Sockets' technological development goes hand in hand with the real needs of racing teams in terms of versatility, safety, materials and maintenance.

- Three different materials: titanium, special steel and aeronautical aluminium. The first and the second are suitable for the race application, the third one is suitable for non-intensive use and torque wrench.
- Innovative design, attractive shapes and aesthetically pleasing.
- Accuracy in fitting the socket to the square drive, perfect clearance that allows the socket to be assembled and disassembled just by hand.
- Innovative safety system to insert the pin through the socket/square drive hole. Revolutionary system when assembling the socket by using the circlip and an 'O' ring on the cover. Maximum safety, a fine fitting and a considerably reduced assembly time.
- Insertion of service holes for maintenance of magnets: replacing magnets is quick and easy, with a simple plug-locator.
- Internal 'O' ring retaining nut made from new Paoli Sockets material. The customized resin gives the socket an ideal grip with its high gripping power.
- The Paoli Sockets Service Kit for the maintenance and replacement of worn parts contains everything needed to work on the socket simply and safely. A brief instruction manual indicates the optimum way to carry out operations (E.g. replacement and subsequent refinement of magnets).

Internal 'O' ring retaining nut especially made for Paoli Sockets.

Also available in aeronautical aluminium, suitable for torque wrench applications.

Innovative safety system.

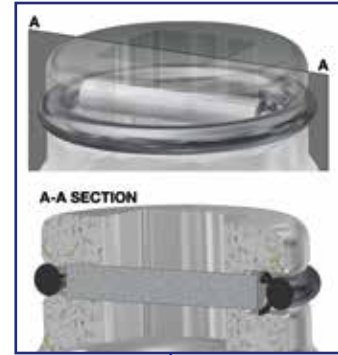

Replacing magnets is quick and easy thanks to rear service holes.

Accuracy in fitting the socket to the wrench (minimal clearance).

Innovative design, attractive shapes and aesthetically pleasing.



User manual

SOCKETS



CHOOSE YOUR PAOLI SOCKET



SOCKETS "WITH FINGERS"

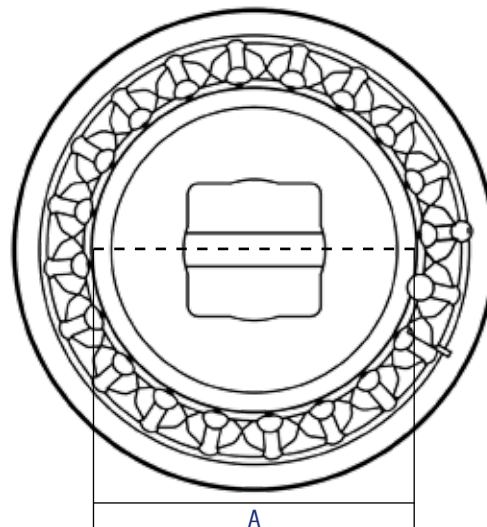

CODE	PAGE	CODE	PAGE	CODE	PAGE
B.28.0031	60	B.28.0041	62	B.28.0042	64
B.28.0040	60	B.28.0029	63	B.28.0058	64
B.28.0046	60	B.28.0038	63	B.28.0051	64
B.28.0063	60	B.28.0030	63	B.28.0050	65
B.28.0052	61	B.28.0032	64	B.28.0059	66
B.28.0033	62	B.28.0032	64		

CHOOSE YOUR PAOLI SOCKET

HEXAGONAL SOCKETS

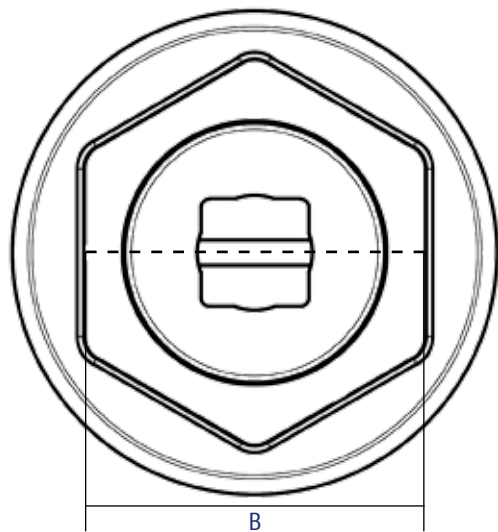

CODE	PAGE
B.28.0028	61
B.28.0037	62
B.28.0077	62
B.28.0064	65

DODECAGONAL SOCKETS

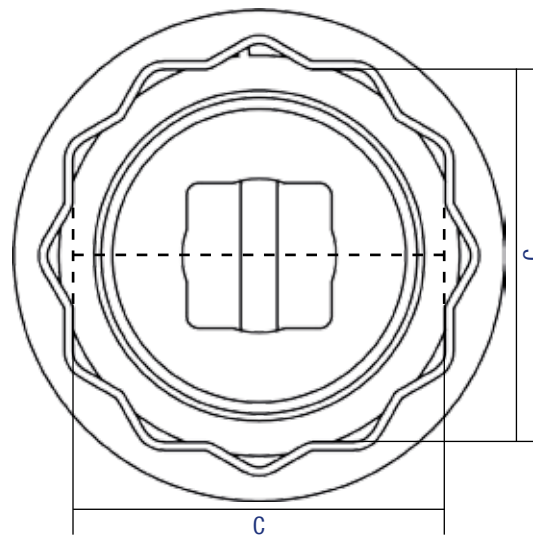

CODE	PAGE	CODE	PAGE
B.28.0016	61	B.28.0034	67
B.28.0015	62	B.28.0035	67
B.28.0062	66	B.28.0067	68
B.28.0061	67		

BEST PRACTICE → PORSCHE CUP, ENDURANCE

NEW SAFER ENGINEERING: THE MAGNETS ARE MOUNTED FROM THE BACK!



PORSCHE 911 RSR - 997 RSR

CODE	B.28.0031	B.28.0040	B.28.0046
SQUARE DRIVE	1"	1"	1" long
MATERIAL	titanium	aluminium	titanium
A	58,5 mm	58,5 mm	58,5 mm
RETENTION SYSTEM	magnets and o-ring	magnets and o-ring	magnets and o-ring
TEETH NUMBER	18	18	18

PORSCHE 991 RSR

CODE	B.28.0063
SQUARE DRIVE	1" long
MATERIAL	titanium
A	58,5 mm
RETENTION SYSTEM	magnets
TEETH NUMBER	18

BEST PRACTICE → PORSCHE CUP, ENDURANCE



B.28.0028

PORSCHE 996/997 CUP

CODE	B.28.0028	B.28.0016
SQUARE DRIVE	3/4"	3/4"
MATERIAL	steel	steel
B	36 mm	
C		32 mm
RETENTION SYSTEM	magnets, balls and springs	n.a.



B.28.0052

PORSCHE 991 CUP

CODE	B.28.0052
SQUARE DRIVE	1"
MATERIAL	aluminium
A	65 mm
RETENTION SYSTEM	o-ring
TEETH NUMBER	15

Available on demand

BEST PRACTICE → INDYCAR

NEW SAFER ENGINEERING: THE MAGNETS ARE MOUNTED FROM THE BACK!



B.28.0033

B.28.0041

INDYCAR

CODE	B.28.0033	B.28.0041
SQUARE DRIVE	1"	1"
MATERIAL	titanium	aluminium
A	65,26 mm	65,26 mm
RETENTION SYSTEM	magnets and o-ring	magnets and o-ring
TEETH NUMBER	20	20

BEST PRACTICE → FERRARI CHALLENGE



B.28.0037

B.28.0015

FERRARI 430 CHALLENGE

CODE	B.28.0037	B.28.0077	B.28.0015
SQUARE DRIVE	1"	3/4"	1"
MATERIAL	aluminium	aluminium	steel
B	80 mm	80 mm	
C			80 mm
RETENTION SYSTEM	balls and springs	balls and springs	n.a.

BEST PRACTICE → FERRARI ENDURANCE

NEW SAFER ENGINEERING: THE MAGNETS ARE MOUNTED FROM THE BACK!



B.28.0038

B.28.0029

F430

CODE	B.28.0029	B.28.0038
SQUARE DRIVE	1"	1"
MATERIAL	titanium	aluminium
A	68,42 mm	68,42 mm
RETENTION SYSTEM	magnets and o-ring	magnets and o-ring
TEETH NUMBER	24	24



B.28.0039

B.28.0030

F458 GT2

CODE	B.28.0030	B.28.0039
SQUARE DRIVE	1"	1"
MATERIAL	titanium	aluminium
A	57,9 mm	57,9 mm
RETENTION SYSTEM	magnets and o-ring	magnets and o-ring
TEETH NUMBER	24	24

BEST PRACTICE → FERRARI ENDURANCE

NEW SAFER ENGINEERING: THE MAGNETS ARE MOUNTED FROM THE BACK!



B.28.0042

B.28.0032

F458 GT3 (14 slots nut)

CODE	B.28.0032	B.28.0042
SQUARE DRIVE	1"	1"
MATERIAL	titanium	aluminium
A	69,18 mm	69,18 mm
RETENTION SYSTEM	magnets and o-ring	magnets and o-ring
TEETH NUMBER	28	28



B.28.0051

B.28.0058

F488

CODE	B.28.0058	B.28.0051
SQUARE DRIVE	1"	1"
MATERIAL	titanium	aluminium
A	59 mm	59 mm
RETENTION SYSTEM	n.a.	n.a.
TEETH NUMBER	24	24

BEST PRACTICE → LAMBORGHINI SUPER TROFEO



HURACAN SUPER TROFEO

CODE	B.28.0064
SQUARE DRIVE	1"
MATERIAL	aluminium
B	70 mm
RETENTION SYSTEM	magnets

BEST PRACTICE → LAMBORGHINI ENDURANCE

NEW SAFER ENGINEERING: THE MAGNETS ARE MOUNTED FROM THE BACK!



HURACAN GT3

CODE	B.28.0050
SQUARE DRIVE	1"
MATERIAL	steel
A	49,5 mm
RETENTION SYSTEM	magnets
TEETH NUMBER	20

BEST PRACTICE → MERCEDES SL3



MERCEDES SL3

CODE	B.28.0059
SQUARE DRIVE	1"
MATERIAL	steel
A	61 mm
RETENTION SYSTEM	pin, circlip and o-ring
TEETH NUMBER	24

BEST PRACTICE → SUPER FORMULA



SUPER FORMULA

CODE	B.28.0062
SQUARE DRIVE	1"
MATERIAL	steel
C	65 mm
RETENTION SYSTEM	harmonic ring

BEST PRACTICE → FORMULA 2



FORMULA 2

CODE	B.28.0061
SQUARE DRIVE	1"
MATERIAL	titanium
C	65 mm
RETENTION SYSTEM	harmonic ring

BEST PRACTICE → GP3 WSR F3



B.28.0035

B.28.0034

GP3 WSR F3

CODE	B.28.0034	B.28.0035
SQUARE DRIVE	1"	3/4"
MATERIAL	steel	steel
C	55 mm	55 mm
RETENTION SYSTEM	balls and springs	balls and springs



SUPER TC2000

CODE	B.28.0067
SQUARE DRIVE	1"
MATERIAL	steel
C	70 mm
RETENTION SYSTEM	n.a.



COMPATIBLE WITH F488

CODE	VERSION	DESCRIPTION
B.32.0018	LH - aerospace steel	with slots
B.32.0019	RH - aerospace steel	with slots

On demand we are able to produce and supply more wheel nuts for different specific needs.

INSERT ADAPTERS



Reccomended just for garage use.
With this compact insert adapter to a bigger square drive the overall length is reduced to an absolute minimum.
The insert adapter sticks to the socket by means of a magnet.

CODE	WHEEL GUN	SOCKETS
B.29.0001	1/2"	3/4"
B.29.0002	3/4"	1"



SOCKET RINGS & RETAINERS



WARNING!

The socket without the retainer can be dangerous if it gets out during the work!

FOR SQUARE DRIVE	RETAINER	RINGS
1/2"	B.30.01.0011	B.30.02.0001 (18 mm) B.30.02.0002 (24 mm)
3/4"	B.30.01.0010	B.30.02.0003 (38 mm)
1"	B.30.01.0009	B.30.02.0004 (45 mm)





FAST REVERSE DEVICES

Speed up your wheel gun direction-change



E-SHUTTLE

MECHATRONIC FAST SHUTTLE

The E-Shuttle is the first system which inverts the shuttle position from tightening to loosening automatically.

It is activated by an electronic lever with integrated led position.

The system is based on a latest generation electric actuator that guarantees a reversal in 15 hundredths of a second and allows to switch from loosening to tightening and reverse just by pushing a lever.

It is controlled by a leverage that can be placed by the user in a totally customized position to follow the desired ergonomics.

The entire system is controlled by an electronic circuit housed in the back cover which, thanks to a double independent circuit supply system, guarantees the success of the pit stop in any condition.

The E-Shuttle is powered by a voltage of 24 volts and 2 ampères but it is available to be connectable to any voltage requirement.

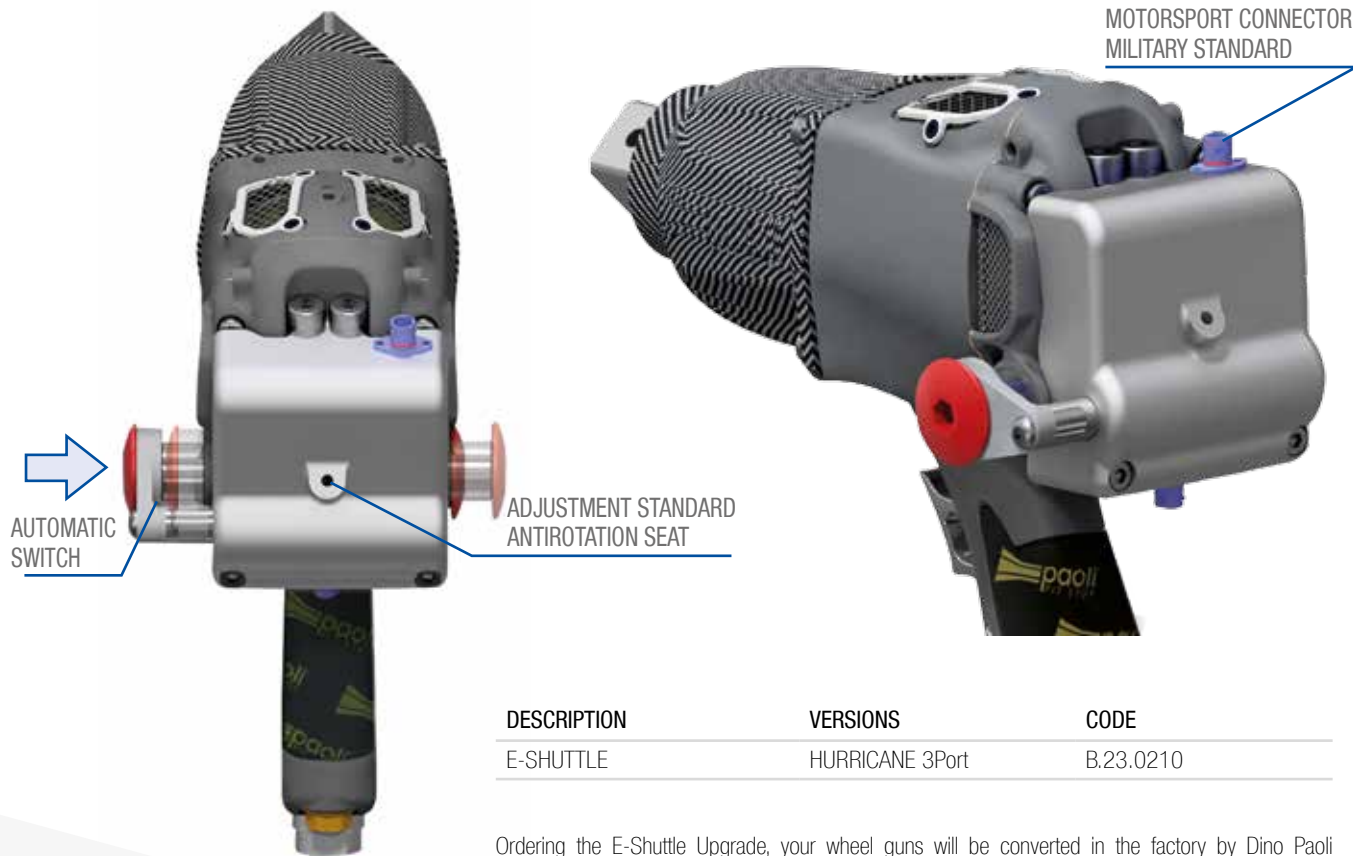
**DESCRIPTION**

E-SHUTTLE

VERSIONS

HURRICANE 3Port

CODE

B.23.0210

Ordering the E-Shuttle Upgrade, your wheel guns will be converted in the factory by Dino Paoli technicians.

The system is supplied as a stand alone add-on and can therefore be combined with the major Paoli wheel guns: Hurricane and DP 6000.



More about
E-SHUTTLE

FASTSHIFT



CODE	DESCRIPTION	APPLY ON
B.23.0187	LH 2-PORT BLUE	
B.23.0189	RH 2-PORT RED	HURRICANE
B.23.0188	LH 3-PORT BLUE	CLASSIC HANDLE
B.23.0190	RH 3-PORT RED	
B.23.0183	LH 2-PORT BLUE	
B.23.0185	RH 2-PORT RED	HURRICANE
B.23.0184	LH 3-PORT BLUE	90° ANGLED HANDLE
B.23.0186	RH 3-PORT RED	
B.23.0175	LH 2-PORT BLUE	
B.23.0179	RH 2-PORT RED	DP 6000
B.23.0177	LH 3-PORT BLUE	CLASSIC HANDLE
B.23.0181	RH 3-PORT RED	
B.23.0176	LH 2-PORT RED	
B.23.0180	RH 2-PORT RED	DP 6000
B.23.0178	LH 3-PORT BLUE	90° ANGLED HANDLE
B.23.0182	RH 3-PORT RED	



- Operator-controlled auto-reverse device
- Operator-friendly
- Increased speed of wheel gun direction-change
- Light weight: 430 grams

The Fastshift is an active system. So, to activate the inversion, it is sufficient to release the lever.

FAST SHUTTLE 2.0

PIT STOP COMPLETE DEVICE SUPPORT

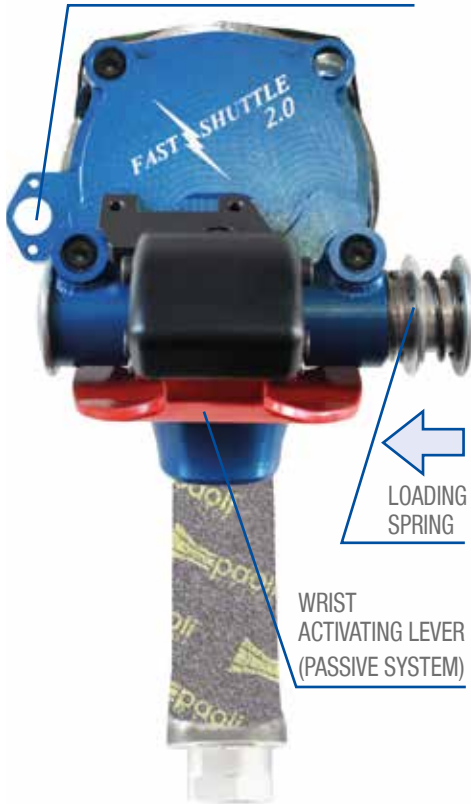

CODE	DESCRIPTION	APPLY ON
B.23.0136	LH 2-PORT BLUE	
B.23.0137	RH 2-PORT RED	DP 6000 DP 5000 TI MK II
B.23.0154	LH 3-PORT BLUE	DP 4000 MG
B.23.0155	RH 3-PORT RED	

Customized versions are available on demand.

Fast Shuttle 2.0 was designed to speed up the operator's reaction time when changing the direction.

Specifically, it works like the Fast Shuttle 1.0, but the activation needs to be executed through a wrist movement, instead of a thumb movement. The reaction time has been reduced by 80%.

An additional device for the "Pit Stop complete" button is available. The Pit Stop complete device support is suitable for the APEM 13000X778 button and Deutsch ASDD006-09PN connector.



FAST SHUTTLE



CODE	DESCRIPTION	APPLY ON
B.23.0105	LH 3-PORT BLUE	
B.23.0106	RH 3-PORT RED	DP 2000-S DP 4000 MG DP 5000 TI
B.23.0115	LH 2-PORT BLUE	
B.23.0116	RH 2-PORT RED	



The Fast Shuttle is an auto reverse shuttle that has got just an ON (loosening) and OFF (tightening) position.

The Fast Shuttle is operator friendly as it is able to increase the speed of each operation: in fact the operator has just to push a lever to get the ON (loosening) mode from the OFF (tightening) mode.

A close-up photograph of a Paoli wheel gun optional. The device is a dark-colored metal tool with a cylindrical body and a textured, ribbed wheel at the end. The brand name 'paoli' and 'MADE IN ITALY' are visible on the tool. The background is blurred, showing a workshop environment with a red and white striped object. The image is framed by white diagonal lines.

WHEEL GUN OPTIONALS

Enhance your Paoli guns



CLUTCH DEVICE

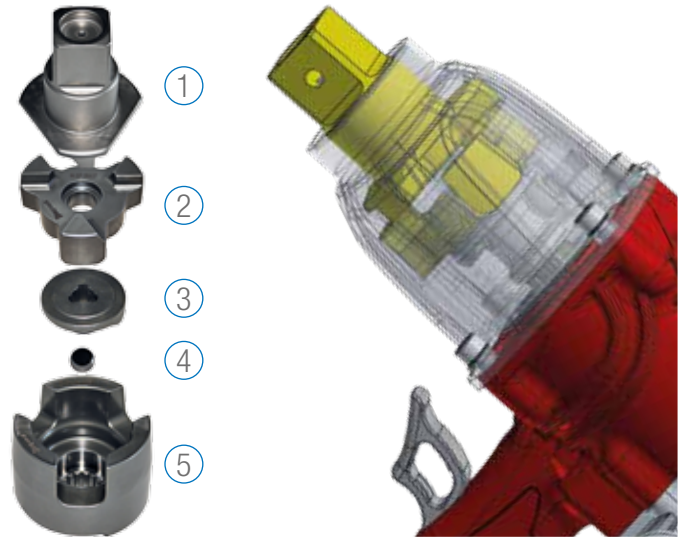

B.23.0166 LH VERSION

B.23.0167 RH VERSION

It reduces the power on tightening. The clutch device consists of:

- ① Anvil shank
- ② Clutch plate with 35° angled jaws
- ③ Cam clutch
- ④ Ball
- ⑤ Clutch housing

By replacing this parts you get a gun that is less powerful on tightening while the loosening power remains unchanged.

2-PORT BACK COVER KIT



B.23.0087

Available only for wheel guns DP 4000 MG, DP 4000 MG TSA, DP 4000 TS LAB, DP 4000 BIAS, DP 5000 TI, DP 5000 TI TSA.



Available for wheel guns DP 6000:

- LH Version: code B.23.0141
- RH Version: code B.23.0142
- UH Version: code B.23.0140

CARBON PEEK MOTOR VANES



B.23.0131

MORE DURABLE. After a test ran at 30 bar, we got a double life when compared to the normal carbon vanes.

MORE SMOOTHNESS. The carbon peek composite gets much less friction in the air motor.

Available for wheel guns DP 4000 BIAS, DP 4000, DP 3000, DP 2000 S, DP 2000 SE.

CARBON FRONT COVERS



Now with Zylon film built-in and Paoli logo. The Zylon coating prevents the splintering of the carbon cover increasing the operator safety. Screws and washers included.

CODE	APPLY ON
B.23.0121	DP 2000 SE, DP 3000, DP 4000, DP 4000 MG
B.23.0109	DP 5000, DP 6000, HURRICANE



FAST REVERSE SYSTEM



B.31.0001

Available only for DP 2000 S, DP 2000 SE, DP 197 SFE and DP 176 SFE.



B.31.0016



B.31.0017



B.31.0018

Available for DP 3000, DP 4000 MG, SUPERSPORT, DP 3000 SUPERSPORT, DP 4000 BIAS, DP 5000 BIAS, DP6000 BIAS, DP 5000 TI MARK II, DP 6000, BLUEDEVIL.



B.31.0009



B.31.0010



B.31.0013



B.31.0005
(B.31.0019 only for DP3000 SUPERSPORT)

Available only for wheel guns DP 3000, DP 4000 MG, BLUE DEVIL, SUPERSPORT, DP 4000 BIAS, DP 5000 TI MARK II, DP 5000 BIAS, DP 6000 BIAS, DP 6000, HURRICANE.

DOUBLE STAGE TRIGGER

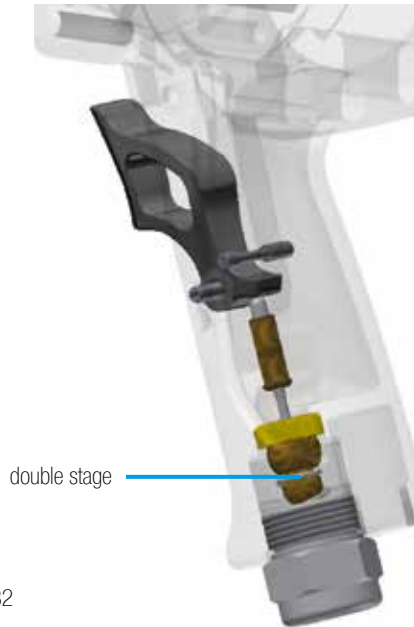

B.23.0132

This new system has been designed to act easily on the trigger even at very high pressures (over 25 bar).

AVAILABLE FOR:

- 5000 TI MARK II
- 5000 TI MARK II TSA
- 4000 MG (only for models from January 2015)

TRIGGERS



CODE	MATERIAL	AVAILABLE FOR
D.01.21.0028	Steel	6000 5000TI 5000TI-TSA 4000MG 4000MG-TSA 4000TS-LAB
D.01.21.0027	PA w/ glass fiber	6000 5000TI 5000TI-TSA 4000MG 4000MG-TSA 4000TS-LAB
D.01.21.0001	PA w/ glass fiber [standard]	4000BIAS 5000TI 5000TI-TSA 4000MG 4000MG-TSA 4000TS-LAB
D.01.21.0026	PA w/ carbon fiber	6000 5000TI 5000TI-TSA 4000MG 4000MG-TSA 4000TS-LAB

PAOLI DISPLAYERS

Demountable stand for Paoli wheel guns, air pressure regulators and accessories.

Easy to be disassembled.

Side panel graphics can be customized on request.



Brackets for Paoli air pressure regulators



B.26.0028



3/8" fittings for Paoli impact wrenches



It is on swivel wheels for easy transportation

PAOLI DISPLAYERS



B.26.0015

Table displayers made of steel for Paoli impact wrenches with quick release couplings included.

Models available:

- 1 position (B.26.0015)
- 3 positions (B.26.0009)
- 5 positions (B.26.0010)

WHEEL GUN BAGS



B.19.0011 BLACK



B.19.0010 RED



B.19.0009 BLUE

Made of technical fabric with polyethylene foam padding. Removable padding. Hand wash with soap and water (not washing machine).

- More colors available
- New design: more ergonomic!
- Each bag can contain: 2 wheel guns with sockets mounted on
- Tags available

COVERS



TRANSPARENT
PLASTIC COVER

AVAILABLE FOR	PRODUCT CODE
HURRICANE	B.18.0050
DP 6000 - DP 5000 TI - DP 4000 MG	B.18.0013
DP 5000 BIAS - DP 6000 BIAS	B.18.0043
DP 2000 S, SE	B.18.0000
DP 4000 BIAS	B.18.0024
SUPER SPORT	B.18.0023
DP 197 SFE	B.18.0001
DP 176 SFE - DP 177 SFE	B.18.0003
BLUE DEVIL	B.18.0019
DP 36 SF EVO - 4BIKE	B.18.0006
DP 5000 TI (with fast shuttle)	B.18.0030
DP 4000 MG (with fast shuttle)	
DP 5000 TI MARK II TSA (right led box)	B.18.0022
DP 4000 MG TSA (right led box)	
DP 5000 TI MARK II TSA (left led box)	B.18.0026
DP 4000 MG TSA (left led box)	
DP 4000 MG TS LAB (right led box)	B.18.0021
DP 4000 MG TS LAB (left led box)	B.18.0027



BALLISTIC
NYLON COVER

NEW LONGER VELCRO STRAP
TO CLOSE THE COVER

Technical fabric cover made of ballistic nylon.

- Strong and durable
- Thick and resistant
- New design
- Available in:



AVAILABLE FOR	PRODUCT CODE
	B.18.0047 black
HURRICANE	B.18.0048 red
	B.18.0049 blue
	B.18.0031 black
DP 6000 - DP 5000 TI - DP 4000 MG	B.18.0032 red
	B.18.0033 blue

Other models coming soon.

GRIP TAPES

NEW



B.23.0076



T.02.0023



T.02.0030



T.02.0022

PRODUCT CODE	DESCRIPTION
T.02.0030	Handle sticker for HURRICANE 90° ANGLED HANDLE, DP 6000 90° ANGLED HANDLE
T.02.0023	Handle sticker for HURRICANE 72° ANGLED HANDLE, DP 6000 72° ANGLED HANDLE, DP 5000 TI, DP 4000 MG, DP 2000 SE, SUPERSPORT, DP 197 SFE, DP 176 SFE
T.02.0022	Handle sticker for BLUE DEVIL, DP 36 SF EVO
B.23.0076	Grip Tape (15 m x 50 mm)



GP2 ART
09.2014

Paoli
PIT STOP
WE SERVED YOUR NEED
www.paolipitstop.com



AIR SUPPLY SYSTEM

Equipment for the maximum power





AIR SUPPLY SYSTEM



QUICK RELEASE COUPLINGS

92



AIR PRESSURE REGULATORS

102



TURNING CONNECTORS

99



AIR BOTTLES & TROLLEYS

115



HOSES

100



AIR BOTTLE COMPRESSORS

122

RECOMMENDED PAOLI PIT STOP SYSTEM

SUITABLE FOR: HURRICANE • DP 6000 • DP 6000 BIAS • DP 4000 MG • DP 4000 30BAR • DP 3000 SUPERSPORT • DP 2000 SE • DP 197 SFE • DP 177 SFE

1/2" FITTING

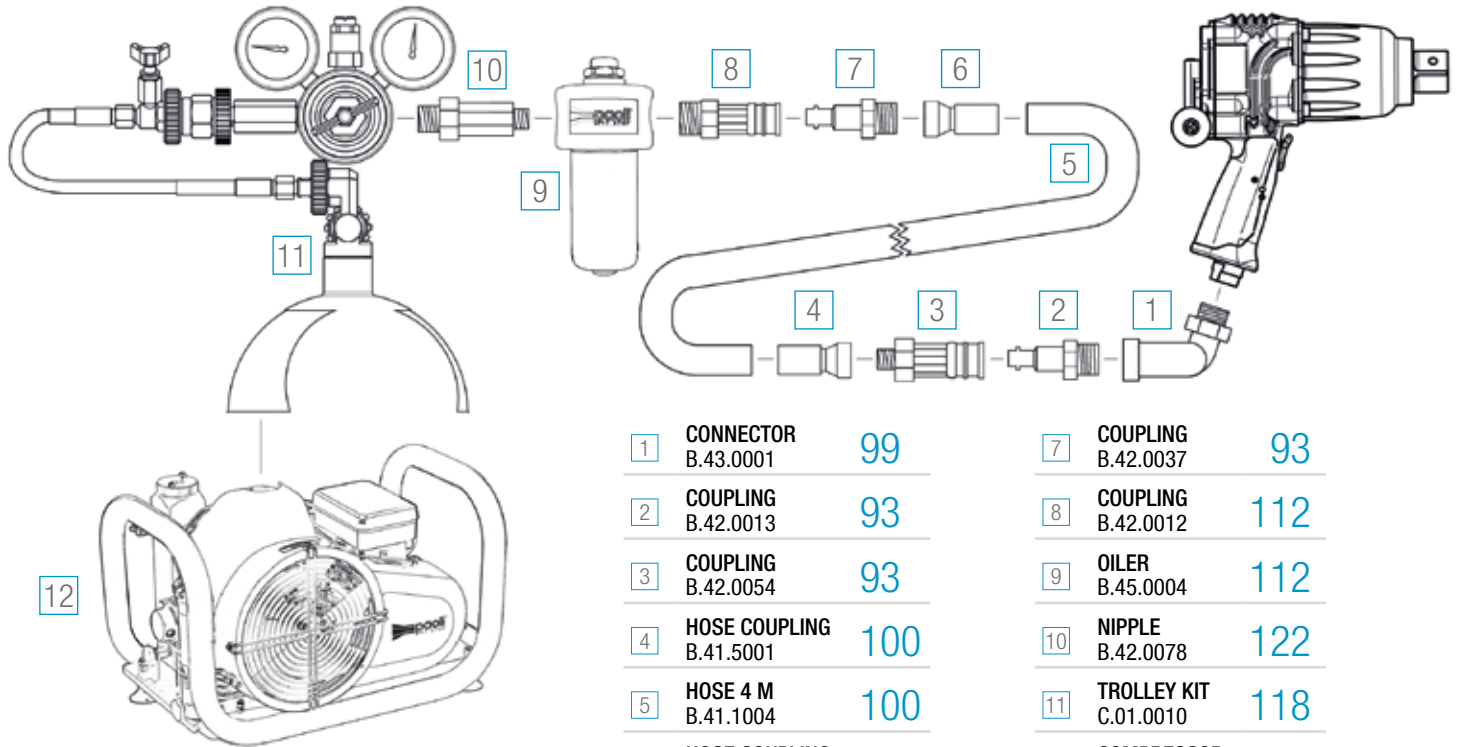

1	CONNECTOR B.43.0001	99	7	COUPLING B.42.0037	93
2	COUPLING B.42.0013	93	8	COUPLING B.42.0012	112
3	COUPLING B.42.0054	93	9	OILER B.45.0004	112
4	HOSE COUPLING B.41.5001	100	10	NIPPLE B.42.0078	122
5	HOSE 4 M B.41.1004	100	11	TROLLEY KIT C.01.0010	118
6	HOSE COUPLING B.41.5001	100	12	COMPRESSOR B.21.0102	123

RECOMMENDED PAOLI PIT STOP SYSTEM

SUITABLE FOR: DP 176 SFE • BLUE DEVIL • DP 36 SF EVO • 4BIKE

3/8" FITTING

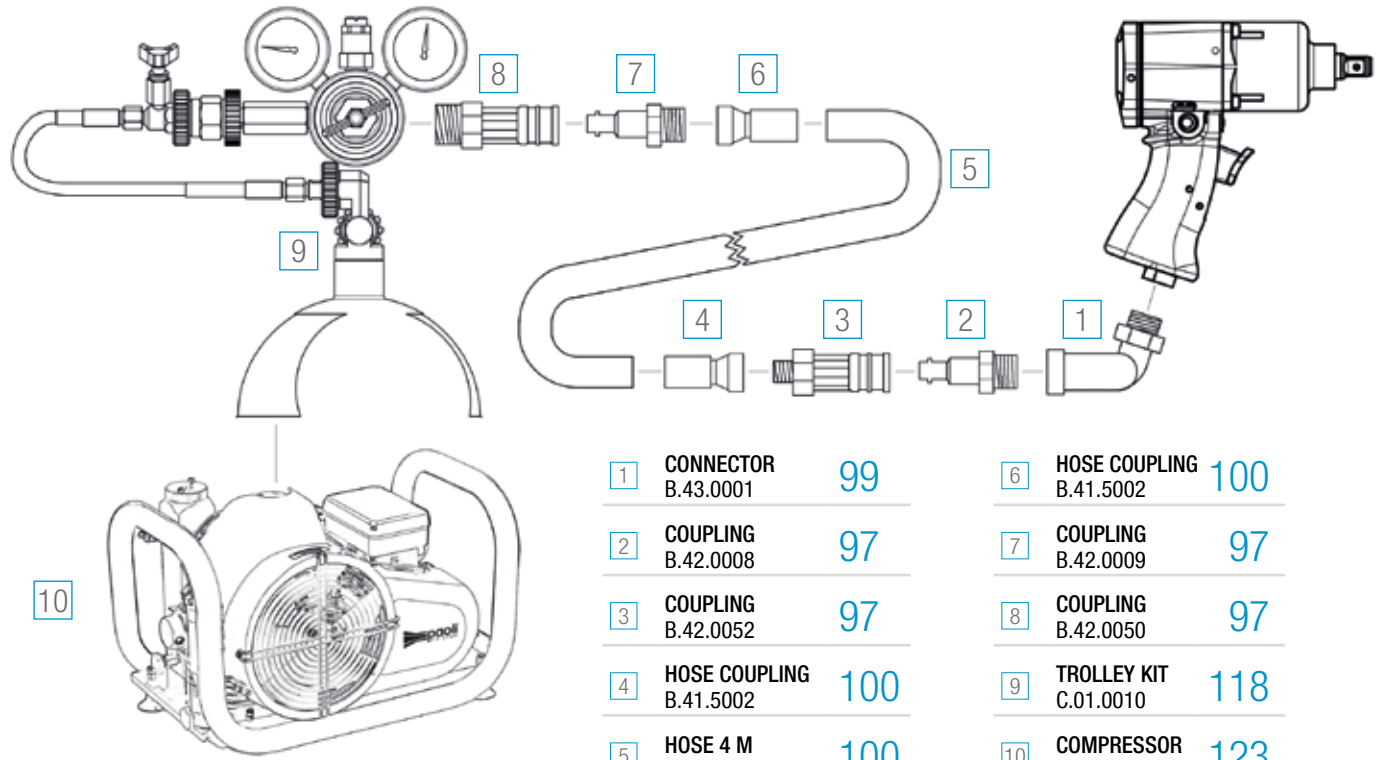

1	CONNECTOR B.43.0001	99	6	HOSE COUPLING B.41.5002	100
2	COUPLING B.42.0008	97	7	COUPLING B.42.0009	97
3	COUPLING B.42.0052	97	8	COUPLING B.42.0050	97
4	HOSE COUPLING B.41.5002	100	9	TROLLEY KIT C.01.0010	118
5	HOSE 4 M B.41.1004	100	10	COMPRESSOR B.21.0102	123

QUICK RELEASE COUPLINGS 1/2" (FOR HOSE THREADED 1/2" BSP)

SUITABLE FOR: HURRICANE • DP 6000 • DP 6000 BIAS • DP 4000 MG • DP 4000 30BAR • DP 3000 SUPERSPORT • DP 2000 SE • DP 197 SFE • DP 177 SFE

tst[®]EUROPE

SECURITY SYSTEM BY TST EUROPE

Safety Device.

Locking Pressure Series

PRODUCT CODE	INSIDE DIAMETER	THREAD
B.42.0015	11 mm (7/16")	3/8" bsp
B.42.0004	11 mm (7/16")	1/2" bsp
B.42.0016	11 mm (7/16")	1/2" bsp
B.42.0003	11 mm (7/16")	3/8" bsp

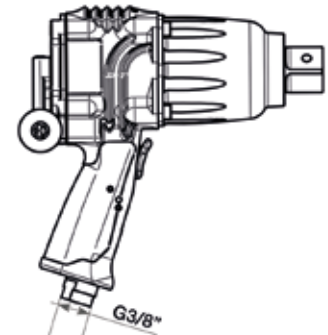
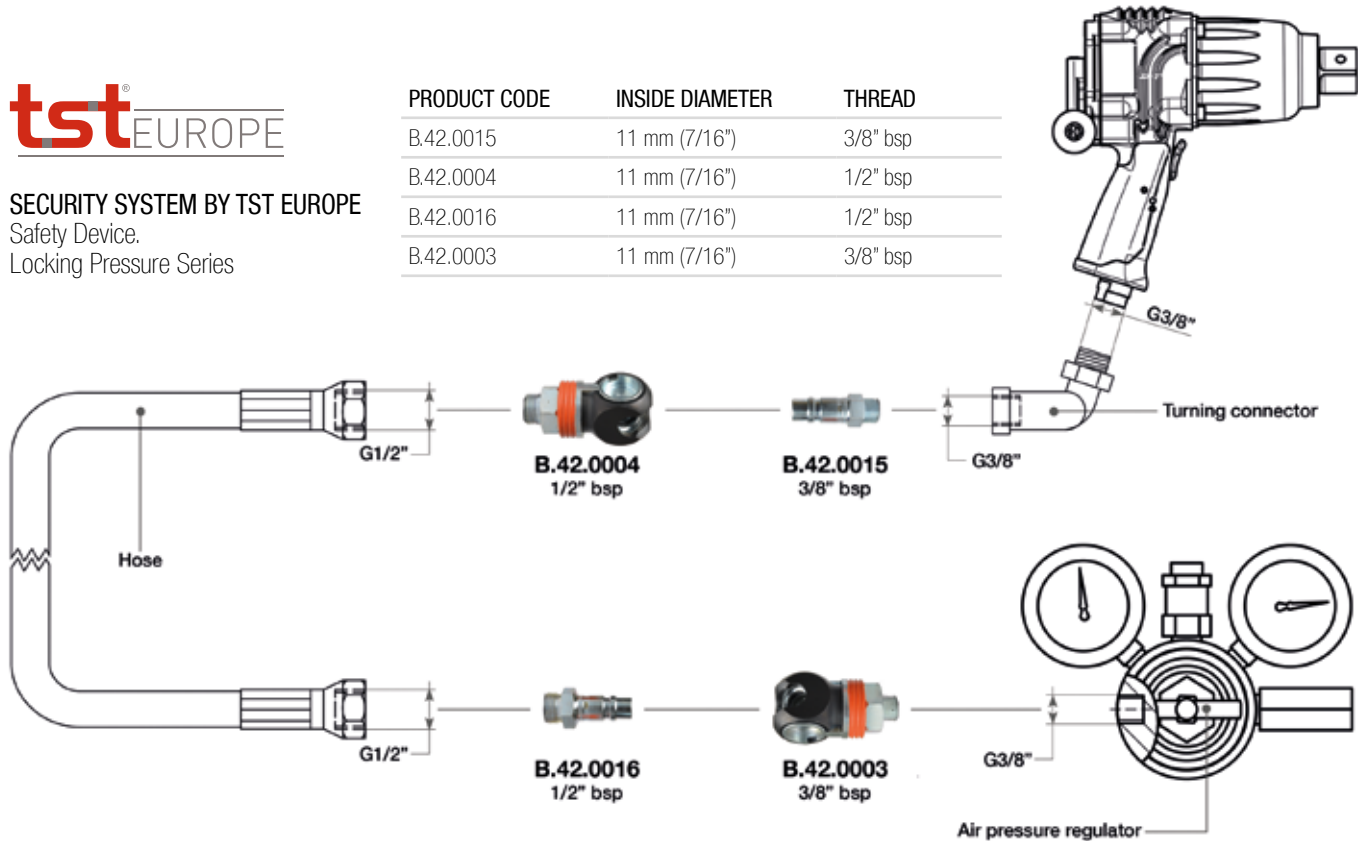

QUICK RELEASE COUPLINGS 1/2" (FOR HOSE THREADED 1/2" BSP)

SUITABLE FOR: HURRICANE • DP 6000 • DP 6000 BIAS • DP 4000 MG • DP 4000 30BAR • DP 3000 SUPERSPORT • DP 2000 SE • DP 197 SFE • DP 177 SFE



ESAFE SYSTEM - WITH SAFETY OUTLET

The new couplings eSafe by Cejn offer a higher flow, a compact design. They are extremely durable and easy to handle. They also have a function of safety outlet.

PRODUCT CODE	PRODUCT NAME	INSIDE DIAMETER	THREAD
B.42.0013	410-5154	10,4 mm (13/32")	3/8" bspt
B.42.0054		10,4 mm (13/32") ID 60°	1/2" bsp
B.42.0037	410-5265	10,4 mm (13/32") ID 60°	1/2" bsp
B.42.0056	410-2155	10,4 mm (13/32")	3/8" bspt

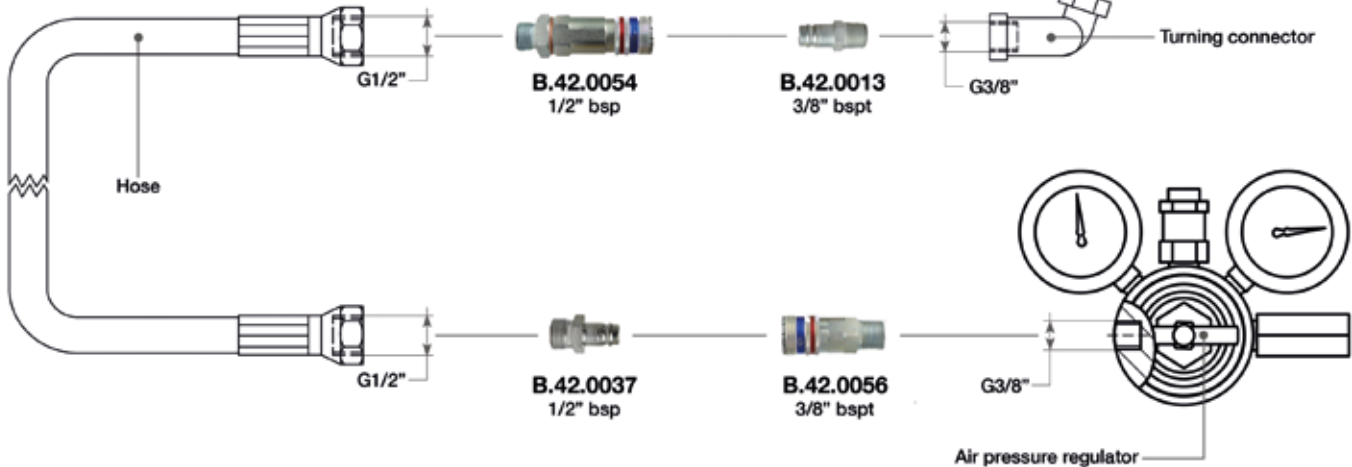

QUICK RELEASE COUPLINGS 1/2" (FOR HOSE THREADED 1/2" BSP)

SUITABLE FOR: HURRICANE • DP 6000 • DP 6000 BIAS • DP 4000 MG • DP 4000 30BAR • DP 3000 SUPERSPORT • DP 2000 SE • DP 197 SFE • DP 177 SFE



HIGH FLOW SERIES - EXTREME USE

Automatic safety-locking feature.
Extremely high flow capacity.
One-hand operated.

PRODUCT CODE	PRODUCT NAME	INSIDE DIAMETER	THREAD
B.42.0062	442-5154	10,4 mm (13/32")	3/8" bspt
B.42.0060		10,4 mm (13/32")	1/2" bsp
B.42.0075		10,4 mm (13/32")	1/2" bsp
B.42.0058	442-1154	10,4 mm (13/32")	3/8" bspt

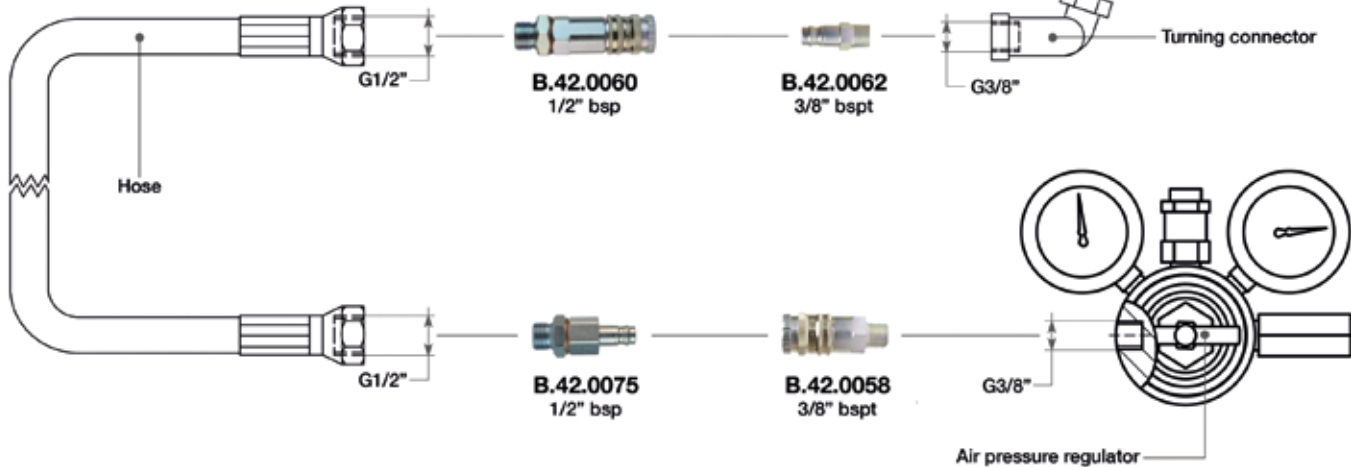
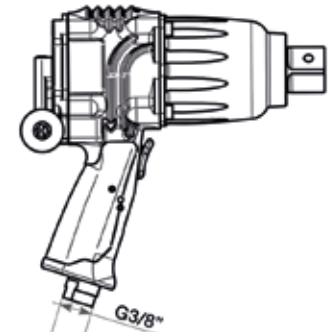

NEW

UPDATED AND MORE PERFORMANT VERSION!
NOW UP TO 30 BAR RESISTANT.

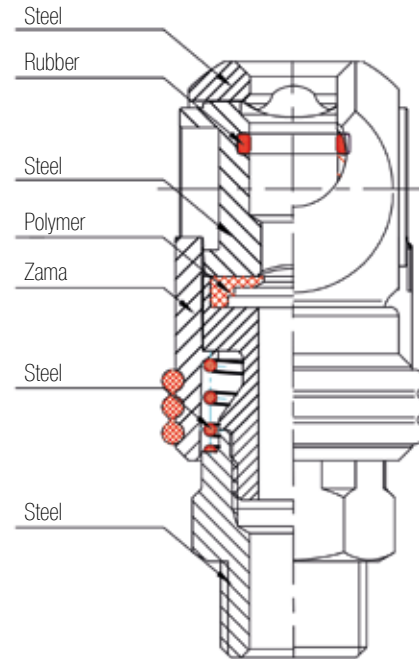

QUICK RELEASE COUPLINGS 3/8" (FOR HOSE THREADED 3/8" BSP)

SUITABLE FOR: DP 176 SFE • BLUE DEVIL • DP 36 SF EVO • 4BIKE

tst EUROPE

SECURITY SYSTEM BY TST EUROPE
Safety Device.
Locking Pressure Series

PRODUCT CODE	INSIDE DIAMETER	THREAD
B.42.0008	7,6 mm (19/64")	3/8" bspt
B.42.0001	8 mm (5/16")	3/8" bsp
B.42.0009	7,6 mm (19/64") ID 60°	3/8" bsp
B.42.0001	8 mm (5/16")	3/8" bsp

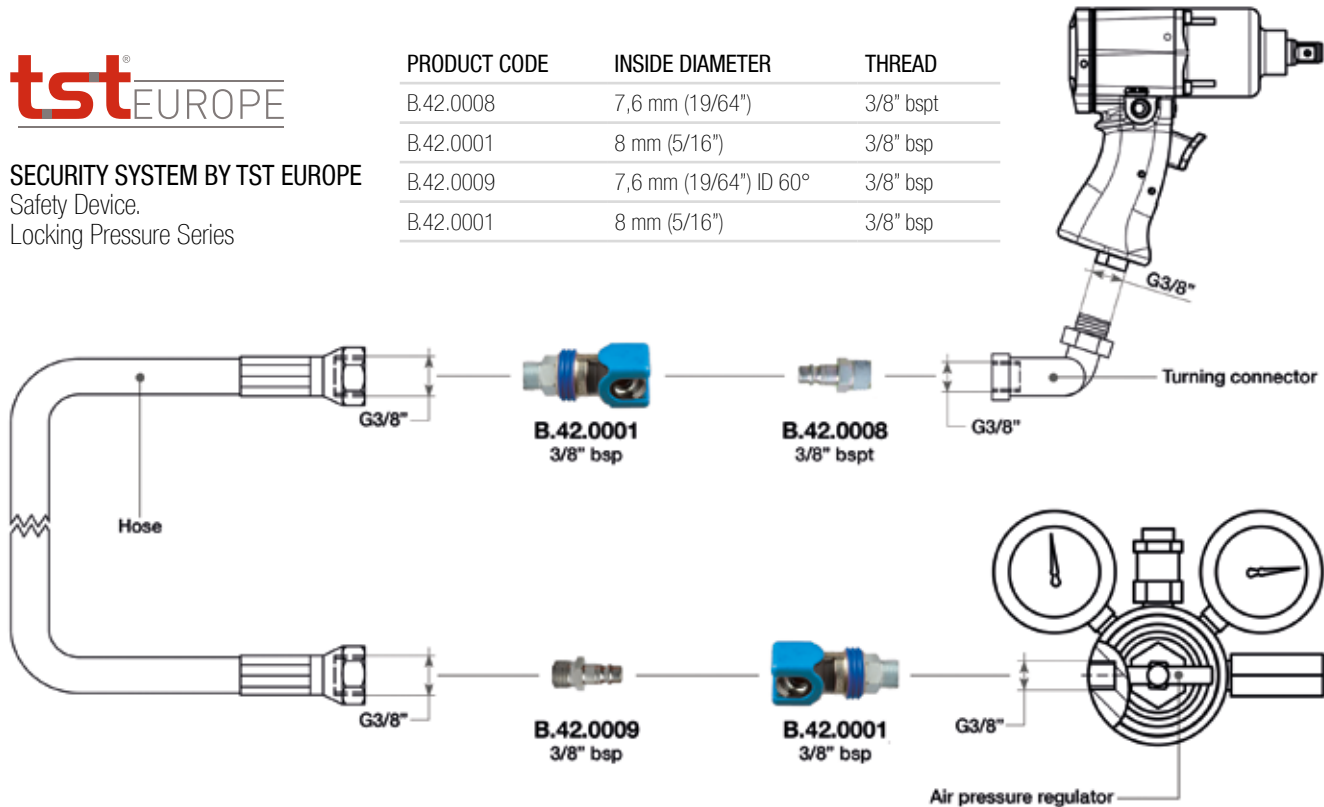

QUICK RELEASE COUPLINGS 3/8" (FOR HOSE THREADED 3/8" BSP)

SUITABLE FOR: DP 176 SFE • BLUE DEVIL • DP 36 SF EVO • 4BIKE



ESAFE SYSTEM - WITH SAFETY OUTLET

The new couplings eSafe by Cejn offer a higher flow, a compact design. They are extremely durable and easy to handle. They also have a function of safety outlet.

PRODUCT CODE	PRODUCT NAME	INSIDE DIAMETER	THREAD
B.42.0008	320-5154	7,6 mm (19/64")	3/8" bspt
B.42.0052	320-2204	7,6 mm (19/64") ID 60°	3/8" bsp
B.42.0009	320-5264	7,6 mm (19/64") ID 60°	3/8" bsp
B.42.0050	320-2154	7,6 mm (19/64")	3/8" bspt

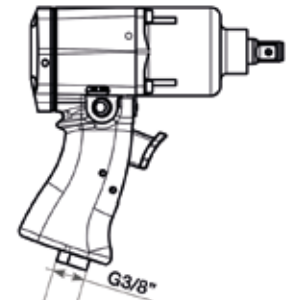
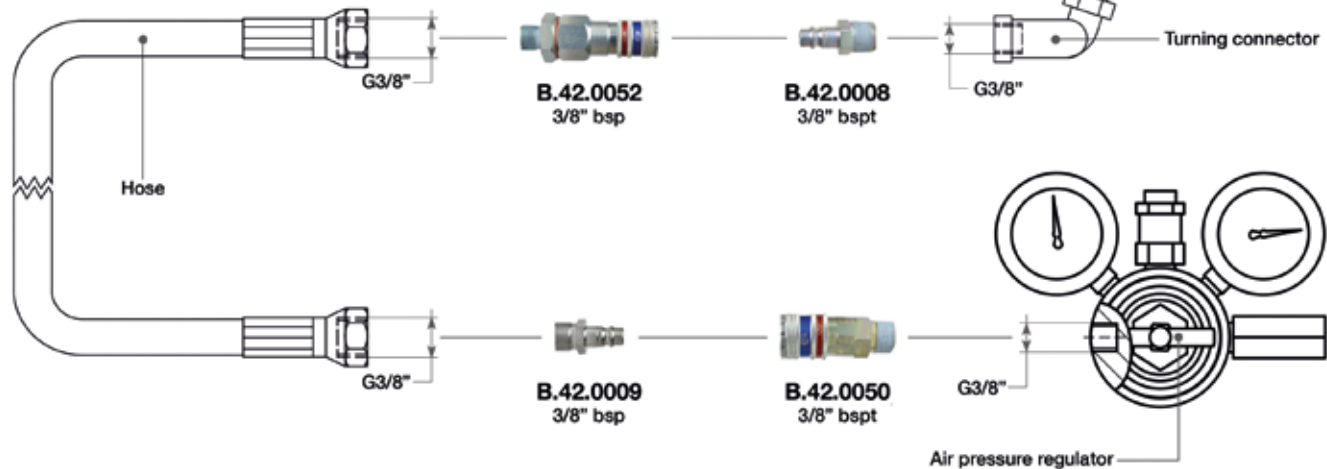

QUICK RELEASE COUPLINGS 3/8" (FOR HOSE THREADED 3/8" BSP)

SUITABLE FOR: DP 176 SFE • BLUE DEVIL • DP 36 SF EVO • 4BIKE



HIGH FLOW SERIES - EXTREME USE

Automatic safety-locking feature.
Extremely high flow capacity.
One-hand operated.

PRODUCT CODE	PRODUCT NAME	INSIDE DIAMETER	THREAD
B.42.0062	442-5154	10,4 mm (13/32")	3/8" bspt
B.42.0059		10,4 mm (13/32") ID 60°	3/8" bsp
B.42.0076		10,4 mm (13/32")	3/8" bspt
B.42.0058	442-1154	10,4 mm (13/32")	3/8" bspt

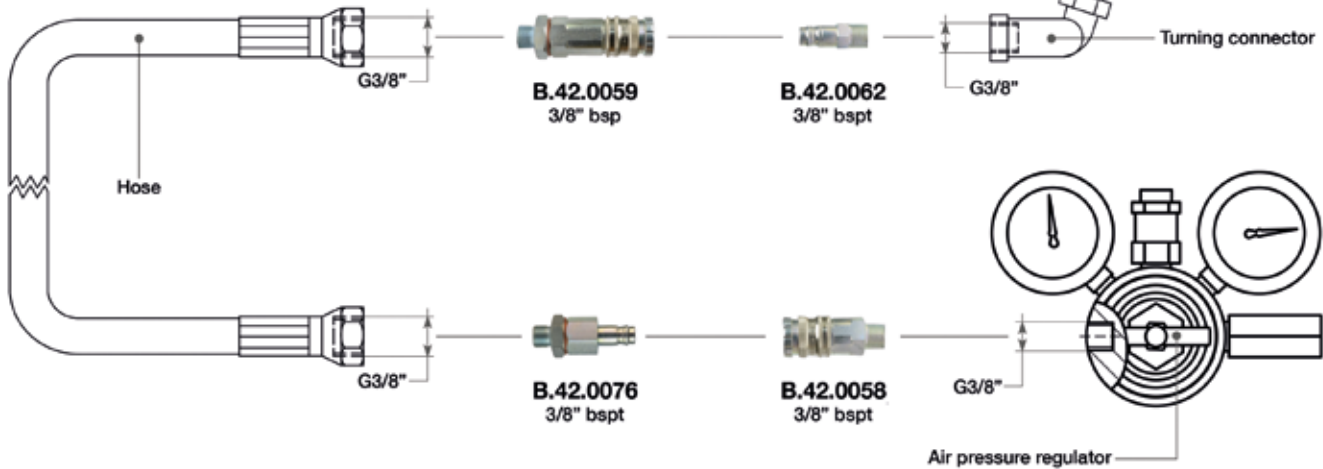
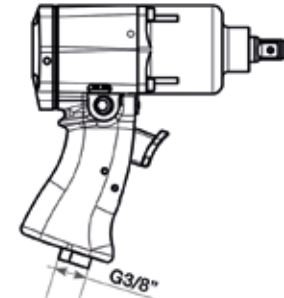

TURNING CONNECTORS



A

TYPE R

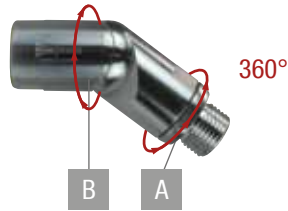

B

A

TYPE D

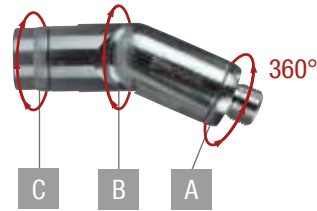

C

B

A

TYPE D3



	PRODUCT NAME	PRODUCT CODE	MALE/FEMALE	INSIDE DIAMETER	TURNING	FLEXING HOSE CONNECTOR	TURNING
TYPE D	DV11MFG38	B.43.0001	3/8" BSP	11 mm	360°	90°	
	DV7MFN14	B.43.0004	1/4" NPT	7 mm	360°	90°	
	DV11MFG12	B.43.0007	1/2" BSP	11 mm	360°	90°	
TYPE R	RV11MFB38	B.43.0003	3/8" BSP	11 mm	360°	--	
	RV11MFB12	B.43.0011	1/2" BSP	11 mm	360°	--	--
TYPE D3	DV11MFB38-3R	B.43.0002	3/8" BSP	11 mm	360°	90°	360°
	DV11MFB12-3R	B.43.0041	1/2" BSP	11 mm	360°	90°	360°

HOSES

75 BAR HOSE

Technical data - bore size: 13 mm, braid od: 23,5 mm, working pressure: 75 bar.

A - SELECT LENGTH

CODE	LENGTH	CODE	LENGTH
B.41.1001	1 m	B.41.1006	6 m
B.41.1002	2 m	B.41.1007	7 m
B.41.1003	3 m	B.41.1008	8 m
B.41.1004	4 m	B.41.1009	9 m
B.41.1005	5 m	B.41.1010	10 m

B, C - SELECT COUPLINGS

	ANGLE	1/2"	3/8"	NPT 3/8
	0°	B.41.5001	B.41.5002	B.41.5003
Female	45°	B.41.5004	B.41.5005	
	90°	B.41.5007	B.41.5008	
Male	0°	B.41.5010	B.41.5011	

50 BAR HOSE

Technical data - bore size: 10 mm, braid od: 19 mm, working pressure: 50 bar.

A - SELECT LENGTH

CODE	LENGTH	CODE	LENGTH
B.41.2001	1 m	B.41.2006	6 m
B.41.2002	2 m	B.41.2007	7 m
B.41.2003	3 m	B.41.2008	8 m
B.41.2004	4 m	B.41.2009	9 m
B.41.2005	5 m	B.41.2010	10 m

B, C - SELECT COUPLINGS

	ANGLE	1/2"	3/8"	NPT 3/8
	0°	B.41.8001	B.41.8002	
Female	45°		B.41.8005	
	90°		B.41.8008	
Male	0°		B.41.8011	B.41.8020
	45°			B.41.8021
	90°			B.41.8022



HOW TO ORDER

- 1 select the length of the hose (table A)
- 2 select the fittings at both ends of the hose (table B/C)

More items and configurations on demand.

WHIP HOSES



WH3C - B.20.01.0007
Whip Hose w/D3 Turning Connector



WHSC - B.20.01.0002
Whip Hose w/Swivel Fitting



WHTC - B.20.01.0001
Whip Hose w/360° Turning Connector

PRODUCT NAME	PRODUCT CODE	INSIDE DIAMETER	OUTSIDE DIAMETER	LENGTH		CONNECTION SIDE 1	CONNECTION SIDE 2	
WHTC	B.20.01.0001	13 mm	23,5 mm	18" (46 cm)	3/8" BSP	B.43.0001	B.41.0003	female
WHSC	B.20.01.0002	13 mm	23,5 mm	18" (46 cm)	3/8" BSP	B.43.0003	B.41.0003	female
WH3C	B.20.01.0007	13 mm	23,5 mm	18" (46 cm)	3/8" BSP	B.43.0003	B.41.0003	female

PAOLI REGULATORS

AIR PRESSURE REGULATORS

Main features: Paoli regulators have all been conceived to first guarantee the correct (very high) air flow to all the models of Paoli guns. Furthermore, all the Paoli regulators minimize the pressure drop from static to dynamic. We do deliver mostly piston regulators for high pressure and diaphragm regulators for lower pressures.

- All of our regs are entirely made of brass
- We can deliver different kind of gauges (standard, filled w/vaseline to stabilize the needle, w/double main scale psi/bar)
- We do always recommend to match a high pressure oiler to each regulator and to ship them back regularly to us or to an authorized service centre for a complete overhaul.

F4 FEATURES



- The “Paoli F4” air pressure regulator is the best seller model. It keeps high performances also when the bottle is almost empty. Max air flow superior to any other air pressure regulator!
- It grants constant air flow also at high pressures.
- It keeps high performances also when the air bottle is half empty.
- It gives very high air flow



Operating and maintenance manual

**AIR PRESSURE
REGULATORS**



MODEL F1



PISTON MECHANISM

CODE	B.40.0001	B.40.0034	B.40.0040
INLET PRESSURE	220 bar	220 bar	350 bar
MAX FLOW (20 BAR/OUT)	150 Nm ³ /h	150 Nm ³ /h	200 Nm ³ /h
GAUGES IN	0-450 bar	0-6500 PSI	0-450 bar
GAUGES OUT	0-100 bar	0-870 PSI	0-60 bar
OVER PRESSURE VALVE SETTING	30 bar	30 bar	30 bar
THREAD IN	1/4" BSP	1/4" BSP	1/4" BSP
THREAD OUT	3/8" BSP	3/8" BSP	3/8" BSP
FLOW	medium	medium	medium
AIRJACK			
HIGH FLOW FILTER			
BALANCED			

MODEL F2



PISTON MECHANISM

CODE	B.40.0002	B.40.0035	B.40.0041
INLET PRESSURE	220 bar	220 bar	350 bar
MAX FLOW (20 BAR/OUT)	150 Nm ³ /h	150 Nm ³ /h	200 Nm ³ /h
GAUGES IN	0-450 bar	0-6500 PSI	0-450 bar
GAUGES OUT	0-100 bar	0-870 PSI	0-100 bar
OVER PRESSURE VALVE SETTING	50 bar	50 bar	50 bar
THREAD IN	1/4" BSP	1/4" BSP	1/4" BSP
THREAD OUT	3/8" BSP	3/8" BSP	3/8" BSP
FLOW	medium	medium	medium
AIRJACK	•	•	
HIGH FLOW FILTER			
BALANCED			

MODEL F4



PISTON MECHANISM

CODE	B.40.0005	B.40.0030	B.40.0042
INLET PRESSURE	220 bar	220 bar	350 bar
MAX FLOW (20 BAR/OUT)	400 Nm ³ /h	400 Nm ³ /h	500 Nm ³ /h
GAUGES IN	0-450 bar	0-6500 PSI	0-450 bar
GAUGES OUT	0-100 bar	0-870 PSI	0-100 bar
OVER PRESSURE VALVE SETTING	50 bar	50 bar	50 bar
THREAD IN	1/4" BSP	1/4" BSP	1/4" BSP
THREAD OUT	3/8" BSP	3/8" BSP	3/8" BSP
FLOW	high	high	high
AIRJACK	•	•	•
HIGH FLOW FILTER	•	•	•
BALANCED	•	•	•

MODEL F9

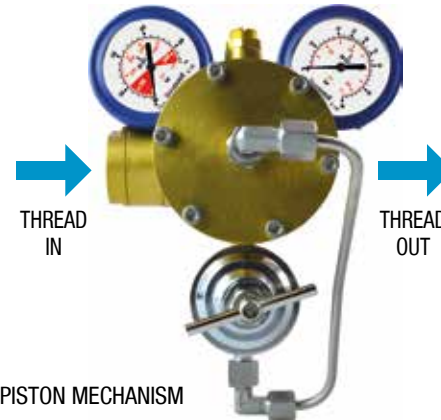

PISTON MECHANISM

CODE	B.40.0006	B.40.0033
INLET PRESSURE	220 bar	220 bar
MAX FLOW (20 BAR/OUT)	400 Nm ³ /h	400 Nm ³ /h
GAUGES IN	0-450 bar	0-6500 PSI
GAUGES OUT	0-60 bar	0-870 PSI
OVER PRESSURE VALVE SETTING	40 bar	40 bar
THREAD IN	1/4" BSP	1/4" BSP
THREAD OUT	3/8" BSP	3/8" BSP
FLOW	high	high
AIRJACK		
HIGH FLOW FILTER	•	•
BALANCED	•	•

MODEL F15

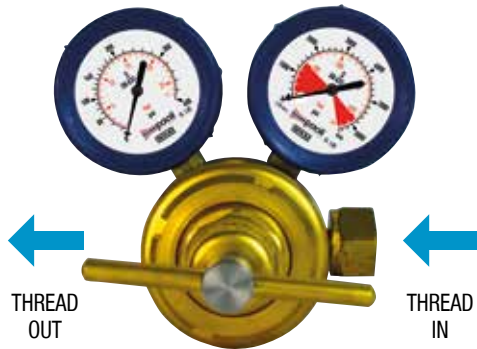

DIAPHRAGM MECHANISM

CODE	B.40.0048
INLET PRESSURE	300 bar
MAX FLOW (20 BAR/OUT)	500 Nm ³ /h
GAUGES IN	0-6500 PSI
GAUGES OUT	0-400 PSI
OVER PRESSURE VALVE SETTING	15 bar
THREAD IN	1/4" BSP
THREAD OUT	1/2" BSPT
FLOW	high
AIRJACK	
HIGH FLOW FILTER	
BALANCED	

MODEL F40

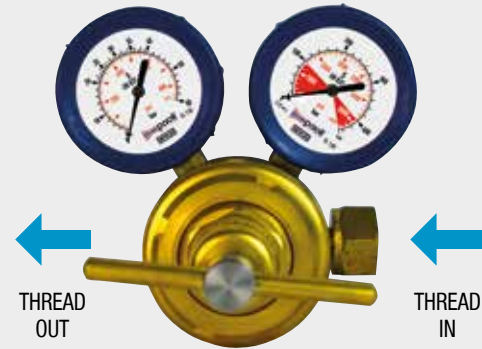

DIAPHRAGM MECHANISM

CODE	B.40.0049
INLET PRESSURE	300 bar
MAX FLOW (20 BAR/OUT)	700 Nm ³ /h
GAUGES IN	0-450 bar
GAUGES OUT	0-60 bar
OVER PRESSURE VALVE SETTING	40 bar
THREAD IN	1/4" BSP
THREAD OUT	1/2" BSPT
FLOW	high
AIRJACK	•
HIGH FLOW FILTER	
BALANCED	

MODEL F50



DIAPHRAGM MECHANISM

CODE	B.40.0077
INLET PRESSURE	300 bar
MAX FLOW (20 BAR/OUT)	~400 Nm ³ /h
GAUGES IN	0-450 bar
GAUGES OUT	0-100 bar
OVER PRESSURE VALVE SETTING	55 bar
THREAD IN	1/4" GAS F
THREAD OUT	1/2" Gas M
FLOW	high
AIRJACK	
HIGH FLOW FILTER	
BALANCED	•

AIR PRESSURE REGULATOR SERVICE FIXTURE



S.01.0161

The air pressure regulator service fixture sustains the regulator during its assembling and disassembling phases. It is compatible with the following Paoli air pressure regulator models: F1, F2, F4, F9 and F50.



AIR PRESSURE REGULATOR TESTING BENCH



B.23.0171

This kit has been designed to test the air pressure regulators. The air pressure regulator testing bench is composed by:

- 1 bench (350 x 130 x 80 mm)
- 1 hose
- 1 valve

DIN 200 Bar coupling for compressor available on demand (Code: B.21.0088)

SPARE GUN AIR SUPPLY DEVICE



B.42.0073

This device allows the operator to get a second spare gun connected to the same air supply.

It is needed in case of EMERGENCY (first gun failing) during the pit stop operations.

WARNING: you should use just on gun at a time otherwise the air flow drops down very quickly.

Couplings not included.



FIXING NUTS



B.40.0007

Fixing nuts for air pressure regulators
F1 - F2 - F4



ANALOGIC GAUGES



B.40.0071



B.40.0072



B.40.0073



B.40.0074



B.40.0075



B.40.0076

CODE	DIAMETER	CONNECTION	RANGE	GLYCERIN	DISPLAY
B.40.0071	63 mm	1/4" BSP	0-450 bar 0-6500 PSI	X	analogic
B.40.0072	63 mm	1/4" BSP	0-6500 PSI 0-450 bar	X	analogic
B.40.0073	63 mm	1/4" BSP	0-60 bar 0-870 PSI	X	analogic
B.40.0074	63 mm	1/4" BSP	0-100 bar 0-1450 PSI	X	analogic
B.40.0075	63 mm	1/4" BSP	0-400 PSI 0-28 bar	X	analogic
B.40.0076	63 mm	1/4" BSP	0-870 PSI 0-60 bar	X	analogic



paoli
PIT STOP



BACKLIGHTING:
the display can be easily read, even under poor lighting conditions.

ROTATABILITY OF THE DISPLAY:
The display can be rotated through 300°, thus it can be read from almost any position. Therefore the gauge can also be used in situations where mounting is difficult.

PRECISE AND QUICK READING OF THE DISPLAY

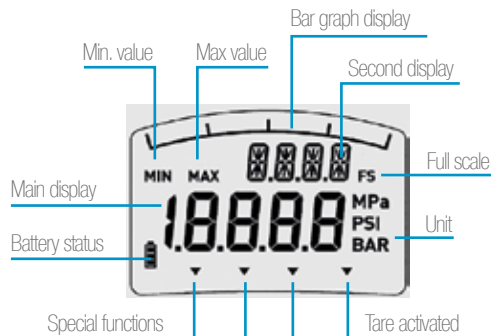

The robust stainless steel case and the battery power enable a flexible operation of the digital gauge. For a precise and quick on-site reading of a pressure value, a digital indicator is the ideal solution. The bargraph display and drag pointer function integrated into the display, as well as retrievable Min/Max peak values, enable effective analysis of the measuring point.

Thanks to the rotatable display, the digital pressure gauge can be easily adapted to difficult conditions. The backlighting also provides easy readability of the display in poor lighting conditions.

FEATURES

- Battery operation (2 x 1.5 V AA cell)
- Min/Max memory function
- Unit switching: bar, psi, MPa
- Accuracy 0.5 % ± 1 digit

CODE	DIAMETER	CONNECTION	RANGE	DISPLAY
B.40.0085	80 mm	1/4" BSP	0-100 bar 0-1500 PSI	digital
B.40.0086	80 mm	1/4" BSP	0-600 bar 0-8700 PSI	digital

HIGH PRESSURE OILER



B.45.0004



Inlet and outlet
reducer 3/4" to 1/2"
D.04.06.0037

New high pressure oiler with adjusting system and with sight glass to check the oil drops.

B.45.0003

More speed and performance, increased lifing of your Paoli gun.

The oiler constantly lubricates the air motor getting the maximum speed and increasing its reliability.

	B.45.0004	B.45.0003
MAX OPERATING PRESSURE	50 bar	25 bar
EFFECTIVE BOWL VOLUME	200 cm ³	135 cm ³
SIZE	1/2" BSP	3/4" BSP
MOUNTING POSITION	Vertical	Vertical
BOWL MATERIAL	AISI 316	Metal

ACCESSORIES

The following accessories are essential to assemble the oiler:



NIPPLE
Product Code B.42.0078



COUPLING
Product Code B.42.0012

HIGH FLOW FILTER



B.45.0005

HIGH FLOW FILTER FOR AIR PRESSURE REGULATOR KIT

Suitable for air pressure regulators for heavy duty application.

High surface area to grant bigger air flow.

Easy maintenance service.

Technical Data:

Thread IN: 1/4" BSP female

Thread OUT: 3/8" BSP male



AIR BOTTLE CONNECTORS

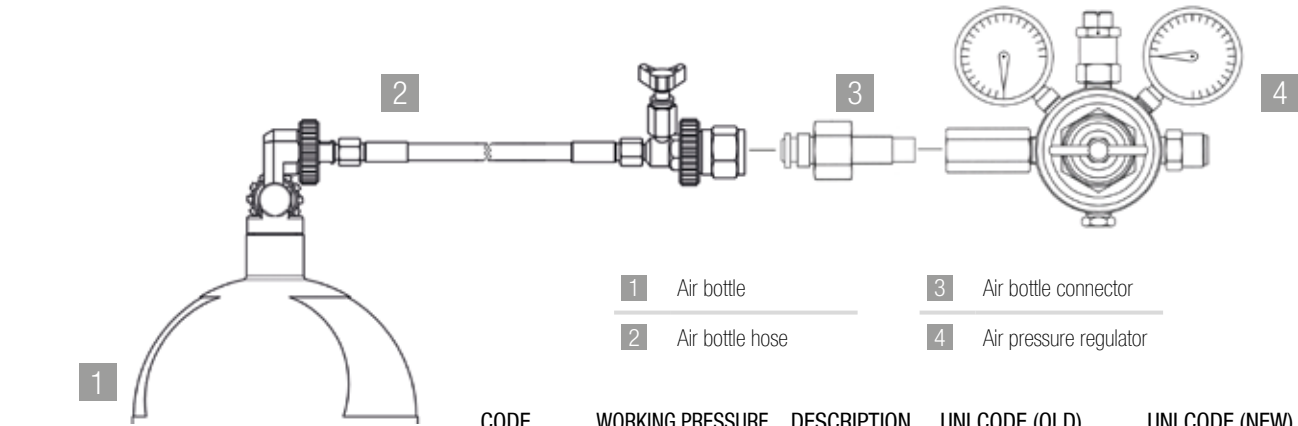

1 Air bottle

2 Air bottle hose

3 Air bottle connector

4 Air pressure regulator



B.01.0002



B.01.0006



B.01.0011



B.01.0007



B.01.0013



B.01.0017

CODE	WORKING PRESSURE	DESCRIPTION	UNI CODE (OLD)	UNI CODE (NEW)
B.01.0001	220 bar	COD-BSP		BS341 NR3
B.01.0002	220 bar	COD-D		DIN 477-13
B.01.0003	220 bar	COD-FR-J	ex UNI 4406 02	UNI 11144 NR2
B.01.0004	220 bar	COD-FR-N2		NF E29-650
B.01.0005	220 bar	COD-IT	ex UNI 4410 AIR	UNI 11144 NR6
B.01.0006	220 bar	COD-N2	ex UNI 4409 N2	UNI 11144 NR5
B.01.0007	220 bar	COD-US	ex UNI 4412 AR-HE	UNI 11144 NR8
B.01.0011	220 bar	COD-J	JAPAN	
B.01.0014	220 bar	COD-IN	INDIAN STANDARD	3224 2002
B.01.0013	220 bar	COD-CN	CHINA	N2 G5/8"
B.01.0016	220 bar	CGA580	use with F1, F2, F4, F9	
B.01.0017	220 bar	CGA580	use with F6, F7	
B.01.0027	300 bar	DIN 300	with pin	

BOTTLE CONNECTION SUPPORT



B.40.0008

This support connects the air bottle connector to the air pressure regulator. Suitable for F1 and F2 air pressure regulators.

Technical Data:

Thread IN: 1/4" BSP female

Thread OUT: 3/8" BSP male

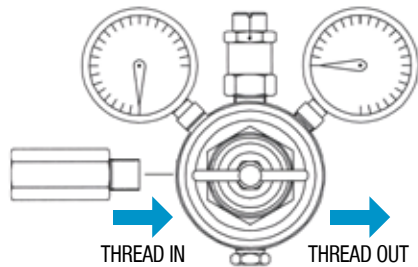

ADAPTERS



B.40.0056

NEW ADAPTER FOR PRESSURE REGULATORS

New adapter for air pressure regulators F40 and F15.

Technical Data:

Thread IN: 1/4" BSP female

Thread OUT: M15x1 male

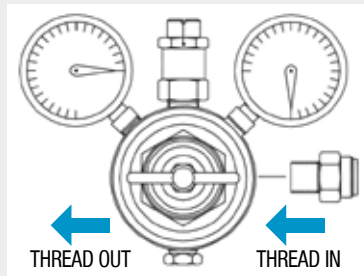

AIR BOTTLE COVERS



B.22.05.0000

AIR BOTTLE COVER FOR PAOLI AIR BOTTLES

- Black textile cover
- Available for 18 litres air bottles
- New design

AIR BOTTLES



COMPOSITE AIR BOTTLE WITH CARBON FIBER

Capacity: 9 liters

Max pressure at 15° C: 300 bar

Air bottles available versions:

- single connection (B.22.01.00.12)
- double connection (B.22.01.00.13)

Air bottle valves M18x1,5:

- single connection (B.22.04.0007)
- double connection (B.22.04.0008)

SINGLE INLET BOTTLE



B.22.01.0000
B.22.01.0002

DOUBLE INLET BOTTLE



B.22.01.0003
B.22.01.0001



C.01.0009

MOBILE AIR BOTTLE

Ideal to restore the tire pressure.

Equipped with: pressure gauge, air pressure regulator, hooking system on the belt.

PRODUCT CODE	CAPACITY (LITRES)	PRESSURE (BAR)	CONNECTION	CONNECTION TYPE
B.22.01.0000	15	232	Single	INT - Female / DIN - Male
B.22.01.0003*	15	232	Double	INT - Female / DIN - Male
B.22.01.0002**	18	220	Single	INT - Female / DIN - Male
B.22.01.0001**	18	220	Double	INT - Female / DIN - Male
C.01.0009	1	200		

* Suggested in order to avoid to dismount the air pressure regulator while recharging the bottle

** Just on demand

AIR BOTTLE TROLLEYS



The single trolley can be converted in double trolley



The double trolley can be converted in single trolley

- Just one trolley capable to carry the 15 or the 18 litres bottles.
- The trolley has got a support specifically designed for the PAOLI PIT STOP® Regulators F1, F2, F4.
- Two brackets designed to roll and easily carry the supply hose.

AIR BOTTLE TROLLEY KIT included



Accessories included: belt, fixing nut and high pressure hose to connect the air bottle to the air pressure regulator.

C.01.0003 Single

C.01.0002 Double

PRODUCT CODE	OVERALL DIMENSIONS	WEIGHT (W/O BOTTLE AND REGULATOR)	WEIGHT (WITH BOTTLE AND REGULATOR)
C.01.0003	47,3 x 39,5 x 116 cm	10,1 kg	36,6 kg
C.01.0002	47,3 x 65 x 116 cm	18 kg	71 kg

DOUBLE TROLLEY KIT

Extra-strong micropallinated stainless steel chassis

Double connection bottles for easy filling

High pressure hose to connect the air bottle to the air pressure regulator.

C.01.0011

The kit includes:

- No. 1 double trolley
- No. 2 1.8 litres bottles with double connection
- No. 2 air bottle trolley kit
- No. 1 F4 air pressure regulator (DIN air bottle connector included)

Also available with 2 F4 air pressure regulators (code C.01.0013).



The air pressure regulator is protected by a roll-bar

Wheel gun holder

Hose holder

Large diameter wheels to overcome obstacles



It can be converted in single trolley

SINGLE TROLLEY KIT

Extra-strong
micropallinated stainless steel chassis

Double connection bottle
for easy filling

High pressure hose to connect
the air bottle to the air pressure
regulator.

The air pressure regulator
is protected by a roll-bar

Wheel gun holder

Hose holder

Large diameter wheels
to overcome obstacles

C.01.0010

The kit includes:

- No. 1 single trolley
- No. 1 18 litres bottle with double connection
- No. 1 air bottle trolley kit
- No. 1 F4 air pressure regulator
(DIN air bottle connector included)



AIR JACK TROLLEY KIT

Extra-strong steel chassis

Wheel gun holder

Double connection bottle
for easy filling

A metal bar protects the new position
of the air pressure regulator.

Hose holder

Large diameter wheels
to overcome obstacles



An assembly containing fewer connections between the air bottle and the air pressure regulator, making its final price more competitive while maintaining a high level of safety and quality.

The utilization of the trolley is possible both vertically and horizontally.

C.01.0019

The kit includes:

- No. 1 single trolley
- No. 1 15 litres bottle with double connection
- No. 1 F1 air pressure regulator (DIN air bottle connector included)

TRACK DAYS TROLLEY KIT

Simplified steel chassis

A metal bar protects the new position of the air pressure regulator.

Double connection bottle for easy filling

Hose holder

Large diameter wheels to overcome obstacles

The simplified steel chassis and the fewer connections between the air bottle and the air pressure regulator make the final price more competitive while maintaining a high level of safety and quality.

The utilization of the trolley is possible both vertically and horizontally.



C.01.0021

The kit includes:

- No. 1 single trolley
- No. 1 15 litres bottle with double connection
- No. 1 F1 air pressure regulator (DIN air bottle connector included)

NIPPLE FOR AIR BOTTLE



B.21.0089
Nipples 1/4" bsp female - 7/16" unf male

This is the nipple to adapt the air pressure regulators connectors to be connected to the air bottle through the high pressure hose coming from the high pressure compressor.



AIR BOTTLES VALVES



B.22.04.0001



B.22.04.0000

The air bottle valve is available with single or double connection.
It can be fitted with the connection placed upon the air bottle collar M25x2.

AIR BOTTLE HOSE



B.21.0034

High pressure hose connection (220 bar) between air bottle and air pressure regulator.
Equipped with paintball, connector and valve.
Other dimensions available on demand.



HIGH PRESSURE AIR BOTTLE COMPRESSORS



Automatic pressure regulator



Pressure switch for automatic stop



Compressor hours-counter



Gauge, tap and non-return valve

DPH 220

Standard compressor configuration with:

- automatic condensate drain with timer
- double pressure: 225 and 330 bar
- pressure switch for automatic stop
- non-return valve

Optionals available on request for DPH220 and DPH460 models:

- hours-counter (code B.21.0202)
- trolley (code B.21.0203)
- automatic pressure regulator (code B.21.0204)



Trolley handle



Automatic condensate drain with timer



Trolley wheels

HIGH PRESSURE AIR BOTTLE COMPRESSORS



DPH380



DPH220



DPH460

PRODUCT CODE	PRODUCT NAME	ENGINE	CAPACITY	OPERATING PRESSURE	FILLING TIME	NOISE LEVEL	OVERALL DIMENSIONS	DRY WEIGHT
B.21.0101	DPH380*	Three-phase Electric 5,5kW - 7,5HP	300 l/min - 10,6 CFM - 18 m ³ /h	300 bar 4350 psi	6' 44" (air bottle 101 - 0-200 bar)	78 dB	118x54x69 cm 46 1/2x21 1/4x27 5/32 inch	137 kg 302 lb
B.21.0102	DPH220*	Single-phase Electric 2,2kW - 3,0HP	100 l/min - 3,5 CFM - 6 m ³ /h	300 bar 4350 psi	20' (air bottle 101 - 0-200 bar)	79 dB	58x41x41 cm 22 7/8x16 9/64x16 9/64 inch	42,5 kg 93,7 lb
B.21.0103	DPH460*	Subaru Robin Petrol Engine 4,2kW - 6,0HP	100 l/min - 3,5 CFM - 6 m ³ /h	300 bar 4350 psi	20' (air bottle 101 - 0-200 bar)	84 dB	75,5x39x41 cm 29 3/4x15 3/8x16 9/64 inch	42,0 kg 92,6 lb

* Standard: final pressure switch with automatic stop. The new Paoli Pit Stop Compressors can deliver both 220 bar and 300 bar air pressure thanks to the 2 different high pressure hoses included.



COMPRESSORS SERVICE KITS

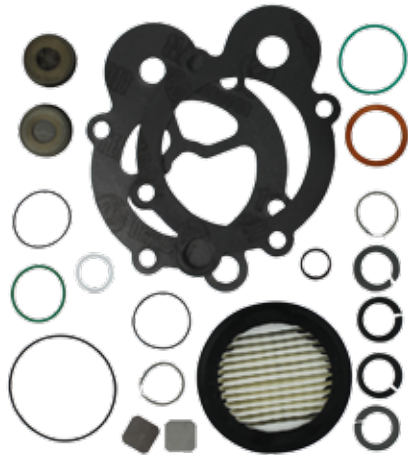

B.21.0163 - SERVICE KIT ATLANTIC

Specifically designed for DPH220 and DPH460
The kit includes: o-rings, piston rings kit, cylinder gasket, top gasket, washer, inlet filter cartridge, outlet valve, aspiration valve, valve spring, valve disc.

B.21.0164 - SERVICE KIT PACIFIC

Specifically designed for DPH380
The kit includes: o-rings, washer, inlet filter cartridge, cylinder o-ring, outlet valve o-ring, valve plate o-ring.

COMPRESSORS FITTINGS



B.21.0065



STANDARD - B.21.0024



B.21.0064



B.21.0028



B.21.0007



B.21.0044

PRODUCT CODE	DESCRIPTION
B.21.0007	DIN 230
B.21.0024	DIN 300
B.21.0044	Italian Connector
B.21.0066	INT Yoke
B.21.0067	DIN/INT Reducer
B.21.0014	BC DIN 230
B.21.0028	BC Italian Connector
B.21.0065	BC INT
B.21.0064	BC DIN 300 USA
B.21.0025	BC DIN 300

COMPRESSORS LUBRICANTS



PRODUCT CODE	QUANTITY	DESCRIPTION
B.27.0001	1 l	Oil for compressor pumping unit DPH6, DPH13
B.27.0003	0,5 l	Oil for compressor pumping unit DPH6, DPH13
B.27.0002	1 l	Oil for compressor engine unit
B.27.0017	1 l	Oil for compressor pumping unit DPH220, DPH460
B.27.0018	1 l	Oil for compressor pumping unit DPH380

Caseliner is a reference point for several racing teams, and it's synonymous with motorsport specialized pit equipment all over the world. The Czech brand produces refuelling equipment, tire transport trolleys and complete pit lane stands systems.

Paoli and Caseliner have been collaborating together for a very long time to offer to their client innovative, reliable and, most of all, winning solutions. In early 2016, the partnership between the two companies has stepped forward, and now Paoli has become an official Caseliner reseller, also preparing the ground for an enhanced collaboration in Italy and more countries.



The background image shows a trade show booth for Caseliner Pitlane Equipment. The booth is constructed from white modular panels and is situated on a checkered floor. Various pieces of equipment, including a metal table, a rolling cart with a silver case, and a large white storage unit, are visible. A sign above the booth reads "CASELINER".

CASELINER®
PIT EQUIPMENT



Caseliner Pitlane Equipment



MAGSEAM SEAMLESS WALLING

MAGSEAM seamless walling is a special seamless surface panels system using unique technology of magnetic attachment. The main advantages of this system are: elegant design which will attract all the attention to your team, variability and time-saving assembly, overall stability of the system due to patented elements which are holding each panel, possibility of full-area printing or colour on demand. Magseam system is supplied on demand with special flight case box for each project.

Complete projects including the custom tv monitors, helmet dryers and other elements are on demand.

GANTRIES

GANTRIES are modular truss structure elements with solid conical connectors. Extremely fast connection for quick, simple and secure assembly. They are used as support for lighting, screens and cables, interior and exterior applications. Caseliner gantries are available in three versions Bi-System (duo), Tri-System (trio) and Quattro-System with certified 50mm tube. Build with us your project.



RACEFLOOR

RACEFLOOR has been developed for all your racing flooring needs. The tiles are easy and quick to install due to an ingenious click lock system, you can combine any colour of tiles with each other. Racefloor is very flexible and strength and it can be used on any flat base, both indoors and outdoors. It is very proof, durable and UV stable flooring with a very good resistance to chemical pollution.

Code B.39.09.0004: Racefloor 1 mq - 1000x1000 mm

Code B.48.0013: Flight Case

POWERHOODS

POWERHOODS are made for lighting in the race boxes, lighting over the race car, motorbike or in the workshops. These light pods are suspended above a vehicle and act as a life support machine supplying the following outputs with zero effect on valuable floor space. POWERHOOD provides high luminosity together with a practical and elegant design. It is possible to be equipped with air distribution and power plugs following customer request and specifications.

Code B.39.11.0001: Powerhood S200-32 (400V/32A)

Code B.39.11.0002: Powerhood S200-16 (230V/16A)



B.39.12.0001

PIT PERCH FORMULA

PIT PERCH FORMULA is stand on the pit lane for the engineers, timekeepers and team managers. Stainless steel construction, textile roof and side walls with zipper system. It is extremely fast to assemble in 10 minutes. One shelf inside provides support for laptops and monitors. The roof and side parts are fully detachable and can be used up to three variants of using of the side parts. Pit perch can be supplied with platform and transport flight case box, which includes required number of rotating chairs with high back. Chairs and monitors are available on demand.

COMING SOON: brand new engineers PC telemetry station. Smart solution of engineer's station for indoor use. New smooth and clean design, all in one solution with opening lid and sliding tv monitors.



B.39.12.0002

PIT PERCH ENDURANCE

PIT PERCH ENDURANCE is designed for 3 engineers. Its design is very elegant, it will attract the attention of your team at the circuit. The basic structure is made of stainless steel tubes with easy connection system. The roof and side parts you can use as the single items, and use it as coming from the climate conditions. Pit perch can be completely closed and protect you from the rain. Very fast installation due to zip-fasteners which are waterproof. Chairs and monitors are available on demand.



LED TIMING BOARD

LED TIMING BOARD is an electronic LED information panel that shows informations to the drivers who are passing through the pit area. High intensity light leds, excellent visibility during high speed drive through, many effects, warning functions, text and image displaying. Simple software with the large number of language versions. Most widely used for endurance racing as 24H Le Mans, WEC, VLN Series, 24H SPA and many other race series.

FOR RACING APPLICATIONS



PIT TROLLEY ENDURANCE

PIT TROLLEY ENDURANCE is all new conception with elegant solution in refuelling area and complete distribution of air and tank hoses at PIT STOP area. Trolley has many of storage areas, including practical entry / rear doors to each sections.

- aluminium construction
- 2080x1080x1100 mm (81,88"x 42,51"x 43,30")
- holder of PAOLI F1, F2, F4 regulators
- standard white color RAL 9010

COMING SOON: Brand new Rotary Boom. Demountable in parts, for easier transport due to very compact size.



PIT TROLLEY FIA

Basic pit trolley for RF200 system, placing of the air pressure bottles and air pressure regulators. We provide various versions of design - positioning of RF200 and rotary boom longitudinal or transverse position toward to passage in the pit lane.

- flight case construction with strengthening floor
- 2250x1050x1190 mm (78,74"x 39,37"x 41,33")
- 4 wheels
- holder for 3 cylinders (av. 233mm type)
- standard black color / colors on demand

FOR TEST APPLICATIONS



REFUELING BOTTLE TROLLEYS

Refueling Bottle Trolley ST: 25 L refueling bottle with valve Staubli.

Refueling Bottle Trolley CL: 25 L refueling bottle with valve Single 2" type PP20M.

Caseliner also offers purposefully designed bottle holders which you can use also as a transport trolley.

DUMP CAN

Draining of vent hose after refueling. Content = 9 L / 2.37 US Gal.



RF200 REFUELING RIG

REFUELING RIG RF200 is designed for a fast refill during endurance races, with a capacity of 200 l / 52,83 gal according to the FIA AP. " J ", 252-7 or ACO 2013.

The closing valves DEADMAN have a return spring and airing system.

- FIA restrictor choice FIA 33mm (1,29") or ACO 28 mm (1,10")
- cover cap for additional electronic fuel gauge condition
- 2x DASH06 fitting for the mechanical measurement fuel system



TYRE HEATER RACK (STANDARD)

Designed for the endurance racing, tyre heater rack can pre-heat up to three sets of tyres. The frame is constructed in two sections from stainless steel. The warm is kept within the rack by a strong PVC silver/thermo AIRTEX awning, which can be unzipped in two individual sections.

Transport flight case is optional.

- full demountable
- 2000 mm width (78,74")
- 2000 mm high (78,74")
- 1000 mm depth (39,37")

Code B.39.05.0002: Diesel heating device



B.39.05.0001



TYRE HEATER RACK ENDU2 / TYRE HEATER RACK ENDU4

Special warm box designed for heating of tyres during the endurance races. Tyre heater rack can pre-heat 2 or 4 sets of tyres. Easy to assemble by aluminium construction with a textile covering AIRTEX and internal thermal material that keeps heat well. Two or four chambers, independently heated with a mechanical controlled temperature level. Two zippered section for access to the tires with a small inspect window control and measure the actual temperature. Transport flight case is optional, for all parts, incl. heater Master.

ENDU 2 (Code B.39.05.0004)

- full demountable
- 1920 mm width (75,59")
- 1900 mm high (75,59")
- 980 mm depth (38,58")

ENDU 4 (Code B.39.05.0006)

- full demountable
- 3800 mm width (149,60")
- 1900 mm high (75,59")
- 980 mm depth (38,58")

TYRE TROLLEY PRO SERIES

High quality trolley made from stainless steel for transport and storage of tyres. Accessories on demand.

- wheels 160 mm (6,29") - 900 kg
- outer high 1500 mm (59,05")
- outer depth 650 mm (25,59")
- horizontal beams 1300 or 1500 mm

Code B.39.05.0013: PRO140

Code B.39.05.0014: PRO160



TYRE BOARD

Special plate TYRES BOARD for stocking and short distance transport of the wheels.

- diam. 620mm / 25,19"
- 4 wheels (2x rotary + 2x with brake)
- black color
- 15 mm plywood
- max. load weight 300 kg



B.39.05.0015

TYRE TROLLEY HEATING

Folding trolley made from stainless steel designed to heat the tyres with warm up quilts.

- 4x wheels 80mm (3,14")
- folding plate with quick release



B.39.05.0012

TYRE TROLLEY FORMULA

High quality trolley made from stainless steel for transport of tyres. Folding plate.

- 2x wheels 200mm / 7,87"
- folding handle
- high 1400mm / 55,11"



B.39.05.0005



BELT BARRIERS

Crowd control belt barriers with internal mechanism equipped with centrifugal belt-breaking system. Belt length is 2,3 m. Available colors: black (B.39.10.0004), grey (B.39.10.0001), blue (B.39.10.0002) and red (B.39.10.0003). Transport flight cases (B.48.0014), bags and printing are optional.

- height 1000 mm / 39,37"
- belt length 2,3 m / 90,55"
- total weight approx. 12 kg / 26,45 lb



MECHANIC CHAIRS

Stainless steel mechanic's chair with 4 wheels and tools area.

Code: B.39.13.0001

- 4x double-wheel
- 30 mm stainless steel
- black plywood upholstered seat
- tools area



WHEELS BATH

It is ideal for easy cleaning tires and wheels. It is fitted with two pairs of bearing rollers for easy rotation of the wheel during cleaning.

Available:

- B.39.07.0001: wheel bath single
- B.39.07.0002: wheel bath double

- material stainless steel
- removable legs, one adjustable leg
- adjustable rotary rollers.



PIT EQUIPMENT

Paoli Pitlane Equipment

MOTORSPORTS WIRING

MOTORSPORTS DATA WIRING

Motorsports Wiring with Race-Spec is very similar to military and aerospace specification.

It evolved from aircraft and military specifications wherein light weight and reliability are paramount. As motorsports evolved into an increasingly more sophisticated and expensive professional endeavor, specific motorsport connectors have evolved which are even lighter and smaller than their aerospace counterparts.

Harnesses are built using Spec55 wires insulated with modified radiation cross-linked ETFE polymer. It has a temperature rating of -65°C to 200°C [-85°F to 392°F] continuous using a silver plated copper conductor, and combines the easy handling of a flexible wire with excellent scrape abrasion and cut-through characteristics.

Harness are protected with System 25 hat shrinking sleeves and boots. DR-25 heat-shrinkable tubing is flexible and abrasion resistant. It is made from a radiation cross-linked elastomeric material specially formulated for optimum high temperature fluid resistance, and long term heat resistance. The operating temperature of DR-25 tubing is from -75°C to +150°C for long periods.

Connectors used, are specifically projected for motorsport application. They offer weight and space saving over standard military designs and is available a wide variety of options, with medium and high density arrangements.

Between connectors and sleeve are applied heat-shrinkable molded specifically formulated and designed to provide optimum high-temperature fluid resistance and longterm heat resistance. They are particularly suitable for sealing and strain relief at connector-cable terminations and cable-to-cable transitions on military vehicle cables and harnesses. Operating temperature are from -75°C to 150°C [-103°F to 302°F] for long periods.

CONTACTS NUMBER	RECEPTACLE TYPE 0 (Male - with flange)	RECEPTACLE TYPE 1 (Male - inline)	PLUG TYPE 6 (Female)
3	ASU003-03PN	ASU103-03PN	ASU603-03SN
6	AS008-35PN	AS108-35PN	AS608-35SN
13	AS010-35PN	AS110-35PN	AS610-35SN

Other connectors, wirings and arrangements are available on request.

GREAVES 3D TYRE SCRAPER



B.39.04.0001

PROFESSIONAL TYRE SCRAPER – TS-03

This professional tyre scraper removes pick and debris with ease leaving a smooth undamaged surface and prolonging the life of the tyres.

The tyre scraper has now been redesigned to make the process more effective and efficient.

- 2000W output – 100 to 600 degree temperature range
- 300-600l/min maximum airflow
- With a moulded handle for user comfort
- Adjustable handle and blade position to suit the user
- Integrated heat gun with variable temperature and fan speed
- Ergonomically design to increase productivity
- Suitable for all forms of racing from karting to F1

AIRJACKS



LL-21 / LL-31
"PROFESSIONAL"

KRONTEC

PRODUCT NAME	PRODUCT CODE	STROKE	Ø	Ø MOUNTING	THREAD MAX	LIFT CAPABILITY
LL-21	B.37.02.0006	230 mm	60 mm	64 mm	M60x1,5	750kg / 40bar
LL-21-PP	B.37.02.0007	230 mm	60 mm	68 mm	M60x1,5	562kg / 30bar
LL-21-150	B.37.02.0008	150 mm	60 mm	64 mm	M60x1,5	375kg / 20bar
LL-21-SP	On request					
LL-31	B.37.02.0009	230 mm	50 mm	53 mm	M50x1,5	488kg / 40bar
LL-31-150	B.37.02.0010	150 mm	50 mm	53 mm	M50x1,5	366kg / 30bar
LL-31-SP	On request					244kg / 20bar

LL-22 / LL-32
"STANDARD"

KRONTEC

PRODUCT NAME	PRODUCT CODE	STROKE	Ø	Ø MOUNTING	THREAD MAX	LIFT CAPABILITY
LL-22	B.37.02.0014	230 mm	60 mm	64 mm	M60x1,5	750kg / 40bar
LL-22-PP	B.37.02.0015	230 mm	60 mm	68 mm	M60x1,5	562kg / 30bar
LL-22-150	B.37.02.0016	150 mm	60 mm	64 mm	M60x1,5	375kg / 20bar
LL-22-SP	On request					
LL-32	B.37.02.0017	230 mm	50 mm	53 mm	M50x1,5	488kg / 40bar
LL-32-150	B.37.02.0018	150 mm	50 mm	53 mm	M50x1,5	366kg / 30bar
LL-32-SP	On request					244kg / 20bar

AIRJACKS

LL-23
"PROFESSIONAL"

PRODUCT NAME	PRODUCT CODE	STROKE	Ø	Ø MOUNTING	THREAD MAX	LIFT CAPABILITY
LL-23	B.37.02.0011	230 mm	60 mm	64 mm	M60x1,5	750kg / 40bar 562kg / 30bar 375kg / 20bar
LL-23-PP	B.37.02.0012	230 mm	60 mm	68 mm	M60x1,5	
LL-23-150	B.37.02.0013	150 mm	60 mm	64 mm	M60x1,5	
LL-23-SP	On request					

LL-24
"STANDARD"

PRODUCT NAME	PRODUCT CODE	STROKE	Ø	Ø MOUNTING	THREAD MAX	LIFT CAPABILITY
LL-24	B.37.02.0019	230 mm	60 mm	64 mm	M60x1,5	750kg / 40bar 562kg / 30bar 375kg / 20bar
LL-24-PP	B.37.02.0020	230 mm	60 mm	68 mm	M60x1,5	
LL-24-150	B.37.02.0021	150 mm	60 mm	64 mm	M60x1,5	
LL-24-SP	On request					



PRODUCT NAME	PRODUCT CODE	STROKE	Ø	Ø MOUNTING	THREAD MAX	LIFT CAPABILITY
JAC 06.9050	B.37.02.0001	236 mm	50 mm	53 mm	M50x1,5	488kg / 40bar 366kg / 30bar 244kg / 20bar
JAC 06.9050/QE	B.37.02.0002	236 mm	50 mm	53 mm	M50x1,5	
JAC 06.9060	B.37.02.0003	230 mm	60 mm	64 mm	M60x1,5	750kg / 40bar 562kg / 30bar 375kg / 20bar
JAC 06.9060/PO	B.37.02.0004	230 mm	60 mm	68 mm	M60x1,5	
JAC 06.9060/QE	B.37.02.0005	230 mm	60 mm	64 mm	M60x1,5	

AIRLANCE



KRONTEC
Fitting & Hose Systems

The KRONTEC "easy-push" system allows a powerless coupling process. The air lance can be used with three connection valves.

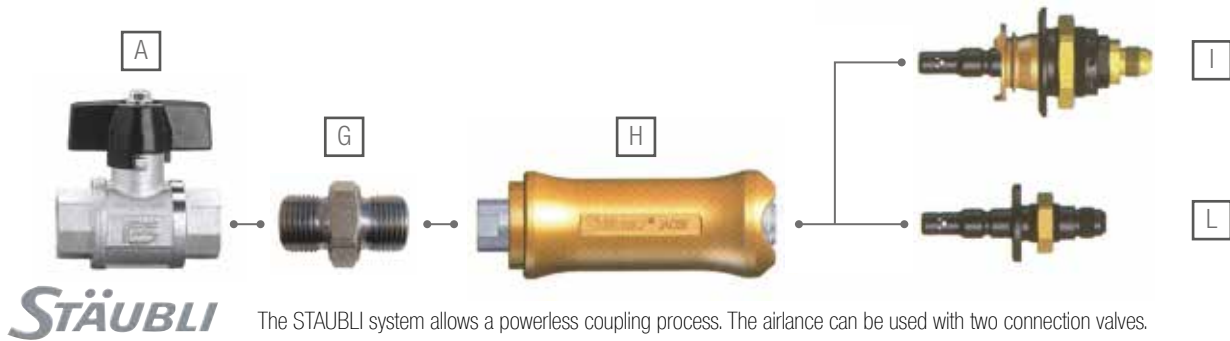

STÄUBLI

The STÄUBLI system allows a powerless coupling process. The air lance can be used with two connection valves.

AIRLANCE

	PRODUCT NAME	PRODUCT CODE	THREAD	OPERATING PRESSURE	SIZE
A		B.37.03.0006	3/8" BSP female	100 bar	
B		B.37.03.0007	M16x1,5 male 3/8" BSP male		
C	LL-03	B.37.01.0001	M16 x 1,5 female	0-40 bar	L 230 x D 37 mm
D	LL-16	B.37.03.0002	D-06 9/16-18 UNF	0-40 bar	L 86 mm
E	LL-13	B.37.03.0001	D-06 9/16-18 UNF	0-40 bar	L 81 mm
F	LL-16 plus	B.37.03.0003	D-06 9/16-18 UNF	0-40 bar	L 86 mm
G		D.04.06.0025	3/8" BSP male		
H	JAC 06.1102	B.37.01.0002	3/8" BSP female	15-40 bar	L 130 x D 48 mm
I	JAC 06.5655	B.37.03.0004	D-06	15-40 bar	L 102 mm
L	JAC 06.4655	B.37.03.0005	D-06	15-40 bar	L 83 mm

HIGH PRESSURE LIFTING BAGS / ROUND SHAPED

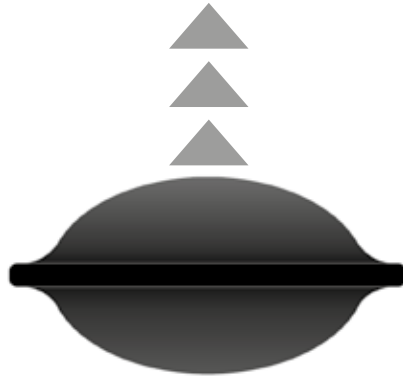

ROUND LIFTING BAGS

High-pressure round lifting bags are used for lifting the heaviest loads. They exert maximum force in a concentrated area, making them ideal when lifting rigid structures in tight places.

- Strong manipulation handles
- Cone-shaped protection edges
- Unique anti-slip surface
- EN 13731 Certified
- Extremely Durable
- Thin Design

PRODUCT NAME	PRODUCT CODE	DIMENSIONS	WEIGHT kg	WORKING PRESSURE		AIR CONSUMPTION l/min	MAX LIFTING CAPACITY		MAX LIFTING HEIGHT	
		cm		bar	psi		t	pounds	cm	inches
M-LB01R	B.37.09.01.0001	15 x 15	0.55	8	116	5	0.8	1763.7	8	3.1
M-LB03R	B.37.09.01.0002	22.5 x 22.5	1.25	8	116	15	2.7	5952.5	13	5.1
M-LB06R	B.37.09.01.0003	30 x 30	2	8	116	42	5.5	12125.4	16	6.3
M-LB10R	B.37.09.01.0004	38 x 38	3.5	8	116	86	10.1	22266.7	21	8.3
M-LB14R	B.37.09.01.0005	45 x 45	5	8	116	152	13.5	29762.4	25	9.8
M-LB21R	B.37.09.01.0006	55 x 55	7	8	116	296	21.1	46517.5	30	11.8
M-LB25R	B.37.09.01.0007	61 x 61	9	8	116	416	25.2	55556.5	34	13.4
M-LB33R	B.37.09.01.0008	69 x 69	11	8	116	621	33	72752.5	38	15
M-LB45R	B.37.09.01.0009	78 x 78	14	8	116	921	44.6	98326.2	42	16.5
M-LB55R	B.37.09.01.0010	87 x 87	18	8	116	1305	55	121254	47	18.5
M-LB70R	B.37.09.01.0011	94.5 x 94.5	22.5	8	116	1505	70.4	155205.4	52	20.5

HIGH PRESSURE LIFTING BAGS / FLAT SHAPED

FLAT LIFTING BAGS

High-pressure flat lifting bags are used for lifting the heaviest loads.

They exert maximum force in a concentrated area, making them ideal when lifting rigid structures in tight places. Flat lifting bags have a flat working surface: they start out flat and remain flat even when fully inflated.

- Flat surface
- Greater contact surface and stability
- High lift and high capacity
- Strong manipulation handles
- Cone-shaped protection edges
- Unique anti-slip surface
- EN 13731 Certified
- Extremely Durable
- Thin Design

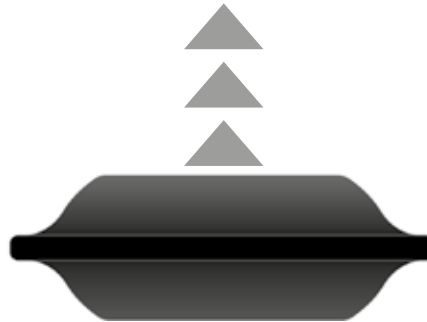

PRODUCT NAME	PRODUCT CODE	DIMENSIONS	WEIGHT	WORKING PRESSURE		AIR CONSUMPTION	MAX LIFTING CAPACITY		MAX LIFTING HEIGHT		MAX LIFTING CAPACITY & MAX LIFTING HEIGHT	
		cm		bar	psi		t	pounds	cm	inches	t	pounds
M-LB07F	B.37.09.02.0001	55 x 55	7	8	116	224	21.1	46517.5	17	6.7	6.7	14771
M-LB10F	B.37.09.02.0002	61 x 61	9	8	116	350	25.2	55556.5	17	6.7	9.5	20943.9
M-LB20F	B.37.09.02.0003	78 x 78	14	8	116	520	44.6	98326.2	17	6.7	20.2	44533.4
M-LB33F	B.37.09.02.0004	91.5 x 91.5	20	8	116	810	64	141096	17	6.7	33.3	80689.2

ELEPHANT LEG



LL-20 CL

	PRODUCT NAME	PRODUCT CODE	HEIGHT	FOR CYLINDER SIZE	FOR AIRJACK SIZE
TWO-STAGE ELEPHANT LEG <i>KRONTEC</i>	LL-20 CL	B.37.04.0007	60 mm	60 mm	LL-21, LL-22, LL-23, LL-24
	LL-20 CL-PP	B.37.04.0008	60 mm	60 mm	LL-21-150, LL-22-150, LL-23-150, LL-24-150
	LL-30 CL	B.37.04.0009	50 mm	50 mm	LL-31, LL-32
	LL-30 CL-PP	B.37.04.0010	50 mm	50 mm	LL-31-150, LL-32-150
TWO-STAGE ELEPHANT LEG <i>STÄUBLI</i>	JAC 06.9056	B.37.04.0011	434 mm	50 mm	JAC 06.9050, JAC 06.9050/QE
	JAC 06.9065	B.37.04.0012	434 mm	60 mm	JAC 06.9060, JAC 06.9060/QE
	JAC 06.9067	B.37.04.0013	409 mm	60 mm	JAC 06.9060/PO

AIRJACK SAFETY PROP



LL-90 - LL-91

	PRODUCT NAME	PRODUCT CODE	HEIGHT	FOR CYLINDER SIZE	FOR AIRJACK SIZE
ONE STAGE <i>KRONTEC</i>	LL-90	B.37.04.0001	230 mm	60 mm	LL-21, LL-22, LL-23, LL-24
	LL-90-150	B.37.04.0002	150 mm	60 mm	LL-21-150, LL-22-150, LL-23-150, LL-24-150
	LL-91	B.37.04.0003	230 mm	50 mm	LL-31, LL-32
	LL-91-150	B.37.04.0004	150 mm	50 mm	LL-31-150, LL-32-150
ONE STAGE <i>STÄUBLI</i>	JAC 06.9055	B.37.04.0005	228,5 mm	50 mm	JAC 06.9050, JAC 06.9050/QE
	JAC 06.9066	B.37.04.0006	228,5 mm	60 mm	JAC 06.9060, JAC 06.9060/QE, JAC 06.9060/PO

FLIGHT CASES



B.48.0001



B.48.0003



B.48.0002

PRODUCT CODE	DIMENSION	WEIGHT	DESCRIPTION
B.48.0001	99 X 76 X 89 H cm	98,50 kg	for tools, accessories and pit equipment
B.48.0002	73 x 44 x 56 H cm	13,80 kg	for Paoli compressors DPH220
B.48.0003	88 X 54 X 70 H cm	32,50 kg	for Paoli compressors DPH460

Customizations available:

- Overall dimensions
- Drawers configuration
- Logo engraving
- Many finishes of color available (embossed, quartz and smooth)
- Many colors available

FRONT & REAR AIR JACK TROLLEYS



B.37.05.02.0001



B.37.05.02.0002



B.37.05.02.0003
B.37.05.02.0004



B.37.05.02.0005
B.37.05.02.0006

Pneumatic air jacks to lift racing cars of all types of formula and gt cars / The attachments can be adapted to your model car and championship / Special attachments are available on request if car drawings and pictures are supplied / 4 Light version available

PRODUCT CODE	DESCRIPTION	NOTE
B.37.05.02.0001	Front Air Jack	Usable in most championships except for FORMULA 2, GP3, WSR 3.5, Superleague. In any case the championship and/or the car must be known.
B.37.05.02.0002	Rear Air Jack	
B.37.05.02.0003	Front Air Jack	Usable in FORMULA 2, GP3, WSR 3.5, Superleague. In any case the championship and/or the car must be known.
B.37.05.02.0004	Rear Air Jack	
B.37.05.02.0005	Front Air Jack	Without shovels. If the customer fabricates special shovels for their car.
B.37.05.02.0006	Rear Air Jack	

GLOVES

PRODUCT NAME	PRODUCT CODE	SIZE	COLOURS	NOTE
FAST FIT®	B.38.01.01.0002	M	black	Easy On/Off Fit Glove - With improved contours for a better fit, the Fast Fit® Glove is the tool to use for everyday jobs. The glove incorporates a Clarino Synthetic Leather palm, stretch panels between the fingers, two-way stretch Spandex padded back increases protection. A new taller cuff has been added to provide for additional protection and a more secure fit. Performance plus economy. Machine washable.
	B.38.01.01.0003	L		
	B.38.01.01.0004	XL		
M-PACT® 2	B.38.01.01.0026	M	black	Heavy Duty Glove - For super protection and an unbelievable fit, try the M-Pact® 2 Glove. Anatomically designed with advanced features that include tapered stretch side panels that form comfortably between fingers and a molded Neoprene cuff for a seamless fit to your wrist. It also has an integrating impact absorbing molded rubber finger protection and EVA deep ribbed accordion knuckle protection. This glove has it all. Machine washable.
	B.38.01.01.0027	L		
	B.38.01.01.0028	XL		
ORIGINAL® GLOVE	B.38.01.01.0006	M	black	All-Purpose Glove - Designed and manufactured to take on the toughest tasks you can throw at it, the Original® Glove provides a winning combination of versatility and performance. The Clarino Synthetic Leather palm and fingertips extends the life of the glove while the Thermal Plastic Rubber hook and loop cuff closure and two-way stretch Spandex top provides a perfect fit. Machine washable.
	B.38.01.01.0007	L		
	B.38.01.01.0008	XL		
	B.38.01.01.0011	L	red	
	B.38.01.01.0012	XL		
B.38.01.01.0014	M	blue		
B.38.01.01.0015	L			
ORIGINAL® VENT	B.38.01.01.0023	L	black	Fully Ventilated Glove - Improved design. Designed for hot or humid conditions, the Original® Vent Glove gives you a single-layer of lightweight air mesh on the top to minimize heat build-up while it's perforated Clarino Synthetic Leather palm and fully ventilated construction keeps the entire hand comfortable and cool. A new taller cuff with an improved rubber closure system gives you the confidence you need when the heat is on. Machine washable.
	B.38.01.01.0024	XL		



FAST FIT®



M-PACT® 2



ORIGINAL® GLOVE



ORIGINAL® VENT

PAOLI PIT STOP HELMETS



VERSION WITH SHELL IN CCF
(CARBON COMPOSITE FIBER)

- Shell in CCF (Carbon Composite Fiber)
- Fireproof painting
- Retractable visor with an anti-scratch coating
- Removable and washable inner lining. With fireproof materials (NOMEX)
- Magnetic buckle
- Fireproof kevlar chinstrap
- Helmet bag included

Certification: EN 1077 Class A

PRODUCT CODE	SIZE
B.38.04.01.0009	M (58)
B.38.04.01.0010	L (60)
B.38.04.01.0011	XL (61)
B.38.04.01.0012	XXL (63)



VERSION WITH SHELL IN HTR
(HIGH THERMOPLASTIC RESIN)

- Shell in HTR (High Thermoplastic Resin)
- Ultra-resistant painting
- New anti-fog and anti-scratch mirror visor equipped with a rubber trim
- Removable and washable inner lining.
- Micrometric buckle
- Goggle strap holder on the back, to keep the strap of the goggle in place
- DAF ventilation system (Direct Air Flux)

PRODUCT CODE	SIZE
B.38.04.01.0001	M (58)
B.38.04.01.0002	L (60)
B.38.04.01.0003	XL (61)



PRODUCT CARE

Service and overhaul



SERVICE

PAOLI SERVICE

To ensure the reliability, accuracy, power and speed of our product, we recommend a complete overhaul. Our After Sale Service can provide information about after how many cycles (No. 1 cycle = No. 1 LOOSENING + No. 1 TIGHTENING) the service is required.

You can also require the repainting of the tool to get it back to the aesthetic (and functional) conditions similar to a new wheel gun. The service Test carries out laboratory testing on individual components subject to greater effort. It is possible also to convert the directionality (for each wheel gun model), transforming it to its different versions (UH, RH, LH).





- **S - SERVICE AND REPAIR:**
the wheel gun is fully overhauled, cleaned, all consumable components replaced and finally tested
- **R - SERVICE, REPAIR AND REPAINT:**
in addition to the service S, the wheel gun is repainted
- **T - SERVICE, REPAIR, AND TEST REPAINT:**
in addition to service R, the wheel gun is subjected to various tests that certify the conformity of the components
- **C - SERVICE, REPAIR, REPAINT AND CONVERSION:**
in addition to service R, the wheel gun is transformed to its different versions (UH, RH, LH).

The table on the following page details all transactions carried out for each type of service.

WHEEL GUNS SERVICE PROCEDURE

	S SERVICE REPAIR	R SERVICE REPAIR REPAINT	T TEST	C SERVICE REPAIR REPAINT CONVERSION
CHECK Check of the table "Request for Service & Maintenance" that is filled in to the customer.	✓	✓		✓
DISASSEMBLING The wheel gun is completely disassembled.	✓	✓		✓
EXAMINE Check of each part for conformity.	✓	✓		✓
CLEANING Each part is cleaned and the grease is taken off.	✓	✓		✓
REPLACEMENT Replacement consumables parts (service kit: vanes, screws, washers, valve seat).	✓	✓		✓
DE-PAINTING The alloy parts are de-painted. The clutch cover is re-coated.		✓		✓
RE-ASSEMBLING The wheel gun is re-assembled.	✓	✓		✓
TEST The wheel gun is tested.	✓	✓		✓
RE-PAINTING The wheel gun is prepared for the re-painting and then properly re-painted.		✓		✓
CONVERSION Some parts are replaced to convert the wheel guns into UH, RH, LH versions.				✓
CERTIFICATE This document certifies the parts that have been replaced and the tightening torque the gun reaches after the service.			✓	
MAGNETOSCOPIC INSPECTION The method is designed for the inspection of small parts through fluorescent magnetoscopic inspection.			✓	

WHEEL GUNS SERVICE CODES







	S	R	T	C
HURRICANE	R.01.01.01.0055	R.01.01.01.0056	R.05.01.01.0001	
DP 6000	R.01.01.01.0049	R.01.01.01.0050	R.05.01.01.0001	
DP 6000 BIAS	R.01.01.01.0059	R.01.01.01.0060	R.05.01.01.0001	
DP 5000 TI MARK II	R.01.01.01.0040	R.01.01.01.0041	R.05.01.01.0001	
DP 5000 BIAS	R.01.01.01.0053	R.01.01.01.0054	R.05.01.01.0001	
DP 4000 30BAR	R.01.01.01.0044	R.01.01.01.0045	R.05.01.01.0001	
DP 4000 MG	R.01.01.01.0032	R.01.01.01.0033	R.05.01.01.0001	
SUPERSPORT	R.01.01.01.0030	R.01.01.01.0031	R.05.01.01.0001	
DP 4000 BIAS	R.01.01.01.0042	R.01.01.01.0043	R.05.01.01.0001	
DP 4000	R.01.01.01.0023	R.01.01.01.0024	R.05.01.01.0001	LH  RH R.02.01.01.0038 RH  LH R.02.01.01.0039 UH  RH R.02.01.01.0040 UH  LH R.02.01.01.0041 LH / RH  UH R.02.01.01.0042
DP 3000	R.01.01.01.0019	R.01.01.01.0020	R.05.01.01.0001	

WHEEL GUNS SERVICE CODES



	S	R	T	C
DP 2000 SE	R.01.01.01.0001	R.01.01.01.0002	R.05.01.01.0001	LH RH R.02.01.01.0009
DP 2000 S				RH LH R.02.01.01.0010
DP 2000				UH RH R.02.01.01.0012
				UH LH R.02.01.01.0011
DP 197 SFE	R.01.01.01.0009	R.01.01.01.0010	R.05.01.01.0001	LH RH R.02.01.01.0016
DP 197 SF				RH LH R.02.01.01.0017
DP 197 S				LH / RH UH R.02.01.01.0033
DP 196 S				
DP 176 SFE	R.01.01.01.0046	R.01.01.01.0047	R.05.01.01.0001	
DP 177 SF				
DP 176 SF	R.01.01.01.0007	R.01.01.01.0008	R.05.01.01.0001	LH RH R.02.01.01.0025
				RH LH R.02.01.01.0026
BLUEDEVIL	R.01.01.01.0026	R.01.01.01.0027	R.05.01.01.0001	
DP 36 SF	R.01.01.01.0021	R.01.01.01.0022	R.05.01.01.0001	
DP 36 SF EVO	R.01.01.01.0034	R.01.01.01.0035	R.05.01.01.0001	
4 BIKE	R.01.01.01.0057	R.01.01.01.0058	R.05.01.01.0001	
MAGNETOSCOPIC INSPECTION			R.05.01.01.0002	



NOTE: just if no major parts need to be replaced, otherwise a new estimate of cost will be sent

AIR PRESSURE REGULATORS SERVICE & REPAIR

PRODUCT NAME	GAUGES	CODE	PRODUCT NAME	GAUGES	CODE		
F1		STANDARD	R.01.03.0001	F15		STANDARD	R.01.03.0021
	GLYCERIN	R.01.03.0008					
F2		STANDARD	R.01.03.0002	F4		STANDARD (gold version)	R.01.03.0003
	GLYCERIN	R.01.03.0010			STANDARD (silver version)	R.01.03.0027	
F9		STANDARD	R.01.03.0014	F40		GLYCERIN (gold version)	R.01.03.0009
					GLYCERIN (silver version)	R.01.03.0028	
				F50		STANDARD	R.01.03.0022
					GLYCERIN	R.01.03.0029	

ACCESSORIES SERVICE & REPAIR

PRODUCT NAME	GAUGES	CODE
AIR BOTTLES		
	SERVICE	R.01.03.0011
PETROL ENGINE COMPRESSOR		
	SERVICE	R.01.03.0005
ELECTRIC COMPRESSOR		
	SERVICE	R.01.03.0004

PRODUCT NAME	GAUGES	CODE
HOSES		
	SERVICE	R.01.03.0006
COUPLINGS		
 TST EUROPE DN11	SERVICE	R.01.03.0017
COUPLINGS		
 TST EUROPE DN8	SERVICE	R.01.03.0016

SERVICE KIT



CODE	PRODUCT NAME	AVAILABLE FOR
B.23.0170	KITHURRICANE	HURRICANE
B.23.0138	KIT6000	DP 6000 90° ANGLED HANDLE
B.23.0163	KIT6000	DP 6000 CLASSIC HANDLE
B.23.0208	KIT6000BIAS	DP 6000 BIAS
B.23.0164	KIT5000BIAS	DP 5000 BIAS
B.23.0108	KIT5000TI	DP 5000 TI
B.23.0123	KIT400030BAR	DP 4000 30BAR
B.23.0079	KIT4000MG	DP 4000 MG
B.23.0048	KIT4000	DP 4000
B.23.0107	KIT4000BIAS	DP 4000 BIAS
B.23.0001	KIT2000S	DP 2000 S, SE
B.23.0089	KITSUPERSPORT	SUPERSPORT
B.23.0002	KIT197SF	DP 197 SF, SFE
B.23.0119	KIT176SFE	DP 176 SFE, DP 177 SFE
B.23.0054	KITBLUEDEVIL	BLUE DEVIL
B.23.0080	KIT36SFEVO	DP 36 SF EVO, 4 BIKE
B.23.0104	KIT36SFEVOUS	DP 36 SF EVO US
B.40.0052	KITF4	F4 (gold version)
B.40.0065	KITF4	F4 (silver version)
B.40.0053	KITF9	F9
B.40.0054	KITF1F2	F1, F2
B.40.0055	KITF1F2B	F1, F2 (yellow brass version)
B.40.0050	KITF15	F15
B.40.0051	KITF40	F40

Dino Paoli S.r.l. does not assume responsibility for the use of the kits by unauthorized or not properly trained workers.

SERVICE TOOLS



CODE	AVAILABLE FOR
B.23.0159	DP 6000, DP 5000 TI MARK II, DP 4000 MG, DP 2000 SE

For the single codes of the tools please refer to the repair manual of the specific model.

WHEEL GUN LUBRICANTS



B.27.0007



B.27.0004



B.27.0005



B.27.0016

PRODUCT CODE

QUANTITY DESCRIPTION

B.27.0007	1 kg	Special Grease for PAOLI wheel gun hammer mechanism.
B.27.0004	1 l	Special Oil for PAOLI wheel gun motors.
B.27.0005	5 l	Special Oil for PAOLI wheel gun motors.
B.27.0016	500 ml	Special <i>fin Lube</i> spray Lubricant for PAOLI wheel gun motors (it contains microspheres of teflon which enhance the inner surface protection and lubrication).

WHEEL GUNS SPARE PARTS

DP 6000

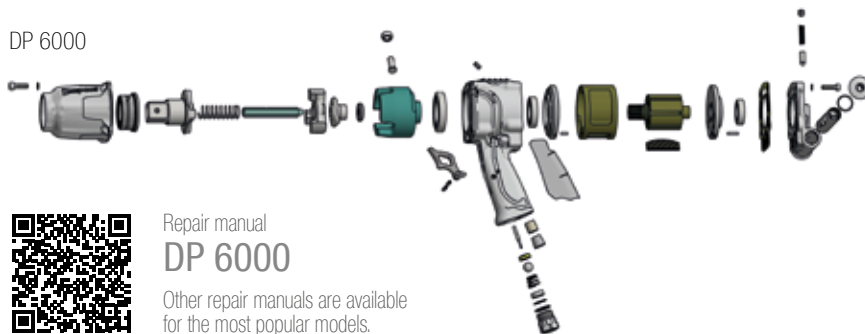

Repair manual
DP 6000

Other repair manuals are available for the most popular models.

SPARE PARTS

As manufactures of our wheel guns we get available to our customers all the spare parts for maintenance and repair. Contact us for inquiries and quotes.

ACCESSORIES SERVICE & REPAIR

Across the range of accessories that we sell we provide sales of spare parts. Please contact us for all your needs.

We repair and overhaul all our products. Please contact our After Sales Service for information.



































www.paoli.net





































WHEEL GUN CONFIGURATION

CONFIGURE YOUR
PAOLI WHEEL GUN

WHEEL GUN		HANDING			SHUTTLE MOTION		COVER MATERIAL	
		LH	RH	UH	3PORT	2PORT	CARBON	ALUMINIUM
HURRICANE CLASSIC HANDLE								
		<input type="checkbox"/>	<input type="checkbox"/>	<input type="checkbox"/>	<input type="checkbox"/>	<input type="checkbox"/>	<input type="checkbox"/>	<input type="checkbox"/>
HURRICANE 90° ANGLED HANDLE								
		<input type="checkbox"/>	<input type="checkbox"/>	<input type="checkbox"/>	<input type="checkbox"/>	<input type="checkbox"/>	<input type="checkbox"/>	<input type="checkbox"/>
DP 6000 CLASSIC HANDLE								
		<input type="checkbox"/>	<input type="checkbox"/>	<input type="checkbox"/>	<input type="checkbox"/>	<input type="checkbox"/>	<input type="checkbox"/>	<input type="checkbox"/>
DP 6000 90° ANGLED HANDLE								
		<input type="checkbox"/>	<input type="checkbox"/>	<input type="checkbox"/>	<input type="checkbox"/>	<input type="checkbox"/>	<input type="checkbox"/>	<input type="checkbox"/>

PLEASE, PUT A TICK IN THE REQUIRED BOXES AND SEND THE DOCUMENT AT SALES@PAOLI.NET.

WHEEL GUN		HANDING			SHUTTLE MOTION		COVER MATERIAL	
		LH	RH	UH	3PORT	2PORT	CARBON	ALUMINIUM
DP 6000 BIAS		RH & LH VERSIONS IN A SINGLE GUN			 <input type="checkbox"/>	 <input type="checkbox"/>	 <input type="checkbox"/>	 <input type="checkbox"/>
DP 4000 MG		 <input type="checkbox"/>	 <input type="checkbox"/>	 <input type="checkbox"/>	 <input type="checkbox"/>	 <input type="checkbox"/>	 <input type="checkbox"/>	 <input type="checkbox"/>
DP 4000 30BAR		 <input type="checkbox"/>	 <input type="checkbox"/>	 <input type="checkbox"/>	 <input type="checkbox"/>	 <input type="checkbox"/>	 <input type="checkbox"/>	 <input type="checkbox"/>
DP 3000 SUPERSPORT		 <input type="checkbox"/>	 <input type="checkbox"/>	 <input type="checkbox"/>	 <input type="checkbox"/>	NOT AVAILABLE	 <input type="checkbox"/>	 <input type="checkbox"/>
DP 2000 SE		 <input type="checkbox"/>	 <input type="checkbox"/>	 <input type="checkbox"/>	NOT AVAILABLE	 <input type="checkbox"/>	 <input type="checkbox"/>	 <input type="checkbox"/>

PLEASE, PUT A TICK IN THE REQUIRED BOXES AND SEND THE DOCUMENT AT SALES@PAOLI.NET.



ENGINEERING

ENGINEERING SERVICE

Since 1968 we have been manufacturing wheel guns, and we would now like to get our professionalism and experience available to our customers to an even greater extent.

We have heavily invested in research and development in order to get procedures and instruments suitable for the study and creation of products most suited to the growing needs of the automotive industry.

Dino Paoli is in fact now able to offer to customers an Engineering service which consists in the development of variations of wheel guns components customized according to different needs.

The engineering offer covers several areas: performances, durability, ergonomics, lightness.

To obtain these results we use and work on materials from the aviation and military industry, such as special steels, carbon fibre, aluminium and magnesium alloy, titanium.

The design of the new components is tested using finite element analysis (FEM) and once designed (CAD) these are produced using CAM, which allows us to easily obtain even geometrically complex parts.

Lately we have introduced the CFD air flow analysis to further optimize our wheel guns performances.

We also have a range of suppliers very skilled in heat treatments, who are capable to accurately identify the expected mechanical features.



FAQ

Your questions. Our answers



FAQ FREQUENTLY ASKED QUESTIONS

Why do we have LH, RH, UH wheel guns?

RH and LH give more power on the loosening mode (where it is mostly required), UH delivers the same power on both directions.

What is the difference between a 70/30 wheel gun and a 60/40 wheel gun?

70/30 means that 70% of the power is on the loosening mode; 60/40 means that 60% of the power is on loosening mode.

Which feature have I to keep in mind to chose a hose in order to get the best performance?

The most important feature is the inner diameter of the hose in order to guarantee the correct air flow to the gun.

What is the difference between a 2-port and a 3-port back cover?

The ports are the holes in the shuttle (they can be 2 or 3).

This definition refers to the shuttle motion. The 2-port is normally for right handed operators, the 3-port is normally for the left-handed operators.

What BIAS means and what is its purpose?

BIAS means that the gun is both RH and LH and you can convert it from one version to the other just moving a lever on top of the gun.

What is the difference between static and dynamic pressure?

The static pressure is the pressure you read on the OUT gauge of the regulator when the gun is not working; on the other hand, the dynamic pressure is the pressure you read on the OUT gauge of the regulator when the gun is working (the dynamic pressure is always lower than the static pressure).

Why would I need a Fast Shuttle on my wheel gun?

To be faster at changing the gun direction (from loosening mode to tightening mode just pushing a lever with the thumb or just slightly moving the wrist on the Fast Shuttle 2.0 release).

What is the fluorescent magnetoscopic inspection?

The method, designed for the inspection of small parts, consists of a component immersion in a detecting fluid. Through the magnetization the fluorescent particles are attracted and finally a UV lamp reveals defects and non-compliances.



paoli

17mm



AUTOMOTIVE PRODUCTS

Not for racing applications (lower pressure - 6,3 bar)

AUTOMOTIVE IMPACT WRENCHES

(LOWER PRESSURE - 6,3 BAR)

AUTOMOTIVE IMPACT WRENCHES

Discover a small selection of our automotive impact wrenches for garage applications

Paoli automotive products are designed for optimal garage use.

Our automotive impact wrenches are designed to be lightweight and easy to handle with an optimum weight/power ratio.

Technical features, working pressure and constructive materials are not suitable for racing applications.

You can find all the Paoli automotive products on our website www.paoli.net.

ATTENTION: NOT FOR RACING APPLICATIONS

The company does not suggest the use of these products at a working pressure of over 6.3 bar.

BUTTERFLY



Also available:
BUTTERFLY XC
WITH SCREWDRIVER CONNECTION
Square drive: 1/4" FEM. HEX.

PRODUCT NAME	BUTTERFLY
PRODUCT CODE	BUTTERFLY.001
SQUARE DRIVE	3/8"
BOLT RANGE	M10
ULTIMATE TORQUE	110 Nm (80 ft-lb)
WORKING TORQUE	10-100 Nm 10-75 ft-lb
WEIGHT	0,53 kg - 1.17 lbs
FREE SPEED	12000 rpm
IMPACTS NUMBER	1000/min
MAX WORKING PRESSURE	6,3 bar (91 psi)
AIR INLET	1/4" NPT
INNER HOSE DIAMETER	9,5 mm (0.374")
LENGTH (WITHOUT ANVIL)	130 mm (5.11")
SIDE TO CENTER	20 mm (0,78")

DP 1050



PRODUCT NAME	DP 1050
PRODUCT CODE	001050.00001
SQUARE DRIVE	1/2"
BOLT RANGE	M10-M16
ULTIMATE TORQUE	700 Nm (518 ft-lb)
WORKING TORQUE	100-600 Nm (74-444 ft-lb)
WEIGHT	1,3 kg (2.87 lbs)
FREE SPEED	9000 rpm
IMPACTS NUMBER	1150/min
MAX WORKING PRESSURE	6,3 bar (91 psi)
AIR INLET	1/4" NPT
INNER HOSE DIAMETER	9,5 mm (0.374")
LENGTH (WITHOUT ANVIL)	92 mm (3.62")
SIDE TO CENTER	29 mm (1.14")

DP 1800 PLUS



PRODUCT NAME	DP 1800 PLUS
PRODUCT CODE	1800PL.00001
SQUARE DRIVE	1/2"
BOLT RANGE	M24
ULTIMATE TORQUE	1650 Nm (1200 ft-lb)
WORKING TORQUE	150-900 Nm (110-670 ft-lb)
WEIGHT	1,65 kg (14.33 lbs)
FREE SPEED	9000 rpm
IMPACTS NUMBER	1850/min
MAX WORKING PRESSURE	6,3 bar (91 psi)
AIR INLET	1/4" NPT
INNER HOSE DIAMETER	8 mm (0.315")
LENGTH (WITHOUT ANVIL)	160 mm (6.3")
SIDE TO CENTER	35 mm (1.38")

DP 217 (LONG ANVIL)



ANVIL LENGTH
156,5 mm (6.16")

PRODUCT NAME	DP 217 AL
PRODUCT CODE	000217.00002
SQUARE DRIVE	3/4"
BOLT RANGE	M14-M24
ULTIMATE TORQUE	1700 Nm (1260 ft-lb)
WORKING TORQUE	350-1100 Nm (240-820 ft-lb)
WEIGHT	6,6 kg (14.7 lbs)
FREE SPEED	5400 rpm
IMPACTS NUMBER	1000/min
MAX WORKING PRESSURE	6,3 bar (91 psi)
AIR INLET	1/2" BSP
INNER HOSE DIAMETER	47,5 mm (1.87")
LENGTH (WITHOUT ANVIL)	182 mm (7.17")
SIDE TO CENTER	48 mm (1.89")

DP 246 (LONG ANVIL)

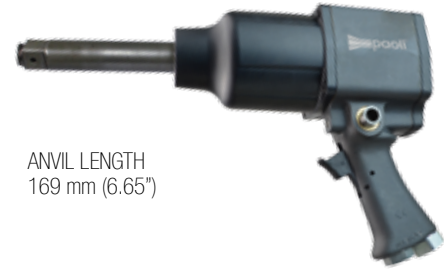

ANVIL LENGTH
169 mm (6.65")

PRODUCT NAME	DP 246 AL
PRODUCT CODE	000246.00003
SQUARE DRIVE	1"
BOLT RANGE	M18-M39
ULTIMATE TORQUE	2796 Nm (2069 ft-lb)
WORKING TORQUE	589-1.373 Nm (436-1016 ft-lb)
WEIGHT	9,17 kg (20.2 lbs)
FREE SPEED	4200 rpm
IMPACTS NUMBER	750/min
MAX WORKING PRESSURE	6,3 bar (91 psi)
AIR INLET	1/2" BSP
INNER HOSE DIAMETER	13 mm (0.512")
LENGTH (WITHOUT ANVIL)	249 mm (9.8")
SIDE TO CENTER	50 mm (1.97")



PAOLI CHAMPIONSHIPS

Asian Formula Renault	Formula Masters China Series	PCCA
Asian Le Mans Series	GP2	Porsche Cup
Audi Sport R8 LMS Cup	GP3	Porsche GT 3 Cup Brasil
Blancpain	GT	Radical Cup China
Cape Town Power Series	IMSA	Scirocco R-Cup
China GT Championship	IndyCar	Stock Car
China Touring Cup	Lamborghini Super Trofeo	Stock Car Light
Copa Petrobras de Marcas	Las 6 horas Peruanas	Super Formula
DTM	Le Mans Cup	Super GT
ELMS	Malaysia Championship	Super TC2000
Endurance	Series	TC2000
Ferrari Challenge	Mercedes Benz Challenge	TCR China
F Nippon	Brasil	TCR International Series
F3 Asian Championship	N1 SuperTaikyu	Thailand Super Series
Formula 1	Nascar	V8 SUPERCAR
Formula 2		



www.paoli.net - sales@paoli.net



 [/company/dino-paoli](https://www.linkedin.com/company/dino-paoli)

 [/dinopaoli](https://www.facebook.com/dinopaoli)

 [/dinopaoli](https://www.instagram.com/dinopaoli)

 [/dinopaoli](https://twitter.com/dinopaoli)

 [/paolipitstop](https://www.youtube.com/paolipitstop)

The information, images and/or data contained in this catalogue are copyrighted by Dino Paoli S.r.l.

All other logos, products and company names mentioned in the Paoli Pit Stop Series Catalogue are trademarks of their respective owners.

Models, specifications, colors and codes are subject to change without prior notice due to continuous improvements.

Thank you for your interest in our products.





Dino Paoli S.r.l.

Via G. Dorso, 5 - 42124 Reggio Emilia - Italy

Tel. +39 0522 364511 - Fax + 39 0522 304864

www.paoli.net

sales@paoli.net

