



**COMETIC**  
GASKET

AND  
**POWERSPORT  
V-TWIN  
PERFORMANCE  
GASKETS**



**NASCAR**  
PERFORMANCE



Cometic Gasket, Inc. An Exclusive NASCAR® Performance Product





# CUSTOM GASKETS



Cometic's custom gaskets can accommodate virtually any engine configuration from naturally aspirated, to the most exotic turbo and nitrous injected engines. Our commitment is to provide innovative, quality gaskets while maximizing your engine's power and performance. When customization is key, Cometic delivers!

Cometic has the ability to customize any gasket to meet your specific application. Need to change the bore size and/or thickness of a gasket? Or do you need a complete gasket design and execution? The process starts with a simple phone call. After Cometic's in-house Technical Sales Team understands your needs, they work directly with our design engineers to insure the gasket is drawn with state-of-the-art software and manufactured with the best materials possible with the most current and efficient manufacturing processes. If special tooling is required, we'll provide a pre-production estimate for approval. Your gasket is then made and shipped. The lead-time on bore and thickness changes is just three days. A complete gasket design takes just two weeks.



The passion for racing runs deep in our Technical Sales and Engineering Teams. We understand the importance of perfection in your next engine build because we are right there with you racing on weekends.

**Call our Technical Sales Team (440) 354-0777**

**visit [www.cometic.com](http://www.cometic.com) for listing of gasket materials and available thicknesses**





Cometic Gasket - An Exclusive NASCAR Performance Product

## GASKET MATERIALS

# MLS Multi Layer Steel Gaskets

Cometic MLS gaskets are comprised of three to five layers of Stainless Steel. Cometic uses Stainless Steel for increased strength, its ability to rebound and corrosion resistance. The outer layers of the gasket are embossed and coated on both sides with a High Performance Polymer coating designed to meet the demands of a variety of harsh sealing environments, load conditions and surface finishes. The coating is heat resistant to 250C or 482F.

The center or shim layer of the gasket is comprised of an uncoated Stainless Steel layer, which can be varied to accommodate multiple thickness requirements. MLS gaskets are ideal for any kind of head and block combination. By design the MLS gasket promotes an even torque load across the sealing surface allowing for measurable reduced bore distortion.

**Available thickness:** .027", .030", .036", .040", .045", .051", .060", .066", .070", .075", .080", .086", .092", .098", 120"

### AFM (Aluminum Foam Material)



A chemically blown, compounded nitrile synthetic rubber bonded to an aluminum core with temperature resistance of over 250F. AFM material has an 85% recovery while maintaining strong torque retention. AFM does not require gasket sealers or re-tightening. **Available thickness:** .018", .032", .060"

### Aramid Fiber



A premium hi-temperature, hi-density creep resistant material that requires no re-torquing and is fuel resistant. All Cometic fiber materials are asbestos free and require no additional sealants. **Available thickness:** .012", .015", .020", .031", .039", .047", .060", .094", .125", .188

### Aluminum



Solid material ideal for spacers and shims.

**Available thickness:** .010", .016", .020", .025", .032", .040", .050"

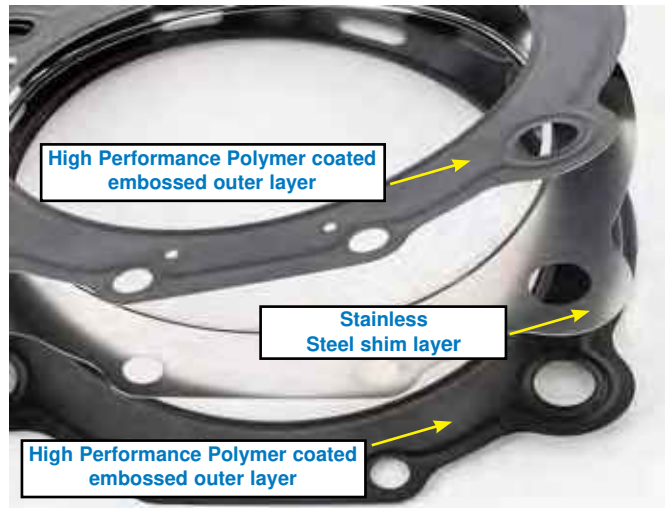

### Nitrile Rubber Coated Steel



A steel core with a .001" thick coating of nitrile rubber on both sides. **Available thickness:** .010", .014", .020"

### Copper (Dead Soft)



**Available thickness:** .005", .010", .016", .020", .027", .032", .043", .050", .063", .080", .094"

### Valve Guide Seals



Cometic viton steel body (VSB) seals are available for most applications ranging from automotive to motorcycles. Valve stem seals are defined first by the actual measurement of the valve stem OD itself then by the guide OD. Proper seal height and width will be determined by valve spring clearance.

## TABLE OF CONTENTS

	Pg.		Pg.		Pg.		Pg.
Arctic Cat UTV .....	6	Cobra .....	34	Husqvarna .....	142	EST Big Twin EVO .....	190
Can-Am Bombardier UTV .....	7	Gas Gas .....	37	Kawasaki .....	142	Transmission Kits .....	195
Honda UTV .....	7	Honda .....	38	KTM .....	152	EST Shovelhead & Panhead .....	197
Kawasaki UTV .....	8	Husaberg .....	56	Polaris .....	152	EST EVO Sportster Motors .....	200
Polaris UTV .....	8	Husqvarna .....	57	Suzuki .....	152	Sportster & Buell	
Yamaha UTV .....	9	Kawasaki .....	62	Triumph .....	172	Iron Sportster Motor Kits .....	204
Arctic Cat ATV .....	11	KTM .....	82	Yamaha .....	172	Rotax 250/600, Victory .....	207
Can-Am/Bombardier ATV .....	12	LEM .....	102	Personal Watercraft .....	176	Karting Kits .....	208
Honda ATV .....	12	Suzuki .....	103	<b>HARLEY-DAVIDSON GASKETS</b>		KLOTZ Synthetic Lubricants .....	213
Kawasaki ATV .....	18	Yamaha .....	118	AFM Series Gaskets .....	178	Ison Racing Engine Services .....	215
KTM ATV .....	21	Water Pump Repair Kits .....	137	MLS Head & Base Gaskets .....	179	Cometic Apparel & Promo Items .....	215
Polaris ATV .....	22	Aprilia .....	138	EVO Rocker Cover Gaskets .....	180		
Outlaw ATV .....	24	Ducati .....	138	Milwaukee 8 .....	181		
Suzuki ATV .....	25	Honda .....	138	EST Twin Cam .....	186		
Yamaha ATV .....	27						

# Performance Powersports & V-Twin Products Available for:

Artic Cat  
Bombardier  
Cobra  
Gas Gas

Honda  
Husaberg  
Husqvarna  
Kawasaki

## Cometic Products

### Dirt | ATV | UTV | PWC

#### *Top-End Kits | Bottom-End Kits | Clutch and Mag Kits | Crank Seals | Individual Gaskets | Engine Seal Kits*

Today's lightweight engines are producing more horsepower, higher cylinder pressures, clamp loads and extreme temperatures. Our commitment is to provide innovative, quality gaskets while maximizing your engine's power and performance. Cometic's gaskets are proudly made in the USA with materials manufactured on American soil. We are constantly updating and adding models to our ever growing library of gaskets.

Be sure to check out our NEW Clutch and Mag Kits made from AFM Material. AFM will not stick to the engine case making replacement quick and easy, no more scraping. The aluminum core gives the gasket strength for a superior seal and prevents the gasket from weeping or crawling out. All gasket kits (Top-End, Bottom-End, Clutch and Mag) are sold with the proper amount of gaskets for one application. Need just one gasket, not the entire kit? No problem, we offer individual gaskets.

Cometic is a proud sponsor of Ricky Carmichael, Team Green, The Orange Brigade & Kawasaki Factory Motocross to name a few.

### Cycle Street

#### *Head Gaskets | Base Gaskets | Engine Case Kits*

For today's hi-horse power streetbikes, Cometic offers MLS head gaskets, base gaskets and engine case rebuild kits utilizing our best materials available! We have a complete line of streetbike applications from new to old.

Cometic is an industry leader in manufacturing processes and committed to pairing the highest possible quality materials with knowledgeable personnel. Cometic stays on the forefront of gasket design technology by utilizing in-house dynamometers and engine assembly rooms to bring its distributors, retailers and ultimately the end-user, the most reliable gaskets available today.



*Top-End Kit*

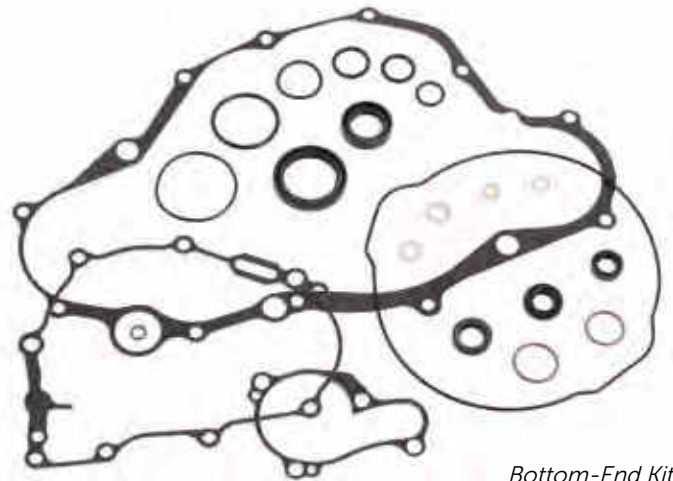

*Bottom-End Kit*



*MLS Head Gasket cross section*



KTM  
LEM  
Polaris  
Suzuki

Yamaha  
Can-Am Bombardier UTV  
Aprilia  
Ducati

Triumph  
Harley-Davidson  
Arctco  
Sea Doo

Ski-Doo  
John Deere  
Rotax

*Engine Seal Kits*



*V-Twin Kit*



*Clutch and Mag Kit*

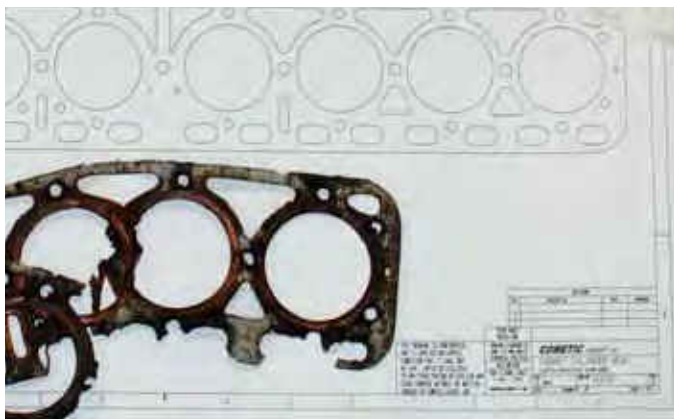
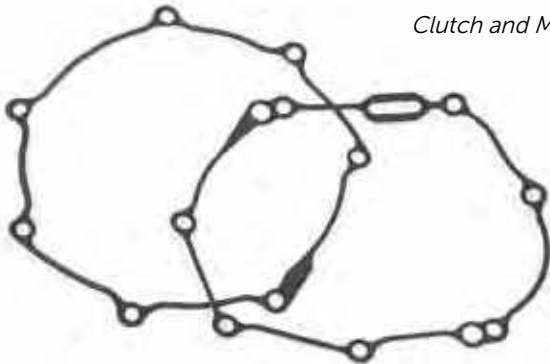

## Harley-Davidson® | V-Twin

**Head Gaskets | Base Gaskets | Engine Only Kits | Rocker Box Kits  
| Primary Kits | Transmission Kits**

Cometic Gasket has been servicing the American V-Twin Industry for over 25 years. Cometic offers a full line of gaskets for models from 1936 through current day models. Our gaskets can be ordered individually or as complete kits to do the entire job. Cometic also offers full on custom gaskets as well for shelf stock prices. So whether it's a stock bike or a fire breathing all out race machine Cometic has you covered.

All of Cometic's gaskets and seals have been tested on both the street and the track as well as vigorous Dyno shakedown. Rest assured every gasket has been methodically thought out before it is used in any application. Cometic uses it's EST "Extreme Sealing Technology" philosophy while making every gasket. Demand the best, Cometic to seal your engine.

## Snowmobile

**Complete Kits | Top-End Kits | Exhaust Kits | Intake Kits | Power Valve Kits | Crank Seal Kits**

Cometic's Snowmobile gaskets and gasket kits are used by professionals in high-performance machines and as OE replacements worldwide.

Cometic combines advanced materials with the most current manufacturing processes to provide custom-tailored solutions to meet the needs of each individual customer. Engineers analyze the environment in which the gasket will perform, select the proper material, and apply the appropriate technology to offer the best-performing gaskets available in today's ever-changing marketplace.

## Custom Gaskets

Need to change the bore size and/or thickness of a gasket? Or do you need a complete gasket design and execution?

The process starts with a simple phone call. After Cometic's in-house Technical Sales Team understands your needs, they work directly with our design engineers to insure the gasket is drawn with state-of-the-art software and manufactured with the best materials possible with the most current and efficient manufacturing processes. If special tooling is required, we'll provide a pre-production estimate for approval. Your gasket is then made and shipped. The lead-time on bore and thickness changes is just three days. A complete gasket design takes just two weeks.

Start with a simple phone call:  
(440) 354-0777 or (800) 752-9850



# UTV Gaskets



Cometic Gasket - An Exclusive NASCAR Performance® Product

## ARCTIC CAT UTV PROWLER 650



Base      Cam Chain      Clutch Cover      Head

Model	Year	Bore Size	Top End Kit	List Price	Component Part#	Component Description	List Price	OEM Part #
Prowler	06-09	98 mm	C7220	\$65.93	H1735SP3027S	Head Gasket 98mm Bore	\$35.72	0830-124
650		100 mm	C7022	\$65.93	H1735SP4027S	Head Gasket 100mm Bore	\$35.72	0830-124
					B0647014RC	Base Gasket	\$6.19	0830-084
					EX657	Exhaust Gasket	\$9.37	0412-338
					EC377032AFM	Cam Chain Tens. Gasket	\$3.35	0830-018
					OS020	2 Req.-Cam Chain Tens. O-ring	\$1.03	0830-107
					R22X2.5V	Coolant Line O-ring	\$2.21	0830-007
					R45X3V	Intake O-ring	\$2.71	0830-090
					R54X2V	2 Req.-Valve Cover O-rings	\$4.14	0830-004

**Bottom End Gaskets Available Separately**

Component Part#	Component Description	List Price	OEM Part #
EC1142032AFM	Clutch Cover Gasket	\$30.95	0830-116
EC1143032AFM	Magneto Cover Gasket	\$24.98	0830-128
EC1141032AFM	Primary Cover Gasket	\$35.72	0830-174

## PROWLER 700XT LTD

Model	Year	Bore Size	Top End Kit	List Price	Component Part#	Component Description	List Price	OEM Part #
Prowler	08-15	103.5mm	C3597-EST	\$5.93	H2223SP4027S	Head Gasket	\$26.52	0830-112
700 XT LTD					B0760014RC	Base Gasket	\$5.54	0830-111
X700	11-17				EX657	Exhaust Gasket	\$6.19	0412-338
					OS020	Cam Chain Tensioner Gasket	\$1.03	0830-107
					EC377032AFM	Cam Chain Tens. Gasket	3.35	0830-018
					3186V	Valve Seals	\$4.99	0830-186
					R22X2.5V	Water Outlet O-ring	\$2.21	0830-007
					R124V	Valve Cover O-rings 2 req.	\$1.19	0830-215
					R008B	Intake O-ring	\$0.11	0423-182
					R124V	Oil Fill Cap O-ring	\$1.19	0830-215
					R54X2V	Inspection Cap O-ring	\$4.14	0830-004

**Bottom End Gaskets Available Separately**

Component Part#	Component Description	List Price	OEM Part #
EC1142032AFM	Clutch Cover Gasket	\$30.95	0830-116
EC1143032AFM	Magneto Cover Gasket	\$24.98	0830-128
EC1141032AFM	Primary Cover Gasket	\$35.72	0830-174

## PROWLER/WILDCAT 1000

Model	Year	Bore Size	Top End Kit	List Price	Component Part#	Component Description	List Price	OEM Part #
Prowler/	10-17	93.5mm	C3568-EST	\$126.58	H2399SP6027S	Head Gasket	\$30.58	0830-209
Wildcat 1000					B1155014RC	Base Gasket	\$19.61	0830-193
					EX657	Exhaust Gasket	\$0.00	0412-338
					EC2035032AFM	Cam Chain Tensioner Gasket 2 Req.	\$3.35	0830-134
					3186V	Valve Seals 8 Req.	\$4.99	0830-186
					R118V	Water Outlet O-ring	\$1.13	0830-007
					OS384	Water Inlet Seal	\$5.08	0830-120
					R54X2V	Valve Cover O-rings 4 req.	\$4.14	0830-004
					R45X3V	Intake O-ring 2 req.	\$2.71	0830-090

**All Component Parts can be purchased individually.**



**WARNING:** Cancer and Reproductive Harm [www.P65Warnings.ca.gov](http://www.P65Warnings.ca.gov)



# UTV Gaskets



Cometic Gasket - An Exclusive NASCAR Performance® Product

## CAN-AM/BOMBARDIER UTV COMMANDER 1000



Head



Base

Model	Year	Bore Size	Top End Kit	List Price	Component Part#	Component Description	List Price	OEM Part #
Commander	11-16	92mm	C3459-EST	\$155.00	H2653018S	Head Gasket 92mm 2 Req.	\$44.55	420630195
1000		93mm	C3460-EST	\$155.00	H2653SP1018S	Head Gasket 93mm 2 Req.	\$44.55	
Maverick	13-15	94mm	C3461-EST	\$155.00	H2653SP2018S	Head Gasket 94mm 2 Req.	\$44.55	
		96mm	C3462-EST	\$155.00	H2653SP5018S	Head Gasket 95mm 2 Req.	\$44.55	
					3186V	Valve Stem Seal 8 Req.	\$4.99 ea.	420230515
					R117V	Cam Chain Tensioner O-ring	\$1.19	420430370
					R15X1.5V	Cam Adjuster O-ring	\$1.13	420250890
					EX696	Header Gasket 2 Req.	\$10.28	707600317
					B0895010RC	Base Gasket 2 Req.	\$15.24	420630210

### Bottom End Gaskets Available Separately

Component Part#	Component Description	List Price	OEM Part #
EC1142032AFM	Clutch Cover Gasket	\$30.95	0830-116
EC1143032AFM	Magneto Cover Gasket	\$24.98	0830-128
EC1141032AFM	Primary Cover Gasket	\$35.72	0830-174

## HONDA UTV FL250 ODYSSEY

Model	Year	Bore Size	Top End Kit	List Price	Component Part#	Component Description	List Price	OEM Part #
FL250	73-77	72 mm	C7140	\$25.55	H0182043F	Head Gasket 72mm	\$19.28	12251-358-306
Odyssey					B0137020F	Base Gasket 73-76	\$6.25	12191-357-306
					B0395020F	Base Gasket 77-84	\$5.34	12191-381-306

## FL350R ODYSSEY

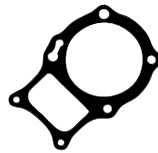

Base

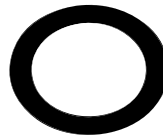

Exhaust



Head

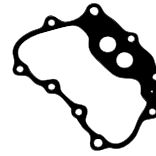

Valve Cover

Model	Year	Bore Size	Top End Kit	List Price	Component Part#	Component Description	List Price	OEM Part #
FL350R	85	82 mm	C7229	\$31.91	B0204020F	Base Gasket	\$7.16	12191-VMO-772
Odyssey					H0344043F	Head Gasket	\$22.32	12254-VMO-013

## PILOT FL-400



Exhaust

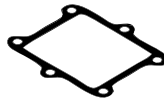

Intake

Model	Year	Bore Size	Top End Kit	List Price	Component Part#	Component Description	List Price	OEM Part #
Pilot	89-91	82 mm	C7024	\$35.72	H0015043F	Head Gasket	\$22.32	12251-HE0-000
FL-400					B0020020F	Base Gasket	\$6.25	12191-HE0-000/010
					EX009042AM	Exhaust Gasket	\$4.65	18291-HE0-000/010
					IR004018AFM	Intake Gasket	\$3.80	14132-KAE-000/430-000

**All Component Parts can be purchased individually.**



**WARNING:** Cancer and Reproductive Harm [www.P65Warnings.ca.gov](http://www.P65Warnings.ca.gov)



# UTV Gaskets



Cometic Gasket - An Exclusive NASCAR Performance® Product

## KAWASAKI UTV

### KRF750 Teryx

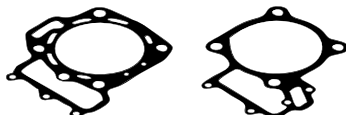

Head

Base

Model	Year	Bore Size	Top End Kit	List Price	Component Part#	Component Description	List Price	OEM Part #
KRF750	08-14	85mm	C3284-EST	\$122.60	H2624SPA010S	Head Gasket 85mm	\$28.29	11004-0011
Teryx (SXS)		90 mm	C3251-EST	\$122.60	H2624SP1010S	Head Gasket 90mm	\$28.29	11004-0011
					B0951020RC	Base Gasket	\$9.94	11061-0063
					EX361	Exhaust Gasket 2 req	\$5.50	11009-1894
					WA114	Coolant Drain Washer 2 Req	\$3.02	
					R55X2V	Rocker Cap O-Ring 4 Req	\$2.34	92055-0112
					R19X2V	Plug Cover O-Ring 2 Req	\$2.50	92055-1146
					3242V	Valve Stem Seals 8 Req	\$3.02	92049-1218

## POLARIS UTV

### RZR170



Exhaust

Head

Model	Year	Bore Size	Top End Kit	List Price	Component Part#	Component Description	List Price	OEM Part #
RZR170	09-16	61mm	C3596-EST	\$49.84	B1318020RC	Cylinder Base Gasket	\$2.17	0454459
					H4194010S	Cylinder Head Gasket	\$19.99	0454365
					IR1308020F	Intake Manifold Gasket	\$2.95	0453451
					R024V	Intake Manifold O-ring	\$1.19	0452459
					R049B	Cylinder Head Cover O-ring	\$2.97	0454363
					EC2131032AFM	Cylinder Head Breather	\$4.79	0454640
					EC2132060AFM	Air Injection Gasket	\$2.39	0452808
					EC2133060AFM	Air Injection Tube Gasket	\$2.39	0454454
					EX886042AM	Exhaust Gasket	\$4.30	0453672
					3234V	Valve Seal	\$5.50	0452390
					EC2134032AFM	Cam Chain Tensioner Gasket	\$1.24	0452417

### RZR 570

Model	Year	Bore Size	Top End Kit	List Price	Component Part#	Component Description	List Price	OEM Part #
RZR 570	12,14-18	99mm	C3528-EST	\$79.02	B1171014RC	Base Gasket	\$19.29	5254903
					H3609021S	Head Gasket 99mm Bore	\$34.27	5813676
					3231V	Valve Seals 4 Req.	\$6.48 ea.	3610161
					EX817	Exhaust Gasket	\$11.28	5253989
					3254V	Valve Spring Seat With Seal	\$5.21	3610212
					EC1654020RC	Cam Chain Tensioner	\$3.52	5813449

### RANGER RZR 800 (SXS)

Model	Year	Bore Size	Top End Kit	List Price	Component Part#	Component Description	List Price	OEM Part #
Ranger	08	80 mm	C3250	\$70.96	H2761030S	Head Gasket 80mm Bore	\$51.73	5247359
RZR 800 (SXS)		82 mm	C3507	\$70.96	H2761SP2030S	Head Gasket 82mm Bore	\$51.73	
					B0940010RC	Base Gasket	\$11.60	5247360
					EX452SP1064AM	Exhaust Gasket	\$15.51	5811511

### RANGER RZR 800 (SXS)

Model	Year	Bore Size	Top End Kit	List Price	Component Part#	Component Description	List Price	OEM Part #
Ranger	11-13	80 mm	C3506	\$70.96	H3657010S	Head Gasket 80mm Bore	\$51.73	5254357
RZR 800 (SXS)		82 mm	C3508		H3657SP2010S	Head Gasket 82mm Bore	\$51.73	
					B0940010RC	Base Gasket	\$11.60	5247360
					EX452SP1064AM	Exhaust Gasket	\$15.51	5811511

All Component Parts can be purchased individually.



**WARNING:** Cancer and Reproductive Harm [www.P65Warnings.ca.gov](http://www.P65Warnings.ca.gov)





# UTV Gaskets



Cometic Gasket - An Exclusive NASCAR Performance® Product

## POLARIS UTV

### XP900

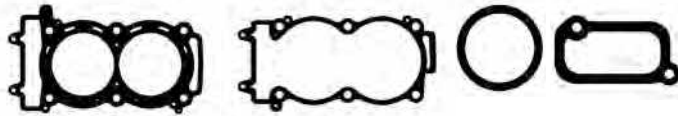

Head Base Cam Chain Tensioner Water Inlet

Model	Year	Bore Size	Top End Kit	List Price	Component Part#	Component Description	List Price	OEM Part #
XP900	11-14	93.5mm	C3446-EST	\$85.66	H3336018S	Head Gasket 93.5mm Bore	\$34.27	5813439
		96mm	C3447-EST	\$85.66	H3336SP1018S	Head Gasket 93.5mm Bore	\$34.27	
					B1079014RC	Base Gasket	\$19.29	5253037
					EC1654020RC	Cam Chain Tensioner	\$3.52	5813449
					WP383032AFM	Water Inlet Gasket	\$3.74	5813521
					EX817	Exhaust Gasket 2 req.	\$11.28	5253989
					3231V	Valve Seals 8 Req.	\$6.48 ea.	3610161

### XP1000

Model	Year	Bore Size	Top End Kit	List Price	Component Part#	Component Description	List Price	OEM Part #
RZR XP1000	14-19	94mm	C3546-EST	\$85.66	H3892018S	Head Gasket 94mm Bore	\$34.27	5813737
RZR XP4 1000		96mm	C3563-EST	\$85.66	H3892SP1018S	Head Gasket 96mm Bore	\$34.27	5813737
900 Ace,	16-19				B1079014RC	Base Gasket	\$9.29	5253037
General 1000					EC1654020RC	Cam Chain Tensioner Gasket	\$3.52	5813449
Ranger 1000	18-19				EX1408064AM	Header Gasket	\$12.20	3610184
RZR 1000	16-19				3254V	Valve Spring Seat With Seal	\$5.21	3610212
RZR XP	16-19				MR135	Thermostat Seal	\$4.00	5413948
Turbo					MR136	Water Outlet O-ring	\$10.99	5813736

## YAMAHA UTV

### RHINO 660

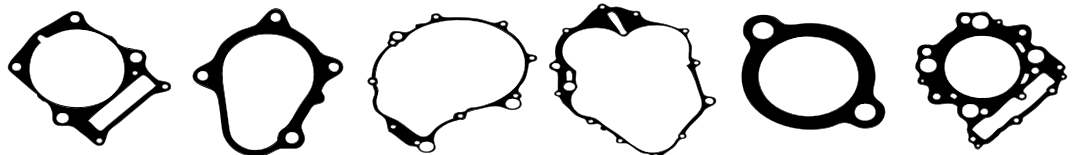

Base Starter Cover Mag Cover Clutch Cover Timing Chain Tensioner Head

Model	Year	Bore Size	Top End Kit	List Price	Component Part#	Component Description	List Price	OEM Part #
RHINO 660 (SXS)	04-07	100 mm	C7044-EST	\$89.44	H1481SP2030S	Head Gasket 100mm	\$27.26	3YF-11181-00
		101 mm	C7900-EST	\$89.44	H1481030S	Head Gasket 101mm	\$27.26	
		102 mm	C7798-EST	\$89.44	H1191030S	Head Gasket 102mm	\$27.26	
		103 mm	C3042-EST	\$89.44	H2174030S	Head Gasket 103mm	\$27.26	
		105 mm	C7909-EST	\$89.44	H1191SP1030S	Head Gasket 105mm	\$27.26	
					B0532010RC	Base Gasket	\$8.69	3YF-11351-00
					EX361	Exhaust Gasket 2 Req.	\$5.50	3YF-14613-01-00
					EC584018AFM	Cam Chain Tensioner Gasket	\$3.58	4DW-12213-00
					3187V	Valve Seal 5 Req.	\$3.02	5H0-12119-00-00
					R016B	Radiator Hose O-ring	\$0.74	93210-18417-00
					R113B	Valve Cover Plug O-ring	\$1.19	93210-13657-00
					R114S	Oil Tank O-ring	\$3.92	93210-16629-00
					R116B	Cam Chain Tensioner Cap O-ring	\$1.13	11101/93210-19522-00
					R117B	Dipstick O-ring	\$0.42	93210-21190-00
					R124B	Tappet Cover O-ring	\$3.92	93210-32172-00
					R155S	Cylinder Base O-ring	\$3.92	11256/93211-01467-00
					R71X2.5B	Intake Valve Adj. Cover O-ring	\$2.57	93210-71360-00
					WA081080C	Oil Line Washers 4 Req.	\$0.57	90430-08204
					WA082063C	Oil line Washers 4 Req.	\$1.93	90430-10171

All Component Parts can be purchased individually.



**WARNING:** Cancer and Reproductive Harm www.P65Warnings.ca.gov



# UTV Gaskets



Cometic Gasket - An Exclusive NASCAR Performance® Product

## YAMAHA UTV

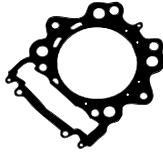

Base      Timing Chain Tensioner      Head

Model	Year	Bore Size	Top End Kit	List Price	Component Part#	Component Description	List Price	OEM Part #
RHINO 700	06-13	103 mm	C3142-EST	\$89.44	H2449027S	Head Gasket	\$40.55	3B4-11181-00-00
		104 mm	C3143-EST	\$89.44	H2449SP2027S	Head Gasket 104mm Bore	\$40.55	3B4-11181-00-00
		105.5 mm	C3144-EST	\$89.44	H2465027S	Head Gasket 105.5mm Bore	\$40.55	3B4-11181-00-00
					B0855010RC	Base Gasket	\$9.47	1S3-11351-00-00
					EX361	Exhaust Gasket 2 Req.	\$5.50	3YF-14613-01-00
					R034V	Throttle Body O-ring	\$3.00	4WV-14147-10-00
					R126V	Water Pump O-ring	\$1.19	93210-33786-00
					R131B	Thermostat O-ring	\$1.13	93210-41042-00
					R240V	Cam Cover O-ring	\$3.92	93210-96601-00
					R79X2.5V	Valve Cover O-rings 2 Req.	\$7.29	93210-78544-00
					3187V	Valve Seal 4 Req.	\$3.02	5H0-12119-00-00
					EC584018AFM	Cam Chain Tensioner Gasket	\$3.58	4DW-12213-00

### WOLVERINE R-SPEC YXE700

Model	Year	Bore Size	Top End Kit	List Price	Component Part#	Component Description	List Price	OEM Part #
Wolverine Spec YXE700	2016	103mm	C3599-EST	\$64.58	EC2098032AFM	Cam Chain Tensioner Gasket	\$2.46	2MB-E2213-00-R-00
					MA0164	Cam Chain Tensioner	\$0.93	2MB-E21E2-00-00
					B1306010RC	Cylinder Base Gasket	\$9.47	2MB-E1351-00-00
					H4173023S	103mm Bore Head Gasket	\$40.55	2MB-E1181-00-00
					VC362018AFM	Valve Cover Breather Gasket	\$4.02	2MB-E131B-00-00
					EX045	Header Gasket	\$4.26	3EG-14613-00-00
					WA117	Oil Line Banjo Bolt	\$0.95	2MB-E1195-00-00
						Crush Gaskets		
					3187V	Exhaust Valve Seal	\$1.48	2MB-E2129-00-00
					3187V	Intake Valve Seal	\$1.48	2MB-E2119-00-00
					R125V	Water Outlet O-ring	\$1.19	2MB-E2843-00-00

### YXZ1000R

Model	Year	Bore Size	Top End Kit	List Price	Component Part#	Component Description	List Price	OEM Part #
YXZ1000R	2016	82.5mm	C3617	\$100.55	EC1152032AFM	Cam Chain Tensioner Gasket	\$2.33	2C0-12213-00-00
					R116B	Fill Plug O-ring	\$1.13	93210-19123-00
					WA116	Cylinder Head Drain Plug	\$1.06	90430-08119-00
						Crush Washer		
					H4270016S	Cylinder Head Gasket	\$62.63	2HC-11181-00-00
					EX651	Exhaust Gasket 3 Req.	\$8.98	4FM-14613-00-00
					3168V	Valve Stem Seal 12 Req.	\$1.47	2HC-12119-00-00



# ATV Gaskets



Cometic Gasket - An Exclusive NASCAR Performance® Product

## ARCTIC CAT DVX400

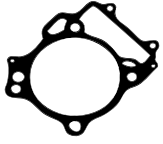

Base



Cam Chain



Clutch Cover



Head

Model	Year	Bore Size	EST Top End Kit	List Price	Component Part#	Component Description	List Price	OEM Part #
DVX400	03-08	92mm	C7978-EST	\$64.23	H0949027S	Head Gasket 92mm	\$30.95	3402-841
		94mm	C7979-EST	\$64.23	H1045027S	Head Gasket 94mm	\$30.95	
		96mm	C3138-EST	\$64.23	H1045SP2027S	Head Gasket 96mm	\$30.95	
		97mm	C7980-EST	\$64.23	H1046027S	Head Gasket 97mm	\$30.95	
					B0440027S	Base Gasket	\$28.51	3402-844
					EC377032AFM	Cam Tensioner Gasket	\$3.35	3402-137
					EX243	Exhaust Gasket	\$2.79	3512-007
					WA121	Oil Drain Bolt Gasket	\$0.80	3003-290
					3160V	Valve Stem Seals 4 Req	\$5.50	3402-078
					EC1030032AFM	Clutch Cover Gasket	\$20.22	3446-357

Model	Year	Bore Size	EST Top End Kit	List Price	Component Part#	Component Description	List Price	OEM Part #
650 H1	05-12	98 mm	C7220-EST	\$65.93	H1735SP3027S	Head Gasket 98mm Bore	\$35.72	0830-124
650 TRV	09	100 mm	C7022-EST	\$65.93	H1735SP4027S	Head Gasket 100mm Bore	\$35.72	0830-124
650 TBX	09				B0647014RC	Base Gasket	\$6.19	0830-084
650 4x4	10				EX657	Exhaust Gasket	\$9.37	0412-338
650 Mud Pro	10-11				EC377032AFM	Cam Chain Tens. Gasket	\$3.35	0830-018
					OS020	2 Req.-Cam Chain Tens. O-ring	\$1.03	0830-107
					R22X2.5V	Coolant Line O-ring	\$2.21	0830-007
					R45X3V	Intake O-ring	\$2.71	0830-090
					R54X2V	2 Req.-Valve Cover O-rings	\$4.14	0830-004

Model	Year	Bore Size	EST Top End Kit	List Price	Component Part#	Component Description	List Price	OEM Part #
Mud Pro	09-17	103.5mm	C3597-EST	\$65.93	H2223SP4027S	Head Gasket	\$26.52	0830-112
700 H1 EFI					B0760014RC	Base Gasket	\$5.54	0830-111
700 EFI	10-11				EX657	Exhaust Gasket	\$6.19	0412-338
TRV 700	09-15				OS020	Cam Chain Tensioner Gasket	\$1.03	0830-107
Alterra 700	2017				EC377032AFM	Cam Chain Tens. Gasket	\$3.35	0830-018
TBX 700	12-17				3186V	Valve Seals	\$4.99	0830-186
XR700	2015				R22X2.5V	Water Outlet O-ring	\$2.21	0830-007
700XT	13-14				R124V	Valve Cover O-rings 2 req.	\$1.19	0830-215
					R008B	Intake O-ring	\$0.01	0423-182
					R124V	Oil Fill Cap O-ring	\$1.19	0830-215
					R54X2V	Inspection Cap O-ring	\$4.14	0830-004

Model	Year	Bore Size	EST Top End Kit	List Price	Component Part#	Component Description	List Price	OEM Part #
1000 XT	16-17	93.5mm	C3568-EST	\$126.58	H2399SP6027S	Head Gasket 2 req	\$30.58	0830-209
EPS					B1155014RC	Base Gasket 2 req	\$19.61	0830-193
Mud Pro	16-17				EC377032AFM	Cam Chain Tens. Gasket 3 Req	\$3.35	0830-018
1000 Limited					R118V	Water Outlet O-ring	\$1.13	0830-007
EPS					EX657	Exhaust Gasket 2 Req	\$9.37	0412-338
					3186V	Valve Stem Seal 8 Req.	\$4.99	0830-186
					R012B	Head Drain O-ring	\$0.51	0830-213
					R54X2V	Tappet Cover O-ring	\$4.14	0830-004
					OS384	Thermostat Seal	\$5.08	0830-120
					R45X3V	Intake O-ring 2 req.	\$2.71	0830-090

All Component Parts can be purchased individually.



**WARNING:** Cancer and Reproductive Harm www.P65Warnings.ca.gov







# ATV Gaskets



Cometic Gasket - An Exclusive NASCAR Performance® Product

## HONDA TRX90

Model	Year	Bore Size	EST Top End Kit	List Price	Component Part#	Component Description	List Price	OEM Part #
TRX90	93-16	50 mm	C7226-EST	\$71.49	H2710040S B0659020RC 3234V EC1070018AFM EC1071018AFM EC1072018AFM R027B R14X2.5V R16X2V R9X2V	Head Gasket Base Gasket Valve Stem Seals 2 Req. Right Head Cover Left Head Cover Center Head Cover Valve Cap O-rings 2 Req. Oil Return O-ring Base O-ring Valve Guide O-rings 2 Req.	\$24.75 \$7.16 \$5.50 ea. \$2.33 \$2.33 \$4.72 \$0.74 \$1.13 \$3.02 \$1.59	12251-GB5-811 12191-GW8-681 12209-GB4-681 12394-GW8-680 12395-GW8-680 12391-GW8-680 91302-001-020 91301-GF6-003 91303-035-000 91305-028-900
TRX125	85-86	55 mm	C7224	\$29.42	H0332020C B0195043F	Head Gasket Base Gasket	\$15.85 \$10.68	12250-VM6-003 12191-VM6-306
TRX125	87-88	57 mm	C7223	\$25.55	H0331043F  B0021020F	Head Gasket  Base Gasket	\$18.56  \$5.34	12251-HB6-000/405 12191-KT0-710
ATC185	80-83	67 mm	C7025	\$25.55	H0016043F B0021020F B0164020F	67mm Bore Head Gasket Base Gasket ATC 185-200 Base Gasket ATC 200ES Models	\$19.82 \$5.34 \$5.63	12251-4B6-405 12191-KT0-710
ATC200	81-83							
ATC200E	82-83							
ATC200ES	84							
ATC200M	84-85							
ATC200S	85-86							
ATC200X	83-85							
TRX200	84							
ATC200X	86-87	67 mm	C7222	\$25.55	H0335SP1043F B0168020F	Head Gasket 67mm Bore Base Gasket	\$18.56 \$6.25	12251-HB3-003 12191-HFI-910
TRX200	90-95							
TRX200SX	86-88							
ATC250R	81-84	72 mm	C7021	\$35.72	H0014043F B0018020F IR004018AFM	Head Gasket Base Gasket Intake Gasket	\$19.82 \$6.25 \$3.80	12254-961-010 12191-961-306 14132-430-000
ATC250R	85-86	68 mm 69.5 mm 72 mm	C7349 C7350 C7351	\$40.88 \$40.88 \$40.88	H0009010S H0195010S H0196010S B0019020F IR004018AFM IR005018AFM	Head Gasket 68mm Head Gasket 69.5mm Head Gasket 72mm Base Gasket Intake Gasket Cylinder to Reed Intake Gasket Reed Block to Intake Manifold	\$28.51 \$28.51 \$28.51 \$6.25 \$3.80 \$3.80	12254-KS7-881   12191-HA2-306 14132-430-000 14133-430-000
			Bottom End Kit w/Oil Seals C7349BE	\$66.70	EC313020F WP071018AFM WA133 R020V R16X3V R141SB WA137	Crankcase Gasket Water Pump Gasket Water Pump Drain Plug Output Shaft O-ring Fill Plug O-ring Balancer Shaft O-ring Drain Plug Gasket	\$10.90 \$2.38 \$0.90 \$1.19 \$1.26 \$18.99 \$1.15	11191-HA2-306 19229-HA2-306 90543-273-000 91201-430-003 91303-800-000 91308-500-010 94109-12000
			Oil Seal Kit C7349OS	\$37.60	OS106 OS227 OS197 OS108 OS239 OS244 OS173	Right Crank Seal Water Pump Seal Shift Shaft Seal Left Crank Seal Start Shaft Seal Clutch Pushrod Seal Output Shaft Seal	\$10.68 \$2.67 \$2.46 \$9.47 \$2.60 \$1.43 \$8.29	91201-KA4-004 91201-965-000 91202-444-023 91202-HA2-771 91204-KF0-003 91206-VA3-J02 91207-ML3-003
			Clutch & Mag Kit C7349CM	\$21.91	EC311032AFM EC312060AFM	Clutch Cover Gasket Mag Cover Gasket	\$13.62 \$8.29	11395-HA2-P00 11352-HA2-306

All Component Parts can be purchased individually.



WARNING: Cancer and Reproductive Harm www.P65Warnings.ca.gov



# ATV Gaskets



Cometic Gasket - An Exclusive NASCAR Performance® Product

## HONDA ATC250ES

Model	Year	Bore Size	Top End Kit	List Price	Component Part#	Component Description	List Price	OEM Part #
ATC250ES	85-87	76 mm	C7026-EST	\$25.55	H4633SP1027S	Head Gasket	\$27.26	12251-HA0-004
ATC250SX	85-87				B0022020F	Base Gasket	\$6.25	12191-HA7-921
TRX250	85-87				EC036018AFM	Cam Chain Tensioner	\$2.04	12194-HC5-740
TRX300	85-01				MA0164	Cam Chain Crush Washer	\$0.93	90442-397-000
					3231V	Valve Stem Seal	\$6.48	12209-KL4-005
					R7X2.5B	Rocker Arm O-rings 7.7x2.5	\$3.43	91303-428-003
					R78X2V	Cylinder Base O-ring 78.3x2	\$4.29	91304-HA0-003
					WA116	Oil line Crush Washer )3( 7mm	\$1.06	90441-MC0-000
					R57X2V	Tappet Cover O-ring (2)	\$3.20	12392-HC4-005
					R10X2V	Valve Guide O-ring 10x 1.6 (2)	\$1.59	91301-200-000
					R126V	Intake O-ring 33.7x2.4	\$1.10	91305-HA0-680
					EX651	Header Gasket	\$8.98	18291-MN4-920
			<b>EST Top End Kit</b>	<b>List Price</b>	<b>Component Part#</b>	<b>Component Description</b>	<b>List Price</b>	<b>OEM Part #</b>
TRX250EX	01-16	70mm	C3153-EST	\$77.46	H2473010S	Head Gasket	\$17.32	12251-HN6-000
TRX250TE	02-17				3231V	3231V Valve Seals 4 Req.	6.48 ea.	12209-KL4-005
TRX250TM	02-17				B0846020RC	Base Gasket	\$11.87	12191-HM8-000
TRX250X	2016				EX691064AM	Exhaust Gasket	\$4.20	18291-MN5-650
					R10X2V	Valve Guide O-ring 2 req.	\$1.59	91301-200-000
					R219V	Tappet Cover O-rings 2 Req.	\$3.92	12392-HC4-005
					R8X2V	Rocker Shaft O-rings 2 Req.	\$1.13	91303-428-003
					<b>Component Part#</b>	<b>Component Description</b>	<b>List Price</b>	<b>OEM Part #</b>
					VC135018AFM	Valve Cover Gasket	\$11.87	12315-HN6-010
					EC1092032AFM	Clutch Cover Gasket	\$23.85	11394-HM8-000
			<b>EST Top End Kit</b>	<b>List Price</b>	<b>Component Part#</b>	<b>Component Description</b>	<b>List Price</b>	<b>OEM Part #</b>
TRX250X	87-92	75 mm	C7143-EST	\$80.99	H2475027S	75mm Bore Head Gasket	\$27.26	12251-HC0-013
		78 mm	C7906-EST	\$80.99	H2475SP2027S	78mm Bore Head Gasket	\$27.26	12251-HC0-013
					3231V	Valve Seals 4 Req.	6.48 ea.	12209-KL4-005
					B0165020F	Base Gasket	\$6.25	12191-HM3-670
					EC036018AFM	Cam Chain Tensioner Gasket	\$2.04	12194-HC5-740
					R10X2V	Valve Guide O-ring 4 req.	\$1.59	91301-200-000
					R35X3V	Intake Manifold O-ring	\$3.64	91305-HA5-000
					R57X2V	Tappet Cover O-ring	\$3.20	12392-HC4-005
					R78X2V	Base O-ring	\$4.29	91302-428-000
					R7X2.5B	Rocker Shaft O-rings 2 Req.	\$3.43	91303-428-003
					<b>Component Part#</b>	<b>Component Description</b>	<b>List Price</b>	<b>OEM Part #</b>
					C7712	Clutch Cover Gasket	\$12.78	11395-HA2-003
			<b>EST Top End Kit</b>	<b>List Price</b>	<b>Component Part#</b>	<b>Component Description</b>	<b>List Price</b>	<b>OEM Part #</b>
Fourtrax	92-09	75 mm	C7143-EST	\$80.99	H2475027S	75mm Bore Head Gasket	\$27.26	12251-HC0-013
TRX300EX		78 mm	C7906-EST	\$80.99	H2475SP2027S	78mm Bore Head Gasket	\$27.26	12251-HC0-013
		80 mm	C7525-EST	\$80.99	H2475SP3027S	80mm Bore Head Gasket	\$27.26	12251-HC0-013
		81 mm	C7527-EST	\$80.99	H2475SP5027S	81mm Bore Head Gasket	\$27.26	12251-HC0-013
					B0165020F	Base Gasket	\$6.25	12191-HM3-670
					3231V	Valve Seals 4 Req.	\$6.48 ea.	12209-KL4-005
					EC036018AFM	Cam Chain Tensioner Gasket	\$2.04	12194-HC5-740
					R10X2V	Valve Guide O-ring 4 req.	\$1.59	91301-200-000
					R35X3V	Intake Manifold O-ring	\$3.64	91305-HA5-000
					R57X2V	Tappet Cover O-ring	\$3.20	12392-HC4-005
					R78X2V	Base O-ring	\$4.29	91302-428-000
					R7X2.5B	Rocker Shaft O-rings	\$3.43	91303-428-003
			<b>Bottom End Kit w/o crank seals</b>	<b>List Price</b>	<b>Component Part#</b>	<b>Component Description</b>	<b>List Price</b>	<b>OEM Part #</b>
			C3332	\$47.58	C7712	Clutch Cover Gasket	\$12.78	11395-HA2-003
					EC309020F	Starter Cover Gasket	\$12.39	11356-HM3-670
					EC310020F	Centercase Gasket	\$22.32	11191-HM3-670
					EC308020F	Mag Cover Gasket	\$12.39	11395-HM3-670
			<b>Top End Kit</b>	<b>List Price</b>	<b>Component Part#</b>	<b>Description</b>	<b>List Price</b>	<b>OEM Part#</b>
ATC350X	85-86	82 mm	C7402	\$37.19	H2043027S	Head Gasket 82mm Bore	\$30.95	12251-HA0-003/004/005
TRX350, D	86-89	86 mm	C7405	\$37.19	H2044027S	Head Gasket 86mm Bore	\$30.95	12251-HA0-003/004/005
					B0199020F	Base Gasket	\$9.94	12191-HA7-921





# ATV Gaskets



Cometic Gasket - An Exclusive NASCAR Performance® Product

## HONDA TRX350ES

Model	Year	Bore Size	Top End Kit	List Price	Component Part#	Component Description	List Price	OEM Part #
TRX350ES	00-06	80mm	C3690	\$37.29	VC057018AFM	Valve Cover Gasket	\$8.29	12315-HN5-671
TRX350FM					H1187010S	Head Gasket	\$24.75	12251-HN5-671
Fourtrax Rancher					B0573020F	Base Gasket	\$12.39	12191-HN5-670
TRX350TE					EX651	Exhaust Gasket	\$8.98	18291-MN4-920
TRX350TM					R126V	Intake Gasket	\$1.10	91305-HN5-671
Fourtrax Rancher					R8X2V	Cam Tower O-ring	\$1.13	91303-428-003
					3231V	Valve Stem Seal	\$6.48	12209-KL4-005
					R10X2V	Valve Guide O-rings	\$1.59	91301-200-000

		EST	List Price	Component Part#	Component Description	List Price	OEM Part #
		<b>Top End Kit</b>					
TRX400EX	05-08	86 mm	C7825-EST	H0401027S	Head Gasket 86mm .027"	\$27.26	12251-KCY-671
TRX400EX	96-04	87 mm	C7924-EST	H0401SP2027S	Head Gasket 87mm .027"	\$27.26	
TRX400X	09-14	89 mm	C7826-EST	H0402027S	Head Gasket 89mm .027"	\$27.26	12251-KCY-67
				B0244020RC	Base Gasket .020"	\$12.39	12191-KCY-671
				R88X2B	Cylinder Base O-ring	\$1.36	91302-356-000
				EX691064AM	Exhaust Gasket 2 Req.	\$4.20	18291-MN5-650
				EC578020RC	Cam Chain Tensioner Gasket	\$5.50	14523-KBB-901
				R10X2V	Valve Guide O-Ring	\$1.59	91301-200-000
				3231V	Valve Seals 4 Req.	6.48 ea.	12209-KL4-005
				R011V	Cam Chain Tensioner O-ring	\$1.13	91306-MG3-000
				R127V	Valve Adj. Cap O-rings 4 Req.	\$3.92	91301-428-003
				R132V	Intake Manifold O-ring	\$1.19	91301-679-003
				R219V	Exhaust O-ring	\$3.92	18291-MN5-650
				R45.5X2.5V	Intake O-ring	\$2.34	91303-397-000
		<b>Bottom End Kit</b>	<b>List Price</b>	<b>Component Part#</b>	<b>Component Description</b>	<b>List Price</b>	<b>OEM Part #</b>
		C3342	\$44.67	EC1222020F	Center Case Gasket	\$22.66	11191-HN1-A40
				C7714	Clutch Cover Gasket	\$14.87	11394-KCY-671
				EC361020F	Mag Cover Gasket	\$14.87	11395-KCY-671
				EC363020F	Clutch Cover Gasket 05-14	\$2.38	11377-HN1-000
		<b>Bottom End Kit</b>	<b>List Price</b>	<b>Component Part#</b>	<b>Component Description</b>	<b>List Price</b>	<b>OEM Part #</b>
		<b>w/o crank seals</b>					
TRX400EX	1999-2004	C7825BE	\$81.38	EC362020F	Center Case Gasket	\$14.87	11191-HN1-000
				EC363032AFM	Starter Cover Gasket	\$2.38	11377-HN1-000
				WA129	Oil Tank Drain Plug Washer	\$0.95	90441-425-000
				WA130	Oil Pump Drain Washer	\$1.36	90463-ML7-000
				R18X3V	Oil Tank Dipstick O-ring	\$1.71	91302-KE8-003
				R54X2.5	Oil Filter O-ring	\$11.34	91302-KF0-003
				R114B	Timing Mark O-ring	\$1.13	91303-377-000
				R214V	Oil Tank Strainer O-ring	\$1.19	91305-384-750
				R27X2V	Crank End O-ring	\$1.86	91305-KF0-003
				R013V	Oil line O-ring	\$1.08	91305-PE2-003
				R214V	Starter Motor O-ring	\$1.19	91312-MG7-003
				R112V	Oil line O-ring	\$1.19	91314-HN6-000
				WA137	Drain Plug Washer	\$1.53	94109-12000
				MR049	Oil Pump Gasket	\$6.74	15152-KCY-670
		<b>Oil Seal Kit</b>	<b>List Price</b>	<b>Component Part#</b>	<b>Component Description</b>	<b>List Price</b>	<b>OEM Part #</b>
		C7825OS	\$15.05	OS286	Clutch Pushrod Oil Seal	\$4.29	91204-KK0-003
				OS254	Shift Shaft Seal	\$3.57	91202-965-003
				OS257	Output Shaft Seal	\$3.94	91203-KCY-671
				OS236	Oil Pump Seal	\$4.23	91201-KF0-00391201-HM3-A61
		<b>Clutch &amp; Mag Kit</b>	<b>List Price</b>	<b>Component Part#</b>	<b>Component Description</b>	<b>List Price</b>	<b>OEM Part #</b>
		C7825CM	\$29.74	EC344032AFM	Clutch Cover Gasket	\$14.87	11394-KCY-671
				EC361032AFM	Mag Cover Gasket	\$14.87	11395-KCY-671

## HONDA FOURTRAX

Model	Year	Bore Size	Top End Kit	List Price	Component Part#	Component Description	List Price	OEM Part #
Fourtrax	95-03	88 mm	C7301	\$31.92	H0434043F	Head Gasket	\$24.75	12251-HM7-004
Foreman		95 mm	C7644	\$31.92	H0877043F	95mm Bore Head Gasket	\$28.51	12251-HM7-004
400					B0259020F	Base Gasket	\$6.25	12191-HM7-003
					B041020F	Big Bore Base Gasket	\$12.39	12191-HM7-003
					<b>Component Part#</b>	<b>Description</b>	<b>List Price</b>	<b>OEM Part#</b>
					EC611020F	Clutch Cover Gasket	\$14.87	11394-HM7-003

All Component Parts can be purchased individually.

**WARNING:** Cancer and Reproductive Harm www.P65Warnings.ca.gov



# ATV Gaskets



Cometic Gasket - An Exclusive NASCAR Performance® Product

## HONDA TRX450R

Model	Year	Bore Size	EST	List Price	Component Part#	Component Description	List Price	OEM Part #		
TRX450R	04-05	94 mm	<b>Top End Kit</b>							
			C7877-EST	\$72.75	H2175027S	94mm Bore Head Gasket	\$31.15	12251-HP1-671		
			C7199-EST	\$72.75	H2084027S	95mm Bore Head Gasket	\$31.15	12251-HP1-671		
			C7878-EST	\$72.75	H2084SP1027S	96mm Bore Head Gasket	\$31.15	12251-HP1-671		
			C7201-EST	\$72.75	H2129027S	97mm Bore Head Gasket	\$31.15	12251-HP1-671		
			C3079-EST	\$72.75	H2131SP2027S	100mm Bore Head Gasket	\$31.15	12251-HP1-671		
			C3076-EST	\$72.75	H2131SP1027S	101mm Bore Head Gasket	\$31.15	12251-HP1-671		
					B0741014RC	Base Gasket	\$13.47	12191-HP1-671		
					B0741SP1014RC	Big Bore Base Gasket 99mm and Larger	\$13.47	12191-HP1-671		
					EX657	Exhaust Gasket	\$9.37	4BE-14613-00-00		
					EC979032AFM	Cam Chain Tensioner Gasket	\$3.12	14523-MAL-A00		
					MA0164	Tensioner Bolt Washer	\$0.93	90442-397-000		
					3231V	Valve Seals 4 Req.	\$6.48 ea.	12209-KL4-005		
					R45.5X2.5V	Thermostat Cover O-ring	\$2.34	91373-733-003		
					<b>Bottom End Kit</b>	<b>List Price</b>	<b>Component Part#</b>	<b>Description</b>	<b>List Price</b>	<b>OEM Part#</b>
					C3331	\$54.99	EC982032AFM	Inner Clutch Cover Gasket	\$17.84	11394-HP1-670
							EC981032AFM	Mag Cover Gasket	\$15.44	11395-HP1-670
							EC980020F	Center Case Gasket	\$12.83	11191-HP1-670
							MA0165	Crankcase Oil Drain Washer	\$0.81	90474-333-000
							R10X2V	Breather Joint O-Ring	\$1.59	91304-HA5-003
				R14X2.5V	Timing Mark Sight Plug O-ring	\$1.13	91303-377-000			
				R18X2.5V	Inner Clutch Dowel O-ring	\$1.71	91256-383-721			
				R18X3V	Trans./Engine Oil Fill Plug	\$1.71	91307-035-000			
					O-rings 2 Req.					
				R27X2V	Inner Clutch Plug O-ring	\$1.86	91305-KF0-003			
				R40X2V	Oil Filter Cover O-ring	\$2.82	91302-PA9-003			
				R8.5X2V	Relief Valve O-ring	\$1.10	90751-GK1-003			
				WA128	Crush Washer Case Oil Seal	\$1.59	90463-ML7-000			
TRX450R, ER	06-14	96 mm	<b>Top End Kit</b>							
			C3139-EST	\$80.99	H2458027S	96mm Bore Head Gasket	\$37.39	12251-MEY-671		
			C3141-EST	\$80.99	H2458SP1027S	98mm Bore Head Gasket	\$37.39			
			C3272-EST	\$80.99	H2459027S	99mm Bore Head Gasket	\$37.39			
			C3156-EST	\$80.99	H2460027S	101mm Bore Head Gasket	\$37.39			
					B0856014RC	Base Gasket	\$13.47	12191-HP1-601		
					EX657	Exhaust Gasket	\$9.37	18291-MEB-670		
					EC960018AFM	Cam Chain Tensioner Gasket	\$3.35	14560-MEN-671		
					EC979032AFM	Cam Chain Tensioner Gasket Early	\$3.12	14523-MAL-A00		
					3231V	Exhaust Valve Seals 2 Req.	6.48 ea.	12209-KL4-005		
					3234V	Intake Valve Seals 2 Req.	5.50 ea.	12209-GB4-682		
					MA0164	Cam Chain Tensioner Bolt Seal	\$0.93	90442-397-000		
					R45.5X2.5V	Thermostat Housing Gasket	\$2.34	91373-733-003		
					<b>Bottom End Kit</b>	<b>List Price</b>	<b>Component Part#</b>	<b>Description</b>	<b>List Price</b>	<b>OEM Part#</b>
					C3139BE	\$92.60	WA118	Case Seal Crush Washer 8 Req.	\$1.88	90488-425-000
							EC1134020F	Center Case Gasket	\$12.83	11191-HP1-600
							EC978	Clutch Cover O-ring		11352-HP1-670
							EC1133032AFM	Inner Clutch Cover Gasket	\$17.84	11394-HP1-600
							EC1223032AFM	Mag Cover Gasket	\$16.13	11395-HP1-600
							WA111	Water Pump Crush Washer	\$0.80	90447-KE1-000
				R8X2V	Relief Valve O-ring	\$1.13	90751-GK1-003			
				R18X2.5V	Case Dowel O-ring	\$1.71	91256-383-721			
				R40X2V	Oil Filter O-ring	\$2.82	91302-PA9-003			
				R14X2.5V	Timing Plug O-ring	\$1.13	91303-377-000			
				R27X2V	Right Case Plug O-ring	\$1.86	91305-KF0-003			
				R18X3V	Fill Plug O-rings 2 Req	\$1.71	91307-035-000			
				WA137	Drain Plug Gasket	\$1.53	94109-12000			
				<b>Oil Seal Kit</b>	<b>Description</b>	<b>List Price</b>	<b>OEM Part#</b>			
				C3139OS	\$39.61	OS292	Right Crank Seal	\$10.68	91202-HP1-601	
						OS262	Balancer Shaft Seal	\$2.60	91204-HP1-601	
						OS264	Left Crank Seal	\$10.97	91201-MEB-671	
						OS227	Shift Shaft Seal	\$2.67	91203-KA4-771	
						OS289	Oil Pump Seal	\$4.49	91203-HP1-601	
						OS239	Start Shaft Seal	\$2.60	91204-KF0-003	
						OS240	Clutch Pushrod Seal	\$2.43	91205-MEB-671	
						OS238	Output Shaft Seal	\$3.17	91207-ML3-871	

All Component Parts can be purchased individually.



**WARNING:** Cancer and Reproductive Harm www.P65Warnings.ca.gov



# ATV Gaskets



Cometic Gasket - An Exclusive NASCAR Performance® Product

## HONDA TRX450S/ES

Model	Year	Bore Size	Top End Kit	List Price	Component Part#	Component Description	List Price	OEM Part #
TRX450 S/ES	98-01	92mm	C3689	\$34.99	H2628040S	Head Gasket 92mm bore	\$24.75	12251-HN0-670
TRX450 FM/FE	02-04				B0888020RC	Base Gasket	\$16.64	12191-HM7-013
					C415032AFM	Valve Cover Gasket	\$8.29	12315-HM7-005
					3231V	Valve Stem Seal	\$6.48	12209-KL4-005
					R37X2.4V	Intake O-ring 37x2.4	\$2.75	91305-HN0-A00
					R013V	Valve Guide O-rings 10 x 1.6	\$1.03	91306-105-690
					EC2383018AFM	Chain Tensioner Gasket	\$3.35	14523-HM7-000
					EX651	Header Gasket	\$8.98	18291-MN4-920

## HONDA TRX500FA

Model	Year	Bore Size	Top End Kit	List Price	Component Part#	Component Description	List Price	OEM Part #
TRX500FA Foreman Rubicon	01-14	93mm	C3628	\$87.68	EC036032AFM	Cam Chain Tensioner Gasket	\$1.96	12194-HC5-740
					MA0164	Cam Chain Tensioner	\$0.93	90442-397-000
						Crush Washer		
					3231V	Valve Stem Seal	\$6.48	12209-KL4-005
					R9.5X1.5V	Rocker Arm O-rings	\$2.46	91306-MG3-000
					B0564	Cylinder Base gasket	\$12.99	12191-HN2-000
					R57X2V	Tappet Cover Gasket	\$3.20	91308-500-000
					VC055	Valve Cover Gasket	\$11.87	12315-HN2-003
					H1393	Head Gasket	\$23.45	12251-HN2-003
					EX651	Header Gasket	\$8.98	18291-MN4-920

## TRX680F RINCON



Model	Year	Bore Size	EST Top End Kit	List Price	Component Part#	Component Description	List Price	OEM Part #
TRX680FA	06-17	102 mm	C3475-EST	\$68.71	VC080020RC	Valve Cover Gasket	\$23.80	12315-HN8-000
					R57X2V	Tappet Cover Gasket	\$11.41	91308-500-000
					H1835027S	Cylinder Head Gasket	\$39.36	12251-HN8-A61
					B0665010S	Cylinder Base Gasket	\$15.29	12191-HN8-000
					EX651	Exhaust Gasket	\$8.63	18291-MM5-860
					3231V	Valve Stem Seal	\$6.48	12209-KL4-005
					EC036032AFM	Cam Chain Tensioner	\$1.96	12194-HC5-740
					R9.5X1.5V	Rocker Arm O-rings	\$2.46	91306-MG3-000

## TRX700XX

Model	Year	Bore Size	EST Top End Kit	List Price	Component Part#	Component Description	List Price	OEM Part #
TRX700XX	08-09	102 mm	C3420-EST	\$71.71	H3025SP3027S	Head Gasket 102 mm Bore	\$43.39	12251-HP6-A01
		104 mm	C3286-EST	\$71.71	H3025027S	Head Gasket 104 mm Bore	\$43.39	
					R119B	Water Outlet Oring	\$1.04	91356-169-003
					R5.7X1.9B	Dowel Pin O-ring	\$2.14	91305-323-000
					B1012020RC	Base Gasket	\$9.47	12191-HP6-A01
					EC898018AFM	Cam Chain	\$3.35	14560-KCW-851
					3225V	Valve Seals 4 Req.	\$1.76 ea.	12209-413-003
					EX657	Exhaust Gasket	\$9.37	18291-MEB-670

## KAWASAKI KXT250

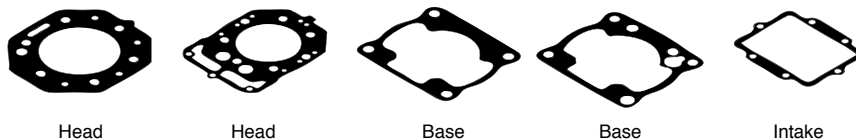

Model	Year	Bore Size	Top End Kit	List Price	Component Part#	Component Description	List Price	OEM Part #
KXT250 Tecate	83-85	72 mm	C7049	\$23.46	H0022043F	Head Gasket 72mm	\$19.82	11004-1057
KXT250 Tecate		76 mm	C7326	\$23.46	H0022SP1043F	Head Gasket 76mm	\$19.82	
					B0025020F	Base Gasket	\$6.25	11009-1318
						Base Gasket		
					H0023043F	Head Gasket 72mm	\$21.76	11004-1144
					H0197043F	Head Gasket 76mm	\$21.76	
					B0026020F	Base Gasket	\$6.25	11009-1546
					IR008018AFM	Intake Gasket	\$3.80	11009-1050
					R136V	Exhaust O-Ring	\$1.19	671E2550

All Component Parts can be purchased individually.



**WARNING:** Cancer and Reproductive Harm [www.P65Warnings.ca.gov](http://www.P65Warnings.ca.gov)





# ATV Gaskets



Cometic Gasket - An Exclusive NASCAR Performance® Product

## KAWASAKI KFX250

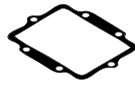

Head

Head

Base

Base

Intake

Model	Year	Bore Size	Top End Kit	List Price	Component Part#	Component Description	List Price	OEM Part #					
KFX250 Mojave	87-05	77 mm	C7244	\$34.60	B0198020F	Base Gasket	\$9.94	11060-1125					
					H0341010C	77mm Head Gasket	\$28.51	11004-1121					
					<b>Component Part#</b>	<b>Component Description</b>	<b>List Price</b>	<b>OEM Part #</b>					
					EC618020F	Clutch Cover Gasket	\$16.13	11060-1238					
					<b>Component Part#</b>	<b>Component Description</b>	<b>List Price</b>	<b>OEM Part #</b>					
KLF250 Bayou	88-06	70 mm	EST Top End Kit C7243-EST	\$63.14	H0261040S	Head Gasket 70mm	\$24.75	11004-1375					
					B0169020F	Base Gasket	\$7.44	11061-1104					
					EX692064AM	Exhaust Gasket	\$2.56	11009-1866					
					R10X2V	Valve Guide O-Ring 2 Req	\$1.59	92055-1177					
					R95X2V	Cam Sprocket Cover O-Ring	\$4.00	671B2595					
					R70X2S	Cylinder O-Ring	\$3.21	92055-1672					
					R32X3V	Intake O-Ring 2 Req	\$3.57	92055-1256					
					R118B	Cam Tensioner O-Ring	\$1.13	670B2021					
					R227V	Rocker Cap O-Ring 2 Req	\$3.92	92055-112					
					3241V	Valve Stem Seals 2 Req	\$3.46	92049-1062					
										<b>Component Part#</b>	<b>Component Description</b>	<b>List Price</b>	<b>OEM Part #</b>
										EC1088032AFM	Clutch Cover Gasket	\$28.57	11060-1648
					KXF250 Tecate 4	87-88	69.5 mm	C7039	\$32.43	H0034043F	Head Gasket 69.5	\$19.82	11004-1157
74 mm	C7323	\$32.43	H0204043F	Head Gasket 74mm			\$19.82						
					B0032020F	Base Gasket	\$6.25	11009-1624					
					IR008018AFM	Intake Gasket	\$3.80	11009-1252					
					PV012020F	Power Valve Gasket	\$3.80	11009-1625					
					R136V	Exhaust O-Ring	\$1.19	671E2525					

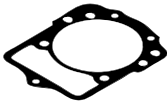

Head

Base

Model	Year	Bore Size	Top End Kit	List Price	Component Part#	Component Description	List Price	OEM Part #		
KLF300	86-87	77 mm	C7245	\$29.59	H0256043F	Head Gasket	\$23.57	11004-1136		
					B0163020F	Base Gasket	\$9.32	11060-1221		
					<b>Component Part#</b>	<b>Component Description</b>	<b>List Price</b>	<b>OEM Part #</b>		
KEF300	97-03	79 mm	C7248	\$32.81	B0163020F	Base Gasket	\$9.32	11060-1652		
Lakota	92-03				H0256020C	Head Gasket 79mm	\$27.14	11004-1183		
KLF300					<b>Component Part#</b>	<b>Component Description</b>	<b>List Price</b>	<b>OEM Part #</b>		
KLF300 Bayou 4x4	89-05				EC598020F	Clutch Cover Gasket 2WD	\$14.65	11060-1655		
					<b>Component Part#</b>	<b>Component Description</b>	<b>List Price</b>	<b>OEM Part #</b>		
KLX 400	03-04	92 mm	C7688-EST	\$64.23	H0949027S	Head Gasket 92mm	\$30.95	11004-S006		
		94 mm	C7806-EST	\$64.23	H1045027S	Head Gasket 94mm	\$30.95			
		95mm	C7963-EST	\$64.23	H1699027S	Head Gasket 95mm	\$30.95			
		97 mm	C7980-EST	\$64.23	H1046027S	Head Gasket 97mm	\$30.95			
							B0440010RC	Base Gasket	\$8.69	11061-S091
							EX243	Exhaust Gasket	\$2.79	11061-S076
							EC377032AFM	Cam Tensioner Gasket	\$3.35	11061-S073
							WA121	Oil Check Washer	\$0.80	11061-S006
					3160V	Valve Stem Seal 4 Req	\$5.50	92049-S006		
					<b>Component Part#</b>	<b>Component Part#</b>	<b>List Price</b>	<b>OEM Part#</b>		
					EC837032AFM	Clutch Cover	\$13.29	92055-S080		
KLF400 Bayou 4x4	93-02	84.5 mm	C7249	\$43.99	H0340010C	Head Gasket	\$35.60	11004-1233		
					B0201020F	Base Gasket	\$9.94	11060-1205		
KVF400	99-02									

All Component Parts can be purchased individually.



**WARNING:** Cancer and Reproductive Harm www.P65Warnings.ca.gov



# ATV Gaskets



Cometic Gasket - An Exclusive NASCAR Performance® Product

## KAWASAKI KFX400



Head

Base

Cam Chain Tensioner

Model	Year	Bore Size	EST Top End Kit	List Price	Component Part#	Component Description	List Price	OEM Part #		
KFX400	03-06	92 mm	C7978-EST	\$64.23	H0949027S	Head Gasket 92mm	\$30.95	11004-S006		
			94 mm	C7979-EST	\$64.23	H1045027S	Head Gasket 94mm		\$30.95	
			96 mm	C3138-EST	\$64.23	H1045SP2027S	Head Gasket 96mm		\$30.95	
			97 mm	C7980-EST	\$64.23	H1046027S	Head Gasket 97mm		\$30.95	
						B0440027S	Base Gasket	\$28.51	11061-S070	
						EX243	Exhaust Gasket	\$2.79	11061-S076	
						EC377032AFM	Cam Tensioner Gasket	\$3.35	11061-S073	
						WA121	Oil Drain Bolt Gasket	\$0.80	11061-S005	
						3160V	Valve Stem Seals 4 Req	\$5.50	92049-S006	
					<b>Clutch &amp; Mag Kit</b>	<b>List Price</b>	<b>Component Part#</b>	<b>Component Description</b>	<b>List Price</b>	<b>OEM Part #</b>
					C7978CM	\$33.41	EC1030032AFM	Clutch Cover Gasket	\$20.22	11061-S071
							EC1034032AFM	Mag Cover Gasket	\$12.99	11061-S072
							<b>Component Part#</b>	<b>Component Part#</b>	<b>List Price</b>	<b>OEM Part#</b>
					EC1030032AFM	Clutch Cover Gasket	\$20.22	11061-S071		
					EC1034032AFM	Mag Cover Gasket	\$12.99	11061-S072		
KFX450R	08-14	96 mm	C3201-EST	\$69.14	H2466027S	Head Gasket 96.5mm	\$43.54	11004-0073		
			98 mm	C3202-EST	\$69.14	H2466SP1027S	Head Gasket 98mm		\$43.54	
						B0911020RC	Base Gasket	\$11.81	11061-0234	
						EC1080032AFM	Cam Tensioner Gasket	\$2.33	11061-0260	
						R013V	Water Temp O-Ring	\$1.19	92055-0016	
						R022V	Spark Plug O-Ring	\$1.19	92055-0046	
						R10X2V	Cam Chain Tensioner O-Ring	\$1.59	670D2010	
						3241V	Valve Stem Seals 4 Req	\$3.46	92049-1062	
					<b>Bottom End Kit w/Oil Seals</b>	<b>List Price</b>	<b>Component Part#</b>	<b>Component Description</b>	<b>List Price</b>	<b>OEM Part #</b>
					C3201BE	\$102.16	R011B	Case Oil Feed O-ring	\$1.13	670D1508
							WA108	Drain Plug Seal	\$2.56	92065-097
							R20X2V	Clutch Fill Plug O-ring	\$3.02	92055-1146
							R141SB	Oil Pump Cover O-ring	\$18.99	92055-0110
					R015V	Timing Plug O-ring	\$1.13	92055-1141		
					R123V	Crank Plug O-ring	\$1.19	92055-091		
					R138SB	Oil Filter O-rings (2)	\$5.71	92055-1577		
					R008B	Oil Line O-rings (3)	\$0.11	670D1505		
					EC1185032AFM	Inner Clutch Cover Gasket	\$28.57	11061-0236		
					R010B	Oil Pipe O-rings (2)	\$0.62	670D1507		
					R214B	Starter Motor O-ring	\$0.51	92055-1276		
					WP209018AFM	Water Pump Cover	\$4.72	11061-0237		
					WA118	Water Pump Bolt Seal	\$1.88	92022-304		
			<b>Oil Seal Kit</b>	<b>List Price</b>	<b>Component Part#</b>	<b>Component Description</b>	<b>List Price</b>	<b>OEM Part #</b>		
			C3201OS	\$24.36	OS331	Shift Shaft Seal	\$3.71	92051-005		
					OS339	Clutch Shaft Seal	\$2.59	92049-1475		
					OS295	Out Put Shaft Seal 30x40x7	\$9.89	92049-0030		
					OS277	Oil Pump Seal 12x24x7	\$1.48	92049-0040		
					OS227	Water Pump Seal 12x22x5	\$2.67	92049-0041		
					OS275	Clutch Pushrod Seal 10x20x5	\$4.02	92049-1542		
			<b>Clutch &amp; Mag Kit</b>	<b>List Price</b>	<b>Component Part#</b>	<b>Component Description</b>	<b>List Price</b>	<b>OEM Part #</b>		
			C3201CM	\$38.72	EC1184032AFM	Clutch Cover	\$11.87	11061-0259		
					EC1183032AF	Mag Cover Gasket	\$26.65	11061-0235		

All Component Parts can be purchased individually.



**WARNING:** Cancer and Reproductive Harm [www.P65Warnings.ca.gov](http://www.P65Warnings.ca.gov)



# ATV Gaskets



Cometic Gasket - An Exclusive NASCAR Performance® Product

## KAWASAKI KV650

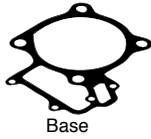
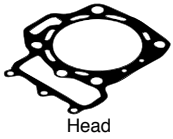

Model	Year	Bore Size	EST Top End Kit	List Price	Component Part#	Component Description	List Price	OEM Part #
KVF650	01-03	81 mm	C7981-EST	\$101.70	H1893010S	Head Gasket 81mm 2 Req	\$24.75	11004-1373
Prairie 4x4		83 mm	C7982-EST	\$101.70	H1894010S	Head Gasket 83mm 2 Req	\$24.75	11004-1373
KFX700	04-07	84 mm	C3125-EST	\$101.70	H1894SP7010S	Head Gasket 84mm 2 Req	\$24.75	11004-1373
V Force		85 mm	C7173-EST	\$101.70	H1983010S	Head Gasket 85mm 2 Req	\$24.75	11004-1384
KVF700	04-07	87 mm	C3163-EST	\$101.70	H2513SP1010S	Head Gasket 87mm 2 Req	\$24.75	
Prairie		89 mm	C3162-EST	\$101.70	H2513010S	Head Gasket 89mm 2 Req	\$24.75	
		90mm	C3212-EST	\$101.70	H2513SP3010S	Head Gasket 90mm 2 Req	\$24.75	
					B0677020RC	Base Gasket 2 Req	\$9.94	11060-1965
					EX361	Exhaust Gasket 2 Req	\$5.50	11009-1894
					R129B	Intake O-Rings 2 Req	\$1.13	92055-1295
					R140V	Rocker Cap O-Ring 4 Req	\$3.29	92055-1644
					R14X2.5V	Oil Cap O-Ring	\$1.13	670D2014
					R16X2V	Water Pipe O-Ring 2 Req	\$3.02	670B2016
					3242V	Valve Stem Seals 8 Req	\$3.02	92049-1218
			<b>EST Top End Kit</b>	<b>List Price</b>	<b>Component Part#</b>	<b>Component Description</b>	<b>List Price</b>	<b>OEM Part #</b>
KVF750	08-16	85mm	C3284-EST	\$122.60	H2624SPA010S	Head Gasket 85mm	\$28.29	11004-0011
Brute Force		90 mm	C3251-EST	\$122.60	H2624SP1010S	Head Gasket 90mm	\$28.29	11004-0011
					B0951020RC	Base Gasket	\$9.94	11061-0063
					EX361	Exhaust Gasket 2 req	\$5.50	11009-1894
					WA114	Coolant Drain Washer 2 Req	\$3.02	
					R55X2V	Rocker Cap O-Ring 4 Req	\$2.34	92055-0112
					R19X2V	Plug Cover O-Ring 2 Req	\$2.50	92055-1146
					3242V	Valve Stem Seals 8 Req	\$3.02	92049-1218

## KTM 450SX

Model	Year	Bore Size	EST Top End Kit	List Price	Component Part#	Component Description	List Price	OEM Part #
450 SX ATV	07-10	97mm	C3412-EST	\$57.69	H2623027S	Head Gasket 97mm Bore	\$29.11	77330036000
					R010V	Oil Jet O-rings	\$0.40	0770060015
					R9X1.5V	Head Oil Plug O-ring	\$2.56	0770090015
					EX873059F	Exhaust Gasket	\$5.05	77336041000
					R014V	Head Coolant Plug Gasket	\$1.08	0770090015
					R25X2V	Cam Tower Plug Well O-ring	\$3.21	0770025020
					3225V	Valve Stem Seals	\$1.76 ea.	59036027000
					R013B	Cam Chain Tensioner O-ring	\$1.19	0770010010
					WA145	Cam Chain Tens. Crush Seal	\$2.16	0603242920
					R18X2.5V	Cam Chain Tens. Piston O-ring	\$1.71	0770180020
					R014V	Cam Chain Bushing O-ring	\$1.08	0770012015
					R017B	Cam Axle O-ring	\$1.14	0770015018
					R046V	Base O-ring	\$1.19	0770108018
					B0928	Cam Galley Base O-ring	\$4.75	77330035000
			<b>EST Top End Kit</b>	<b>List Price</b>	<b>Component Part#</b>	<b>Component Description</b>	<b>List Price</b>	<b>OEM Part #</b>
505 SX ATV	07-10	100mm	C3413-EST	\$57.69	H2623SP1027S	Head Gasket 100mm Bore	\$29.11	77330036000
					R010V	Oil Jet O-rings	\$0.40	0770060015
					R9X1.5V	Head Oil Plug O-ring	\$2.56	0770090015
					EX873059F	Exhaust Gasket	\$5.05	77336041000
					R014V	Head Coolant Plug Gasket	\$1.08	0770090015
					R25X2V	Cam Tower Plug Well O-ring	\$3.21	0770025020
					3225V	Valve Stem Seals	\$1.76 ea.	59036027000
					R013B	Cam Chain Tens. O-ring	\$1.19	0770010010
					WA145	Cam Chain Tens. Crush Seal	\$2.16	0603242920
					R18X2.5V	Cam Chain Tens. Piston O-ring	\$1.71	0770180020
					R014V	Cam Chain Bushing O-ring	\$1.08	0770012015
					R017B	Cam Axle O-ring	\$1.14	0770015018
					R046V	Base O-ring	\$1.19	0770108018
					B0928	Cam Galley Base O-ring	\$4.75	77330035000

**All Component Parts can be purchased individually.**



**WARNING:** Cancer and Reproductive Harm [www.P65Warnings.ca.gov](http://www.P65Warnings.ca.gov)





# ATV Gaskets



Cometic Gasket - An Exclusive NASCAR Performance® Product

## KTM 450 XC

Model	Year	Bore Size	EST Top End Kit	List Price	Component Part#	Component Description	List Price	OEM Part #		
450 XC ATV	08-10	89 mm	C3263-EST	\$68.99	H1017SP2040S	Head Gasket 89mm Bore	\$41.55	59530036000		
		91mm	C3264-EST	\$68.99	H1017040S	Head Gasket 91mm Bore	\$41.55			
					B0480020RC	Base Gasket	\$9.94	59030035050		
					3225V	Valve Seals 4 Req.	\$1.76 ea.	59036027000		
					EC495018AFM	Cam Chain Tensioner Gasket	\$3.80	59036003050		
					EX281042AM	Exhaust Gasket	\$12.44	59036041000		
					R019V	Rocker Arm O-ring	\$0.57	770191016		
					R40X2.5B	Oil Filter O-rings 2 Req.	\$3.74	770400025		
					VC027031F	Valve Cover Gasket 2 Req.	\$1.19	58036053000		
					WA005063C	Crush Washers 4 Req.	\$0.57	603061001		
					WP114018AFM	Water Pump Gasket	\$1.71	59035053000		
			<b>EST Top End Kit</b>	<b>List Price</b>	<b>Component Part#</b>	<b>Component Description</b>	<b>List Price</b>	<b>OEM Part #</b>		
525 XC ATV	08-10	95 mm	C7944-EST	\$71.71	H1521040S	Head Gasket 95mm Bore	\$41.55	5813169		
		96 mm	C7454-EST	\$71.71	H2081040S	Head Gasket 96mm Bore	\$41.55			
		97 mm	C7691-EST	\$71.71	H1018040S	Head Gasket 97mm Bore	\$41.55			
		98 mm	C7461-EST	\$71.71	H1018SP4040S	Head Gasket 98mm Bore	\$41.55			
		99 mm	C7792-EST	\$71.71	H1018SP2040S	Head Gasket 99mm Bore	\$41.55			
						B0480020RC	Base Gasket	\$9.94	59030035050	
						EC495018AFM	Timing Chain Tens. Gasket	\$3.80	59036003050	
						EX281042AM	Exhaust Gasket	\$12.44	59036041000	
						R017B	2 Req.-Oil Screen Plug O-ring	\$1.14	5413248	
						R12.5X2V	2 Req.-Oil Screen Plug O-ring	\$3.74	5413249	
						R40X2.5B	2 Req.-Oil Filter O-ring	\$3.74	5413254	
						VC027031F	Valve Cover Gasket 2 Req.	\$1.19	59530036000	
						WA005063C	Crush Washers 4 Req.	\$0.57	603061001	
					<b>Bottom End Kit w/o crank seals C3340</b>	<b>List Price</b>	<b>Component Part#</b>	<b>Component Part#</b>	<b>List Price</b>	<b>OEM Part#</b>
						\$55.61	WP114018AFM	Water Pump Gasket	\$1.71	59035053000
					EC1377020F	Ignition Cover Gasket	\$17.38	5813170		
					EC494032AFM	Mag. Cover Gasket	\$17.38	5813174		
					EC496032AFM	Clutch Cover Gasket	\$17.38	5413309		
					EC497012F	Center Case Gasket	\$17.38	59030039000		

## POLARIS PREDATOR 90

Model	Year	Bore Size	Top End Kit	List Price	Component Part#	Component Description	List Price	OEM Part #
Predator 90	01-06	53mm	C3514	\$15.99	H2381SP1043F	Head Gasket	\$7.21	0450004
					B0774020F	Base Gasket	\$5.05	0450009
					EX650064AM	Exhaust Gasket	\$4.20	0450122

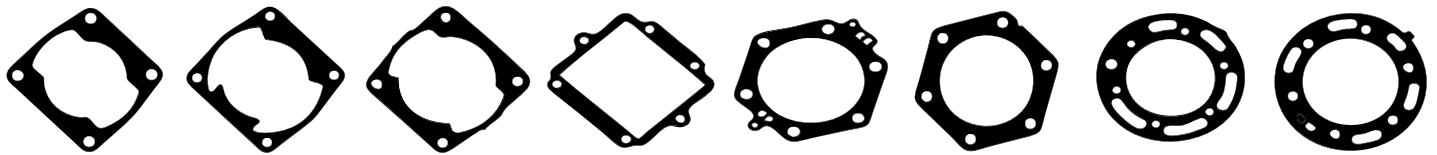

Model	Year	Bore Size	Top End Kit	List Price	Component Part#	Component Description	List Price	OEM Part #
Big Boss 4x6	89-92	72 mm	C7124	\$21.76	H0018043F	Head Gasket 72mm	\$19.82	3084015
		73.5 mm	C3485	\$21.76	H0018SP4040S	Head Gasket 73.5mm .040" Steel	\$19.82	3084015
Big Boss 6x6	91-93				B0070018AFM	Base Gasket	\$6.25	3083733/3084016
Cyclone Trail Blazer	87 90-06				EX015042AM	Exhaust Gasket	\$3.48	3084026/3084439
Trail Boss 2x4	85-96 87-93							
Trail Boss 4x4	88-93							

All Component Parts can be purchased individually.

**WARNING:** Cancer and Reproductive Harm www.P65Warnings.ca.gov



# ATV Gaskets



Cometic Gasket - An Exclusive NASCAR Performance® Product

## POLARIS 2x4 300

Model	Year	Bore Size	Top End Kit	List Price	Component Part#	Component Description	List Price	OEM Part #
2x4 300	94-95	78 mm	C7310	\$21.76	H0451020S	Head Gasket	\$13.62	3085098
4x4 300	94-95				B0265018AFM	Base Gasket	\$6.25	3084795
6x6 300	94-94				EX015042AM	Exhaust Gasket	\$3.48	3084026/3084439
Xplorer 96-00 300								
Xpress 96-00 300								
Sportsman 4x4	93-93	82 mm	C7144	\$25.55	H0212059F	Head Gasket	\$22.32	3084517
Trail Boss 2x4 350L	90-93				B0151020F	Base Gasket	\$7.16	3084140
Trail Boss 4x4 350L	90-93				EX015042AM	Exhaust Gasket	\$3.48	3084026/3084439
Trail Boss 6x6 350L					IR044018AFM	Intake Gasket	\$3.80	3084148
2x4 400L	94-95	85 mm	C7265	\$31.91	H0345010S	Head Gasket	\$19.82	308415
4x4 400L	94				B0206018AFM	Base Gasket	\$7.16	3084729
6x6 400L	94-03				EX015042AM	Exhaust Gasket	\$3.48	3084026/3084439
Sportsman 4x4					IR044018AFM	Intake Gasket	\$3.80	3084148
Scrambler 4x4	95-00							
Sport 400L	96-00							
Trail Blazer ES								
Xplorer 400L 4x4	95-00							
Xpress 400	96-00							
Magnum 2x4	95-00	92 mm	C7311	\$49.80	H0452059F	Head Gasket	\$34.75	3085337
Magnum 4x4	95-00				B0266020F	Base Gasket	\$7.16	3084851
Magnum 6x6	96				EX038042AM	Exhaust Gasket	\$4.26	3083575/3083023
					R015V	O-ring	\$1.13	3084867
Scrambler 500	97-03	94 mm	C7312	\$49.80	H0453059F	Head Gasket	\$34.75	3084865
Scrambler, 97-05					B0267020F	Base Gasket	\$7.16	3084851
Sportsman 500					EX038042AM	Exhaust Gasket	\$4.26	3083575/3083023
Xplorer 500 1997								
Sportsman 550	09-14	98mm	C3610	\$73.98	H4312027S	Head Gasket 98mm Bore	\$29.65	3090104
		101mm	C3611	\$73.98	H4312SP1027S	Head Gasket 101mm Bore	\$29.65	
					WA165063A	Head Plug Gasket	\$0.99	3084861
					WA118	Head Oil Drain Plug Gasket	\$0.99	3088030
					B1362010RC	Base Gasket	\$14.99	3090092
					IR1384	Intake Gasket	\$1.19	3090144
					EX657	Exhaust Gasket	\$13.50	3090004
					3264V	Valve Seal	\$1.62	3090098
					WA117	Oil Line Crush Washers	\$1.19	3088044
					EC2226	Cam Chain Tensioner Gasket	\$2.49	3086448
					R030V	Cam Cover O-ring	\$2.49	3090131



# ATV Gaskets



Cometic Gasket - An Exclusive NASCAR Performance® Product

## POLARIS PREDATOR 500

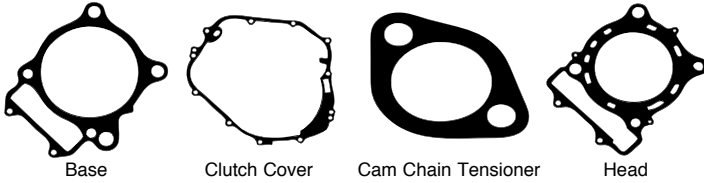

Model	Year	Bore Size	Top End Kit	List Price	Component Part#	Component Description	List Price	OEM Part #
Predator 500	03-07	99 mm	C7971-EST	\$85.80	H1818SP1027S	Head Gasket 99mm Bore	\$40.93	3087948
		100 mm	C7995-EST	\$85.80	H1818030S	Head Gasket 100mm Bore	\$40.93	
Outlaw 500	06-07	103 mm	C7972-EST	\$85.80	H1818SP4030S	Head Gasket 103mm Bore	\$40.93	
		105 mm	C3160-EST	\$85.80	H1819030S	Head Gasket 105.5mm Bore	\$40.93	
					B0658010RC	Base Gasket	\$9.32	3089519
					EC996032AFM	Cam Chain Tensioner	\$2.33	3088022
					EX634	Exhaust Gasket/2 Req.	\$8.91	3087957
					WA117	6 Req.-Oil Filter Copper Washer	\$0.95	3088044
					3243V	4 Req. Valve Stem Seals	\$1.53	3084908
					VC120	Valve Cover Gasket	\$24.99	3089441
			<b>EST Top End Kit</b>	<b>List Price</b>	<b>Component Part#</b>	<b>Component Description</b>	<b>List Price</b>	<b>OEM Part #</b>
XP1000	14-19	94mm	C3546-EST	\$85.66	H3892018S	Cyl. Head Gasket 94mm Bore	\$34.27	5813737
		96mm	C3563-EST	\$85.66	H3892SP1018S	Cyl. Head Gasket 96mm Bore	\$34.27	5813737
					B1079014RC	Base Gasket	\$19.29	5253037
					EC1654020RC	Cam Chain Tensioner Gasket	\$3.52	5813449

## OUTLAW (KTM Motor)

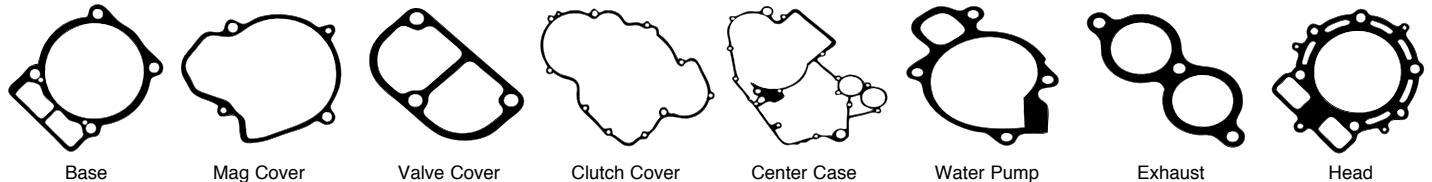

Model	Year	Bore Size	EST Top End Kit	List Price	Component Part#	Component Description	List Price	OEM Part #
Outlaw 525	06-11 (KTM motor)	95 mm	C7944-EST	\$71.71	H1521040S	Head Gasket 95mm Bore	\$41.55	5813169
		96 mm	C7454-EST	\$71.71	H2081040S	Head Gasket 96mm Bore	\$41.55	
		97 mm	C7691-EST	\$71.71	H1018040S	Head Gasket 97mm Bore	\$41.55	
		98 mm	C7461-EST	\$71.71	H1018SP4040S	Head Gasket 98mm Bore	\$41.55	
		99 mm	C7792-EST	\$71.71	H1018SP2040S	Head Gasket 99mm Bore	\$41.55	
					B0480020F	Base Gasket	\$4.32	5813172
					EC495018AFM	Timing Chain Tens. Gasket	\$3.80	5813173
					EX281042AM	Exhaust Gasket	\$12.44	5813168
					R017B	2 Req.-Oil Screen Plug O-ring	\$1.14	5413248
					R12.5X2V	2 Req.-Oil Screen Plug O-ring	\$3.74	5413249
					R40X2.5B	2 Req.-Oil Filter O-ring	\$3.74	5413254
					VC027031F	2 Req.-Valve Cover Gasket	\$1.19	5813175
					WA005063C	4 Req.-Copper Washer	\$0.57	25437-86
			<b>Bottom End Kit w/o crank seals</b>	<b>List Price</b>	<b>Component Part#</b>	<b>Component Description</b>	<b>List Price</b>	<b>OEM Part#</b>
			C3394	\$43.63	WP114018AFM	Water Pump Gasket	\$1.71	5813172
					EC1377020F	Ignition Cover Gasket	\$17.38	5813170
					EC494032AFM	Mag. Cover Gasket	\$17.38	5813174
					EC496032AFM	Clutch Cover Gasket	\$17.38	5413309
					EC497012F	Center Case Gasket	\$17.38	59030039000

All Component Parts can be purchased individually.

**WARNING:** Cancer and Reproductive Harm [www.P65Warnings.ca.gov](http://www.P65Warnings.ca.gov)





# ATV Gaskets



Cometic Gasket - An Exclusive NASCAR Performance® Product

## SUZUKI LT50

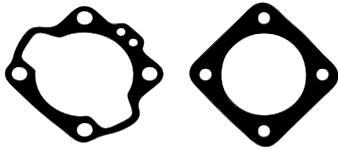

Model	Year	Bore Size	Top End Kit	List Price	Component Part#	Component Description	List Price	OEM Part #
LT50	84-87	43 mm	C7262	\$16.06	H0263010C	Head Gasket	\$14.20	11141-04000
					B0161020F	Base Gasket	\$4.37	11241-04010

## SUZUKI LT80

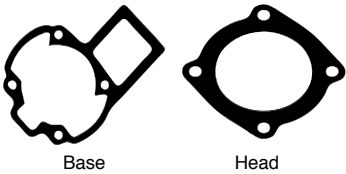

Model	Year	Bore Size	Top End Kit	List Price	Component Part#	Component Description	List Price	OEM Part #
LT80	87-06	52 mm	C7259	\$30.84	H0314020C	Head Gasket 52mm bore	\$17.15	H11141-07910
		54 mm	C7709	\$30.84	H0899020C	Head Gasket 54mm Bore	\$17.15	
		55 mm	C7931	\$30.84	H0314SP4020C	Head Gasket 55mm Bore	\$17.15	
LT230	85-93	67 mm 71 mm	Top End Kit	List Price	Component Part#	Component Description	List Price	OEM Part #
			C7074	\$33.79	H0056SP1043F	67mm Bore Head Gasket	\$19.82	11141-18A00
			C7329	\$33.79	H0425043C	71mm Bore Head Gasket	\$24.98	
LT250R	85-86	72 mm	Top End Kit	List Price	Component Part#	Component Description	List Price	OEM Part #
			C7070	\$34.47	H0051043F	Head Gasket	\$19.82	11141-13A60
					B0053020F	Base Gasket	\$6.25	11482-19A00-H17
			Bottom End Kit w/crank seals	List Price	Component Part#	Component Description	List Price	OEM Part#
			C3363	\$29.48	C7719	Clutch Cover Gasket	\$15.28	11483-13A00
			Crank Seal Kit	List Price	Component Part#	Component Description	List Price	OEM Part#
			C7676	\$16.99	OS147	35X52X8 Left Crank Seal	\$12.99	09289-36003
					OS148	24X38X7 Right Crank Seal	\$5.91	09283-25078
LT250R	87-92	69 mm 74 mm	Top End Kit	List Price	Component Part#	Component Description	List Price	OEM Part #
			C7071	\$38.33	H0268043F	Head Gasket	\$21.76	11141-01C01-H17
			C7422	\$38.33	H2230043F	Head Gasket 74mm Bore	\$21.76	
			Bottom End Kit w/crank seals	List Price	Component Part#	Component Description	List Price	OEM Part#
			C3364	\$37.39	B0047020F	Base Gasket	\$6.25	11241-01C10
					IR011018AFM	Intake Gasket	\$3.48	3008-076/13156-01C10
					IR176020F	Intake Gasket	\$3.80	13156-01C10
					PV022018AFM	Right Side Power Valve Gasket	\$3.80	11233-00B00-H17
			Bottom End Kit w/crank seals	List Price	Component Part#	Component Description	List Price	OEM Part#
			C3364	\$37.39	C7720	Clutch Cover Gasket	\$15.28	11482-01C10
					EC323020F	Mag Cover Gasket	\$8.29	11483-01C10
					WP074020F	Water Pump Gasket	\$4.15	17431-14303
			Crank Seal Kit	List Price	Component Part#	Component Description	List Price	OEM Part#
			C7675	\$16.85	OS145	35X52X8 Left Side Crank Seal	\$9.47	09283-36004
					OS146	24X38X7 Right Side Crank Seal	\$9.26	09283-25082
LT-F250	88-13	69 mm	Top End Kit	List Price	Component Part#	Component Description	List Price	OEM Part #
			C7260	\$38.33	H0364043F	Head Gasket	\$30.95	11141-19B00
LT-4WDX	87-96	71 mm	C7261	\$38.33	H0363043F	Head Gasket 71mm Bore	\$30.95	
King Quad 4 WD	91-00	70.5 mm	C7314	\$38.33	B0055020F	Base Gasket LT250F 87-97	\$5.34	11241-38300
						LT-FWDX 87-99		
					B0213020F	Base Gasket LT250S 89-90	\$6.25	11241-25C10
					B0214020F	Base Gasket LTF4WDX 87-99	\$6.25	11241-18A20
						King Quad 99-00		

All Component Parts can be purchased individually.



**WARNING:** Cancer and Reproductive Harm www.P65Warnings.ca.gov



# ATV Gaskets



Cometic Gasket - An Exclusive NASCAR Performance® Product

## SUZUKI LT-Z400

Model	Year	Bore Size	EST Top End Kit	List Price	Component Part#	Component Description	List Price	OEM Part #
LT-Z400	03-13	92 mm	C7978-EST	\$64.23	H0949027S	Head Gasket 92mm Bore	\$30.95	11141-29F01
DR-Z400SM All		94 mm	C7979-EST	\$64.23	H1045027S	Head Gasket 94mm Bore	\$30.95	
		97 mm	C7980-EST	\$64.23	H1046027S	Head Gasket 97mm Bore	\$30.95	
					B0440027S	Base Gasket	\$28.51	11241-29F11
					EX243	Exhaust Gasket 2 Req.	\$2.79	14181-29E02
					EC377032AFM	Cam Chain Tensioner Gasket	\$3.35	12837-24A10
					3160V	Valve Seals 4 Req.	\$5.50	09289-05011
					WA121	Cam Chain Tensioner Washer	\$0.80	09168-06023
						<b>Component Part#</b>	<b>List Price</b>	<b>OEM Part#</b>
					EC1030032AFM	Clutch Cover	\$20.22	11482-07G00
					EC1034032AFM	Mag Cover Gasket	\$12.99	11061-S072

## SUZUKI LT-Z450

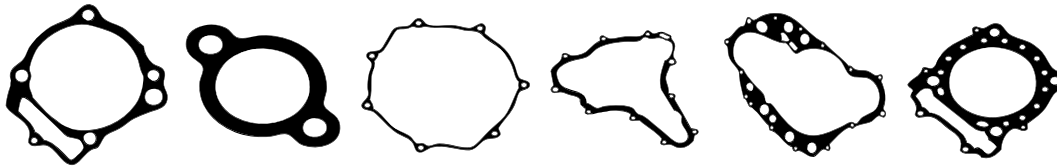

Base      Timing Chain Tensioner      Outer Clutch Cover      Mag Cover      Inner Clutch Cover      Head

Model	Year	Bore Size	EST Top End Kit	List Price	Component Part#	Component Description	List Price	OEM Part #
LT-R450	06-09	96mm	C3208-EST	\$54.99	H2499SP5027S	Head Gasket	\$31.15	11141-45G00
		97mm	C3150-EST	\$54.99	H2499027S	Head Gasket 97mm Bore	\$31.15	
		98mm	C3157-EST	\$54.99	H2499SP2027S	Head Gasket 98mm Bore	\$31.15	
		101mm	C3158-EST	\$54.99	H2499SP1027S	Head Gasket 101mm Bore	\$31.15	
					B0857010RC	Base Gasket	\$11.87	11241-45G00
					EX877	Exhaust Gasket	\$7.56	14181-35G00
					EC377032AFM	Cam Chain Tensioner Gasket	\$3.35	12837-24A10
					3238V	Valve Seals 4 Req.	1.36 ea.	09289-05015
			<b>Bottom End Kit w/o crank seals</b>	<b>List Price</b>	<b>Component Part#</b>	<b>Component Description</b>	<b>List Price</b>	<b>OEM #</b>
			C3378	\$71.32	EC1119018AFM	Clutch Cover	\$11.87	11484-45G00
					EC1120032AFM	Mag Cover Gasket	\$17.84	11483-45G00
					EC1121032AFM	Inner Clutch Cover Gasket	\$28.57	11482-45G00
					R138SB	Oil Filter O-ring	\$5.71	0928-54001
					R32X3V	Crank End O-ring	\$3.57	09280-33004
			<b>Clutch &amp; Mag Kit</b>	<b>List Price</b>	<b>Component Part#</b>	<b>Component Description</b>	<b>List Price</b>	<b>OEM Part #</b>
			C3408CM	\$29.71	EC1119018AFM	Clutch Cover	\$11.87	11484-45G00
					EC1120032AFM	Mag Cover Gasket	\$17.84	11483-45G00

## SUZUKI LT-500H



Base      Left Engine Cover      Head      Intake      Intake      Power Valve

Model	Year	Bore Size	Top End Kit	List Price	Component Part#	Component Description	List Price	OEM Part #
LT500 H	87	88 mm	C7072	\$33.35	H0052043F	88mm Bore Head Gasket	\$22.32	11141-43B01
		89.5 mm	C7273	\$33.35	H0315043F	89.5mm Bore Head Gasket	\$22.32	
		91 mm	C7125	\$33.35	H0054043F	91mm Bore Head Gasket	\$22.32	
					B0054020F	Base Gasket	\$7.16	11241-43B00
					IR176020F	Intake Gasket 87 Model Only	\$3.80	
					PV022018AFM	Right Side Power Valve Cover	\$3.80	11233-00B00-H17
			<b>Bottom End Kit w/crank seals</b>	<b>List Price</b>	<b>Component Part#</b>	<b>Component Description</b>	<b>List Price</b>	<b>OEM #</b>
			C3380	\$36.26	C7718	Clutch Cover Gasket	\$11.47	11482-43B00
					EC321020F	Mag Cover Gasket	\$8.29	11483-43B00
			<b>Crank Seal Kit</b>	<b>List Price</b>	<b>Component Part#</b>	<b>Component Description</b>	<b>List Price</b>	<b>OEM #</b>
			C7677	\$23.50	OS131	24X37X6 Left Crank Oil Seal	\$7.10	09283-25099
					OS133	37X52X8 Right Crank Oil Seal	\$15.44	09283-38021

All Component Parts can be purchased individually.

**WARNING:** Cancer and Reproductive Harm www.P65Warnings.ca.gov



# ATV Gaskets



Cometic Gasket - An Exclusive NASCAR Performance® Product

## SUZUKI LT500

Model	Year	Bore Size	Top End Kit	List Price	Component Part#	Component Description	List Price	OEM Part #	
LT500	88-90	88 mm	C7073	\$33.35	H0053043F	88mm Bore Head Gasket	\$22.32	11111-43B10	
		89.5 mm	C7274	\$33.35	H0316043F	89.5mm Bore Head Gasket	\$22.32		
		91 mm	C7122	\$33.35	H0055043F	91mm Bore Head Gasket	\$22.32		
					B0054020F	Base Gasket	\$7.16	11241-43B10	
					IR011018AFM	Intake Gasket	\$3.48	3008-076/13156-01C10	
					PV022018AFM	Right Side Power Valve Cover	\$3.80	11233-00B00-H17	
				<b>Bottom End Kit w/crank seals</b>	<b>List Price</b>	<b>Component Part#</b>	<b>Component Part#</b>	<b>List Price</b>	<b>OEM #</b>
				C3380	\$36.26	C7718	Clutch Cover Gasket	\$11.47	11482-43B00
						EC321020F	Mag Cover Gasket	\$8.29	11483-43B00
				<b>Crank Seal Kit</b>	<b>List Price</b>	<b>Component Part#</b>	<b>Component Part#</b>	<b>List Price</b>	<b>OEM Part#</b>
			C7675	\$16.85	OS145	35X52X8 Left Side Crank Seal	\$9.47	09283-36004	
					OS146	24X38X7 Right Side Crank Seal	\$9.26	09283-25082	
			<b>Crank Seal Kit</b>	<b>List Price</b>	<b>Component Part#</b>	<b>Component Part#</b>	<b>List Price</b>	<b>OEM Part#</b>	
			C7677	\$20.29	OS131	24X37X6 Left Crank Oil Seal	\$7.10	09283-25099	
					OS133	37X52X8 Right Crank Oil Seal	\$15.44	09283-38021	
LTZ-A700 KingQuad	05-07	106mm	<b>Top End Kit</b>	<b>List Price</b>	<b>Component Part#</b>	<b>Component Description</b>	<b>List Price</b>	<b>OEM Part #</b>	
			C3128-EST	\$42.36	H2424027S	Head Gasket	\$24.99	11141-31G00	
					B0821010RC	Base Gasket	\$9.88	11241-31G00	
					EC1044018AFM	Cam Chain Tensioner Gasket	\$1.81	12837-19B10	
					3238V	Valve Seals 4 Req.	\$1.36 ea.	09289-05015	
					R12.5X2.5V	Thermostat O-ring/Water Line O-ring 2 Req.	\$4.09	09168-12017	
					R7X2V	Cam Chain Tensioner O-ring	\$2.16	09168-26001	

## YAMAHA YFM RAPTOR

Model	Year	Bore Size	Top End Kit	List Price	Component Part#	Component Description	List Price	OEM Part #		
YFM80 RAPTOR	ALL	48mm	C3457	\$19.99	H1905043F	48mm Head Gasket	\$11.41	55X-11181-00-00		
					B0721020F	Base Gasket	\$6.25	22F-11351-01-00		
					EX781	Exhaust Gasket	\$3.35	3DM-14613-00-00		
YT125	80-83	58 mm	<b>Top End Kit</b>	<b>List Price</b>	<b>Component Part#</b>	<b>Component Description</b>	<b>List Price</b>	<b>OEM Part #</b>		
			C7127	\$21.76	H0068043F	Head Gasket	\$17.38	3X3-11181-01-00		
					B0069020F	Base Gasket	\$5.34	18G-11351-01-00		
YT175	82-84	68 mm	<b>Top End Kit</b>	<b>List Price</b>	<b>Component Part#</b>	<b>Component Description</b>	<b>List Price</b>	<b>OEM Part #</b>		
			C7128	\$21.76	H0069043F	Head Gasket	\$19.82	5V7-11181-00-00		
					B0069020F	Base Gasket	\$5.34	18G-11351-01-00		
YTM200	83-85	71 mm	<b>Top End Kit</b>	<b>List Price</b>	<b>Component Part#</b>	<b>Component Description</b>	<b>List Price</b>	<b>OEM Part #</b>		
			C7129	\$34.53	H0066043F	Head Gasket	\$19.82	1NU-11181-00-00		
					B0067020F	Base Gasket	\$5.34	4BD-11351-00-00		
YFM200	85-89	71 mm	<b>Top End Kit</b>	<b>List Price</b>	<b>Component Part#</b>	<b>Component Description</b>	<b>List Price</b>	<b>OEM Part #</b>		
			C7095	\$29.35	H0066043F	Head Gasket	\$19.82	1NU-11181-00-00		
					B0067020F	Base Gasket	\$5.34	4BD-11351-00-00		
YFS200 Blaster	88-06	68 mm	<b>EST Top End Kit</b>	<b>List Price</b>	<b>Component Part#</b>	<b>Component Description</b>	<b>List Price</b>	<b>OEM Part #</b>		
			C7093-EST	\$41.68	H2532SP1030S	Head Gasket 68mm Steel	\$27.26	2XJ-11181-00-00		
			C7332-EST	\$41.68	H2532030S	Head Gasket 72.5mm Steel	\$27.26	2XJ-11181-00-00		
					H0064032C	Head Gasket 68mm Copper	\$24.98	2XJ-11181-00-00		
					H0386032C	Head Gasket 72.5mm Copper	\$24.98	2XJ-11181-00-00		
						B0065018AFM	Base Gasket	\$6.25	3JM-11351-01-00	
						IR014018AFM	Intake Gasket	\$3.80	1LR-13621	
						EX350064AM	Exhaust Gasket	\$13.29	3PA-14613-10-00	
		YFS200 Blaster	88-05	72.5 mm	<b>Bottom End Kit</b>	<b>List Price</b>	<b>Component Part#</b>	<b>Component Description</b>	<b>List Price</b>	<b>OEM Part #</b>
					C7093BE	\$70.74	OP032018AFM	Oil Pump Cover Gasket	\$4.77	126-13116-01-00
					EC316032AFM	Clutch Cover Gasket	\$18.12	3JM-15451-11-00/2XJ-15411-00-00		
					R19X2V	Oil Fill Plug O-ring 19X2.4	\$2.50	93210-19123-00		
					WA120	Drain Plug Gasket	\$0.83	90201-12172-00		
			<b>Oil Seal Kit</b>	<b>List Price</b>	<b>Component Part#</b>	<b>Component Description</b>	<b>List Price #</b>	<b>OEM Part #</b>		
			C7093OS	\$44.52	OS112	Right Crank Seal 32X44X9	\$10.68	93103-32099-00		
					OS124	Left Crank Seal 25X44X8	\$10.68	93102-25331-00		
					OS225	Output Shaft Seal 20X30X5	\$5.03	93102-20143-00		
					OS262	Oil Pump Seal 10X21X5	\$2.60	93101-10001-00		
					OS354	Shift Shaft Seal 12X21X4	\$4.46	93101-12173-00		
					OS355	Clutch Actuator Seal 14X25X5	\$5.07	93104-14004-00		
					OS356	Start Shaft Seal 20X38X5	\$6.00	93109-20014-00		
YFM225	86-88	71 mm	<b>Top End Kit</b>	<b>List Price</b>	<b>Component Part#</b>	<b>Component Description</b>	<b>List Price</b>	<b>OEM Part #</b>		
			C7253	\$35.72	H0066043F	Head Gasket	\$19.82	59V-11181-00-00		
					B0067020F	Base Gasket	\$5.34	4BD-11351-00-00		





# ATV Gaskets



Cometic Gasket - An Exclusive NASCAR Performance® Product

## YAMAHA YFM225

Model	Year	Bore Size	Top End Kit	List Price	Component Part#	Component Description	List Price	OEM Part #
YFM225	86-88	71 mm	C7253	\$35.72	H0066043F	Head Gasket	\$19.82	59V-11181-00-00
					B0067020F	Base Gasket	\$5.34	4BD-11351-00-00
TriZ250 Tri Moto	85-86	71 mm	C7153	\$35.72	H0269043F	Head Gasket	\$24.75	38W-11181-00-00
					B0172020F	Base Gasket	\$6.25	39X-11351-01-00
					IR017020F	Intake Gasket	\$3.80	80L-13621-01-00
YFA250 Breeze	89-95	50 mm	C7255	\$35.71	H0312043F	Head Gasket	\$17.38	3GH-11181-00-00
					B0187020F	Base Gasket	\$4.65	3FA-11351-10-00
YFM250 Timberwolf 2WD/4WD	92-03	72 mm	C7254	\$35.72	H0066043F	Head Gasket	\$19.82	59V-11181-00-00
					B0067020F	Base Gasket	\$5.34	4BD-11351-00-00
YFM250 Moto-4	89-91	71 mm	C7256	\$35.72	H0066043F	Head Gasket	\$19.82	59V-11181-00-00
					B0067020F	Base Gasket	\$5.34	4BD-11351-00-00

## YAMAHA YFM225

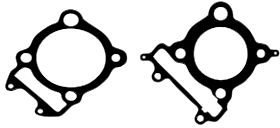

Base Model	Year	Head Bore Size	EST Top End Kit	List Price	Component Part#	Component Description	List Price	OEM Part #
YFM250R Raptor	08-13	74 mm	C3223-EST	\$76.70	H2760040S	Head Gasket	\$31.15	5XT-11181-00-00
		76 mm	C3224-EST	\$76.70	H2760SP2040S	Head Gasket 76mm	\$31.15	5XT-11181-00-00
		78 mm	C3225-EST	\$76.70	H2760SP3040S	Head Gasket 78mm	\$31.15	5XT-11181-00-00
		80mm	C3226-EST	\$76.70	H2760SP1040S	Head Gasket 80mm	\$31.15	5XT-11181-00-00
		81mm	C3236-EST	\$76.70	H2760SP5040S	Head Gasket 81mm	\$31.15	5XT-11181-00-00
					B0936020RC	Base Gasket	\$11.81	4D3-11351-00-00
					EX817	Exhaust Gasket	\$11.28	3GD-14613-00
					EC019018AFM	Cam Chain Tensioner Gasket	\$2.04	4FM-12213-00
					EC1230032AFM	Head Block Off Plate Gasket	\$1.13	5XT-14815-00-00
					R013B	Cam O-ring	\$1.19	93210-11453-00
					R046B	Cam Gear Cover O-ring	\$11.34	93211-05471-00
					R127V	Intake O-Ring Seal	\$3.92	5PA-14642-00-00
					R228V	Tappet Cover O-Ring	\$3.92	93210-54001-00
					R904V	Rocker Shaft O-ring	\$1.19	93210-09350
					WA114	Head Drain Gasket	\$3.02	90430-06014-00
					3187V	Valve Seals 2 Req.	\$3.02	5H0-12119-00-00
YFZ350 Banshee	87-05	65.5 mm	C7094	\$31.91	H0275010S	Head Gasket 65.5 mm Bore	\$22.37	2GU-11181-00-00
		66.5 mm	C7275	\$31.91	H0311010S	Head Gasket 66.5mm Bore	\$22.37	2GU-11181-00-00
		68 mm	C7316	\$31.91	H0442010S	Head Gasket 68mm	\$22.37	2GU-11181-00-00
		69.5 mm	C7710	\$31.91	H0745010S	Head Gasket 69.5mm Bore	\$22.37	2GU-11181-00-00
		71 mm	C7607	\$31.91	H0418010S	Head Gasket 71mm Bore	\$22.37	2GU-11181-00-00
					B0066012F	High Comp. Base Gasket 2 Req.	\$9.32	3GG-11351-00-00
					B0066018AFM	Base Gasket 2 Req.	\$9.32	3GG-11351-00-00
					IR019018AFM	Intake Gasket 2 Req.	\$3.80	55K-13621-00-00
					R224V	Exhaust O-Ring 2 Req.	\$1.19	93210-45742-00
					WP118032AFM	Water Outlet Gasket	\$2.61	3XV-12435-00-00
			<b>Bottom End Kit w/Oil Seals</b>	<b>List Price</b>	<b>Component Part#</b>	<b>Component Description</b>	<b>List Price #</b>	<b>OEM Part #</b>
			C7094BE	\$86.17	WP072020F	Water Pump Cover Gasket	\$6.25	3GG-12428-01-00
					R19X2V	Oil Fill Plug O-ring	\$1.99	93210-19123-00
					EC318020F	Inner Clutch Cover Gasket	\$10.91	3GG-15461-02-00
					WA120	Drain Plug Gasket	\$ .83	90430-14043-00
			<b>Oil Seal Kit</b>	<b>List Price</b>	<b>Component Part#</b>	<b>Component Description</b>	<b>List Price #</b>	<b>OEM Part #</b>
			C7094OS	\$56.56	OS126	Right Crank Seal 23x40x10	\$11.87	93103-40077-00
			<b>Crank Seal Kit</b>	<b>List Price</b>	<b>Component Part#</b>	<b>Component Description</b>	<b>List Price #</b>	<b>OEM Part #</b>
			C7673	\$19.20	OS125	Right Crank Seal 38X62X12	\$9.47	93103-40077-00
					OS225	Kickstart Shaft Seal 20x30x5	\$5.03	93102-20484-00
					OS226	Impeller Shaft Seal 10x31x13.5	\$14.11	93103-10147-00
					OS227	Shift Shaft Seal 12x22x5	\$2.67	93102-12106-00/
								93102-12321-00
					OS268	Output Shaft Seal 35x62x6	\$8.34	93102-35369-00
					OS357	Clutch Actuator Seal 17x28x6	\$5.07	93102-17004-00





# ATV Gaskets



Cometic Gasket - An Exclusive NASCAR Performance® Product

## YAMAHA YFM350



Model	Year	Bore Size	EST	List Price	Component Part#	Component Description	List Price	OEM Part #
			<b>Top End Kit</b>					
YFM350	04-06	84 mm	C7096-EST	\$71.49	H0067027S	Head Gasket Multi-Layer-Steel	\$31.15	1UY-11181-01-00
Bruin		85 mm	C3159-EST	\$71.49	H0067043F	Head Gasket Fiber	\$22.32	1UY-11181-01-00
YFM350	04-14				H0067SPA027S	Head Gasket 85mm Steel	\$31.15	1UY-11181-01-00
Raptor					B0068020F	Base Gasket	\$6.25	4KB-11351-00-00
Wolverine					EC998032AFM	Cam Chain Tensioner Gasket	\$2.33	3GD-12213-00-00
YFM350	87-04				3230V	Valve Seals 2 Req.	\$6.48	M01-12129-00-00
Warrior					R86X3V	Cam Cover O-ring	\$6.00	93211-06635-00
YFM350	95-06				R57X2V	Tappet Cover O-ring 2 Req.	\$3.20	93210-57634-00
YFM350/	87-06				R106X2V	Base O-ring	\$5.71	93210-86509-00
400 Big Bear, Moto 4					R031B	Intake O-ring	\$4.65	93210-44545-00
					R012B	Base Dowel O-ring	\$0.51	93210-18322-00

Component Part#	Component Description	List Price #	OEM Part #
WA080043C	Case Bolt Crush Washer	\$0.57	90430-06014-00
OP031020F	Oil Pump Gasket	\$18.56	3GD-13329-00-00
WA080043C	Drain Plug O-ring	\$0.57	93210-35512-00
WA116	Oil Line Crush Washer	\$3.02	90430-08119-00
R227V	Oil Pump Cover Gasket	\$3.92	93210-54175-00
R114V	Shift Shaft O-ring	\$1.19	93210-15566-00
R020V	Neutral Drum Shift Detent O-ring	\$1.19	90430-14194-00
R116B	Fill Plug O-ring	\$1.13	93210-19522-00
R027V	Timing Mark O-ring	\$1.19	93210-14369-00
Component Part#	Component Description	List Price #	OEM Part #
OS351	Mag Oil Seal 28x52x8.2	\$5.83	93102-28017-00
OS347	Shift Shaft Oil Seal 14x26x6	\$4.46	93102-14209-00
OS352	Neutral Drum Oil Seal 15x25x5	\$4.36	93102-15212-00
OS348	Output Shaft Oil Seal 35x45x6	\$8.34	93102-35393-00
OS350	Idler Shaft Oil Seal 20x52x3.5	\$5.83	93104-20068-00
OS349	Trans Main Shaft Oil Seal 17x40x3.5	\$4.57	93104-17094-00
OS286	Clutch Actuator Seal 12x18x5	\$4.29	93102-12224-00
Component Part#	Component Description	List Price	OEM Part #
EC314032AFM	Clutch Cover Gasket	\$18.56	3GD-15461-00-00
EC315032AFM	Mag Cover Gasket	\$18.56	3GD-15451-00-00



Model	Year	Bore Size	EST	List Price	Component Part#	Component Description	List Price	OEM Part #
			<b>Top End Kit</b>					
YFM400	00-07	85.5 mm	C3213-EST	\$64.66	H2464027S	Head Gasket	\$35.72	5GH-11181-00-00
KODIAK/GRIZZLY					B0918031F	Base Gasket	\$11.87	5GH-11351-00
					EX130	Exhaust Gasket	\$7.56	3GD-14613-00-00
					EC998032AFM	Cam Chain Tensioner Gasket	\$2.33	3GD-12213-00-00
					R012B	Rocker Arm O-ring 2 Req.	\$0.51	93210-09165-00
					R106X2V	Cam Cover O-ring	\$5.71	93211-06635-00
					R116V	Base Dowel O-ring	\$1.19	93210-18322-00
					R141SB	Valve Cover O-ring	\$18.99	93210-57634-00
					R89X2.5V	Base O-ring	\$4.43	93210-89447-00
					3230V	Valve Seals 2 Req.	\$6.48	M01-12129-00-00
					WA118	Head Drain Plug Washer	\$1.88	90430-06014-00

**All Component Parts can be purchased individually.**



**WARNING:** Cancer and Reproductive Harm [www.P65Warnings.ca.gov](http://www.P65Warnings.ca.gov)



# ATV Gaskets



Cometic Gasket - An Exclusive NASCAR Performance® Product

## YAMAHA YFZ450

Model	Year	Bore Size	EST	List Price	Component Part#	Component Description	List Price #	OEM Part #				
YFZ450	04-08	96 mm	<b>Top End Kit</b>									
			C3066-EST	\$89.38	H2144027S	96mm Head Gasket	\$40.93	5TA-11181-00-00				
			C3445-EST	\$89.38	H2144SP1027S	97mm Head Gasket	\$40.93	5TA-11181-00-00				
			C3068-EST	\$89.38	H1683027S	98mm Head Gasket	\$40.93	5TA-11181-00-00				
					B0626020RC	Base Gasket	\$11.81	5TA-11351-00-00				
					EX641	Exhaust Gasket	\$10.96	3VD-14613-01-00				
					EC019018AFM	Cam Chain Tensioner Gasket	\$2.04	4FM-12213-00				
					3179V	ntake Valve Seals 3 Req.	\$5.50 ea.	4SV-12119-00-00				
					3234V	Exhaust Valve Seals 2 Req.	\$5.50 ea.	33M-12119-00-00				
					WA082063C	2 Req.	\$1.93	90430-10171-00				
					WA114	2 Req.	\$3.02	90430-06014-00				
					WA116	4 Req.	\$1.06	90201-08087-00				
					R19X2V	Base dowel O-ring	\$2.50	93210-19758-00				
					<b>Bottom End Kit</b>	<b>List Price</b>	<b>Component Part#</b>	<b>Component Description</b>	<b>List Price #</b>	<b>OEM Part #</b>		
					C3338	\$57.52	EC762032AFM	Inner Clutch Cover Gasket	\$8.69	5TA-15462-00-00		
							EC763032AFM	Outer Clutch Cover Gasket	\$9.94	5TA-15453-00-00		
							EC899032AFM	Mag Cover Gasket	\$5.91	5TG-15451-10-00		
							R10X2V	Center Case Dowel O-ring	\$1.59	93210-10197-00		
							R10X2V	Oil Pump Dowel O-ring	\$1.59	93210-10197-00		
							R10X2V	Oil Pump Tube O-ring	\$1.59	93210-10197-00		
							R12.5X2V	Oil Tube O-ring (Lg)	\$3.74	93210-12759-00		
							R13.5X2V	Timing Plug O-ring (Sm)	\$1.93	93210-14369-00		
							R19X2V	Inner Clutch O-rings	\$2.50	93210-19758-00		
							R22X2V	Counter Shaft O-ring	\$2.66	93210-22164-00/22298-00		
							R27X2V	Mag Cover Plug O-ring	\$1.86	93210-32172-00		
							R47X2.5V	Oil Filter Cover O-ring (Sm)	\$3.27	93210-47675-00		
							R60X3B	Water Pump Cover O-ring	\$3.21	93210-60426		
							R7X2V	4 Req.-Oil Pump O-rings (Sm)	\$2.16	93210-07003-00/07540-00		
				R8.5X1.5V	Oil tube O-rings (Med)	\$1.13	93210-09008-00					
				WA082063C	Drain Plug Gasket	\$1.93	90430-10171					
				<b>Component Part#</b>	<b>Component Description</b>	<b>List Price #</b>	<b>OEM Part #</b>					
				VC104	Valve Cover Gasket	\$23.80						
YFZ450R	09-19	95mm	<b>Top End Kit</b>	<b>List Price</b>	<b>Component Part#</b>	<b>Component Description</b>	<b>List Price</b>	<b>OEM Part #</b>				
			C7908-EST	\$73.79	H2477023S	Head Gasket 95mm	\$31.15	2S2-11181-00-00				
			C3178-EST	\$73.79	H2477SP1023S	Head Gasket 98mm	\$31.15	2S2-11181-00-00				
			C3279-EST	\$73.79	H2477SP4023S	Head Gasket 99mm	\$31.15	2S2-11181-00-00				
					B0849008S	Base Gasket	\$11.87	2S2-11351-00-00				
					3179V	Intake Valve Seal 3 Req.	\$5.50 ea.	4SV-12119-00-00				
					3234V	Exhaust Valve Seal 2 Req.	\$5.50 ea.	33M-12119-00-00				
					EC019018AFM	Cam Chain Tensioner Gasket	\$2.04	4FM-12213-00				
					EX696	Exhaust Gasket	\$10.28	3VD-14613-01-00				
					WA082063C	Oil Line Washers 2 Req.	\$1.93	90430-10171				
					WA114	Drain Plug Gasket	\$3.02	90430-06014				
					WA116	Oil Line Washers 4 Req.	\$1.06	90201-08087-00				
					<b>Bottom End Kit</b>	<b>List Price</b>	<b>Component Part#</b>	<b>Component Description</b>	<b>List Price #</b>	<b>OEM Part #</b>		
					C3419BE	\$57.42	EC1558032AFM	Inner Clutch Cover	\$8.69	18P-15462-00-00		
							EC1560018AFM	Stator Cover Gasket	\$3.07	18P-15463-00		
							R013V	Crankcase O-ring	\$1.03	93210-10197-00		
							R022B	Output Shaft O-ring	\$1.13	93210-25001-00		
							R114V	Timing Plug O-ring	\$1.19	93210-14369-00		
							R117V	Dip Stick O-ring	\$1.19	93210-19026-00		
							R127V	Crank Plug O-ring	\$3.92	93210-357A3-00		
							R133B	Oil Filter Bolt O-ring 3 Req.	\$1.13	93210-47675-00		
							R134V	Oil Filter O-ring	\$3.92	93210-47675-00		
							R214B	Starter Input O-rings	\$0.51	93210-24235		
							WA082063C	Drain Plug Gasket 2 Req.	\$1.93	90430-10148-00		
							WA114	Case Bolt Seal	\$3.02	90430-06014-00		
							WP370018AFM	Water Pump Gasket	\$5.19	18P-12428-00-00		
							<b>Oil Seal Kit</b>	<b>List Price</b>	<b>Component Part#</b>	<b>Component Description</b>	<b>List Price #</b>	<b>OEM Part #</b>
							C3419OS	\$27.15	OS348	Output Shaft Seal 34x45x6	\$8.34	93102-35393-00
						OS305	Crank End Oil Seal 14x22x6	5.77	93101-14164-00			
						OS286	Shift Shaft Seal 12x18x5	\$4.29	93102-12224-00			
						OS286	Clutch Pushrod Seal 12x18x5	\$4.29	93102-12224-00			
						OS354	Impeller Oil Seal 12x21x4	\$4.46	93101-12173-00			
				<b>Clutch &amp; Mag Kit</b>	<b>List Price</b>	<b>Component Part#</b>	<b>Component Description</b>	<b>List Price</b>	<b>OEM Part #</b>			
				C3419CM	\$20.62	EC1561032AFM	Mag Cover Gasket	\$10.68	18P-15451-00			
						EC1559032AFM	Outer Clutch Cover	\$9.94	18P-15453-00-00			



**WARNING:** Cancer and Reproductive Harm www.P65Warnings.ca.gov



# ATV Gaskets



Cometic Gasket - An Exclusive NASCAR Performance® Product

## YAMAHA YFM600

Model	Year	Bore Size	Top End Kit	List Price	Component Part#	Component Description	List Price	OEM Part #
YFM600	98-01	97 mm	C7213	\$29.35	H0267043F	Head Gasket 97mm	\$22.32	2KF-11181-01
Grizzly		98 mm	C7276	\$29.35	H0320043F	Head Gasket 98mm	\$22.32	2KF-11181-01
XT600	88-96	101 mm	C7277	\$29.35	H0321043F	Head Gasket 101mm	\$22.32	2KF-11181-01
					B0064020F	Base Gasket	\$7.16	1VJ-11351-00-00
					B1019010RC	Base Gasket	\$13.62	33D-11351-00-00
					EC019032AFM	Cam Chain Tensioner Gasket	\$2.04	4FM-12213-00-00
					EX1041042AM	Exhaust Gasket	\$4.65	33D-14613-00-00

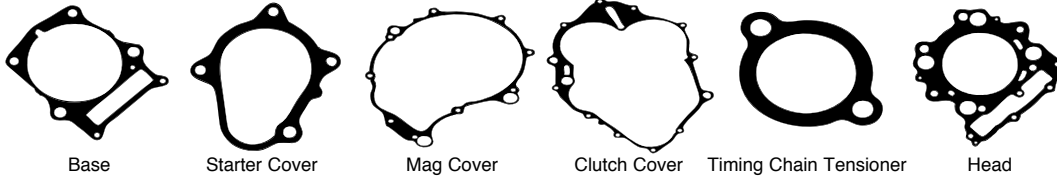

Model	Year	Bore Size	EST Top End Kit	List Price	Component Part#	Component Description	List Price	OEM Part #
YFM660R	01-05	100mm	C7044-EST	\$89.44	H1481SP2030S	Head Gasket 100mm Bore	\$27.26	3YF-11181-00
Raptor		101mm	C7900-EST	\$89.44	H1481030S	Head Gasket 101mm Bore	\$27.26	
Rhino 660 (SXS)	04-07	102mm	C7798-EST	\$89.44	H1191030S	Head Gasket 102mm Bore	\$27.26	
		103mm	C3042-EST	\$89.44	H2174030S	Head Gasket 103mm Bore	\$27.26	
<b>Fits Top End Only</b>			105mm	C7909-EST	\$89.44	H1191SP1030S	Head Gasket 105mm Bore	\$27.26
					B0532010RC	Base Gasket	\$8.69	3YF-11351
					EX361	Exhaust Gasket 2 Req.	\$5.50	3YF-14613-01-00
					EC584018AFM	Cam Chain Tensioner Gasket	\$3.58	4DW-12213-00
					3187V	Valve Seal 5 Req.	\$3.02	5H0-12119-00-00
					R016B	Radiator Hose O-ring	\$0.74	93210-18417-00
					R113B	Valve Cover Plug O-ring	\$1.19	93210-13657-00
					R114S	Oil Tank O-ring	\$3.92	93210-16629-00
					R116B	Cam Chain Tens. Cap O-ring	\$1.13	11101/93210
					R117B	Dipstick O-ring	\$0.42	93210-21190-00
					R124B	Tappet Cover O-ring	\$3.92	93210-32172-00
					R155S	Cylinder Base O-ring	\$3.92	11256/93211
					R71X2.5B	Intake Valve Adj. Cover O-ring	\$2.57	93210-71360-00
					WA081080C	Oil Line Washers 4 Req.	\$0.06	90430-08204
					WA082063C	Oil Line Washers 4 Req.	\$1.93	90430-10171
			<b>Bottom End Kit w/o crank seals</b>	<b>List Price</b>	<b>Component Part#</b>	<b>Component Description</b>	<b>List Price</b>	<b>OEM Part #</b>
			C3339	\$40.12	EC580060AFM	Starter Cover Gasket	\$4.02	5LP-15455-00
					EC581060AFM	Cover Gasket	\$11.18	5LP-15451-00
					C7800	Clutch Cover Gasket	\$19.14	5LP-15462-00
					OP092010FB	Oil Pump Cover Gasket	\$1.25	5LP-13329-00
					R027V	Crank Plug O-ring	\$0.74	93210-14369-00
					R031B	Intake O-ring	\$4.65	93210-44545-00
					R109B	Water Pump Impeller O-ring 2 Req.	\$1.13	11171/93210-77363
					R125V	Water Outlet- Oring	\$1.19	93210-33786-00
					R126B	Timing Plug O-ring	\$1.19	93210-357A3-00
					R12X2V	Out Put Shaft O-ring	\$4.09	93210-22298-00
					WA080043C	Drain Plug Washer	\$0.57	90430-06014-00



# ATV Gaskets



Cometic Gasket - An Exclusive NASCAR Performance® Product

## YAMAHA YFM660R

Model	Year	Bore Size	EST	List Price	Component Part#	Component Description	List Price	OEM Part #
YFM660R	01-05	100mm	C7044-EST	\$89.44	H1481SP2030S	Head Gasket 100mm Bore	\$27.26	3YF-11181-00
Raptor		101mm	C7900-EST	\$89.44	H1481030S	Head Gasket 101mm Bore	\$27.26	
Rhino 660	04-07	102mm	C7798-EST	\$89.44	H1191030S	Head Gasket 102mm Bore	\$27.26	
(SXS)		103mm	C3042-EST	\$89.44	H2174030S	Head Gasket 103mm Bore	\$27.26	
<b>Fits Top End Only</b>			105mm	C7909-EST	\$89.44	H1191SP1030S	Head Gasket 105mm Bore	\$27.26
					B0532010RC	Base Gasket	\$8.69	3YF-11351
					EX361	Exhaust Gasket 2 Req.	\$5.50	3YF-14613-01-00
					EC584018AFM	Cam Chain Tensioner Gasket	\$3.58	4DW-12213-00
					3187V	Valve Seal 5 Req.	\$3.02	5H0-12119-00-00
					R016B	Radiator Hose O-ring	\$0.74	93210-18417-00
					R113B	Valve Cover Plug O-ring	\$1.19	93210-13657-00
					R114S	Oil Tank O-ring	\$3.92	93210-16629-00
					R116B	Cam Chain Tens. Cap O-ring	\$1.13	11101/93210
					R117B	Dipstick O-ring	\$0.42	93210-21190-00
					R124B	Tappet Cover O-ring	\$3.92	93210-32172-00
					R155S	Cylinder Base O-ring	\$3.92	11256/93211
					R71X2.5B	Intake Valve Adj. Cover O-ring	\$2.57	93210-71360-00
					WA081080C	Oil Line Washers 4 Req.	\$0.06	90430-08204
					WA082063C	Oil Line Washers 4 Req.	\$1.93	90430-10171
			<b>Bottom End Kit w/o crank seals</b>	<b>List Price</b>	<b>Component Part#</b>	<b>Component Description</b>	<b>List Price</b>	<b>OEM Part #</b>
			C3339	\$40.12	EC580060AFM	Starter Cover Gasket	\$4.02	5LP-15455-00
					EC581060AFM	Cover Gasket	\$11.18	5LP-15451-00
					C7800	Clutch Cover Gasket	\$19.14	5LP-15462-00
					OP092010FB	Oil Pump Cover Gasket	\$1.25	5LP-13329-00
					R027V	Crank Plug O-ring	\$0.74	93210-14369-00
					R031B	Intake O-ring	\$4.65	93210-44545-00
					R109B	Water Pump Impeller O-ring 2 Req.	\$1.13	11171/93210-77363
					R125V	Water Outlet- Oring	\$1.19	93210-33786-00
					R126B	Timing Plug O-ring	\$1.19	93210-357A3-00
					R12X2V	Out Put Shaft O-ring	\$4.09	93210-22298-00
					WA080043C	Drain Plug Washer	\$0.57	90430-06014-00
			<b>Top End Kit</b>	<b>List Price</b>	<b>Component Part#</b>	<b>Component Description</b>	<b>List Price</b>	<b>OEM Part #</b>
YFM700	06-17	103mm	C3142-EST	\$89.44	H2449027S	Head Gasket 103mm	\$40.55	1S3-11181-00-00
YFM700F	07-15	104mm	C3143-EST	\$89.44	H2449SP2027S	Head Gasket 104mm	\$40.55	
Grizzly		105.5mm	C3144-EST	\$89.44	H2465027S	Head Gasket 105.5mm	\$40.55	
					B0855010RC	Base Gasket	\$9.47	1S3-11351-00-00
					EX361	Exhaust Gasket 2 Req.	\$5.50	3YF-14613-01-00
					R034V	Throttle Body O-ring	\$3.00	4WV-14147-10-00
					R0126V	Water Pump O-ring	\$1.19	93210-33786-00
					R131B	Thermostat O-ring	\$1.13	93210-41042-00
					R240V	Cam Cover O-ring	\$3.92	93210-96601-00
					R79X2.5V	Valve Cover O-rings 2 Req.	\$7.29	93210-78544-00
					3187V	Valve Seal 4 Req.	\$3.02	5H0-12119-00-00
					EC584018AFM	Cam Chain Tensioner Gasket	\$3.58	4DW-12213-00

All Component Parts can be purchased individually.

**WARNING:** Cancer and Reproductive Harm [www.P65Warnings.ca.gov](http://www.P65Warnings.ca.gov)





# ATV Gaskets



Cometic Gasket - An Exclusive NASCAR Performance® Product

## YAMAHA YFM700

Model	Year	Bore Size	Top End Kit	List Price	Component Part#	Component Description	List Price	OEM Part #
YFM700	16-17	103mm	C3599-EST	\$64.58	EC2098032AFM	Cam Chain Tensioner Gasket	\$2.46	2MB-E2213-00-00
Grizzly					MA0164	Cam Chain Tensionor	\$0.93	2MB-YFM700
YFM700						Crush Gasket		E21E2-00-00
Kodiak					B1306010RC	Cylinder Base Gasket	\$9.47	2MB-E1351-00-00
					H4173023S	103mm Bore Cyl. Head Gasket	\$40.55	2MB-E1181-00-00
					VC362018AFM	Valve Cover Breather Gasket	\$4.02	2MB-E131B-00-00
					EX045	Header Gasket	\$4.26	3EG-14613-00-00
					WA117	Oil Line Banjo Bolt	\$0.95	2MB-E1195-00-00
						Crush Gaskets		
					3250V	Exhaust Valve Seal	\$1.48	2MB-E2129-00-00
					3250V	Intake Valve Seal	\$1.48	2MB-E2119-00-00
					R125V	Water Outlet O-ring	\$1.19	2MB-E2843-00-00



# MX/Dirt • Off-Road Gaskets

## COBRA KING 50

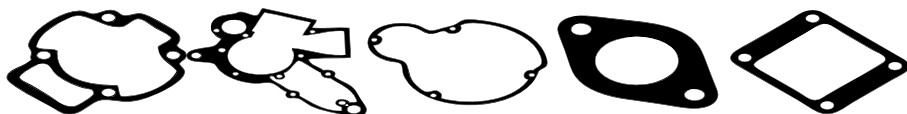

Base      Center Case      Ignition Cover      Exhaust      Intake

Model	Year	Bore Size	Top End Kit	List Price	Component Part#	Component Description	List Price	OEM Part #
KING 50	1998	O-RING	C3254	\$19.41	R010V	Head Cover O-rings 4 req.	\$0.40	ZCMUOR03
					R033B	Inner Head O-ring	\$2.86	ZCMUOR05
					R105X2B	Outer Head O-ring	\$2.57	ZCMUOR02
					B0848018AFM	Base Gasket	\$8.17	ZCKG0002
					B0848012F	High Compression Base	\$7.10	
					EX916059F	Exhaust Gasket	\$3.93	XCKG0001
			<b>Bottom End Kit w/o crank seals</b>	<b>List Price</b>	<b>Component Part#</b>	<b>Component Description</b>	<b>List Price</b>	<b>OEM Part #</b>
			C3307	\$29.22	EC1220060AFM	Clutch Cover Gasket	\$13.57	ZCMU0030
					EC1301012F	Center Case Gasket	\$10.68	ZCKG0012
					EC1302032AFM	Ignition Cover Gasket	\$8.69	ZCKG0101
					IR715032AFM	Intake Gasket	\$3.58	ECMU0049
KING 50	98-03	O-RING	<b>Top End Kit</b>	<b>List Price</b>	<b>Component Part#</b>	<b>Component Description</b>	<b>List Price</b>	<b>OEM Part #</b>
W/2PC			C3255	\$19.41	R010V	Head Cover O-rings 8 req.	\$0.40	ECMU0049
HEAD					R033B	Inner Head O-ring	\$2.86	ZCMUOR05
					R105X2B	Outer Head O-ring	\$2.57	ZCMUOR02
					R121V	Head Cover Coolant Seal O-ring	\$1.25	ZCMUOR08
					B0848018AFM	Base Gasket	\$8.17	ZCMU0030
					B0848012F	High Compression Base	\$7.10	ZCKG9902
					EX916059F	Exhaust Gasket	\$3.93	ZCKG0101
			<b>Bottom End Kit w/o crank seals</b>	<b>List Price</b>	<b>Component Part#</b>	<b>Component Description</b>	<b>List Price</b>	<b>OEM Part #</b>
			C3308	\$40.61	EC1220060AFM	Clutch Cover Gasket	\$13.57	ZCMU0030
					EC1301012F	98 Center Case Gasket	\$10.68	ZCKG0012
					EC1304020F	99-Up Center Case Gasket	\$14.25	ZCKG9902
					EC1302032AFM	Ignition Cover Gasket	\$8.69	ZCKG0101
					IR715032AFM	Intake Gasket	\$3.58	ECMU0049

All Component Parts can be purchased individually.



**WARNING:** Cancer and Reproductive Harm www.P65Warnings.ca.gov



# MX/Dirt • Off-Road Gaskets



Cometic Gasket - An Exclusive NASCAR Performance® Product

## COBRA CX50

Model	Year	Bore Size	Top End Kit	List Price	Component Part#	Component Description	List Price	OEM Part #					
CX50	13-15	O-Ring	C3602	\$36.18	R105X2B	Outer Head O-ring	\$2.57	ZCMUOR02					
					R033B	Combustion Chamber O-ring	\$2.86	ZCMUOR05					
					R024V	Upper Dome O-ring	\$1.19	ZCMUV024					
					R010V	Stud O-rings 4	\$0.40	ZCMUOR10					
					B0848031F	Base Gasket .031"	\$7.10	ZCMU0708					
					B0848020F	Base Gasket .020"	\$7.10	ZCMU0705					
					B0848015F	Base Gasket .015"	\$7.10	ZCKG0501					
					B0848012F	Base Gasket.012"	\$7.10	ZCMU0703					
					R026V	Exhaust Flange O-ring	\$1.19	ZCMUOR07					
					R125V	Header Flange O-ring 2	\$1.19	ZCMOTE11					
					<b>Bottom End Kit</b>		<b>List Price</b>	<b>Component Part#</b>	<b>Description</b>	<b>List Price</b>	<b>OEM Part#</b>		
						C3603	\$37.27	EC1982032AFM	Ignition Cover Gasket	\$8.69	ZCCS0002		
								EC1983020F	Crankcase Gasket	\$14.53	ZCCS0005		
								R018V	Sprocket Shaft Spacer O-ring	\$1.19	ZCDCOR01		
								WA116	Drain Plug Gasket	\$1.06	HCWC0000		
								EC1984060AFM	Clutch Cover Gasket	\$13.57	ZCMU0030		
								R12X2V	Kick Shaft O-ring	\$1.19	ZCMUB014		
								R12X2V	Oil Fil Plug O-ring	\$1.19	ZCMUB014		
					CX65	13-18	O-Ring	C3591	\$54.99	R88X2B	Outer Chamber O-ring	\$1.36	ZCC60009
										PV148032AFM	Power Valve Cover Gasket	\$2.97	ZCC60012
B1106012F	Base Gasket .3mm .011"	\$10.88	ZCC60303										
B1106015F	Base Gasket .4mm .015"	\$10.88	ZCC60304										
B1106020F	Base Gasket .5mm .019"	\$10.88	ZCC60305										
B1106031F	Base Gasket .8mm .031"	\$10.88	ZCC60308										
R125V	Expansion Chamber to Flange O-ring 2	\$1.19	ZCMOTE11										
R114V	Power Valve Solenoid Cap O-ring	\$1.10	ZCMU0114										
R010V	Cylinder Stud O-ring 5	\$0.40	ZCMUOR03										
R033B	Combustion Chamber O-ring	\$2.86	ZCMUOR05										
R026V	Flange to Head O-ring	\$1.19	ZCMUOR07										
R126V	Pipe to flange O-ring	\$1.19	ZCMUOR11										
R122V	Power Valve Plunger O-ring	\$1.25	ZCMUOR18										
R020V	Cylinder Dome Plug O-ring	\$1.19	ZCMUOR23										
<b>Bottom End Kit w/Oil Seals</b>		<b>List Price</b>	<b>Component Part#</b>	<b>Component Description</b>						<b>List Price #</b>	<b>OEM Part #</b>		
	C3591BE	\$53.30	EC2057018AFM	Inner Clutch Cover Gasket						\$7.58	ZCC60016		
			R12X2V	Drain Plug O-ring						\$1.19	ZCMUB014		
			R020V	Slave Cylinder O-ring						\$1.19	ZCMUOR25		
			R047B	Clutch Cover O-ring						\$5.30	ZCC60013		
			R018V	Output Shaft O-ring						\$1.19	ZCMUOR21		
			EC2056020F	Center Case Gasket	\$8.61	ZCC60014							
<b>Oil Seal Kit</b>		<b>List Price</b>	<b>Component Part#</b>	<b>Component Description</b>	<b>List Price #</b>	<b>OEM Part #</b>							
	C3591OS	\$34.80	OS366	Kick Start Shaft Seal	\$4.07	ECDC0078							
			OS227	Shift Shaft Seal	\$2.67	ECDC0026							
			OS131	Output Shaft Seal	\$7.10	ECDC0025							
			OS110	Crank Shaft Seals	\$9.47	ECDC0024							
			OS308	Water Pump Shaft Seal	\$5.89	ECC60175							

All Component Parts can be purchased individually.



**WARNING:** Cancer and Reproductive Harm [www.P65Warnings.ca.gov](http://www.P65Warnings.ca.gov)



# MX/Dirt • Off-Road Gaskets



Cometic Gasket - An Exclusive NASCAR Performance® Product

## COBRA CX50

Model	Year	Bore Size	Top End Kit	List Price	Component Part#	Component Description	List Price	OEM Part #			
CX50	13-15	O-Ring	C3602	\$36.18	R105X2B	Outer Head O-ring	\$2.57	ZCMUOR02			
					R033B	Combustion Chamber O-ring	\$2.86	ZCMUOR05			
					R024V	Upper Dome O-ring	\$1.19	ZCMUV024			
					R010V	Stud O-rings 4	\$0.40	ZCMUOR10			
					B0848031F	Base Gasket .031"	\$7.10	ZCMU0708			
					B0848020F	Base Gasket .020"	\$7.10	ZCMU0705			
					B0848015F	Base Gasket .015"	\$7.10	ZCKG0501			
					B0848012F	Base Gasket.012"	\$7.10	ZCMU0703			
					R026V	Exhaust Flange O-ring	\$1.19	ZCMUOR07			
					R125V	Header Flange O-ring 2	\$1.19	ZCMOTE11			
					<b>Bottom End Kit</b>		<b>List Price</b>	<b>Component Part#</b>	<b>Description</b>	<b>List Price</b>	<b>OEM Part#</b>
						C3603	\$37.27	EC1982032AFM	Ignition Cover Gasket	\$8.69	ZCCS0002
								EC1983020F	Crankcase Gasket	\$14.53	ZCCS0005
								R018V	Sprocket Shaft Spacer O-ring	\$1.19	ZCDCOR01
								WA116	Drain Plug Gasket	\$1.06	HCWC0000
			EC1984060AFM	Clutch Cover Gasket	\$13.57	ZCMU0030					
			R12X2V	Kick Shaft O-ring	\$1.19	ZCMUB014					
			R12X2V	Oil Fil Plug O-ring	\$1.19	ZCMUB014					
CX65	13-18	O-Ring	C3591	\$54.99	<b>Component Part#</b>	<b>Component Description</b>	<b>List Price</b>	<b>OEM Part #</b>			
					B1106SP1015F	Base Gasket .4mm .015"	\$10.88	ZCC60304			
					B1106SP1020F	Base Gasket .5mm .019"	\$10.88	ZCC60305			
					B1106SP1032AFM	Base Gasket .6mm .023" (compressed)	\$10.88	ZCC60306			
					B1106SP1031F	Base Gasket .8mm .031"	\$10.88	ZCC60308			
					R88X2B	Outer Chamber O-ring	\$1.36	ZCC60009			
					R033V	Combustion Chamber O-ring	\$2.96	ZCMUOR05			
					R020V	Cylinder Dome Plug O-ring	\$1.19	ZCMUOR23			
					R010V	Cylinder Stud O-ring 5	\$0.40	ZCMUOR03			
					R026V	Flange to Head O-ring	\$1.19	ZCMUOR07			
					R125V	Expansion Chamber to Flange O-ring 2	\$1.19	ZCMOTE11			
					R126V	Pipe to flange O-ring	\$1.19	ZCMUOR11			
					<b>Bottom End Kit w/Oil Seals</b>		<b>List Price</b>	<b>Component Part#</b>	<b>Component Description</b>	<b>List Price #</b>	<b>OEM Part #</b>
						C3591BE	\$53.30	EC2057018AFM	Inner Clutch Cover Gasket	\$7.58	ZCC60016
								EC2056020F	Center Case Gasket	\$8.61	ZCC60014
								R047B	Clutch Cover O-ring	\$5.30	ZCC60013
								IR1270031F	Intake Reed Gasket	2.18	ZCC60021
								R026V	Water Pump O-ring	\$1.19	ZCMUOR07
									Slave Cylinder O-ring		ZCMUOR35
								R12X2V	Clutch Drain/Fill Plug O-ring	\$1.19	ZCMUB014
								R018V	Output Shaft O-ring	\$1.19	ZCMUOR21
					<b>Oil Seal Kit</b>		<b>List Price</b>	<b>Component Part#</b>	<b>Component Description</b>	<b>List Price #</b>	<b>OEM Part #</b>
						C3591OS	\$34.80	OS366	Kick Start Shaft Seal	\$4.07	ECDC0078
								OS110	Left Crank Seal	\$9.47	ECDC0024
								OS131	Output Shaft Seal	\$7.10	ECDC0025
			OS227	Shift Shaft Seal	\$2.67	ECDC0026					
			OS308	Water Pump Shaft Seal	\$5.89	ECC60175					



# MX/Dirt • Off-Road Gaskets



Cometic Gasket - An Exclusive NASCAR Performance® Product

## GAS GAS 125

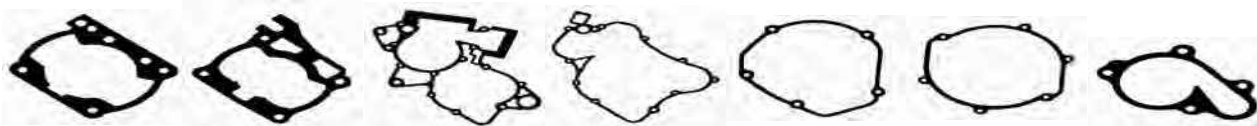

Model	Year	Base Bore Size	Top End Kit	Center Case	Inner Clutch	Ignition	Clutch	Water Pump	Power Valve					
Model	Year	Bore Size	Top End Kit	List Price	Component Part#	Component Description	List Price	OEM Part #						
125 EC,XC, DE,MC	01-11	O-RING	C3260	\$38.33	B0537020F	Base Gasket	\$5.34	ME120144000						
					IR271020F	Intake Gasket	\$9.94	ME120644005						
					PV106020F	Center Power Valve Gasket	\$3.80	ME120144006						
					PV107039F	Right Side Power Valve Gasket	\$3.80	ME120144007						
					R63X2V	Inner Head O-ring	\$4.57	ME120116065						
					R90X2V	Outer Head O-ring	\$7.50	ME120116060						
					WA135	Head Seal Washers 8 req.	\$0.80	T4008516						
			<b>Bottom End Kit w/o crank seals</b>	<b>List Price</b>	<b>Component Part#</b>	<b>Component Description</b>	<b>List Price</b>	<b>OEM Part#</b>						
			C3309	\$47.99	EC561020F	Center Case Gasket	\$16.13	ME120144001						
					EC562032AFM	Inner Clutch Cover Gasket	\$16.13	ME120144002						
					EC563020F	Ignition Cover Gasket	\$6.71	ME120144004						
					EC564031F	Clutch Cover Gasket	\$6.71	ME120144004						
					WP125020F	Water Pump Gasket	\$4.94	ME120144008						
200/250/300 EC/MC/SM XC,EC200 XC,EC250 XC,EC300 EC200, DE200, EC200 Hobby, EC250, EC250 Race, DE250, MC250, EC300, DE300		O-RING	C3261	\$45.99	R045V	Outer Head O-Ring 200	\$2.97	M01619135						
					B0403020F	Base Gasket	\$6.58	ME25644000						
					IR123032AFM	Intake Gasket	\$2.84	25644005						
					PV089020F	Left Side Power Valve Gasket	\$4.65	ME25644006						
					PV090039F	Right Side Power Valve Gasket	\$1.99	ME25644007						
						Right Power Valve Gasket		ME25610002						
					B0403015F	Base Gasket .38mm	\$6.58	ME25644009						
					B0403012F	Base Gasket .30mm	\$6.58	ME25644010						
					EX245043F	Exhaust Gasket	\$5.00	ME25644012						
					R046V	Outer Head O-Ring 250-300	\$1.19	ME25916060						
					R040V	Inner Head O-Ring 200-250	\$1.19	ME25916065						
					EC350031F	Thermostat Gasket	\$5.00	ME25944011						
					R041V	Inner Head O-Ring 300	\$5.30	ME30916065						
					WA135	Head Seal Washers 6 req.	\$0.80	T4008516						
								<b>Bottom End Kit w/o crank seals</b>	<b>List Price</b>	<b>Component Part#</b>	<b>Component Description</b>	<b>List Price</b>	<b>OEM Part#</b>	
								C3310	\$52.15	EC345039F	Outer Clutch Cover Gasket	\$9.94	ME25644003	
										EC346031F	Mag Cover Gasket	\$8.69	ME25644004	
					EC348020F	Inner Clutch Cover	\$9.94	ME25644002						
					EC349020F	Center Case Gasket	\$11.18	ME25644001						
					EC349031F	Center Case Gasket	\$11.18	ME25644001						
					R44X3S	Crank O-ring	\$2.82	ME250112011						
					WP082020F	Water Pump Gasket	\$2.38	ME25644008						

All Component Parts can be purchased individually.

**WARNING:** Cancer and Reproductive Harm [www.P65Warnings.ca.gov](http://www.P65Warnings.ca.gov)





# MX/Dirt • Off-Road Gaskets



Cometic Gasket - An Exclusive NASCAR Performance® Product

## GAS GAS



Head



Base



Cam Chain Tensioner

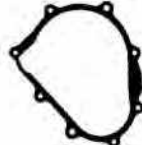

Mag Cover

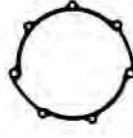

Outer Clutch Cover



Inner Clutch Cover

Model	Year	Bore Size	EST	List Price	Component Part#	Component Description	List Price	OEM Part #
EC250F Yamaha Motor	10-11	77 mm	<b>Top End Kit</b> C7905-EST	\$65.95	H1168SP3027S	Head Gasket	\$41.72	5NL-11181-00-00
		79 mm	C3057-EST	\$65.95	H1168SP2027S	Head Gasket 79mm Bore	\$41.72	
		81 mm	C3059-EST	\$65.95	H1271027S	Head Gasket 81mm Bore	\$41.72	
		83 mm	C3061-EST	\$65.95	H1272SP3027S	Head Gasket 84mm Bore	\$41.72	
		84 mm	C3120-EST	\$65.95	B0503020RC	Base Gasket	\$20.25	5NL-11351-00-00
					EX651	Exhaust Gasket	\$8.98	5NL-14613-00-00
					EC019032AFM	Cam Chain Tensioner Gasket	\$1.96	4FM-12213-00
					3179V	Exhaust Valve Seal 2 Req.	\$5.50 ea.	4SV-12119-00-00
					3233	VIntake Valve Seal 3 Req.	\$5.11 ea.	4TV-12119-00-00
			<b>Bottom End Kit w/Oil Seals</b>		<b>Component Part#</b>	<b>Component Description</b>	<b>List Price #</b>	<b>OEM Part #</b>
			C3057BE	\$74.14	EC554032AFM	Inner Clutch Cover Gasket	\$9.94	5NL-15462-00-00
					R011B	Oil Delivery O-ring (SM)	\$1.08	93210-07003-00/07540-00
					R013B	Oil Pump Seal O-Ring	\$1.19	93210-10197-00*
					R013B	Clutch Side Oil Feed Line O-Ring	\$1.19	93210-10197-00*
					R013B	Mag Side Oil Feed Line O-Ring	\$1.19	93210-10197-00*
					R014B	Oil Delivery Pipe O-Ring (Lg.)	\$1.08	93210-12759-00
					R016V	Case Dowel O-ring	\$1.19	93210-16772-00
					R109B	Oil Filter Cover O-Ring (Sm.)	\$1.13	93210-07135-00
					R10X2V	Centercase Dowel O-ring	\$1.59	93210-10197-00*
					R113B	Timing Plug O-ring	\$1.19	93210-14369-00
					R124B	Crank End Plug O-ring	\$3.92	93210-32172-00
					R134B	Oil Filter O-Ring (LG)	\$1.13	93210-47675-00
					R19X2V	Oil Fill Plug O-ring	\$2.50	93210-19123-00
					R903V	Oil Delivery Pipe O-ring (Med.)	\$1.19	93210-09008-00
					WA080043C	Coolant Drain Bolt Washer	\$0.57	90430-06014-00*
					WA082063C	Oil Drain Bolt Washer	\$1.93	90430-10188-00*/
			<b>Oil Seal Kit</b>		OS323	Kick Start Shaft Seal	\$4.46	93102-18278-00
			C3057OS	\$33.45	OS324	Countershaft Oil Seal	\$6.63	93102-28010-00
					OS242	Outer Water Pump Seal	\$4.34	93109-11073-00
					OS227	Inner Water Pump Seal	\$2.67	93102-12106-00
					OS236	Oil Pump Seal	\$4.23	93101-14164-00
					OS286	Gear Selector Seal	\$4.29	93102-12224-00
			<b>Clutch &amp; Mag Kit</b>		EC527020F	Magneto Cover Gasket	\$5.00	5NL-15451-00-00
			C3057CM	\$12.04	EC553020F	Outer Clutch Cover Gasket	\$4.65	5NL-15453-00-00
					<b>Component Part#</b>	<b>Component Description</b>	<b>List Price</b>	<b>OEM Part#</b>
					VC103	Valve Cover Gasket	\$17.80	

## HONDA CRF50

Model	Year	Bore Size	EST	List Price	Component Part#	List Price	OEM Part #	
CRF50	04-16	39 mm	<b>Top End Kit</b> C7974-EST	\$57.15	H1820040S	Head Gasket 39mm Bore	\$20.75	12251-GBJ-003
		41 mm	C7975-EST	\$57.15	H1821040S	Head Gasket 41mm Bore	\$20.75	
XR50	88-03				B0659020F	Base Gasket	\$7.16	12191-GW8-681
Z50R	82-87				3234V	Valve Stem Seals 2 Req.	\$5.50 ea.	12209-GB4-681
					EC1070018AFM	Right Side Head Cover Gasket	\$2.33	12394-GW8-680
					EC1071018AFM	Left Side Head Cover Gasket	\$2.33	12395-GW8-680
					EC1072018AFM	Center Head Cover Gasket	\$4.72	12391-GW8-680
					EX690064AM	Exhaust Gasket	\$2.56	18291-HB2-900
					R018B	Intake Runner O-Ring to Carb.	\$3.92	91302-001-020
					R14X2.5V	Dowel Pin O-Ring	\$1.13	91301-GB0-911
					R16X2V	Dowel Pin O-Ring	\$3.02	91303-035-000
					R219V	Valve Adjustment Cap 2 Req.	\$3.92	91302-001-020
					R27X2V	Intake Runner O-Ring to Head	\$1.86	91301-GK4-871
					R9X2V	Valve Guide Seals 2 Req.	\$1.59	91305-028-158
					<b>Component Part#</b>	<b>Component Description</b>	<b>List Price</b>	<b>OEM Part#</b>
					EC901032AFM	Clutch Cover Gasket	\$14.71	11394-GW8-680

All Component Parts can be purchased individually.



**WARNING:** Cancer and Reproductive Harm www.P65Warnings.ca.gov



# MX/Dirt • Off-Road Gaskets



Cometic Gasket - An Exclusive NASCAR Performance® Product

## HONDA XR70R

Model	Year	Bore Size	EST Top End Kit	List Price	Component Part#	Component Description	List Price	OEM Part #
XR70R	97-03	50 mm	C7300-EST	\$62.41	H2712040S	Head Gasket 50mm Bore	\$24.75	12200-GB5-931
	CRF70				04-12	B0659020F	Base Gasket	\$7.16
					3234V	Valve Stem Seals 2 Req.	\$5.50 ea.	12209-GB4-681
					EC1070018AFM	Right Side Head Cover Gasket	\$2.33	12394-GW8-680
					EC1071018AFM	Left Side Head Cover Gasket	\$2.33	12395-GW8-680
					EC1072018AFM	Center Head Cover Gasket	\$4.72	12391-GW8-680
					EX690064AM	Exhaust Gasket	\$2.56	18291-HB2-900
					R018B	Intake Runner O-Ring to Carb.	\$3.92	91302-001-020
					R14X2.5V	Dowel Pin O-Ring	\$1.13	91301-GB0-911
					R16X2V	Dowel Pin O-Ring	\$3.02	91303-035-000
					R219V	Valve Adjustment Cap 2 Req.	\$3.92	91302-001-020
					<b>Component Part#</b>	<b>Component Description</b>	<b>List Price</b>	<b>OEM Part #</b>
					EC901032AFM	Clutch Side Engine Cover	\$14.71	11394-GW8-680

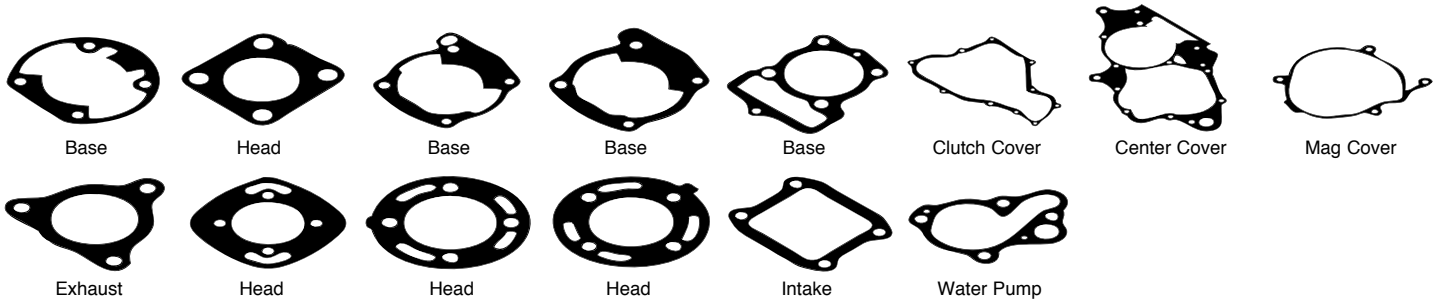

Model	Year	Bore Size	Top End Kit	List Price	Component Part#	Component Description	List Price	OEM Part #
CR80	80-82	51.5 mm	C7334	\$21.99	H0469020C	Head Gasket	\$17.15	12251-169-000
TC80	70-78				B0277020F	Base Gasket	\$4.65	12191-GC4-306
CR80	83	51.5 mm	<b>Top End Kit</b>	<b>List Price</b>	<b>Component Part#</b>	<b>Component Description</b>	<b>List Price</b>	<b>OEM Part #</b>
			C7000	\$21.99	H0001020C	Head Gasket	\$17.15	12251-GC4-307
					B0001020F	Base Gasket	\$4.65	12191-GC4-700
CR80	84	51.5 mm	<b>Crank Seal Kit</b>	<b>List Price</b>	<b>Kit Components</b>	<b>Component Description</b>	<b>List Price</b>	<b>OEM Part#</b>
			C7653	\$16.58	OS103	20X32X7 Left Side Oil Seal	\$9.47	91205-166-004
					OS104	22X40X8 Right Side Oil Seal	\$7.10	91206-GC4-711
CR80	85	49 mm	<b>Top End Kit</b>	<b>List Price</b>	<b>Component Part#</b>	<b>Component Description</b>	<b>List Price</b>	<b>OEM Part #</b>
			C7001	\$21.99	H0001020C	Head Gasket	\$17.15	12251-GC4-307
					B0002020F	Base Gasket	\$4.65	12191-GC4-700
CR80	85	49 mm	<b>Crank Seal Kit</b>	<b>List Price</b>	<b>Kit Components</b>	<b>Component Description</b>	<b>List Price</b>	<b>OEM Part#</b>
			C7653	\$16.58	OS103	20X32X7 Left Side Oil Seal	\$9.47	91205-166-004
					OS104	22X40X8 Right Side Oil Seal	\$7.10	91206-GC4-711
CR80	85	49 mm	<b>Top End Kit</b>	<b>List Price</b>	<b>Component Part#</b>	<b>Component Description</b>	<b>List Price</b>	<b>OEM Part #</b>
			C7002	\$19.14	H0002043F	Head Gasket	\$14.87	12251-GC4-307
					B0003020F	Base Gasket	\$4.65	12191-GC4-308
CR80	85	49 mm	<b>Crank Seal Kit</b>	<b>List Price</b>	<b>Kit Components</b>	<b>Component Description</b>	<b>List Price</b>	<b>OEM Part#</b>
			C7653	\$16.58	OS103	20X32X7 Left Side Oil Seal	\$9.47	91205-166-004
					OS104	22X40X8 Right Side Oil Seal	\$7.10	91206-GC4-711

All Component Parts can be purchased individually.

**WARNING:** Cancer and Reproductive Harm www.P65Warnings.ca.gov



# MX/Dirt • Off-Road Gaskets



Cometic Gasket - An Exclusive NASCAR Performance® Product

## HONDA CR80

Model	Year	Bore Size	Top End Kit	List Price	Component Part#	Component Description	List Price	OEM Part #
CR80	86-91	48 mm	C7003	\$26.80	H0003043F	Head Gasket	\$14.87	12251-GS2-781
					B0003020F	Base Gasket	\$4.65	12191-GC4-308
					EX002042AM	Exhaust Gasket	\$4.65	18291-GC4-600
					IR001018AFM	Intake Gasket	\$3.80	14132-904-600
			<b>Crank Seal Kit</b>	<b>List Price</b>	<b>Kit Components</b>	<b>Component Description</b>	<b>List Price</b>	<b>OEM Part#</b>
			C7653	\$16.58	OS103	20X32X7 Left Side Oil Seal	\$9.47	91205-166-004
					OS104	22X40X8 Right Side Oil Seal	\$7.10	91206-GC4-711
			<b>Top End Kit</b>	<b>List Price</b>	<b>Component Part#</b>	<b>Component Description</b>	<b>List Price</b>	<b>OEM Part #</b>
CR80	92-02	48 mm	C7126	\$26.80	H0266010S	Head Gasket 48mm Bore	\$16.75	12251-GS2-621
CR80Expert	96-02	49 mm	C7305	\$26.80	H0440010S	Head Gasket 49mm Bore	\$16.75	
CR85	03-07	51 mm	C7932	\$26.80	H1698010S	Head Gasket 51mm Bore	\$16.75	
		52 mm	C7315	\$26.80	H0449010S	Head Gasket 52mm Bore	\$16.75	
					B0004018AFM	Base Gasket	\$9.32	12191-GBF-830
					B0004012F	Base Gasket High Compression	\$9.32	12191-GBF-830
					EX002042AM	Exhaust Gasket	\$4.65	18291-GC4-600
					IR001018AFM	Intake Gasket	\$3.80	14132-904-600
					R38X3V	Exhaust O-rings 03-Up	\$3.79	91304-GBF-K41
					WA138	Exhaust Washer 03-Up	\$1.02	18309-GBF-K40
			<b>Bottom End Kit w/Oil Seals</b>	<b>List Price</b>	<b>Component Part#</b>	<b>Component Description</b>	<b>List Price</b>	<b>OEM Part #</b>
			C7126BE	\$62.29	EC183020F	Center Case Gasket	\$14.87	11191-GBF-830
					WP03200032AFM	Water Pump Gasket	\$3.74	19229-GBF-840
					WA133	Water Pump Drain Washer	\$0.90	90543-273-000
					WA137	Drain Plug Washer	\$1.53	90407-259-000
					R12X2.5B	Oil Fill Plug O-ring 11.9x2.2	\$4.09	91370-461-000
			<b>Oil Seal Kit</b>	<b>List Price</b>	<b>Component Part#</b>	<b>Component Description</b>	<b>List Price</b>	<b>OEM Part #</b>
			C7126OS	\$35.07	OS103	Crank Seal 20x32x7	\$9.47	91205-GC4-711
					OS104	Crank Seal 22x40x8	\$7.10	91206-GC4-711
					OS197	Shift Shaft Seal 14x24x6	\$2.46	91202-444-023
					OS203	Output Shaft Seal 17x28x7	\$3.26	91201-415-013
					OS242	Water Pump Shaft Seal 12x25x7	\$2.67	91211-KA3-761
					OS245	Start Shaft Seal 15x25x6	\$3.94	91211-671-003
					OS246	Impeller Shaft Seal 12x21x5	\$2.86	91201-035-015
					OS247	Clutch Actuator Seal 12x18x5	\$3.31	91204-KKO-003
			<b>Clutch &amp; Mag Kit</b>	<b>List Price</b>	<b>Component Part#</b>	<b>Component Description</b>	<b>List Price</b>	<b>OEM Part #</b>
			C7126CM	\$11.18	EC1820032AFM	Clutch Cover Gasket	\$7.44	11393-GBF-830
					EC192063N	Mag Cover Gasket	\$3.74	11342-GC4-710

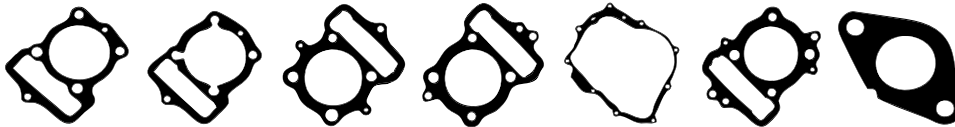

Base Base Head Head Right Case Cover Head Intake

Model	Year	Bore Size	Top End Kit	List Price	Component Part#	Component Description	List Price	OEM Part #
XL80	80-85	50 mm	C7230	\$21.76	H0336043F	Head Gasket 50mm Bore	\$18.56	12251-GN1-880
XR80	79-84				B0192020F	Base Gasket	\$8.69	12191-GN1-730
XR80R	85-91							
XR80Z A/B	79-81							
			<b>EST Top End Kit</b>	<b>List Price</b>	<b>Component Part#</b>	<b>Component Description</b>	<b>List Price</b>	<b>OEM Part #</b>
CRF80F	04-13	54 mm	C7231-EST	\$54.80	H2598010S	Head Gasket 50mm Bore	\$13.74	12251-GN1-A41
XR80R	92-03				3231V	Valve Stem Seals 2 req.	\$6.48 ea.	12208-413-003
					B0192020RC	Base Gasket	\$8.69	12191-GN1-730
					IR575032AFM	Intake Gasket	\$4.77	16229-GN1-A41
					R10X2V	Valve Guide O-rings 2 req.	\$1.59	91301-200-000
					EX784080C	Exhaust Gasket	\$3.35	18291-KZ1-670
					<b>Component Part#</b>	<b>Component Description</b>	<b>List Price</b>	<b>OEM Part #</b>
					EC1074018AFM	Clutch Cover Gasket	\$2.38	11393-KN4-750



# MX/Dirt · Off-Road Gaskets



Cometic Gasket - An Exclusive NASCAR Performance® Product

## HONDA XL100



Model	Year	Bore Size	Top End Kit	List Price	Component Part#	Component Description	List Price	OEM Part #
XL100	79-85	55 mm	C7988	\$26.80	H0329040S	Head Gasket 55mm Bore	\$20.75	12251-KA8-405
XR100	81-91	58 mm	C7985	\$26.80	H0329SP1040S	MLS Head Gasket 58mm Bore	\$20.75	12251-KA8-405
					B0194020F	Base Gasket	\$13.69	12191-KN4-750

			EST	Top End Kit	List Price	Component Part#	Component Description	List Price	OEM Part #
CRF100	04-13	55 mm	C7989-EST	\$65.53	H0330010S	MLS Head Gasket 55mm Bore	\$24.75	12251-KN4-751	
XR100	92-03	58 mm	C7986-EST	\$65.53	H0330SP1010S	MLS Head Gasket 58mm Bore	\$24.75	12208-413-003	
					3231V	Valve Stem Seals 2 req.	\$6.48 ea.	12191-KN4-750	
					B0194020F	Base Gasket	\$7.16	16229-GN1-A41	
					IR575032AFM	Intake Gasket	\$4.77	91301-200-000	
					R10X2V	Valve Guide O-rings 2 req.	\$1.59	91302-401-000	
					R30X3.5B	Intake O-ring	\$3.43		
					Component Part#	Component Description	List Price	OEM Part #	
					EC1074018AFM	Clutch Cover Gasket	\$2.38	11393-KN4-750	

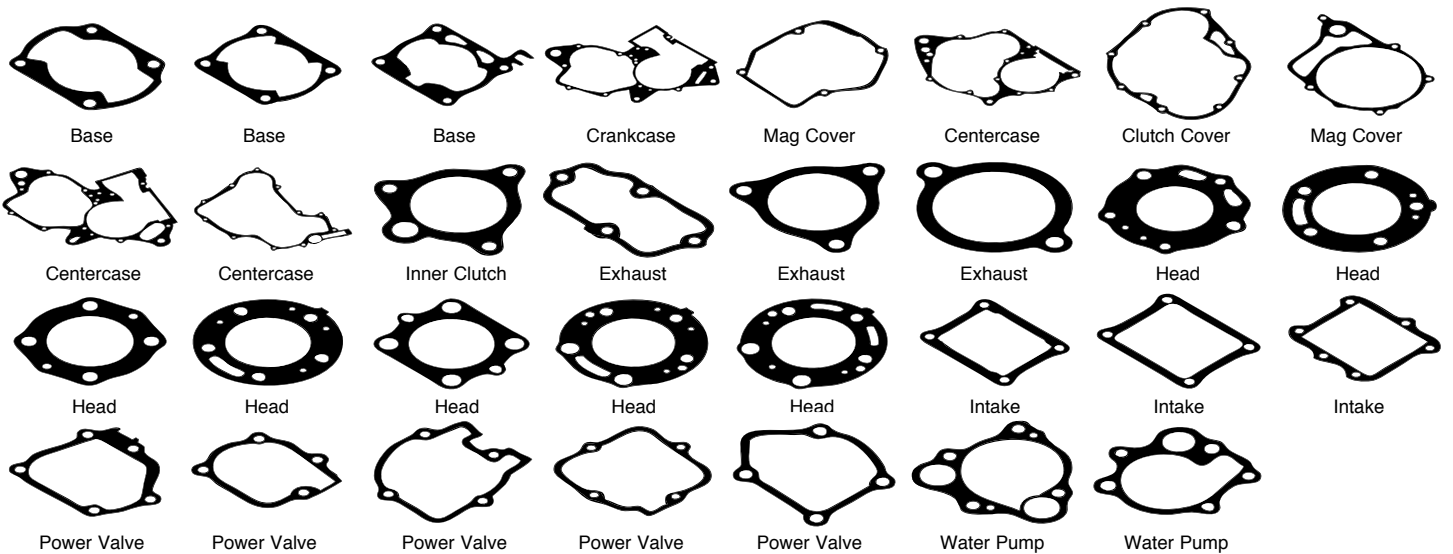

Model	Year	Bore Size	Top End Kit	List Price	Component Part#	Component Description	List Price	OEM Part #
CR125	73-78	58 mm	C7465	\$30.84	H0216020C	Head Gasket 58mm Bore	\$24.24	12251-360-000
MT125					B0345020F	Base Gasket	\$6.25	12191-373-306
CR125	79-80	57.7 mm	C7466	\$26.80	H0739020C	Head Gasket 57.7mm Bore	\$24.24	12251-466-000
					B0351020F	Base Gasket	\$6.25	12191-444-306
					EX419043F	Exhaust Gasket	\$4.77	18291-444-306
					IR214060AFM	Intake Gasket Reed to Case	\$5.63	14132-444-306
					IR215060AFM	Intake Gasket Reed to Carb Boot	\$5.63	14131-444-306
			Bottom End Kit w/o crank seals	List Price	Component Part#	Component Description	List Price	OEM Part #
			C3312	\$35.35	EC533020F	Center Case Gasket	\$14.87	11191-444-306
					EC534020F	Clutch Cover Gasket	\$13.97	11394-444-306
					EC670060AFM	Mag Cover Gasket	\$14.87	11395-444-306
CR125	81	56 mm	C3168	\$31.68	H1902043F	Head Gasket 56mm Bore	\$17.83	12251-KA3-306
					B0351018AFM	Base Gasket	\$6.25	12191-444-306
					EX419043F	Exhaust Gasket	\$4.77	18291-444-306
					IR214060AFM	Intake Gasket Reed to Case	\$5.63	14132-444-306
					IR215060AFM	Intake Gasket Reed to Carb Boot	\$5.63	14131-444-306

All Component Parts can be purchased individually.

**WARNING:** Cancer and Reproductive Harm [www.P65Warnings.ca.gov](http://www.P65Warnings.ca.gov)





# MX/Dirt • Off-Road Gaskets



Cometic Gasket - An Exclusive NASCAR Performance® Product

## HONDA CR125

Model	Year	Bore Size	Top End Kit	List Price	Component Part#	Component Description	List Price	OEM Part #
CR125	82	56 mm	C3430	\$35.72	H1715043F	Head Gasket 56mm Bore	\$17.38	12251-KA3-307
					B0351018AFM	Base Gasket	\$6.25	12191-444-306
					EX419043F	Exhaust Gasket	\$4.77	18291-444-306
					IR214060AFM	Intake Gasket Reed to Case	\$5.63	14132-444-306
					IR215060AFM	Intake Gasket Reed to Carb Boot	\$5.63	14131-444-306
					EX419043F	Exhaust Gasket	\$4.77	18291-444-306
CR125	83	57 mm	Top End Kit C7118	List Price \$21.76	Component Part# H0004043F	Component Description Head Gasket 57mm Bore	List Price \$17.38	OEM Part # 12251-KA3-308
					B0005020F	Base Gasket	\$5.34	12191-KA3-306
CR125	84-85	57 mm	Top End Kit C7005	List Price \$31.91	Component Part# H0004043F	Component Description Head Gasket 57mm Bore	List Price \$17.38	OEM Part # 12251-KA3-308
					B0006020F	Base Gasket	\$5.34	12191-KA3-740
					EX003042AM	Exhaust Gasket	\$4.65	18359-K56-000
					IR002020F	Intake Gasket Reed to Case	\$3.80	14131-KA3-710
					IR003018AFM	Intake Gasket Reed to Carb Boot	\$3.80	14132-K56-701
CR125	86	56 mm	Top End Kit C7006	List Price \$31.91	Component Part# H0005043F	Component Description Head Gasket 56mm Bore	List Price \$17.38	OEM Part # 12251-KS6-405
					B0007020F	Base Gasket	\$5.34	12191-KA3-307
					EX003042AM	Exhaust Gasket	\$4.65	18359-K56-000
					IR003018AFM	Int. Gasket Reed to Carb Boot	\$3.80	14132-K56-701
CR125	87	56 mm	Top End Kit C7007	List Price \$35.72	Component Part# H0006043F	Component Description Head Gasket 56mm Bore	List Price \$17.38	OEM Part # 12251-KZ4-701
					B0008020F	Base Gasket	\$5.34	12191-KS6-701
					EX004042AM	Exhaust Gasket	\$4.65	18314-K56-701
					EX005031F	Exhaust Gasket	\$4.65	18339-K56-701
					IR003018AFM	Intake Gasket Reed to Carb Boot	\$3.80	14132-K56-701
					Component Part# C7491	Component Description Clutch Cover Gasket	List Price \$12.78	OEM Part # 91311-KS6-700
			Crank Seal Kit C7654	List Price \$17.04	Kit Components OS103	Component Description 20X32X7 Left Side Crank Seal	List Price \$9.47	OEM Part# 91205-166-004
					OS105	30X45X8 Right Side Crank Seal	\$9.47	91203-KS6-004
CR125	88-89	56 mm	Top End Kit C7008	List Price \$35.72	Component Part# H0355010S	Component Description Head Gasket 56mm Bore	List Price \$17.38	OEM Part # 12251-KZ4-701
					B0008020F	Base Gasket	\$5.34	12191-KS6-701
					EX004042AM	Exhaust Gasket	\$4.65	18314-K56-701
					EX005031F	Exhaust Gasket	\$4.65	18339-K56-701
					IR003018AFM	Int. Gasket Reed to Carb Boot	\$3.80	14132-K56-701
					Component Part# C7491	Component Description Clutch Cover Gasket	List Price \$12.78	OEM Part # 91311-KS6-700
			Crank Seal Kit C7654	List Price \$17.04	Kit Components OS103	Component Description 20X32X7 Left Side Crank Seal	List Price \$9.47	OEM Part# 91205-166-004
					OS105	30X45X8 Right Side Crank Seal	\$9.47	91203-KS6-004
CR125	90-91	55 mm	Top End Kit C7010	List Price \$35.72	Component Part# H0225010S	Component Description Head Gasket 55mm Bore	List Price \$17.38	OEM Part # 12251-KZ4-701
					B0009018AFM	Base Gasket	\$5.34	12191-KZ4-860
					EX006042AM	Exhaust Gasket	\$4.65	18291-KZ4-700
					IR003018AFM	Int. Gasket Reed to Carb Boot	\$3.80	14132-K56-701
					PV001018AFM	Right Power Valve Cover Gasket	\$3.80	12108-KZ4-700
					PV002018AFM	Left Power Valve Cover Gasket	\$3.80	12109-KZ4-700
					PV003018AFM	Upper Power Valve Cover Gasket	\$3.80	12112-KZ4-700
CR125	92-97	55 mm	Top End Kit C7115	List Price \$35.72	Component Part# H0225010S	Component Description Head Gasket 55mm Bore	List Price \$17.38	OEM Part # 12251-KZ4-701
		56 mm	C7306	\$35.72	H0355010S	Head Gasket 56mm Bore	\$17.38	12251-KZ4-701
		58 mm	C7299	\$35.72	H0409010S	Head Gasket 58mm Bore	\$17.38	12251-KZ4-701
					B0009018AFM	Base Gasket	\$5.34	12191-KZ4-860
					B0009012F	High Compression Base Gasket	\$9.32	12191-KZ4-860
					EX006042AM	Exhaust Gasket	\$4.65	18291-KZ4-700
					IR003018AFM	Int. Gasket Reed to Carb Boot	\$3.80	14132-K56-701
					PV001018AFM	Right Power Valve Cover Gasket	\$3.80	12108-KZ4-700
					PV002018AFM	Left Power Valve Cover Gasket	\$3.80	12109-KZ4-700
					PV003018AFM	Upper Power Valve Cover Gasket	\$3.80	12112-KZ4-700

See Pg.43 for Bottom End Kit

See Pg.39 for Bottom End Kit



# MX/Dirt • Off-Road Gaskets



Cometic Gasket - An Exclusive NASCAR Performance® Product

## HONDA 125

Model	Year	Bore Size	Top End Kit	List Price	Component Part#	Component Description	List Price	OEM Part #						
CR125	98-99	55 mm	C7394	\$35.74	H0225010S	Head Gasket 55mm Bore	\$17.38	12251-KZ4-701						
			C7406	\$35.74	H0355010S	Head Gasket 56mm Bore	\$17.38	12251-KZ4-701						
			C7407	\$35.74	H0409010S	Head Gasket 58mm Bore	\$17.38	12251-KZ4-701						
						B0314018AFM	Base Gasket	\$5.34	12191-KZ4-J00					
						B0314012F	High compression Base Gasket	\$9.32						
						IR003018AFM	Int. Gasket Reed to Carb Boot	\$3.80	14132-K56-701					
						EX006042AM	Exhaust Gasket	\$4.65	18291-KZ4-700					
						PV001018AFM	Right Power Valve Cover Gasket	\$3.80	12108-KZ4-700					
						PV002018AFM	Left Power Valve Cover Gasket	\$3.80	12109-KZ4-700					
						PV003018AFM	Upper Power Valve Cover Gasket	\$3.80	12112-KZ4-700					
CR125	00	54 mm	C7678	\$42.13	H0928010S	Head Gasket 54mm Bore	\$17.38	12251-KZ4-A91						
			C7694	\$42.13	H0929010S	Head Gasket 56mm Bore	\$17.38	12251-KZ4-A91						
			C7695	\$42.13	H0930010S	Head Gasket 58mm Bore	\$17.38	12251-KZ4-A91						
						B0314018AFM	Base Gasket	\$5.34	12191-KZ4-J00					
						B0314012F	High compression Base Gasket	\$9.32	12191-KZ4-J00					
						B0314010S	High compression Base Gasket	\$9.32						
						IR003018AFM	Intake Gasket Reed to Carb Boot	\$3.80	14132-K56-701					
						EX006042AM	Exhaust Gasket	\$4.65	18291-KZ4-700					
						PV091032AFM	Right Power Valve Cover Gasket	\$5.34	12108-KZ4-A90					
		CR125	01-02	54 mm	C7757	\$38.33	H0928010S	Head Gasket 54mm Bore	\$17.38	12251-KZ4-A91				
C7758	\$38.33				B0490018AFM	Base Gasket	\$7.38	12191-KZ4-L10						
C7759	\$38.33				B0490012F	High Compression Base Gasket	\$8.75	12191-KZ4-L10						
						EX006042AM	Exhaust Gasket	\$4.65	18291-KZ4-700					
						IR003018AFM	Intake Gasket Reed to Carb Boot	\$3.80	14132-K56-701					
						PV091032AFM	Right Power Valve Cover Gasket	\$5.34	12108-KZ4-A90					
						R124S	Expansion Cham O-rings 2 Req.	\$3.74						
						R19X3V	Water Outlet O-ring	\$3.02	91312-KE7-003					
CR125	90-02			Bottom End Kit w/Oil Seals	C7010BE	\$66.70	EC083032AFM	Inner Clutch Cover	\$6.71	11394-KZ4-A90				
								EC185020F	Center Case Gasket	\$16.13	11191-KZ4-620			
						IR003018AFM	Intake Gasket	\$3.80	14132-KY4-970					
						R16X3V	Fill Plug O-ring	\$1.26	91303-800-000					
						R20X2V	Output Shaft O-ring	\$3.02	91351-KA3-711					
						WA117	Drain Plug Gasket	\$0.95	94109-12000					
						WA133	Water Pump Drain Plug Gasket	\$0.90	90543-273-000					
						WP033018AFM	Water Pump Gasket 2 req	\$4.94	19229-KZ4-620					
		Oil Seal Kit	C7010OS		List Price	\$36.50	Component Part#	Component Description	List Price	OEM Part #				
											OS103	Left Crank Seal	\$9.47	91205-166-004
											OS105	Right Crank Seal	\$9.47	91203-KS6-004
											OS227	Water Pump Shaft Seal	\$2.67	91201-965-000
											OS236	Shift Shaft Seal	\$4.23	91203-KK3-830
											OS242	Outer Water Pump Shaft Seal	\$2.67	91211-KA3-761
											OS243	Start Shaft Seal	\$1.96	91205-KA3-712
				OS244							Clutch Pushrod Seal	\$1.29	91206-VA3-J02	
				OS363							Output Shaft Seal	\$4.74	91201-KS6-004	
				Clutch & Mag Kit							C7010CM	List Price	\$17.61	Component Part#
		EC228	Clutch Cover Gasket		\$11.36	91311-KS6-700								
		EC510060AFM	Mag Cover Gasket		\$6.25	11352-KS6-700								

All Component Parts can be purchased individually.

**WARNING:** Cancer and Reproductive Harm [www.P65Warnings.ca.gov](http://www.P65Warnings.ca.gov)



# MX/Dirt • Off-Road Gaskets



Cometic Gasket - An Exclusive NASCAR Performance® Product

## HONDA 125

Model	Year	Bore Size	Top End Kit	List Price	Component Part#	Component Description	List Price	OEM Part #	
CR125	03-04	54 mm	C7181	\$42.19	H1712010S	Head Gasket 54mm Bore	\$17.38	12251-KZ4-A91	
		56 mm	C7184	\$42.19	H0929010S	Head Gasket 56mm Bore	\$17.38	12251-KZ4-A91	
		57 mm	C3220	\$42.19	H0929SP2010S	Head Gasket 57mm Bore	\$17.38	12251-KZ4-A91	
						B0628018AFM	Base Gasket	\$7.38	12191-KZ4-L30
						B0628012F	High Compression Base Gasket	\$7.38	
						EX006042AM	Exhaust Gasket	\$4.65	18291-KZ4-700
						IR394032AFM	Intake Gasket	\$3.80	14132-KZ4-L30
						PV091032AFM	Rt. Power Valve Cover Gasket 03	\$5.34	12108-KZ4-A90
						PV110018AFM	Left Power Valve Cover Gasket	\$6.19	12111-KZ3-L20
						PV127032AFM	Rt. Power Valve Cover Gasket 04	\$6.76	12108-KSR-A00
						R124S	Exp. Chamber O-rings 2 Req.	\$3.74	
						R19X3V	Water Outlet O-ring	\$3.02	91312-KE7-003
	<b>Bottom End Kit w/Oil Seals</b>				<b>List Price</b>	<b>Component Part#</b>	<b>Component Description</b>	<b>List Price</b>	<b>OEM Part #</b>
			C7181BE	\$66.70	EC709020F	Center Case Gasket	\$16.13	11191-KZ4-L30	
					WA117	Oil Drain Plug Gasket	\$0.95	94109-12000	
					EC083032AFM	Inner Clutch Cover Gasket	\$6.71	11394-KZ4-A90	
					R18X3V	Fill Plug O-ring	\$1.71	91307-035-000	
					WP033018AFM	Water Pump Cover Gasket	\$4.94	19229-KZ4-620	
					WA128	Case Cover Drain Plug Crush Washer	\$1.59	90463-ML7-000	
<b>Oil Seal Kit</b>				<b>List Price</b>	<b>Component Part#</b>	<b>Component Description</b>	<b>List Price</b>	<b>OEM Part #</b>	
			C7181OS	\$34.57	OS105	Right Crank Seal	\$9.47	91203-KS6-004	
					OS227	Water Pump Shaft Seal	\$2.67	91201-965-000	
					OS236	Shift Shaft Seal	\$4.23	91203-KK3-830	
					OS241	Output Shaft Seal	\$2.67	91201-KSR-A01	
					OS242	Impeller Seal	\$2.67	91211-KA3-761	
					OS243	Start Shaft Seal	\$1.96	91205-KA3-712	
					OS244	Clutch Pushrod Seal	\$1.43	91206-VA3-J02	
<b>Clutch &amp; Mag Kit</b>				<b>List Price</b>	<b>Component Part#</b>	<b>Component Description</b>	<b>List Price</b>	<b>OEM Part #</b>	
			C7181CM	\$17.61	EC228	Outer Clutch Cover O-ring	\$11.36	91311-KS6-700	
					EC510060AFM	Mag Cover Gasket	\$6.25	11352-KZ4-L10	
CR125	05-07	54 mm	C3085	\$42.19	H2370010S	Head Gasket 54mm Bore	\$10.68	12251-KSR-731	
		56 mm	C3088	\$42.19	H2370SP1010S	Head Gasket 56mm Bore	\$10.68	12251-KSR-731	
		57 mm	C3221	\$42.19	H2370SP5010S	Head Gasket 57mm Bore	\$10.68	12251-KSR-731	
		58 mm	C3537	\$42.19	H2370SP4010S	Head Gasket 58mm Bore	\$10.68	12251-KSR-731	
							B0812014RC	Base Gasket	\$8.98
						B0812010RC	Base Gasket High Compression	\$10.17	12191-KSR-731
						EX644010S	Exhaust Gasket	\$4.72	18291-KSR-730
						PV091032AFM	Right Power Valve Cover Gasket	\$5.34	12108-KZ4-A90
						PV132018AFM	Left Power Valve Cover Gasket	\$4.72	12111-KSR-730
	<b>Bottom End Kit w/Oil Seals</b>				<b>List Price</b>	<b>Component Part#</b>	<b>Component Description</b>	<b>List Price</b>	<b>OEM Part #</b>
				C3085BE	\$66.70	EC1013020F	Center Case Gasket	\$20.22	11191-KSR-730
						EC1014032AFM	Inner Clutch cover O-ring	\$20.22	11394-KSR-730
						IR539032AFM	Intake Gasket	\$5.91	14132-KSR-731
						MR039	Center Case Coolant Passage O-Ring	\$4.20	91301-KSR-731
						R18X3V	Fill Plug O-ring	\$1.71	91307-035-000
						R20X2V	Power Valve Shaft O-ring	\$3.02	91353-KM1-004
						WA128	Case Cover Drain Plug Crush Washer	\$1.59	90463-ML7-000
						WA137	Oil Drain Plug Gasket	\$1.53	94109-12000
						WP395018AFM	Water Pump Cover Gasket	\$5.91	19229-KSR-730
	<b>Oil Seal Kit</b>				<b>List Price</b>	<b>Component Part#</b>	<b>Component Description</b>	<b>List Price</b>	<b>OEM Part #</b>
				C7181OS	\$34.57	OS105	Right Crank Seal	\$9.47	91203-KS6-004
						OS227	Water Pump Shaft Seal	\$2.67	91201-965-000
						OS236	Shift Shaft Seal	\$4.23	91203-KK3-830
					OS241	Output Shaft Seal	\$2.67	91201-KSR-A01	
					OS242	Impeller Seal	\$2.67	91211-KA3-761	
					OS243	Start Shaft Seal	\$1.96	91205-KA3-712	
					OS244	Clutch Pushrod Seal	\$1.43	91206-VA3-J02	
<b>Clutch &amp; Mag Kit</b>				<b>List Price</b>	<b>Component Part#</b>	<b>Component Description</b>	<b>List Price</b>	<b>OEM Part #</b>	
			C7181CM	\$17.61	EC228	Outer Clutch Cover O-ring	\$11.36	91311-KS6-700	
					EC510060AFM	Mag Cover Gasket	\$6.25	11352-KZ4-L10	

All Component Parts can be purchased individually.



**WARNING:** Cancer and Reproductive Harm [www.P65Warnings.ca.gov](http://www.P65Warnings.ca.gov)



# MX/Dirt · Off-Road Gaskets



Cometic Gasket - An Exclusive NASCAR Performance® Product

## HONDA CRF150F

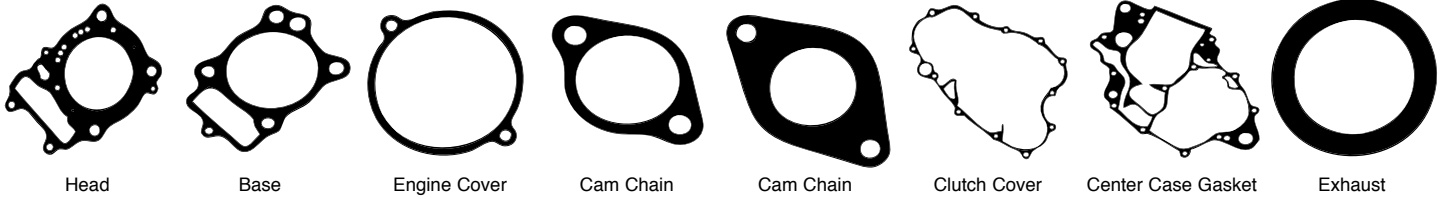

Model	Year	Bore Size	EST Top End Kit	List Price	Component Part#	Component Description	List Price	OEM Part #	
CRF150F	03-05	64.5 mm	C3131-EST	\$71.49	H2490010S	Head Gasket 64.5mm	\$13.74	12251-KBB-901	
			C3161-EST	\$71.49	H2490SP1010S	Head Gasket 67mm	\$13.74		
						3231V	Valve Stem Seals 2 req.	\$6.48 ea.	12208-413-003
						B0845020F	Base Gasket	\$7.10	12191-KCN-000
						EC1079018AFM	Cam Chain Tensioner	\$2.16	16214-KPS-900
						EC681018AFM	Left Cylinder Head Cover	\$5.34	12339-KTO-710
						R10X2V	Valve Guide O-rings 2 Req.	\$1.59	91301-KW1-900
						R126V	Intake Gasket	\$1.19	91304-HB3-003
						R151V	Cam Cover O-ring	\$2.29	12339-KTO-710
						R35X3V	Valve Adjuster Cap O-rings 2 Req.	\$3.64	91303-KK3-830
CRF150F	06-14	58mm	C3499-EST	\$33.89	H2504010S	Head Gasket 58mm	\$13.74	12251-KRM-B41	
			C3500-EST	\$33.89	H2504SP6010S	Head Gasket 62mm	\$13.74		
						3234V	Valve Stem Seals 2 req.	\$5.50 ea.	12209-GB4-681
						B0859020F	Base Gasket	\$7.10	12191-KWK-900
						EC1124018AFM	Cam Chain Tensioner	\$2.16	14560-KRM-840
						EX691064AM	Exhaust Gasket	\$4.20	18291-MN5-650
						R126V	Intake Gasket	\$1.19	91304-KRM-840

Model	Year	Bore Size	EST Top End Kit	List Price	Component Part#	Component Description	List Price	OEM Part #
CRF150R, RB	07-16	66 mm	C3187-EST	\$51.95	H2612SP1018S	Head Gasket 66mm Bore	\$27.44	12251-KSE-671
		68 mm	C3171-EST	\$51.95	H2612018S	Head Gasket 68mm Bore	\$27.44	12251-KSE-671
					3239V	Valve Stem Seal 4 Req.	\$5.50 ea.	12208-ML0-721
					B0880014RC	Base Gasket	\$11.87	12191-KSE-671
					EC960018AFM	Cam Chain Tensioner Gasket	\$3.35	14560-MEN-671
					EX784080C	Exhaust Gasket	\$3.35	18291-KZ1-670

Bottom End Kit w/Oil Seals	List Price	Component Part#	Component Description	List Price	OEM Part #
C3187BE	\$84.38	EC1157020RC	Center Case Gasket	\$10.42	11191-KSE-670
		WP205	Water Pump Gasket	\$3.32	19226-KSE-670
		R18X3V	Fill Plug O-ring	\$1.63	91307-035-000
		R27X2V	Crank Plug O-ring	\$1.92	91305-KF0-003
		R113B	Water Pump Inlet Gasket	\$2.37	91303-377-000
		WA118	Water Pump Drain Washer	\$1.74	90463-ML7-000
		R113B	Dip Stick O-ring	\$1.05	91311-PH7-003
		R40X2V	Oil filter O-ring	\$2.09	91302-PA9-003
		R18X3V	Timing Plug O-ring	\$1.45	91307-035-003
		R8.5X1.5V	Oil Filter Galley O-ring	\$1.50	90751-GK1-003
<b>Oil Seal Kit</b>	<b>List Price</b>	<b>Component Part#</b>	<b>Component Description</b>	<b>List Price</b>	<b>OEM Part #</b>
C3187OS	\$39.88	OS227	Water Pump Seal 12X22X5	\$2.67	91201-148-003
		OS236	Shift Shaft Seal 14X22X5	\$4.23	91203-KA4-771
		OS239	Start Shaft Seal 20X28X5	\$2.60	91204-KF0-003
		OS262	Crank End Oil Seal 10X21X5	\$2.60	91204-KRN-671
		OS264	Left Crank Seal 38X52X7	\$10.97	91201-MEB-671
		OS285	Output Shaft Seal 20X30X7	\$1.48	91202-KCY-761
		OS303	Right Crank Seal 32X48X7.5	\$10.71	91201-KSE-671
		OS304	Oil Pump Seal 18X30X5	\$4.62	91203-KSE-671
<b>Clutch &amp; Mag Kit</b>	<b>List Price</b>	<b>Component Part#</b>	<b>Component Description</b>	<b>List Price</b>	<b>OEM Part #</b>
C3187CM	\$32.09	EC1156032AFM	Clutch Cover Gasket	\$20.22	11394-KSE-670
		EC1155032AFM	Mag Cover Gasket	\$11.87	11395-KSE-670

All Component Parts can be purchased individually.

**WARNING:** Cancer and Reproductive Harm www.P65Warnings.ca.gov





# MX/Dirt • Off-Road Gaskets



Cometic Gasket - An Exclusive NASCAR Performance® Product

## HONDA XL200R/CRF230F

Model	Year	Bore Size	Top End Kit	List Price	Component Part#	Component Description	List Price	OEM Part #
XL200R	83-84	67 mm	C7234	\$26.80	H0334043F	Head Gasket 67mm	\$18.56	12251-KT0-P00
XR200R	80-83				B0021020F	Base Gasket	\$5.34	12191-KT0-710
XR200	84-85	69 mm	C7235	\$26.80	H0333043F	Head Gasket 69mm	\$18.56	12251-KT0-P00
					B0392020F	Base Gasket	\$5.34	12191-KZ1-920
XR200R	86-91	67 mm	C7236	\$26.80	H0334043F	Head Gasket 67mm	\$18.56	12251-KT0-P00
					B0021020F	Base Gasket	\$5.34	12191-KT0-710
XR200R	92-03	67 mm	C7237	\$26.80	H0334043F	Head Gasket 67mm	\$18.56	12251-KT0-P00
					B0021020F	Base Gasket	\$5.34	12191-KT0-710
CRF230F	03-16	66 mm 68 mm	C3132-EST C3283-EST	\$71.49 \$71.49	H2469040S	Head Gasket 66mm	\$16.69	12251-KT0-711
					3231V	Valve Stem Seals 2 req.	\$6.48 ea.	12208-413-003
					B0021020F	Base Gasket	\$5.34	12191-KT0-710
					EC1079018AFM	Cam Chain Tensioner	\$2.16	16214-KPS-900
					EC681018AFM	Left Cylinder Head Cover	\$5.34	12339-KTO-710
					EX691064AM	Exhaust Gasket	\$4.20	18291-MN5-650
					R10X2V	Valve Guide O-rings 2 Req	\$1.59	91301-KW1-900
					R126V	Intake Gasket	\$1.19	91304-HB3-003
					R151V	Cam Cover O-ring	\$2.29	12339-KTO-710
					R35X3V	Valve Adjuster Cap O-rings 2 Req.	\$3.64	91303-KK3-830
						<b>Component Part#</b>	<b>List Price</b>	<b>OEM Part #</b>
					EC1076018AFM	Clutch Cover	\$11.93	11393-KGA-900

## HONDA MR250

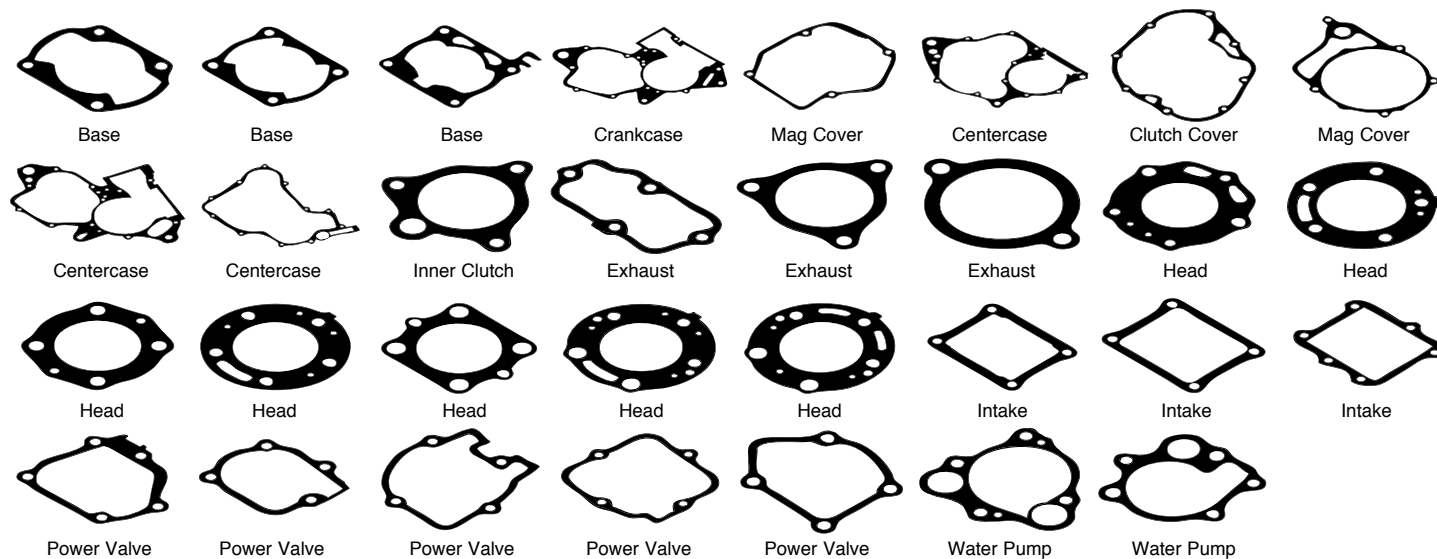

Model	Year	Bore Size	Top End Kit	List Price	Component Part#	Component Description	List Price	OEM Part #
MR250, MT250,	73-77	72 mm	C7140	\$25.55	H0182043F	Head Gasket 72mm	\$19.28	12251-358-306
					B0137020F	Base Gasket 73-76	\$6.25	12191-357-306
					B0395020F	Base Gasket 77-84	\$5.34	12191-381-306
CR250	73-74	71 mm	C7811	\$25.55	H0912020C	Head Gasket 71mm	\$14.20	12251-357-020
					B0137020F	Base Gasket	\$6.25	12191-357-306
					EX250020C	Exhaust Gasket	\$9.99	18359-357-000
					IR133031F	Intake Gasket	\$3.80	16229-357-010
			<b>Bottom End Kit w/o crank seals</b>	<b>List Price</b>	<b>Component Part#</b>	<b>Component Description</b>	<b>List Price</b>	<b>OEM Part #</b>
			C3321	\$30.11	EC357031F	Center Case Gasket	\$11.81	11191-357-030
					EC358031F	Clutch Cover Gasket	\$18.56	11394-357-040/306
					EC394020F	Mag Cover Gasket	\$6.25	11395-357-020



# MX/Dirt • Off-Road Gaskets



Cometic Gasket - An Exclusive NASCAR Performance® Product

## HONDA CR250

Model	Year	Bore Size	Top End Kit	List Price	Component Part#	Component Description	List Price	OEM Part #								
CR250	78-80	71 mm	Top End Kit C7278	\$34.47	H0359020C	Head Gasket 71mm	\$14.20	12254-430-000								
					B0210020F	Base Gasket	\$6.25	12191-430-306								
					EX293SP1042AM	Exhaust Gasket	\$9.94	18291-430-000								
					IR004018AFM	Intake Gasket	\$3.80	14132-KAE-000								
					IR005018AFM	Intake Gasket	\$3.80	14133-430-000								
			Bottom End Kit w/o crank seals C3322	\$31.15	EC465031F	Inner Clutch Cover	\$14.93									
					EC486020F	Center Case Gasket	\$13.17	11191-430-010								
					EC487020F	Mag Cover Gasket	\$9.94	11395-430-306								
CR250	81-82	68 mm	Top End Kit C7011	\$25.55	H0007043F	Head Gasket	\$17.38	12254-KA4-004/306								
					B0010020F	Base Gasket	\$6.25	12191-KA4-306								
					IR004018AFM	Intake Gasket	\$3.80	14132-KAE-000								
					IR005018AFM	Intake Gasket	\$3.80	14133-430-000								
					Bottom End Kit w/o crank seals C3323	\$50.99	EC801032AFM	Clutch Cover Gasket	\$14.93	31129-KA4-000/ 11395-KA4-000/306						
			EC802020F	Center Case Gasket			\$13.17	11191-KA4-000								
			EC803060AFM	Mag Cover Gasket			\$9.94	11395-KA4-710								
			EX397042AM	Exhaust Gasket			\$4.65	18291-430-000/306								
			WP157032AFM	Water Pump Gasket			\$4.72	19229-KA4-307								
			CR250	83	68 mm	Top End Kit C7108	\$25.55	H0008043F	Head Gasket	\$19.82	12254-KA4-710					
B0010020F	Base Gasket	\$6.25						12191-KA4-306								
EC801032AFM	Clutch Cover Gasket	\$14.93						31129-KA4-000/ 11395-KA4-000/306								
Crank Seal Kit C7697	\$18.15	OS103						Left Side Crank Seal 20X32X7	\$9.47	91205-166-004						
		OS106						Right Crank Seal 38X58X11	\$10.68	91201-KA4-004						
CR250	84	68 mm				Top End Kit C7012	\$25.55	H0008043F	Head Gasket	\$19.82	12254-KA4-710					
								B0011020F	Base Gasket	\$6.25	12191-KA4-307					
								C7490	Clutch Cover Gasket	\$11.47	91311-KS7-701					
								CR250	85	68 mm	Top End Kit C7013	\$35.72	H0009043F	Head Gasket	\$19.82	12254-KS7-881
													B0012020F	Base Gasket	\$6.25	12191-KS7-306
CR250	85-86	68 mm	Top End Kit C7013	\$35.72	EX007042AM	Exhaust Gasket	\$4.65	18291-KA4-770								
					IR004018AFM	Intake Gasket	\$3.80	14132-430-000								
					IR005018AFM	Intake Gasket	\$3.80	14133-430-000								
					Bottom End Kit C7013BE	\$65.99	EC846020F	Center Case Gasket	\$13.17	11191-KA4-770						
							WA137	Drain Plug Gasket	\$1.53	94109-12000						
			R12X2V	Fill Plug O-ring 11.9x2.2			\$1.19	91370-461-000								
			Oil Seal Kit C7013OS	\$37.12	WA133	Clutch Cover Drain Plug	\$0.90	90543-273-000								
					OS103	Left Crank Seal 20x32x7	\$9.47	91205-166-004								
					OS106	Right Crank Seal 38x58x11	\$10.68	91201-KA4-004/ 91201-ML3-003								
					OS236	Shift Shaft Seal 14x22x5	\$4.23	91203-KA4-771/ 91203-KA4-772								
OS240	Clutch Lifter Oil Seal 12x18x3	\$2.43			91201-951-003											
Clutch & Mag Kit C7013CM	\$18.34	OS443	Output Shaft Seal 28x40x8	\$7.71	91207-ML3-003											
		OS239	Start Shaft Seal 20x28x5	\$2.6	91202-KA4-003/ 91204-KF0-003											
		EC082063N	Mag Cover Gasket	\$4.09	11352-KA4-770/ 11352-KA4-771											
		EC041032AFM	Clutch Cover Gasket	\$14.25	11395-KS7-000/ 11395-KS7-306											

All Component Parts can be purchased individually.



**WARNING:** Cancer and Reproductive Harm www.P65Warnings.ca.gov



# MX/Dirt • Off-Road Gaskets



Cometic Gasket - An Exclusive NASCAR Performance® Product

## HONDA CR250

Model	Year	Bore Size	Top End Kit	List Price	Component Part#	Component Description	List Price	OEM Part #
CR250	86-91	68 mm	C7015	\$38.33	H0009043F	Head Gasket	\$19.82	12254-KS7-881
					B0013020F	Base Gasket	\$6.25	12191-KS7-306
					B0013012F	High Comp. Base Gasket .012"	\$9.32	
					EX008042AM	Exhaust Gasket	\$4.65	18291-KS7-000
					IR004018AFM	Intake Gasket Cylinder to Reed	\$3.80	14132-430-000
					IR020020F	Intake Gasket Reed to Carb	\$3.80	14133-KS7-000
					PV004018AFM	Side Power Valve Gasket	\$3.80	12108-KS7-000
					PV005020F	Upper Left Power Valve Gasket	\$3.80	12113-KS7-000
					PV006020F	Upper Right Power Valve Gasket	\$3.80	12114-KS7-000
					<b>Component Part#</b>	<b>Component Description</b>	<b>List Price</b>	<b>OEM Part #</b>
					C7490	Clutch Cover Gasket	\$11.47	91311-KS7-701
					<b>Component Part#</b>	<b>Component Description</b>	<b>List Price</b>	<b>OEM Part #</b>
					OS103	Left Side Crank Seal 20X32X7	\$9.47	91205-166-004
					OS106	Right Crank Seal 38X58X11	\$10.68	91201-KA4-004
					<b>Top End Kit</b>	<b>List Price</b>	<b>Component Part#</b>	<b>Component Description</b>
C7116	\$38.33	H0247010S	Head Gasket	\$28.51	12254-KZ3-860			
		B0014018AFM	Base Gasket	\$6.25	12191-KZ3-880			
		IR004018AFM	Intake Gasket	\$3.80	14132-430-000			
		PV007018AFM	Right Side Power Valve Gasket	\$3.80	12108-KZ3-880			
		R221V	Exhaust O-rings 2 Req.	\$3.92	91304-KZ3-890			
<b>Bottom End Kit w/Oil Seals</b>	<b>List Price</b>	<b>Component Part#</b>	<b>Component Description</b>	<b>List Price</b>	<b>OEM Part #</b>			
C7116BE	\$66.70	MR129	Case Water Galley O-ring	\$4.20	91301-KZ3-861			
		EC187020F	Crank Case Gasket	\$18.56	11191-KZ3-J20			
		WA137	Drain Plug Gasket	\$1.53	94109-12000			
		R18X3V	Fill Plug O-ring	\$1.71	91307-035-000			
		WA128	Clutch Drain Washer	\$1.59	90463-ML7-000			
		WP034018AFM	Water Pump Gasket	\$5.00	19229-KZ3-880			
		EC084032AFM	Inner Clutch Cover Gasket	\$9.32	11395-KZ3-880			
<b>Oil Seal Kit</b>	<b>List Price</b>	<b>Component Part#</b>	<b>Component Description</b>	<b>List Price</b>	<b>OEM Part #</b>			
C7116OS	\$36.74	OS107	Left Crank Seal	\$8.29	91205-KZ3-861			
		OS106	Right Crank Seal	\$10.68	91201-KA4-004			
		OS227	Water Pump Shaft Seal	\$2.67	91201-965-000			
		OS236	Shift Shaft Seal	\$4.23	91203-KA4-772			
					91203-KK3-830			
					91203-KA4-771			
		OS238	Output Shaft Seal	\$3.17	91207-ML3-871			
		OS239	Start Shaft Seal	\$2.60	91204-KF0-003			
		OS240	Clutch Pushrod Seal	\$2.43	91201-951-003			
		OS242	Impeller Shaft Seal	\$2.67	91211-KA3-761			
<b>Clutch &amp; Mag Kit</b>	<b>List Price</b>	<b>Component Part#</b>	<b>Component Description</b>	<b>List Price</b>	<b>OEM Part #</b>			
C7116CM	\$14.77	EC196	Outer Clutch O-ring	\$10.68	91311-KS7-701			
		EC082063N	Mag Cover Gasket	\$4.09	11352-KA4-771			
CR250	02-04	66.5 mm	C7191	\$44.29	H1288SP1010S	66.5mm Bore Head Gasket	\$28.51	14132-KZ3-L20
		68.5 mm	C7197	\$44.29	H1288010S	68.5mm Bore Head Gasket	\$28.51	12254-KSK-731
					B0546018AFM	Base Gasket .018"	\$6.25	12191-KZ3-L20
					B0546012F	High Comp. Base Gasket .012"	\$9.32	
					IR232018AFM	Intake Gasket	\$3.80	18291-KZ3-L20
					EX456010S	Exhaust Gasket	\$5.00	12111-KZ3-L20
					PV110018AFM	Power Valve Gasket	\$6.19	12254-KSK-731
<b>Bottom End Kit w/Oil Seals</b>	<b>List Price</b>	<b>Component Part#</b>	<b>Component Description</b>	<b>List Price</b>	<b>OEM Part #</b>			
C7191BE	\$66.70	EC5910322AFM	Inner Clutch Cover Gasket	\$13.62	11395-KZ3-L20			
		EC592020F	Center Case Gasket	\$14.87	11191-KSK-670			
		IR232018AFM	Intake Gasket	\$3.80	14132-KZ3-L20			
		MR037	Center Case O-ring	\$3.69	91301-KZ3-L20			
		R18X3V	Fill Plug O-ring	\$1.71	91307-035-000			
		WA128	Case Drain Washer 2 Required	\$1.59	90463-ML7-000			
		WA137	Drain Plug Gasket	\$1.53	94109-12000			
		WP131018AFM	Water Pump Gasket 2 Required	\$5.91	19229-KZ3-L20			
<b>Oil Seal Kit</b>	<b>List Price</b>	<b>Component Part#</b>	<b>Component Description</b>	<b>List Price</b>	<b>OEM Part #</b>			
C7191OS	\$36.74	OS107	Left Crank Seal 20x37x7	\$8.29	91205-KZ3-861			
		OS227	Water Pump Shaft Seal 12x22x5	\$2.67	91201-965-000			
		OS236	Shift Shaft Seal 14x22x5	\$4.23	91203-KA4-771			
		OS238	Output Shaft Seal 31x40x7	\$3.17	91207-ML3-871			
		OS239	Start Shaft Seal 20x28x5	\$2.60	91204-KF0-003			

All Component Parts can be purchased individually.



**WARNING:** Cancer and Reproductive Harm [www.P65Warnings.ca.gov](http://www.P65Warnings.ca.gov)



# MX/Dirt - Off-Road Gaskets



Cometic Gasket - An Exclusive NASCAR Performance® Product

## HONDA CR250

Model	Year	Bore Size	Top End Kit	List Price	Component Part#	Component Description	List Price	OEM Part #
CR250	05-07	66.5 mm	C3089	\$44.29	H2368010S	Head Gasket	\$12.99	12254-KSK-731
		68.5 mm	C3092	\$44.29	H2388010S	Head Gasket 68.5mm Bore	\$12.99	
					B0811014RC	Base Gasket	\$10.17	12191-KSK-731
					PV110018AFM	Power Valve gasket	\$6.19	12111-KZ3-L20
					R14X2.5V	Exh. Valve Cover O-rings 4 req.	\$1.13	91302-KSK-731
					R43X3V	Exp. Chamber O-rings 2 req.	\$3.71	91304-KZ3-890
					WA139	Head Washer 2 Req.	\$1.83	90442-028-000
					EX456010S	Exhaust Manifold Gasket	\$5.00	18291-KZ3-L20
					IR232032AFM	Intake Gasket	\$3.80	14132-KZ3-L20
			<b>Bottom End Kit w/crank seals</b>	<b>List Price</b>	<b>Component Part#</b>	<b>Component Description</b>	<b>List Price</b>	<b>OEM Part #</b>
			C3325	\$48.87	EC592020F	Centercase Gasket	\$14.87	11191-KSK-730
					EC590032AFM	Mag Cover Gasket	\$13.62	11352-KZ3-L20
					EC591032AFM	Inner Clutch Cover Gasket	\$13.62	11395-K23-L20
			<b>EST Top End Kit</b>	<b>List Price</b>	<b>Component Part#</b>	<b>Component Description</b>	<b>List Price</b>	<b>OEM Part #</b>
CRF250R,	04-09	78 mm	C3133-EST	\$69.63	H2334027S	Head Gasket 78mm Bore	\$22.83	12251-KRN-671/731
CRF250X	04-13	79 mm	C7185-EST	\$69.63	H2145027S	Head Gasket 79mm Bore	\$22.83	12251-KRN-671/731
		81 mm	C7189-EST	\$69.63	H2069027S	Head Gasket 81mm Bore	\$22.83	
		82 mm	C3232-EST	\$69.63	3234V	Int. & Exh. Valve Seals 04-07 4 Req.	\$5.50 ea.	12209-GB4-681
					B0694014RC	Base Gasket .014	\$13.47	12191-KRN-731
					EC960018AFM	Cam Chain Tensioner Gasket	\$3.35	14560-MEN-671
					EX169064AM	Exhaust Gasket	\$1.93	18291-MM5-860
					MA0164	Cam Chain Tensioner Bolt Seal	\$0.93	90442-397-000
					R14X2.5V	Head Oil Drain Cap O-ring	\$1.13	91303-377-000
					R19X3V	Water Outlet O-ring	\$3.02	91312-KE7-003
					3239V	Exh. Valve Seals 08-09 2 Req.	\$5.50 ea.	12208-ML0-721
					WA110	Air Recirculation Valve Seal	\$0.80	90452-323-000
					<b>Component Part#</b>	<b>Component Description</b>	<b>List Price</b>	<b>OEM Part #</b>
					C3069	Valve Cover Gasket	\$13.46	12391-KRN-670

CRF250R, 04-09

Bottom End Kit w/Oil Seals	List Price	Component Part#	Component Description	List Price	OEM Part #
C7185BE	\$115.59	WP170	Molded Rubber Water Pump	\$16.99	19226-KRN-670
		WA111	Water Pump Imp. Seals 2 Req.	\$0.80	90447-KE1-000
		WA128	Coolant Drain Bolt Washer	\$1.59	90463-ML7-000*
		WA128	Coolant Drain Bolt Washer	\$1.59	90463-ML7-000*
		EC959032AFM	Inner Clutch Cover Gasket	\$14.93	11394-KRN-670
		R16X2.5V	Water Passage Collar O-ring	\$1.26	91304-MJ0-003
		R27x2V	Clutch Cover Cap O-ring	\$1.86	91305-KF0-003
		R12X2V	Trans Oil Fill Cap O-ring	\$4.09	91370-461-000*
		R18X3V	Crank Dipstick O-ring	\$1.71	91307-035-000
		R8.5X2V	Oil Filter Relief Valve O-ring	\$1.10	90751-GK1-003
		R40X2V	Oil Filter Cover O-ring	\$2.82	91302-PA9-003
		R14X2.5V	Mag Side Cap O-ring	\$1.13	91303-377-000
		EC958020F	Case Gasket	\$11.93	111910-KRN-670
<b>Oil Seal Kit</b>	<b>List Price</b>	<b>Component Part#</b>	<b>Component Description</b>	<b>List Price</b>	<b>OEM Part #</b>
C7185OS	\$41.28	OS243	Start Shaft Seal 16.5x25x5	\$1.96	91205-KA3-712
		OS242	Water Pump Shaft Seal 11x25x7	\$2.74	91211-KRN-671
		OS227	Impeller Shaft Seal 12x22x5	\$2.67	91201-965-000
		OS266	Right Crank Seal 39x52x7	\$10.97	91202-MEB-671
		OS236	Shift Shaft Seal 14x22x5	\$4.23	91203-KA4-771
		OS264	Left Crank Seal 39x52x7	\$10.97	91202-MEB-671
		OS261	Oil Pump Seal 20x33x5	\$2.64	91203-MEB-671
		OS240	Clutch Actuator Seal 12x18x3	\$2.43	91201-951-003
		OS241	Output Shaft Seal 28x37x7	\$2.67	91201-KSR-A01
<b>Clutch &amp; Mag Kit</b>	<b>List Price</b>	<b>Component Part#</b>	<b>Component Description</b>	<b>List Price</b>	<b>OEM Part #</b>
C7185CM	\$12.51	EC957018AFM	Mag Cover Gasket	\$9.32	11395-KRN-670
		R150X2B	Outer Clutch Cover Gasket	\$14.93	11352-KRN-671

All Component Parts can be purchased individually.

**WARNING:** Cancer and Reproductive Harm www.P65Warnings.ca.gov





# MX/Dirt • Off-Road Gaskets



Cometic Gasket - An Exclusive NASCAR Performance® Product

## HONDA CR250R

Model	Year	Bore Size	EST	List Price	Component Part#	Component Description	List Price	OEM Part #		
CRF250R	10-17	78mm	Top End Kit							
			C3288-EST	\$55.38	H3017027S	78mm Bore Head Gasket	\$25.95	12251-KRN-A41		
			C3289-EST	\$55.38	H3017SP3027S	80mm Bore Head Gasket	\$25.95			
		80mm	C3290-EST	\$55.38	H3017SP2027S	82mm Bore Head Gasket	\$25.95			
			B1005014RC		Base Gasket	\$13.47	12191-KRN-A41			
			EX169064AM		Exhaust Gasket	\$1.93	18291-MM5-860			
		82mm	EC960018AFM		Cam Chain Tensioner Gasket	\$3.35	14560-MEN-671			
			3239V		Exh. Valve Seals 08-10 2 Req.	\$5.50 ea.	12208-ML0-721			
			3234V		Int. Valve Seal 2010 2Req.	\$5.50 ea.	12209-GB4-681			
			R19X3V		Water Outlet O-ring	\$3.02	91312-KE7-003			
			<b>Bottom End Kit w/Oil Seals</b>			<b>List Price</b>	<b>Component Part#</b>	<b>Component Description</b>	<b>List Price</b>	<b>OEM Part #</b>
			C3288BE	\$92.58	EC1543032AFM	Inner Clutch Cover Gasket	\$14.93	11394-KRN-A40		
					EC1544020RC	Center Case Gasket	\$11.93	11191-KRN-A40		
					MA0165	Drain Plug Washer	\$0.81	90474-333-000		
		R012V	Oil Relief Valve O-ring	\$1.08	90751-GK1-003					
		R14X2.5V	Timing Mark Cap O-ring	\$1.13	91303-377-000					
		R14X3V	Dipstick O-ring	\$1.13	91307-KRN-A41					
		R114V	Inner Clutch Dowel O-ring	\$1.10	91304-MJ0-003					
		R18X3V	Trans Fluid Fill Plug O-ring	\$1.71	91307-035-000					
		R27X2V	Clutch Cover Drain Plug O-ring	\$1.86	91305-KF0-003					
		R40X2V	Oil Filter O-ring	\$2.82	91302-PA9-003					
		WP369	Water Pump Gasket	\$3.69	19226-KRN-A40					
<b>Oil Seal Kit</b>			<b>List Price</b>	<b>Component Part#</b>	<b>Component Description</b>	<b>List Price</b>	<b>OEM Part #</b>			
C3288OS	\$37.10	OS227	Water Pump Shaft Seal 12x22x5	\$2.67	91201-965-000 (replaces 91201-148-003)					
		OS236	Shift Shaft Seal 14x22x5	\$4.23	91203-KA4-771					
		OS240	Clutch Push Rod Oil Seal 12x18x3	\$2.43	91205-MEB-671					
		OS241	Output Shaft Oil Seal 28x37x7	\$2.67	91201-KSR-A01					
		OS243	Kick Start Shaft Seal 16.5x25x5	\$1.96	91205-KA3-712					
		OS262	Left Case Oil Seal 10x21x5	\$2.60	91204-MEN-A31					
		OS264	Left Crank Seal 38x52x7	\$10.97	91201-MEB-671					
		OS266	Right Crank Seal 39x56x7.5	\$10.97	91202-MEY-671					
		OS387	Balancer Shaft Seal 24x36x8	\$6.17	91205-KE1-004					
<b>Clutch &amp; Mag Kit</b>			<b>List Price</b>	<b>Component Part#</b>	<b>Component Description</b>	<b>List Price</b>	<b>OEM Part #</b>			
C3288CM	\$12.51	R150x2B	Outer Clutch Cover	\$3.19	11352-KRN-A41					
		EC1545032AFM	Mag Cover Gasket	\$9.32	11395-KRN-A40					
CRF250R	2018	79mm	Top End Kit							
			C3635	\$60.40	EX1909	Header Gasket	\$4.99	18291-KSV-J01		
					B1409010RC	Cylinder Base Gasket	\$9.33	12191-K95-A20		
					WA128	Cylinder Base Crush Seal	\$1.29	90463-ML7-000		
					H4584027S	Cylinder Head Gasket 79mm	\$23.96	12251-K95-A21		
					EC2384018AFM	Cam Chain Tensioner Gasket	\$2.22	14523-K95-A21		
					MA0164	Cam Chain Tensioner Crush Washer	\$0.93	90442-397-000		
					3234V	Valve Stem Seal	\$5.50	12209-GB4-681		
					WA116	Rocker Arm Seal	\$1.06	90544-439-930		
					R19X3V	Water Joint O-ring	\$3.02	91312-KE7-003		
					R018B	Cam Tower O-ring	\$2.04	91301-K95-A21		
					WA116	Head Drain Plug O-ring	\$1.06	90544-439-930		
					WA128	Cam Tower Crush Washer	\$1.29	90463-ML7-000		



# MX/Dirt · Off-Road Gaskets



Cometic Gasket - An Exclusive NASCAR Performance® Product

## HONDA XL250

Model	Year	Bore Size	Top End Kit	List Price	Component Part#	Component Description	List Price	OEM Part #
XL250	91-96	74 mm	C7821	\$35.72	H0238030S	74mm Head Gasket .030"	\$24.75	12251-KCZ-013
XR250R	86-95	77 mm	C7893	\$35.72	H1401030S	77mm Head Gasket .030"	\$24.75	
XR250R	96-04	78 mm	C7822	\$35.72	H0192030S	78mm Head Gasket .030"	\$24.75	12251-KCZ-013
					B0144020F	Base Gasket	\$9.32	12191-KZ1-920
			<b>Bottom End Kit w/o crank seals C3330</b>	<b>List Price \$27.44</b>	<b>Component Part#</b>	<b>Component Description</b>	<b>List Price</b>	<b>OEM Part #</b>
			85-87 XL250R		EC424032AFM	Clutch Cover Gasket	\$12.39	11394-KZ1-920
			85 XR200R		EC423060AFM	Mag Cover Gasket	\$8.29	11395-KZ1-920
			91-96 XR250L		EC571020F	Center Case Gasket	\$13.62	11191-KZ1-920
			85-95 XR250R		<b>Component Part#</b>	<b>Component Description</b>	<b>List Price</b>	<b>OEM Part #</b>
					VC033010S	Valve Cover Gasket	\$27.88	12391-KR6-010

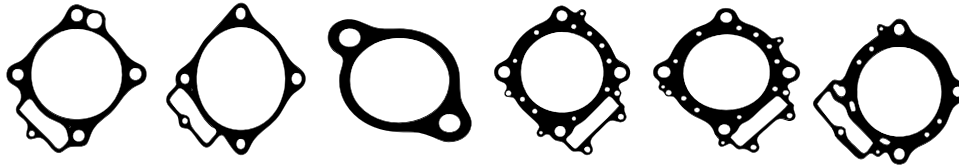

Model	Year	Bore Size	EST	List Price	Component Part#	Component Description	List Price	OEM Part #
CRF450R	02-08	96 mm	C3047-EST	\$72.75	H1301027S	Head Gasket 96mm	\$31.15	
		97 mm	C3554-EST	\$72.75	H1301SP6027S	Head Gasket 97mm	\$31.15	
		99 mm	C3049-EST	\$72.75	H1394027S	Head Gasket 99mm	\$31.15	
					B0548014RC	Base Gasket	\$13.47	12191-MEB-671
					EX657	Exhaust Gasket	\$9.37	18291-MEB-670
					EC898018AFM	Cam Chain Tensioner Gasket	\$3.35	14560-KCW-851
					R011V	Cam Chain Tensioner O-ring	\$2.56	91306-M63-000
					3231V	Exhaust Valve Seals 2 Req.	6.48 ea.	12209-GB4-681
					3234V	Intake Valve Seals 2 Req.	5.50 ea.	12209-KL4-005
					R19X3V	Water Pipe O-ring	\$3.02	91312-KE7-003
					R9.5X1.5V	Cam Chain Tensioner O-Ring	\$2.56	91306-MG3-000

Bottom End Kit w/Oil Seals	List Price	Component Part#	Component Description	List Price	OEM Part #
C3047BE	\$92.60	EC585020F	Center Case Gasket	\$19.82	11191-MEN-850
		EC587020F	Inner Clutch Cover Gasket	16.13	11394-MEB-670
		WP166	Water Pump Cover O-ring	\$4.05	19226-MEB-670
		WA128	Water Pump Drain Crush Seal	\$1.59	90463-ML7-000
		WA128	Water Pump Drain Crush Washer	\$1.59	90463-ML7-000
		WA135	Mag Cover Crush Seal	\$0.80	90474-333-000
		R8.5X2V	Oil Relief Valve O-ring	\$1.10	90751-GK1-003
		R110V	Inner Clutch Cover O-ring	\$1.19	91256-383-721
		R40X2V	Oil Filter O-ring	\$2.82	91302-PA9-003
		R114B	Timing Mark O-ring	\$1.13	91303-377-000
		R27X2V	Right Case Plug O-ring 27x2	\$1.86	91305-KF0-003
		R18X3V	Fill Plug O-ring	\$1.71	91307-035-000
		R18X3V	Fill Plug O-ring	\$1.71	91307-035-000
Oil Seal Kit	List Price	Component Part#	Component Description	List Price	OEM Part #
C3047OS	\$45.45	OS227	Inner Water Pump Shaft Seal	\$2.67	91201-965-000
		OS236	Shift Shaft Seal	\$4.23	91203-KA4-771
		OS238	Output Shaft Seal	\$3.17	91207-ML3-871
		OS239	Start Shaft Seal	\$2.60	91204-KF0-003
		OS240	Clutch Pushrod Seal	\$2.43	91205-MEB-671
		OS261	Balancer Shaft Seal	\$2.64	91203-MEB-671
		OS262	Mag Seal	\$2.60	91204-HP1-601
		OS264	Left Crank Seal	\$10.97	91201-MEB-671
		OS266	Right Crank Seal	\$10.97	91202-MEY-671
		OS242	Impeller Shaft Seal	\$3.17	91211-MEN-A01
Clutch & Mag Kit	List Price	Component Part#	Component Description	List Price	OEM Part #
C3047CM	\$29.75	EC765060AFM	Clutch Cover Replaces O-ring	\$13.62	11352-MEB-671
		EC586060AFM	Mag Cover Gasket	\$16.13	11352-MEB-671
		Component Part#	Description	List Price	OEM Part#
		VC100	Valve Cover Gasket	\$15.44	12391-MEB-670



# MX/Dirt • Off-Road Gaskets



Cometic Gasket - An Exclusive NASCAR Performance® Product

## HONDA CRF450R

Model	Year	Bore Size	EST	List Price	Component Part#	Component Description	List Price	OEM Part #		
CRF450R	09-16	96mm	Top End Kit							
			C3270-EST	\$89.38	H2856027S	Head Gasket 97.5mm Stock	\$43.39	12251-MEN-A31		
			C3275-EST	\$89.38	H2856SP1027S	Head Gasket 98.5mm	\$43.39			
		98mm	C3276-EST	\$89.38	H2856SP3027S	Head Gasket 100mm	\$43.39			
			B0969010RC		Base Gasket	\$15.72	12191-MEN-A31			
			EX657		Exhaust Gasket	\$9.37	18291-MEB-670			
		100mm	EC960018AFM		Cam Chain Tensioner Gasket	\$3.35	14560-MEN-671			
			3234V		Valve Seals	5.50 ea.	12209-GB4-682			
			R19X3V		Water Pipe O-ring	\$3.02	91312-KE7-003			
		R22X2.5V		Cylinder Water Outlet O-ring	\$2.21	91355-759-003				
		EX657		Exhaust Gasket	\$9.37	18291-MEB-670				
		<b>Bottom End Kit w/Oil Seals</b>								
					<b>List Price</b>		<b>Component Part#</b>	<b>Component Description</b>	<b>List Price</b>	<b>OEM Part #</b>
		C3270BE	\$93.96	WA135	Drain Plug Washer	\$0.80	90474-333-000			
				EC1415020F	Center Crankcase Gasket	\$19.82	11191-MEN-A30			
				R16X3V	Neutral Switch O-ring	\$1.26	91305-KC1-850			
				R40X2V	Oil Filter Cover Gasket	\$2.82	91302-035-000/ 91302-PA9-003			
				R14X2.5V	Timing Plug O-ring	\$1.13	91303-377-000			
				R18X3V	Dipstick O-ring	\$1.71	91307-035-000			
				R8.5X1.5V	Oil Pressure Relief Valve O-ring	\$1.13	90751-GK1-003			
				EC1414018AFM	Inner Clutch Cover Gasket	\$19.82	11394-MEN-A30			
				WP296	Water Pump Cover Gasket	\$3.43	19226-MEN-A30			
				R27X2V	Right Case Plug O-ring	\$1.86	91305-KF0-003			
				R27X2V	Clutch Oil Fill Plug O-ring	\$1.86	91307-035-000			
<b>Oil Seal Kit</b>										
			<b>List Price</b>		<b>Component Part#</b>	<b>Component Description</b>	<b>List Price</b>	<b>OEM Part #</b>		
		C3270OS	\$38.90	OS266	Right Crank Seal 39x56x7.5	\$10.97	91202-MEY-671			
				OS264	Left Crank Seal 38x52x7	\$10.97	91201-MEB-671			
				OS236	Shift Shaft Oil Seal 14x22x5	\$4.23	91203-KA4-771			
				OS240	Clutch Actuator Oil Seal 12x18x3	\$2.43	91205-MEB-671			
				OS262	Crank End Oil Seal 10x21x5	\$2.60	91204-MEN-A31			
				OS239	Kickstart Shaft Seal 20x28x5	\$2.60	91204-KF0-003			
				OS227	Water Pump Seal 12x22x5	\$2.67	91201-965-000			
				OS238	Output Shaft Seal 31x40x7	\$3.17	91207-ML3-871			
<b>Clutch &amp; Mag Kit</b>										
			<b>List Price</b>		<b>Component Part#</b>	<b>Component Description</b>	<b>List Price</b>	<b>OEM Part #</b>		
		C3270CM	\$29.75	EC1416032AFM	Generator Cover Gasket	\$16.13	11395-MEN-A30			
				EC978	Outer Clutch Cover O-ring	\$5.87	11352-MEB-671			
CRF450	17-18	96mm	Top End Kit							
			C3621	\$69.99	3234V	Valve Seals		18291-MEB-670		
					B1366014RC	Base Gasket		12191-MKE-A01		
					EC960018AFM	Cam Chain Tensioner Gasket		14560-MEN-671		
					EX657	Exhaust Gasket		18291-MEB-670		
					H4417023S	Head Gasket 96mm Bore		12251-MKE-A01		
					MA0164	Cam Chain Tensioner Washer		90442-397-000		
					R19X3V	Water Joint O-ring		91312-KE7-003		



# MX/Dirt • Off-Road Gaskets



Cometic Gasket - An Exclusive NASCAR Performance® Product

## HONDA CRF450X

Model	Year	Bore Size	EST	List Price	Component Part#	Component Description	List Price	OEM Part #		
CRF450X	05-15	96mm	<b>Top End Kit</b>							
			C3134-EST	\$89.38	H2458027S	Head Gasket 96mm Bore	\$37.39	12251-MEY-671		
			C3555-EST	\$89.38	H2458SP3027S	Head Gasket 97mm Bore	\$37.39			
		97mm	C3556-EST	\$89.38	H2458SP1027S	Head Gasket 98mm Bore	\$37.39			
		98mm	C3557-EST	\$89.38	H2459027S	Head Gasket 99mm Bore	\$37.39			
		99mm			3231V	Exhaust Valve Seals 2 Req.	\$6.48 ea.	12209-GB4-681		
					3234V	Intake Valve Seals 2 Req.	\$5.50 ea.	12209-KL4-005		
					B0891020RC	Base Gasket	\$20.99	12191-MEB-671		
					EC960018AFM	Cam Chain Tensioner Gasket	\$3.35	14560-MEN-671		
					EX657	Exhaust Gasket	\$9.37	18291-MEB-670		
					R117B	Water Outlet O-ring	\$0.42	91312-KE7-003		
					<b>Component Part#</b>	<b>Description</b>	<b>List Price</b>	<b>OEM Part#</b>		
					VC100	VC100 Valve Cover Gasket	\$15.44	12391-MEB-670		
					<b>Bottom End Kit w/Oil Seals</b>	<b>List Price</b>	<b>Component Part#</b>	<b>Component Description</b>	<b>List Price</b>	<b>OEM Part #</b>
					C3134BE	\$92.60	EC1064020F	Center Case Gasket	\$10.56	11191-MEY-671
					R8.5X1.5V	Oil Relief O-Ring	\$1.13	90751-GK1-003		
					R40X2V	Oil Filter O-Ring	\$2.82	91302-PA9-003		
					R14X2.5V	Timing Mark O-ring	\$1.13	91303-377-000		
					R18X3V	Dipstick O-ring	\$1.71	91307-377-000		
					WA135	Left Cover Drain Washer	\$0.80	90474-333-000		
					EC1065018AFM	Inner Clutch Cover	\$14.25	11394-MEY-671		
					R18X3V	Trans Fill Plug O-ring	\$1.71	91307-035-000		
					R18X2.5V	Water Galley O-ring	\$1.71	91256-383-721		
					WA118	Right Case Drain Seal	\$1.88	90463-ML7-000		
					R27X2V	Crank End Plug O-ring	\$1.86	91305-KF0-003		
					R22X2.5V	Water Outlet O-ring	\$2.21	91355-759-003		
					WP166	Water Pump Gasket	\$4.05	19226-MEB-670		
					WA128	Water Pump Drain Gasket	\$1.59	90463-ML7-000		
			<b>Oil Seal Kit</b>	<b>List Price</b>	<b>Component Part#</b>	<b>Component Description</b>	<b>List Price</b>	<b>OEM Part #</b>		
			C3134OS	42.28	OS266	Right Crank Seal 39X56X7.5	\$10.97	91202-MEY-671		
					OS240	Clutch Pushrod Seal 12x18x3	\$2.43	91205-MEB-671		
					OS264	Left Crank Seal 38x52x7	\$10.97	91201-MEB-671		
					OS261	Balancer Seal 20x33x5	\$2.64	91203-MEB-671		
					OS236	Shift Shaft Seal 14x22x5	\$4.23	91203-KA4-771		
					OS262	Left Case Cover Oil Seal 10X21X5	\$2.60	91204-KRN-671		
					OS239	Start Shaft Oil Seal 20x28x5	\$2.60	91204-KF0-003		
					OS238	Output Shaft Seal 31x40x7	\$3.17	91207-ML3-871		
					OS227	Water Pump Seal 12X22X5	\$2.67	91201-148-003		
			<b>Clutch &amp; Mag Kit</b>	<b>List Price</b>	<b>Component Part#</b>	<b>Component Description</b>	<b>List Price</b>	<b>OEM Part #</b>		
			C3134CM	\$13.20	EC978	Clutch Cover O-ring	\$5.87	11352-MEB-671		
					EC586032AFM	Mag Cover Gasket	\$7.33	11352-MEB-671		

## HONDA CR480

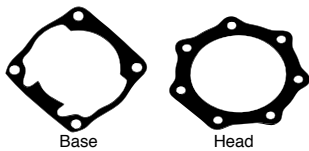

Model	Year	Bore Size	Top End Kit	List Price	Component Part#	Component Description	List Price	OEM Part #
CR480	82-83	91 mm	C7017	\$27.65	H0011020C	91mm Head Gasket	\$25.73	12254-KA5-770
					B0015020F	Base Gasket	\$6.25	12191-MA0-000
					<b>Component Part#</b>	<b>Component Description</b>	<b>List Price</b>	<b>OEM Part #</b>
					EC801032AFM	Clutch Cover Gasket	\$14.93	31129-KA4-000/ 11395-KA4-000/306

All Component Parts can be purchased individually.

**WARNING:** Cancer and Reproductive Harm [www.P65Warnings.ca.gov](http://www.P65Warnings.ca.gov)





Cometic Gasket - An Exclusive NASCAR Performance® Product

## HONDA XR500

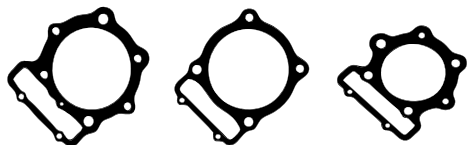

Base Base Head

Model	Year	Bore Size	Top End Kit	List Price	Component Part#	Component Description	List Price	OEM Part #
XL500	79-82	91 mm	C7147	\$31.91	H0265043F	91mm Head Gasket	\$20.99	06130-MC4-000
XR500	79-82	95 mm	C7148	\$31.91	H0260043F	95mm Head Gasket	\$24.75	06130-MC4-000
					B0173020F	Base Gasket	\$9.94	12191-MA0-306
					<b>Component Part#</b>	<b>Component Description</b>	<b>List Price</b>	<b>OEM Part #</b>
					EC401032AFM	Clutch Cover Gasket	\$12.39	11394-MN1-700
			<b>Top End Kit</b>	<b>List Price</b>	<b>Component Part#</b>	<b>Component Description</b>	<b>List Price</b>	<b>OEM Part #</b>
XR500	83-84	93 mm	C7238	\$31.91	B0205020F	Base Gasket	\$7.16	12191-MN1-700
					H0257043F	Head Gasket 93mm Bore	\$27.26	12251-MK4-602
					<b>Component Part#</b>	<b>Component Description</b>	<b>List Price</b>	<b>OEM Part #</b>
					EC401032AFM	Clutch Cover Gasket	\$12.39	11394-MN1-700

## HONDA CR500



Base Exhaust Intake

Model	Year	Bore Size	Top End Kit	List Price	Component Part#	Component Description	List Price	OEM Part #
CR500	84	91 mm	C7018	\$48.44	B0016020F	Base Gasket	\$7.16	12191-ML3-790
					H0011020C	Head Gasket	\$25.73	12254-KA5-770
					IR006018AFM	Intake Gasket	\$3.80	14132-KA5-740
					<b>Component Part#</b>	<b>Component Description</b>	<b>List Price</b>	<b>OEM Part #</b>
					C7490	Clutch Cover Gasket	\$11.47	91311-KS7-701
			<b>Top End Kit</b>	<b>List Price</b>	<b>Component Part#</b>	<b>Component Description</b>	<b>List Price</b>	<b>OEM Part #</b>
CR500	85-88	91 mm	C7019	\$42.13	H0012043F	Head Gasket	\$22.32	12254-ML3-881
					B0016020F	Base Gasket	\$7.16	12191-ML3-790
					IR006018AFM	Intake Gasket	\$3.80	14132-KA5-740
					EX009042AM	Exhaust Gasket	\$4.65	18291-ML3-791
					<b>Component Part#</b>	<b>Component Description</b>	<b>List Price</b>	<b>OEM Part #</b>
					C7490	Clutch Cover Gasket	\$11.47	91311-KS7-701
			<b>Top End Kit</b>	<b>List Price</b>	<b>Component Part#</b>	<b>Component Description</b>	<b>List Price</b>	<b>OEM Part #</b>
CR500	89-01	91 mm	C7020	\$42.13	H0300010S	Head Gasket	\$30.95	12254-ML3-680
					B0017018AFM	Base Gasket	\$9.32	12191-MAC-680
					B0017012F	High Compression Base Gasket .012"	\$9.32	
					IR006018AFM	Intake Gasket	\$3.80	14132-KA5-740
					EX009042AM	Exhaust Gasket	\$4.65	18291-ML3-791
			<b>Bottom End Kit w/Oil Seals</b>	<b>List Price</b>	<b>Component Part#</b>	<b>Component Description</b>	<b>List Price</b>	<b>OEM Part #</b>
			C7020BE	\$68.56	EC818020F	Center Case Gasket	\$14.87	11191-MAC-680
					WA137	Drain Plug Gasket	\$1.53	94109-12000
					EC602032AFM	Inner Clutch Cover	\$12.99	11395-MAC-680
					R16X3V	Fill Plug O-ring	\$1.26	91303-800-000
					WA128	Right Case Cover Drain Seal	\$1.59	90463-ML7-000
					WP235018AFM	Water Pump Cover Gasket	\$3.49	19229-MAC-680
CR500	84-88		C7772	\$67.99	Special 5mm Base Kit for 89-01 Con. Rod. Includes Shim and 2 Base Gaskets for Use With Late Model (89-01) Rod on Early Model (84-88) Engines			



# MX/Dirt · Off-Road Gaskets



Cometic Gasket - An Exclusive NASCAR Performance® Product

## HONDA XR500

Model	Year	Bore Size	Oil Seal Kit	List Price	Component Part#	Component Description	List Price	OEM Part #			
CR500	89-01	91 mm	C7020OS	\$37.92	OS103	Left Crank Seal 20x32x7	\$9.47	91205-166-004			
					OS106	Right Crank Seal 38x58x11	\$10.68	91201-KA4-004			
					OS227	Water Pump Shaft Seal 12x22x5	\$2.67	91201-965-000			
					OS236	Shift Shaft Seal 14x22x5	\$4.23	91203-KK3-830			
					OS238	Output Shaft Seal 31X40X7	\$3.17	91207-ML3-871			
					OS239	Start Shaft Seal 20x28x5	\$2.60	91204-KF0-003			
					OS240	Clutch Pushrod Seal 12x18x3	\$2.43	91201-951-003			
					OS242	Impeller Seal 12x25x7	\$5.06	91211-KA3-761			
					Clutch & Mag Kit	C7020CM	\$14.92	Component Part#	Component Description	List Price	OEM Part #
C7490	Outer Clutch Cover O-ring	\$11.47	91311-KS7-701								
CR500	84-88		C7772	\$67.99	Special 5mm Base Kit for 89-01 Con. Rod. Includes Shim and 2 Base Gaskets for Use With Late Model (89-01) Rod on Early Model (84-88) Engines						

## HONDA XL/XR 600/650

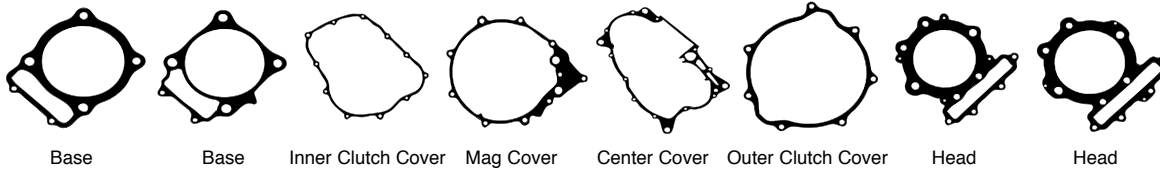

Model	Year	Bore Size	Top End Kit	List Price	Component Part#	Component Description	List Price	OEM Part #
XL600	83-87	103 mm	C7149	\$31.91	H0270SP3040S	Head Gasket	\$24.75	12251-MG2-004
					B0145020F	Base Gasket	\$9.32	12191-MN1-700
					EC401032AFM	Clutch Cover	\$12.39	11394-MN1-700
					Bottom End Kit			
XR600	88-00	98 mm	C7827	\$38.33	H0239030S	Head Gasket 98mm Bore	\$29.19	12251-MN1-671
					H1407030S	Head Gasket 100mm Bore	\$29.19	12251-MN1-671
					H0317030S	Head Gasket 101mm Bore	\$29.19	12251-MN1-671
					H0317SP2030S	Head Gasket 102mm Bore	\$29.19	12251-MN1-671
					H0221030S	Head Gasket 103mm Bore	\$29.19	12251-MN1-671
					B0145020F	Base Gasket	\$9.32	12191-MN1-700
					EC401032AFM	Clutch Cover	\$12.39	11394-MN1-700
					EC402060AFM	Mag Cover Gasket	\$12.39	11352-MN1-680
					EC403020F	Center Case Gasket	\$12.39	11191-MN1-700
					VC031010S	Valve Cover Gasket	\$33.17	12391-MG2-790
XR650L	93-12	103 mm	C3216	\$31.91	H1675SP3030S	103mm Head Gasket	\$21.21	12251-MN9-742
					B0145020RC	Base Gasket	\$12.39	12191-MN1-700
					EC619032AFM	Clutch Cover Gasket	\$12.39	11394-MY2-621
XR650R	00-07	101 mm	C7681	\$38.33	B0462020F	Base Gasket	\$9.32	12191-MBN-670
					H0983018S	101mm Bore Head Gasket	\$30.95	12251-MBN-671
					H1047018S	103mm Bore Head Gasket	\$30.95	12251-MBN-671
					EC891060AFM	Clutch Cover Gasket	\$15.44	11352-MBN-671
					C7753	\$38.33		

All Component Parts can be purchased individually.

**WARNING:** Cancer and Reproductive Harm www.P65Warnings.ca.gov



# MX/Dirt • Off-Road Gaskets



Cometic Gasket - An Exclusive NASCAR Performance® Product

## HUSABERG TE250



Base



Inner Clutch

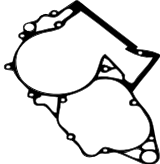

Center Case



Power Valve

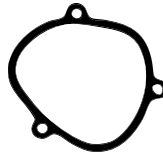

Power Valve

Model	Year	Bore Size	Top End Kit	List Price	Component Part#	Component Description	List Price	OEM Part #
TE250	11-13	O-Ring	C3222	\$38.33	WA135	Head Seal Crush Washer 6 Req.	\$0.77	56530080000
TE300	11-13				R78X2V	Inner Head O-ring 78,00X2,00	\$11.41	0770078020
					R105X2B	Outer Head O-ring 105,00X2,00	\$11.41	0770105020
					PV136032AFM	Left Side Power Valve Gasket	\$4.54	54837006000
					R11.5X2.5B	Front Power Valve Orings 4 Req.	\$0.94	0770116241
					R44X3S	Exhaust O-rings 44,00X3,00	\$2.71	0770440030
					PV137032AFM	Right Side Power Valve	\$4.81	54837008000
					B0666018AFM	Base Gasket.018" (0,4mm)	\$6.01	54830030004
					R15X1.5V	Power Valve Control O-ring 15x1.5	\$1.09	0770150151
					R16X2V	Control Valve O-ring (300) 16x2	\$2.90	0770160021
					R114V	Power Valve Control Cap O-ring 12,37X2,62	\$1.14	0770021120
					R24X2V	Power Valve Control Guide O-ring 24,00X2,00 NBR70	\$5.95	0770240020

Bottom End Kit	List Price	Component Part#	Component Part#	List Price	OEM Part#
C7943BE	\$95.99	WA133	Clutch Slave Cyl. Crush Washer	\$0.90	0603100141
		R30X1.5V	Clutch Slave Cylinder O-ring	\$2.29	0770300015
		R19X3V	Fill Plug O-ring	\$3.02	0770191015
		WA133	Water Pump Crush Washer	\$0.90	0603100141
		R0050	Water Pump Gasket	\$11.30	54835003000
		WA137	Drain Plug Crush Washer	\$1.53	58038022000
		WA133	Water Pump Cover	\$0.90	0603061001
			Crush Washer		
		R25X1.5V	Crank Backup O-ring	\$6.19	0770250015
		EC778032AFM	Primary Cover Gasket (Inner Clutch)	\$14.90	54830024100
		EC779020F	Center Case Gasket	\$9.50	54830039000
		IR386018AFM	Intake Reed Gasket	\$4.37	54830062200
		R25X2V	Output Shaft Backup O-ring	\$3.21	0770250020
		R24X2V	Exhaust Valve Control O-ring	\$6.19	0770240020
		R114V	Spring Guide O-ring	\$1.10	0770021120

Oil Seal Kit	List Price	Component Part#	Component Description	List Price	OEM Part #
C7943OS	\$44.40	OS136	Left Crank Seal 25x35x7	\$15.99	760253570
		OS137	Right Crank Seal 38x52x7	\$15.99	760385273
		OS197	Shift Shaft Seal 14x24x6	\$2.46	760142460
		OS202	Water Pump Shaft Seal 8x24x7	\$7.56	760082472
		OS310	Start Shaft Seal 19x30x7	\$4.29	760193070
		OS390	Output Shaft Seal 32x45x7	\$3.05	760324571

Clutch & Mag Kit	List Price	Component Part#	Component Description	List Price	OEM Part #
C7943CM	\$27.47	R0049	Clutch Cover O-ring	\$15.70	55130027000
		EC777032AFM	Mag Cover Gasket	\$11.75	



# MX/Dirt · Off-Road Gaskets



Cometic Gasket - An Exclusive NASCAR Performance® Product

## HUSQVARNA TC65

Model	Year	Bore Size	Top End Kit	List Price	Component Part#	Component Description	List Price	OEM Part #
TC65	09-19	O-Ring	C3416	\$35.51	MR106	Cylinder Head Gasket	\$6.90	45230036000
					WA146	Cyl. Head Crush Washer 4 Req.	\$2.16	50230032010
					B0976018AFM	Cyl. Base Gasket	\$6.25	46230035040
					EX943059F	Header Flange Gasket	\$4.77	46205004000
					R15X1.5V	Power Valve Control O-ring	\$1.13	0770150151
					R005B	Power Valve Base Orings 2 Req.	\$0.11	0770030015
					WA133	Power Valve Base Seal Washer	\$0.90	603061001
					WA133	Power Valve Copper Seal	\$0.90	603050901
					IR747018AFM	Reed Valve Gasket	\$4.37	46230049000

Bottom End Kit w/o crank seals C3416BE	List Price	Component Part#	Description	List Price	OEM Part#
		EC1357020F	Center Case Gasket	\$16.13	46230039000
		WA133	Coolant Drain Plug	\$0.90	0603061001
		WA137	Trans Drain Plug Crush Washer	\$1.53	58038022000
		EC2204018AFM	Primary Cover Gasket	\$9.32	46230025100
		R19X3V	Fill Plug O-ring	\$3.02	0770191015
		R16X2V	Crank Back up O-ring	\$3.02	0770160021
		IR747018AFM	Intake Gasket	\$4.73	46230049000
		EC1360018AFM	Slave Cylinder Gasket	\$4.73	59032065000
		R027V	Slave Cylinder O-ring	\$1.10	0770031018
		R20X2	Countershaft Back Up Ring	\$3.02	0770020020
		WP496	Water Pump Gasket	\$18.25	45235053000

Oil Seal Kit C3416OS	List Price	Component Part#	Component Description	List Price	OEM Part #
	\$32.99	OS294	Right Crank Seal 30x47x7	\$16.79	0760304772
		OS199	Left Crank Seal 20x35x6	\$17.45	47030076100
		OS389	Countershaft Seal 26x35x6	\$4.79	0760263561
		OS357	Start Shaft Seal 17x28x6	\$5.07	0760172860
		OS339	Shift Shaft Seal 12x20x5	\$2.59	0760122050
		OS202	Water Pump Seal 8x24x7	\$7.56	0760082472
		MR162	Clutch Cover O-ring	\$9.29	46230027000

Clutch & Mag Kit C3416CM	List Price	Component Part#	Component Description	List Price	OEM Part #
	\$18.61	MR162	Clutch Cover O-ring	\$9.29	46230027000
		EC1358032AFM	Mag Cover Gasket	\$9.32	

## HUSQVARNA TC85

Model	Year	Bore Size	Top End Kit	List Price	Component Part#	Component Description	List Price	OEM Part #
TC85	18-19	O-ring	C3636	\$36.81	WA133	Head Crush Washers	\$0.90	603061001
					R23X2.5V	Dome O-ring	\$1.65	7702300251
					R54X2V	Inner Chamber O-ring	\$4.14	770540020
					R80X2S	Outer Chamber O-ring	\$5.29	770800021
					PV158018AFM	RT Power Valve Cover Gasket	\$3.59	47237008000
					PV157018AFM	LT Power Valve Cover Gasket	\$3.59	47237006000
					B1408	Base Gasket	\$7.16	47230035020
					B1408010RC	Base Gasket	\$7.16	47230035025
					B1408014RC	Base Gasket	\$7.16	47230035040
					B1408020RC	Base Gasket	\$7.16	47230035050
					B1408031F	Base Gasket	\$7.16	47230035075
					WA133	Power Valve Cover Crush Washer	\$0.90	603061001
					R8X2V	Power Valve Flap O-ring	\$1.59	770080201
					R114V	Power Valve Spring Cover	\$1.10	770021120
					R24X2V	Power Valve Spring Cover	\$6.19	770240020

All Component Parts can be purchased individually.



**WARNING:** Cancer and Reproductive Harm [www.P65Warnings.ca.gov](http://www.P65Warnings.ca.gov)





# MX/Dirt • Off-Road Gaskets



Cometic Gasket - An Exclusive NASCAR Performance® Product

## HUSQVARNA CR/WR 125

Model	Year	Bore Size	Top End Kit	List Price	Component Part#	Component Description	List Price	OEM Part #
CR/WR	97-12	O-Ring	C7734	\$24.02	R038V	Inner Head O-Ring	\$1.14	
					R044S	Outer Head O-Ring	\$3.77	8000 94652
					B0445018AFM	Base Gasket	\$5.95	8B00 83068
					WA116	Head Crush Washers 5 Req.	\$1.06	8000 39335
					R49X2.5V	Power Valve Cover O-ring	3.14	8000 28553
					R019V	Right Side Power Valve Housing O-ring	\$0.57	8000 19789
					R222V	Expansion Chamber Head O-ring	\$5.31	8A00 23186
					IR146032AFM	Intake Gasket	\$4.47	8000 83043
					PV093032AFM	Power Valve	\$5.68	8000 83091
					PV092018AFM	Power Valve	\$5.68	8000 83049
			<b>Bottom End Kit w/o crank seals</b>	<b>List Price</b>	<b>Component Part#</b>	<b>Description</b>	<b>List Price</b>	<b>OEM Part#</b>
			C3373	\$31.29	WP103018AFM	Water Pump Gasket	\$1.66	8000 65922
					EC430015F	Case Gasket	\$12.39	8000 72889
					IR146032AM	Intake Gasket	\$4.65	8000 83043
					WA120	Drain Plug Washer	\$.83	62N0 15678
					EC431032AFM	Inner Clutch Cover Gasket	\$18.99	8000 66968
					R0071063N	Fill Plug O-ring	\$1.39	8000 27960
					EC432031F	Mag Cover Gasket	\$7.10	8000 66972
					R109V	Output Shaft O-ring	\$0.57	8000 19789

## HUSQVARNA TC125

Model	Year	Bore Size	Top End Kit	List Price	Component Part#	Component Description	List Price	OEM #
TC125	16-19	O-Ring	C3606	\$60.26	B1348010RC	Base Gasket	\$7.19	50430035025
					B1348014RC	Base Gasket	\$7.19	50430035040
					B1348018AFM	Base Gasket	\$7.19	50430035050
					B1348032AFM	Base Gasket	\$7.19	50430035075
					IR1355032AFM	Reed Cage Gasket	\$4.37	50430098050
					MR163	Exhaust Valve Cover Gasket	\$9.29	50437046000
					PV152032AFM	Left Side Exhaust Valve Cover	\$5.29	50437006000
					PV153032AFM	Right Side Exhaust Valve Cover	\$5.29	50437008000
					R14X2V	Power Valve Control O-rings	\$1.13	0770140201
					R23X2.5V	Dome O-ring 23x2.5	\$1.65	07702300251
					R60X2V	Inner Head O-ring 60x2	\$4.84	0770600200
					R89X2V	Outer Head O-ring 89X2	\$2.98	0770890200
					WA133	Head Drain Crush Washer 6X10X1	\$0.90	0603061001
					WA146	Cylinder Head Crush Washer 7.3X12X1 (6)	\$2.16	0603070121
					IR1356032AFM	Intake Gasket	\$4.37	50430098060
			<b>Bottom End Kit w/Oil Seals</b>	<b>List Price</b>	<b>Component Part#</b>	<b>Component Description</b>	<b>List Price #</b>	<b>OEM Part #</b>
			C3606BE	\$93.89	EC2182020F	Center Case Gasket	\$18.39	50430039000
					WA137	Copper Drain Plug Crush Washer 12X18X1.5	\$1.53	58038022000
					R19X3V	Fill Plug O-Ring 19x3	\$3.02	0770191015
					WA133	Water Passage Crush Washer	\$0.90	0603061001
					WA133	Clutch Drain Plug Gasket	\$0.90	0603100141
					EC2183032AFM	Inner Clutch Cover Gasket	\$10.78	50430025000
					R25X2V	Primary Gear Back Up Ring 25x2	\$3.21	0770250020
					R30X1.5V	Slave Cylinder O-ring 30x1.5	\$2.29	0770300015
					WA135	Clutch Cable Crush Washer 8x16x1	\$0.80	0603080161
					R23X2V	Output Shaft Back Up O-ring 23x2	\$4.09	0770230020
					WP500	Water Pump Gasket	\$8.09	50435053000
			<b>Oil Seal Kit</b>	<b>List Price</b>	<b>Component Part#</b>	<b>Component Description</b>	<b>List Price #</b>	<b>OEM Part #</b>
			C3606OS	\$42.14	OS217	Left Crank Seal 25X35X7	\$15.59	0760253570
					OS141	Right Crank Seal 32X45X6.5	\$19.39	0760324564
					OS141	Output Shaft Seal 32X45X7	\$3.39	0760324571
					OS310	Start Shaft Seal 19X30X7	\$4.29	0760193070
					OS197	Shift Shaft Seal 14X24X6	\$2.46	0760142460
					OS202	Water Pump Seal 8x24x7	\$7.56	0760082472
					<b>Component Part#</b>	<b>Component Part#</b>	<b>List Price</b>	<b>OEM Part#</b>
					R0078	Outer Clutch Cover O-ring	\$8.69	50430027000

All Component Parts can be purchased individually.



**WARNING:** Cancer and Reproductive Harm [www.P65Warnings.ca.gov](http://www.P65Warnings.ca.gov)



# MX/Dirt · Off-Road Gaskets



Cometic Gasket - An Exclusive NASCAR Performance® Product

## HUSQVARNA TE150

Model	Year	Bore Size	Top End Kit	List Price	Component Part#	Component Description	List Price	OEM #
TE150	17-19	O-Ring	C3607	\$60.26	B1348010RC	Base Gasket	\$7.19	50430035025
					B1348014RC	Base Gasket	\$7.19	50430035040
					B1348018AFM	Base Gasket	\$7.19	50430035050
					B1348032AFM	Base Gasket	\$7.19	50430035075
					IR1355032AFM	Reed Cage Gasket	\$4.37	50430098050
					MR163	Exhaust Valve Cover Gasket	\$9.29	50437046000
					PV152032AFM	Left Side Exhaust Valve Cover	\$5.29	50437006000
					PV153032AFM	Right Side Exhaust Valve Cover	\$5.29	50437008000
					R14X2V	Power Valve Control O-rings	\$1.13	0770140201
					R23X2.5V	Dome O-ring 23x2.5	\$1.65	07702300251
					R64X2V	Inner Head O-ring 60x2	\$4.84	0770600200
					R89X2V	Outer Head O-ring 89X2	\$2.98	0770890200
					WA133	Head Drain Crush Washer 6X10X1	\$0.90	0603061001
					WA146	Cylinder Head Crush Washer 7.3X12X1 (6)	\$2.16	0603070121
					IR1356032AFM	Intake Gasket	\$4.37	50430098060
						<b>Component Description</b>	<b>List Price #</b>	<b>OEM Part #</b>
			<b>Bottom End Kit w/Oil Seals</b>	<b>List Price</b>	<b>Component Part#</b>			
			C3606OS	\$93.89	EC2182020F	Center Case Gasket	\$18.39	50430039000
					WA137	Copper Drain Plug Crush Washer 12X18X1.5	\$1.53	58038022000
					R19X3V	Fill Plug O-Ring 19x3	\$3.02	0770191015
					WA133	Water Passage Crush Washer	\$0.90	0603061001
					WA133	Clutch Drain Plug Gasket	\$0.90	0603100141
					EC2183032AFM	Inner Clutch Cover Gasket	\$10.78	50430025000
					R25X2V	Primary Gear Back Up Ring 25x2	\$3.21	0770250020
					R30X1.5V	Slave Cylinder O-ring 30x1.5	\$2.29	0770300015
					WA135	Clutch Cable Crush Washer 8x16x1	\$0.80	0603080161
					R23X2V	Output Shaft Back Up O-ring 23x2	\$4.09	0770230020
					WP500	Water Pump Gasket	\$8.09	50435053000
					WA133	Water Pump Cover Drain Plug Crush Washer 6X10X1	\$0.90	0603061001
					R114V	Power Valve Adjuster O-Ring 12.37X2.62	\$1.10	0770021120
						<b>Component Description</b>	<b>List Price #</b>	<b>OEM Part #</b>
			<b>Oil Seal Kit</b>	<b>List Price</b>	<b>Component Part#</b>			
			C3606OS	\$42.14	OS217	Left Crank Seal 25X35X7	\$15.59	0760253570
					OS141	Right Crank Seal 32X45X6.5	\$19.39	0760324564
					OS141	Output Shaft Seal 32X45X7	\$3.39	0760324571
					OS310	Start Shaft Seal 19X30X7	\$4.29	0760193070
					OS197	Shift Shaft Seal 14X24X6	\$2.46	0760142460
					OS202	Water Pump Seal 8x24x7	\$7.56	0760082472
						<b>Component Part#</b>	<b>List Price</b>	<b>OEM Part#</b>
					R0078	Outer Clutch Cover O-ring	\$8.69	50430027000

All Component Parts can be purchased individually.

**WARNING:** Cancer and Reproductive Harm [www.P65Warnings.ca.gov](http://www.P65Warnings.ca.gov)



# MX/Dirt • Off-Road Gaskets



Cometic Gasket - An Exclusive NASCAR Performance® Product

## HUSQVARNA WR250/CR250

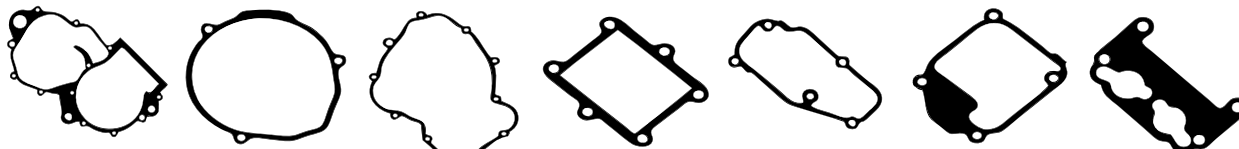

Model	Year	Bore Size	Top End Kit	List Price	Component Part#	Component Description	List Price	OEM Part #
WR250	99-12	O-Ring	C7743	\$31.14	R041V	Inner Head O-Ring	\$5.30	8A00 44117
CR250	99-12				R157B	Outer Head O-Ring	\$3.92	8A00 63593
					B0464018AFM	Base Gasket	\$8.69	8A00 86902
					PV095018AFM	Left Side Power Valve Cover	\$5.91	8000 86868
					PV094018AFM	Right Side Power Valve Cover	\$2.98	8000 86865
					IR148018AFM	Intake Gasket	\$2.13	8000 89954
					B0464010RC	Base Gasket(0,3 mm)	\$8.69	8000 86902
						.011" Available Separately		
					B0464020RC	Base Gasket (0,5 mm)	\$8.69	8B00 86902
						.019" Available Separately		
					B0464032AFM	Base Gasket (0,8 mm)	\$8.69	8C00 86902
						.031" Available Separately		
					R014V	Power Valve Cover	\$1.08	8A00 23109
						O-rings 4 Req.		
					R017V	Front Power Valve Large O-ring	\$0.50	8000 36380
					R021V	Front Power Valve Large O-ring	\$1.19	8B00 42700
						2002		
					R015V	Exhaust Valve Flap O-ring 2 Req.	\$1.13	8A00 22551
					R45X3.5V	Exp. Chamber Head O-ring	\$1.64	8A00 31970
					EX1311027C	Exp. Chamber Head Washer	\$1.69	8A00 73541
						<b>Description</b>	<b>List Price</b>	<b>OEM Part#</b>
			<b>Bottom End Kit</b>	<b>List Price</b>	<b>Component Part#</b>			
			w/o crank seals					
			C3374	\$55.41	R132B	Water Pump Gasket	\$1.69	8000 19965
					EC451020F	Case Gasket	\$5.09	8000 72522
					R165B	Clutch Cover O-ring	\$3.92	8000 86878
					EC453032AFM	Inner Clutch Cover Gasket	\$18.99	8000 34451
					EC452060AFM	Mag Cover Gasket	\$8.29	8000 69372

## HUSQVARNA FC250

Model	Year	Bore Size	Top End Kit	List Price	Component Part#	Component Description	List Price	OEM Part #
TC250	10-12	79mm	C3505-EST	\$80.22	R013B	Breather Seal O-ring	\$1.19	8000 01199
TE/TXC250					3239V	Valve Stem Seal 4 Req.	\$5.50	8000 A6356
					R12X1.5V	Cam Gear Shaft O-ring 2 Req.	\$0.84	8000 H6884
					EC1826018AFM	Cam Gear Shaft Gasket	\$3.35	8000 A6627
					WP424018AFM	Water Pump Body Gasket	\$1.71	8000 H6126
					WP416018AFM	Water Pump Body Gasket 2012	\$1.71	8000 A7338
						TE/TXC Models		
					WP423018AFM	Water Pump Cover Gasket	\$1.71	8000 H6125
					WP417018AFM	Water Pump Cover Gasket 2012	\$1.71	8000 A7346
						TE/TXC Models		
					R017V	Water Outlet O-ring	\$0.50	8000 36380
					EC1827018AFM	Intermediate Gear Shaft Gasket	\$3.35	8000 A6954
					WA116	Oil Line Crush Washer 2 Req.	\$3.02	8000 45194
					H3702020S	Cylinder Head Gasket	\$45.39	8000 A6576
						(SP= 0,50 mm)		
					H3702027S	Cylinder Head Gasket	\$45.39	8B00A6576
						(SP= 0,70 mm) Not included in kit		
					B1134010RC	Cylinder Base Gasket	\$9.94	8000 A6577
						<b>Description</b>	<b>List Price</b>	<b>OEM Part#</b>
			<b>Bottom End Kit</b>	<b>List Price</b>	<b>Component Part#</b>			
			w/o crank seals					
			C3512	\$41.95	EC1778032AFM	Outer Clutch Cover Gasket	\$4.54	8000 A6999
					EC1777032AFM	Inner Clutch Cover Gasket	\$19.82	8000 A6997
					EC1780018AFM	Bevel Gear Seat Gasket	\$2.06	8000 A6990
					EC1779	Mag Cover Gasket	\$4.21	8000 A7004
					WA116	Oil Line Crush Washer 2 Req.	\$1.06	8000 45194
					R18X2.5V	Oil Fill Plug O-ring	\$1.71	8000 29171
					OP419032AFM	Oil Pump Gasket	\$1.91	8000 A7061
					R013B	Oil Pipe O-ring 2 Req.	\$1.27	8000 01199
					R017V	Kick Starter O-ring	\$0.50	8000 36380

All Component Parts can be purchased individually.



**WARNING:** Cancer and Reproductive Harm [www.P65Warnings.ca.gov](http://www.P65Warnings.ca.gov)



# MX/Dirt · Off-Road Gaskets



Cometic Gasket - An Exclusive NASCAR Performance® Product

## HUSQVARNA WR250/CR250

Model	Year	Bore Size	Top End Kit	List Price	Component Part#	Component Description	List Price	OEM Part #				
TC250, TE250, TE250i, TE300, TX300	17-19		C3623	\$38.33	WA135	Cylinder Head Crush Washer	\$0.80	56530080000				
					WA133	Water Jacket Crush Seal	\$0.90	603061001				
					R78X2V	Inner Head O-ring 300 Models	\$4.29	770078020				
					R73X2V	Inner Head O-ring	\$3.71	770730020				
					R105X2B	Outer Head O-ring	\$2.57	770105020				
					PV137032AFM	Right Power Valve Cover Gasket	\$5.00	54837008000				
					PV136032AFM	Left Power Valve Gasket	\$4.72	54837006000				
					R112V	Front Exhaust Cover O-Ring	\$1.19	770116241				
					B1384010RC	Cylinder Base Gasket	\$6.25	55430030020				
					B1384018AFM	Cylinder Base Gasket	\$6.25	55430030040				
					B1384020RC	Cylinder Base Gasket	\$6.25	55430030050				
					B1384032AFM	Cylinder Base Gasket	\$6.25	55430030075				
					R16X2V	Exhaust Control O-ring	\$3.02	770160021				
					R15X1.5V	Exhaust Control Flap O-ring	\$1.13	770150151				
					R24X2V	PV Actuator Cover O-ring	\$6.19	770240020				
					R12.5X2.5V	PV Guide Spring	\$2.89	770021120				
					R44X3V	Exhaust O-rings	\$2.82	770440030				
							<b>Oil Seal Kit</b>	<b>List Price</b>	<b>Component Part#</b>	<b>Component Description</b>	<b>List Price #</b>	<b>OEM Part #</b>
							C3623OS	\$56.00	OS141	Output Shaft Seal	\$15.99	0760324571
									OS197	Shift Shaft Seal	\$2.46	0760142460
				OS199	BalancE Shaft Seal	\$17.45	47030076100					
				OS202	Water Pump Shaft Seal	\$7.56	0760082472					
				OS217	Left Crank Seal	\$14.03	0760253570					
				OS264	Right Crank Seal	\$10.97	0760385273					

## HUSQVARNA FC250

Model	Year	Bore Size	Top End Kit	List Price	Component Part#	Component Description	List Price	OEM Part #
FC250	15-19	79mm	C3595-EST	\$71.75	H3698027S	Cylinder Head Gasket	\$33.23	79030036086
					B1301014RC	Cylinder Base Gasket	\$11.87	79230035000
					3186V	Valve Stem Seals 4 Required	\$4.99	77036027000
					R018B	Cam Chain Tensioner O-ring	\$3.92	770180020
					WA145	Cam Chain Tensioner Crush Seal	\$2.16	603242920
					R013V	Cam Chain Tensioner Cap O-ring	\$1.00	770010010
					R023V	Plug Well Cam Tower O-rings	\$1.46	770260015
					EX1333059F	Exhaust Flange Gasket	\$5.05	77236041000

Bottom End Kit w/Oil Seals	List Price	Component Part#	Description	List Price	OEM Part#
C3595BE	\$97.36	WA133	Clutch Cover Crush Seal	\$0.90	0603061001
		WA133	Water Pump Crush Washer	\$0.90	0603061001
		WA135	Clutch Banjo Bolt Crush Washer	\$0.80	0603080161
		R017B	Oil Screen Cover O-ring	\$1.14	0770020170
		R022V	Output Shaft O-ring	\$1.19	0770020220
		R3.5X2B	Oil Squirter O-ring	\$0.38	0770035020
		R014V	Drain Plug O-ring	\$1.08	0770110015
		R19X3V	Fill Plug O-ring	\$3.02	0770191015
		R25X3V	Starter O-ring	\$2.90	0770250030
		R30X1.5V	Slave Cylinder O-Ring	\$2.29	0770300015
		R031V	Oil Pump Cover O-ring	\$4.65	0770440020
		R119B	Crank End O-ring	\$1.04	07700240251
		R9X1.5V	Balance Shaft O-rings	\$2.56	07700900151
		R12.5X2V	Oil Screen O-ring	\$3.74	07701250151
		R028V	Oil Filter Cover O-ring	\$1.19	07703305178
		WA123	RT Case Locating Screw	\$1.96	58030081000
			Crush Washer		
		WA137	Magnetic Plug Crush Washer	\$1.53	58038022000
		WA137	Oil Check Valve Crush Washer	\$1.53	58038022000
		EC2178032AFM	Inner Clutch Cover	\$15.59	79230025000
		EC2181032AFM	Slave Cylinder Gasket	\$4.37	79232065000
		WP504	Water Pump Gasket	\$7.19	79235053000
<b>Oil Seal Kit</b>	<b>List Price</b>	<b>Component Part#</b>	<b>Component Description</b>	<b>List Price</b>	<b>OEM Part #</b>
C3595OS	\$36.69	OS269	Oil Pump Seal	\$1.48	0760142450
		OS197	Shift Shaft Seal	\$2.46	0760142460
		OS391	Mag Seal	\$10.73	0760304760
		OS390	Output Shaft Seal	\$3.05	0760324571
		OS392	Primary Side Oil Seal	\$12.99	0760405561
		OS393	Balance Shaft/Water Pump Seals	\$5.03	07601530451
<b>Clutch &amp; Mag Kit</b>	<b>List Price</b>	<b>Component Part#</b>	<b>Component Description</b>	<b>List Price</b>	<b>OEM Part #</b>
C3595CM	\$20.98	R0079	Outer Clutch Cover	\$8.99	79230027000
		EC2177032AFM	Mag Cover Gasket	\$11.99	79230040000



**WARNING:** Cancer and Reproductive Harm www.P65Warnings.ca.gov





# MX/Dirt • Off-Road Gaskets



Cometic Gasket - An Exclusive NASCAR Performance® Product

## HUSQVARNA FC350

Model	Year	Bore Size	Top End Kit	List Price	Component Part#	Component Description	List Price	OEM Part #
FC350	15-19	88mm	C3605-EST	\$60.84	H3093SP4032S	Cylinder Head Gasket	\$33.23	79230036086
					B1301014RC	Cylinder Base Gasket	\$11.87	79230035000
					3231V	Valve Stem Seals 4 Required	\$6.48	77236027000
					R018B	Cam Chain Tensioner O-ring	\$1.71	770180020
					WA145	Cam Chain Tensioner Crush Seal	\$2.16	603242920
					R013B	Cam Chain Tensioner Cap O-ring	\$1.19	770010010
					R023V	Plug Well Cam Tower O-rings	\$1.46	770260015
					R9X1.5V	Oil Galley O-rings 9x1.5	\$2.56	7700900151
					EX1333059F	Exhaust Flange Gasket	\$5.05	77236041000

Bottom End Kit w/Oil Seals	List Price	Component Part#	Component Description	List Price #	OEM Part #
C3595BE	\$97.36	WA133	Clutch Cover Crush Seal	0.9	603061001
		WA133	Water Pump Crush Washer	0.9	603061001
		WA135	Clutch Banjo Bolt Crush Washer	\$0.80	603080161
		R017B	Oil Screen Cover O-ring	\$1.14	770020170
		R022V	Output Shaft O-ring	\$1.19	770020220
		R3.5X2B	Oil Squirter O-ring	\$0.38	770035020
		R014V	Drain Plug O-ring	\$1.08	770110015
		R19X3V	Fill Plug O-ring	\$3.02	770191015
		R25X3V	Starter O-ring	\$2.90	770250030
		R30X1.5V	Slave Cylinder O-Ring	\$2.29	770300015
		R031V	Oil Pump Cover O-ring	\$4.65	770440020
		R119B	Crank End O-ring	\$1.04	7700240251
		R9X1.5V	Balance Shaft O-rings	\$2.56	7700900151
		R12.5X2V	Oil Screen O-ring	\$3.74	7701250151
		R028V	Oil Filter Cover O-ring	\$1.19	7703305178
		WA123	Right Case Locating Screw	\$1.96	58030081000
			Crush Washer		
		WA137	Magnetic Plug Crush Washer	\$1.53	58038022000
		WA137	Oil Check Valve Crush Washer	\$1.53	58038022000
		EC2178032AFM	Inner Clutch Cover	\$15.59	79230025000
		EC2181032AFM	Slave Cylinder Gasket	\$4.37	79232065000
		WP504	Water Pump Gasket	\$7.19	79235053000

  

Oil Seal Kit	List Price	Component Part#	Component Description	List Price	OEM Part #
C3595OS	\$36.69	OS269	Oil Pump Seal	\$1.48	760142450
		OS197	Shift Shaft Seal	\$2.46	760142460
		OS391	Mag Seal	\$10.73	760304760
		OS390	Output Shaft Seal	\$3.05	760324571
		OS392	Primary Side Oil Seal	\$12.99	760405561
		OS393	Balance Shaft Seal/	\$5.03	7601530451
			Water Pump Seals		

Clutch & Mag Kit	List Price	Component Part#	Component Description	List Price	OEM Part #
C3595CM	\$20.98	R0079	Outer Clutch Cover	\$8.99	79230027000
		EC2177032AFM	Mag Cover Gasket	\$11.99	79230040000

## HUSQVARNA WR/CR 360

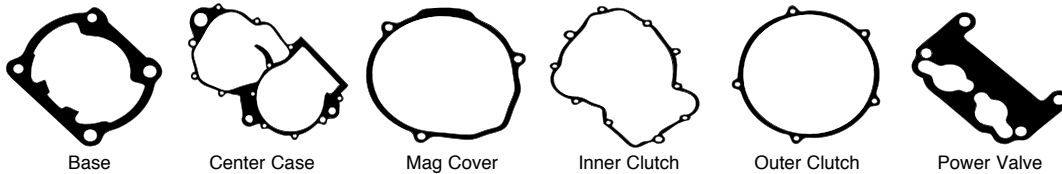

Model	Year	Bore Size	Top End Kit	List Price	Component Part#	Component Description	List Price	OEM Part #
WR360	99-03	O-Ring	C7745	\$25.83	R043V	Inner Head O-Ring	\$3.00	5410932
CR360	99				R158B	Outer Head O-Ring	\$3.77	
					B0465018AFM	Base Gasket	\$8.36	
					PV096018AFM	Power Valve Gasket	\$5.68	8000 73443
						Description	List Price	OEM Part#
			Bottom End Kit w/o crank seals					
			C3375	\$44.62	R165B	Clutch Cover O-ring	\$3.92	8000 86878
					EC453032AFM	Inner Clutch Gasket	\$18.29	
					EC452060AFM	Mag Cover Gasket	\$7.97	
					EC451020F	Center Case Gasket	\$12.39	8000 72522



# MX/Dirt • Off-Road Gaskets



Cometic Gasket - An Exclusive NASCAR Performance® Product

## HUSQVARNA TE410E

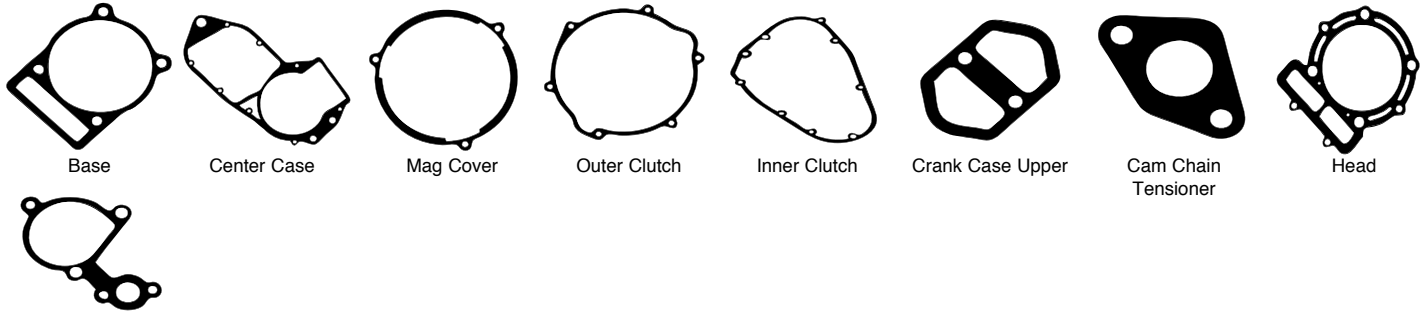

Model	Year	Bore Size	Top End Kit	List Price	Component Part#	Component Description	List Price	OEM Part #			
TE410E	99-01	95 mm	C7730	\$36.35	H0974059F	95mm Head Gasket	\$20.58	161536001			
TE/TC 410	99-00				B0431043F	Base gasket	\$11.41	161540702			
					EC409012F	Cam Chain Tensioner Gasket	\$4.75	161535801			
					EC408015F	Upper Crankcase Gasket	\$3.80	161503601			
						<b>Bottom End Kit w/o crank seals</b>					
					C3376	\$40.57					
							EC407032AFM	Left Inner Cover Gasket	\$4.75	161165003	
							EC406060AFM	Left Outer Cover Gasket	\$12.56	8000608191	
							EC405032AFM	Right Cover Gasket	\$9.11	161527501	
							EC1820020F	Center Case Gasket	\$17.84	161501403	
				WP093032AFM	Water Pump Gasket	\$7.44	8A00063644				
FC450	16	95mm	C3604-EST	\$61.31		<b>Component Description</b>	<b>List Price</b>	<b>OEM Part #</b>			
FE450	17-18				R10X2V	Temp. Sensor O-ring	\$1.59	770100020			
					R017B	Oil Filter Screen O-ring 17x1.78	\$1.14	770020170			
					R15X1.5V	Rocker Arm O-rings 15,00X1,50	\$1.13	770150151			
					R031V	Oil Pump Cover O-ring	\$4.65	770440020			
					3225V	Valve Seal	1.63	59036027000			
					R9950	EX-C Exhaust Valve Seal Pack	10.92	77036027000			
					EC495018AFM	Cam Chain Tensioner Gasket	\$3.80	59036003050			
					EX1589059F	Exhaust Gasket	\$8.68	78036041000			
					H4207036S	Cylinder Head Gasket	\$46.33	79430036010			
					B1323014RC	Cylinder Base Gasket	\$9.94	79430035000			
						<b>Component Description</b>	<b>List Price</b>	<b>OEM Part #</b>			
TE/TC610	99-08				99 mm	C7732	\$77.91	H0923059F	99mm Head Gasket	\$27.41	800064726
SM610R	00-08							B0431043F	Base Gasket	\$11.41	161540702
TE/TC610	99-00							EC409012F	Cam Chain Tensioner Gasket	\$4.75	161535801
TE610E	99-04	EC408015F	Upper Crankcase Gasket	\$3.80				161503601			
			<b>Bottom End Kit w/o crank seals</b>								
		C3376	\$42.19								
				EC407032AFM	Left Inner Cover Gasket	\$4.75	161165003				
				EC406060AFM	Left Outer Cover Gasket	\$12.56	8000608191				
				EC405032AFM	Right Cover Gasket	\$9.11	161527501				
				EC1820020F	Center Case Gasket	\$17.84	161501403				
				WP093032AFM	Water Pump Gasket	\$7.44	8A00063644				

## KAWASAKI KDX50

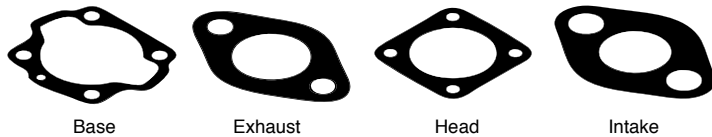

Model	Year	Bore Size	Top End Kit	List Price	Component Part#	Component Description	List Price	OEM Part #
KDX50	03-05	43 mm	C7014	\$19.14	H1281020RC	Head Gasket 43mm Bore	\$6.25	11004-S004
					B0543020RC	Base Gasket	\$6.02	11061-S041
					EX349042AM	Exhaust Gasket	\$3.58	11061-S081
					IR417020F	Intake Gasket	\$1.71	11061-S042

All Component Parts can be purchased individually.

**WARNING:** Cancer and Reproductive Harm www.P65Warnings.ca.gov



# MX/Dirt • Off-Road Gaskets



Cometic Gasket - An Exclusive NASCAR Performance® Product

## KAWASAKI KX60

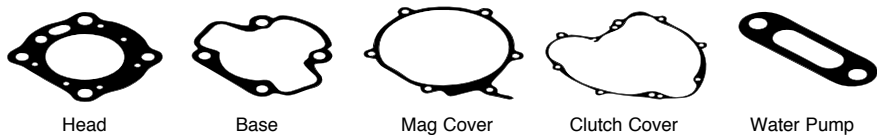

Model	Year	Bore Size	Top End Kit	List Price	Component Part#	Component Description	List Price	OEM Part #
KX60	85-03	45 mm	C7154	\$22.99	H0262043F	Head Gasket 45mm	\$17.38	11004-1218
		48 mm	C7605	\$22.99	H0520043F	Head Gasket 48mm	\$17.38	11004-1218
		53 mm	C7606	\$22.99	H0692043F	Head Gasket 53mm	\$17.38	11004-1218

Bottom End Kit w/Oil Seals	List Price	Component Part#	Component Description	List Price	OEM Part #
C7154BE	\$49.00	WP0500032AFM	Water Elbow Outlet	\$2.44	11009-1952
		R222V	Water Pump Body O-ring	\$2.25	670B3039
		R013B	Output Shaft O-ring	\$1.19	92055-022
		R9X2V	Clutch Pushrod O-ring	\$1.59	670B1509
		WA107	Drain Plug Seal	\$2.74	92065-058
		WA107	Trans Fluid Drain Plug	\$2.74	92065-058
		OS110	Crank Seal 20x40x7	\$9.47	92049-1188

Oil Seal Kit	List Price	Component Part#	Component Description	List Price	OEM Part #
C7736OS	\$40.64	OS131	Output Shaft Seal 25x37x6	\$7.10	92050-013
		OS331	Shift Shaft Seal 13x22x5.5	\$3.71	92051-005
		OS366	Start Shaft Seal 16x24x4	4.07	92049-002
		OS361	Water Pump Shaft Seal 8x18x10	\$9.43	92049-1366

Clutch & Mag Kit	List Price	Component Part#	Component Description	List Price	OEM Part #
C7736CM	\$17.38	C7494	Clutch Cover Gasket	\$8.91	11009-1976
		EC274032AFM	Mag Cover Gasket	\$8.69	11009-1974

## KAWASAKI KX65

Model	Year	Bore Size	Top End Kit	List Price	Component Part#	Component Description	List Price	OEM Part #
KX65	00-19	45 mm	C7736	\$22.99	H0970010S	Head Gasket 45mm	\$18.56	11004-1346
		47 mm	C7682	\$22.99	H0971010S	Head Gasket 47mm	\$18.56	11004-1346
		48 mm	C7737	\$22.99	H0972010S	Head Gasket 48mm	\$18.56	11004-1346

Bottom End Kit w/Oil Seals	List Price	Component Part#	Component Description	List Price	OEM Part #
C7736BE	\$47.57	WP104018AFM	Water Pump Gasket	\$2.16	K1106-01924
		WP105018AFM	Water Outlet Gasket	\$2.16	K1106-01927
		WA118	Water Pump Drain Crush Washer	\$1.88	KK920-22077
		R013B	Output Shaft O-rings	\$1.19	KK920-55022
		WA108	Drain Plug Gasket	\$2.56	KK920-65058

Oil Seal Kit	List Price	Component Part#	Component Description	List Price	OEM Part #
C7736OS	\$40.64	OS360	Water Pump Seal Outer	\$5.31	K9204-91359
		OS361	Water Pump Seal Inner	\$9.43	K9204-91366
		OS365	Clutch Actuator Seal	\$2.50	K9204-91414
		OS366	Kickstart Seal	\$4.07	KK920-49002
		OS131	Output Shaft Seal	\$7.10	KK920-50013
		OS331	Shift Shaft Seal	\$3.71	KK920-51005

Clutch & Mag Kit	List Price	Component Part#	Component Description	List Price	OEM Part #
C7736CM	\$17.38	EC274018AFM	Mag Cover Gasket	\$8.69	K1100-91974
		C3078	Inner Clutch (Primary) Gasket	\$9.37	K1106-01925
					K1106-10121



# MX/Dirt • Off-Road Gaskets



Cometic Gasket - An Exclusive NASCAR Performance® Product

## KAWASAKI KX80

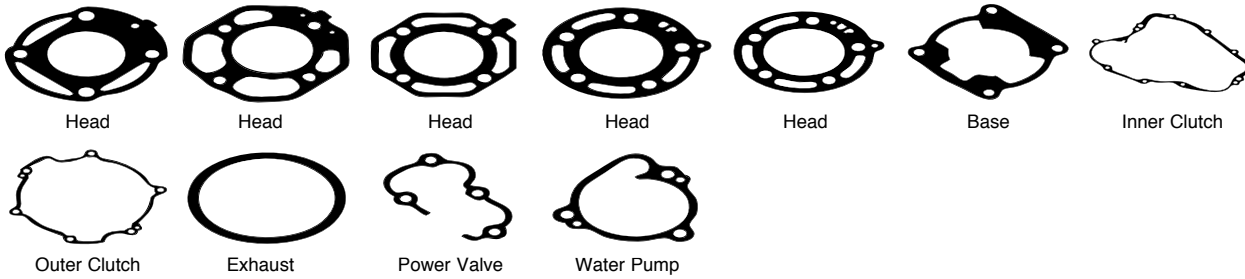

Model	Year	Bore Size	Top End Kit	List Price	Component Part#	Component Description	List Price	OEM Part #
KX80 EZ	83-85	50 mm	C7027	\$22.99	H0025043F	Head Gasket 50mm	\$22.32	11004-1058
					B0028020F	Base Gasket	\$4.65	11009-1975
					R221V	Exhaust O-Ring 2 Req	\$3.92	670E3036
					<b>Crank Seal Kit</b>		<b>List Price</b>	<b>Component Part#</b>
			C7656	\$16.99	OS110	20X40X7 Oil Seal 2 Req	\$9.47	92049-1188
KX80 G1, G2	86-87	50 mm	C7029	\$22.99	H0026043F	Head Gasket 50mm	\$14.87	11004-1138
					H0447043F	Head Gasket 53mm	\$21.76	
		53 mm	C7318	\$22.99	B0029018AFM	Base Gasket	\$7.16	11009-1970
					R221V	Exhaust O-Ring 2 Req	\$3.92	670E3036
<b>Bottom End Kit w/Oil Seals</b>		<b>List Price</b>	<b>Component Part#</b>	<b>Component Description</b>	<b>List Price</b>	<b>OEM Part #</b>		
			C7029BE	\$49.44	R9X2V	Clutch Linkage O-ring	\$1.59	670B1509
					WA107	Drain Plug Gasket	\$2.74	92065-058
					WP036018AFM	Water Pump Gasket	\$3.74	11009-1972
					WA118	Drain Plug Gasket	\$1.88	92022-077
					R013B	Output Shaft O-ring	\$1.19	92055-022
<b>Oil Seal Kit</b>		<b>List Price</b>	<b>Component Part#</b>	<b>Component Description</b>	<b>List Price</b>	<b>OEM Part #</b>		
			C7029OS	\$40.64	OS110	Left & Right Crank Seals	\$9.47	92049-1188
					OS131	Output Shaft Seal	\$7.10	92050-013
					OS331	Shift Shaft Seal	\$3.71	92051-005
					OS366	Start Shaft Seal	4.07	92049-002
					OS361	Water Pump Oil Seal	\$9.43	92049-1366
<b>Clutch &amp; Mag Kit</b>		<b>List Price</b>	<b>Component Part#</b>	<b>Component Description</b>	<b>List Price</b>	<b>OEM Part #</b>		
			C7029CM	\$17.38	EC190018AFM	Clutch Cover Gasket	\$8.69	11061-0122
					EC274018AFM	Mag Cover Gasket	\$8.69	11009-1974
<b>Crank Seal Kit</b>		<b>List Price</b>	<b>Component Part#</b>	<b>Component Description</b>	<b>List Price</b>	<b>OEM Part #</b>		
			C7656	\$16.99	OS110	20X40X7 Oil Seal 2 Req	\$9.47	92049-1188
KX80 L1, L2, L3	88-90	50 mm	C7030	\$22.99	H0027043F	Head Gasket 50mm	\$14.87	11004-1168
					H0448043F	Head Gasket 53mm	\$14.87	
		53 mm	C7319	\$22.99	B0029018AFM	Base Gasket	\$7.16	11009-1533
					R221V	Exhaust O-Ring 2 Req	\$3.92	670E3036
<b>Crank Seal Kit</b>		<b>List Price</b>	<b>Component Part#</b>	<b>Component Description</b>	<b>List Price</b>	<b>OEM Part #</b>		
			C7656	\$16.99	OS110	20X40X7 Oil Seal 2 Req	\$9.47	92049-1188
KX80	91-97	49 mm	C7031	\$22.99	H0271010S	Head Gasket 49mm	\$14.87	11004-1213
					H0441010S	Head Gasket 50mm	\$14.87	
		50 mm	C7307	\$22.99	B0029018AFM	Base Gasket	\$7.16	11009-1970
					B0029012F	High Compression Base Gasket	\$7.16	
<b>Bottom End Kit w/crank seals</b>		<b>List Price</b>	<b>Component Part#</b>	<b>Component Description</b>	<b>List Price</b>	<b>OEM Part #</b>		
			C3345	\$31.99	R221V	Exhaust O-Ring 2 Req	\$3.92	670E3036
					EC191018AFM	Mag Cover Gasket	\$8.69	11009-1973
					C7493	Inner Clutch Cover Gasket	\$8.69	11009-1971
					WP036018AFM	Water Pump Gasket	\$3.74	11009-1972
<b>Crank Seal Kit</b>		<b>List Price</b>	<b>Component Part#</b>	<b>Component Description</b>	<b>List Price</b>	<b>OEM Part #</b>		
			C7656	\$16.99	OS110 20X40X7	20X40X7 Oil Seal 2 Req	\$9.47	92049-1188

All Component Parts can be purchased individually.

**WARNING:** Cancer and Reproductive Harm www.P65Warnings.ca.gov





# MX/Dirt • Off-Road Gaskets



Cometic Gasket - An Exclusive NASCAR Performance® Product

## KAWASAKI KX80/85

Model	Year	Bore Size	Top End Kit	List Price	Component Part#	Component Description	List Price	OEM Part #			
KX80	98-00	49 mm	C7391	\$22.91	H0271010S	Head Gasket	\$14.87	11004-1213			
					B0311018AFM	Base Gasket	\$4.65	11060-1779			
			Bottom End Kit w/crank seals	C3345	\$31.99	EC191018AFM	Mag Cover Gasket	\$8.69	11009-1973		
						C7493	Inner Clutch Cover Gasket	\$8.91	11009-1971		
			Crank Seal Kit	C7656	\$16.99	WP036018AFM	Water Pump Cover Gasket	\$3.74	11009-1972		
						OS110	20X40X7 Oil Seal 2 Req	\$9.47	92049-1188		
			KX85	01-13	48.5 mm	C3501	\$25.55	H11020SP1010S	Head Gasket 48.5mm	\$14.87	11004-1360
						50.5 mm	C7859	\$25.55	B0311018AFM	Base Gasket	\$4.65
					Bottom End Kit w/Oil Seals	C3501BE	\$76.10	B0311012F	High Compression Base Gasket	\$6.25	11060-1779
								EX297063C	Exhaust Gasket	\$4.37	11060-1842
Oil Seal Kit	C3501OS	\$48.66			PV066018AFM	KIPS Cover Gasket	\$3.80	11060-1778			
					R126V	Exhaust O-Ring 2 Req	\$1.19	671E2535			
KX85	14-19	48.5 mm			C3541	\$25.55	H3880012S	Head Gasket 48.5mm Bore	14.87	11004-0737	
					50.5 mm	C3634	\$25.55	B0311018AFM	Base Gasket	4.65	11060-1779
		Bottom End Kit w/Oil Seals			C3501BE	\$76.10	B0311012F	High Compression Base Gasket	6.25	11060-1779	
							EX297063C	Exhaust Gasket	4.37	11060-1842	
		Oil Seal Kit	C3501OS	\$48.66	PV145018AFM	Front Power Valve Gasket	4.72	11061-0889			
					PV066018AFM	KIPS Cover Gasket	3.80	11060-1778			
		Clutch & Mag Kit	C3501CM	\$17.39	R219V	Exhaust O-Ring 2 Req	3.92	670E3034			
					EC190018AFM	Inner Clutch Cover Gasket	\$8.69	11061-0122			
		Bottom End Kit w/Oil Seals	C3501BE	\$76.10	WA124	Drain Plug Gasket	\$2.22	92022-077			
					WA107	Trans Drain Plug	\$2.74	92065-058			
Oil Seal Kit	C3501OS	\$48.66	WP036018AFM	Water Pump Gasket	\$3.74	11061-0184					
			R013B	Output Shaft O-rings 17.5X1.5	\$1.19	92055-022					
Clutch & Mag Kit	C3501CM	\$17.39	OS110	Crank Seals 20x40x7	\$9.47	92049-1188					
			OS131	Output Shaft Seal 25x37x5	\$7.10	92049-1292					
Bottom End Kit w/Oil Seals	C3501BE	\$76.10	OS331	Shift Shaft Seal 13x22x5.5	\$3.71	92051-005					
			OS361	Water Pump Shaft Seal 8X18X10	\$9.43	92049-1366					
Oil Seal Kit	C3501OS	\$48.66	OS366	Kickstart Shaft Seal 16x24x4	\$4.07	92049-002					
			OS306	Power Valve Shaft Seal	\$2.91	92049-1262					
Clutch & Mag Kit	C3501CM	\$17.39	OS365	Clutch Actuator Shaft Seal	\$2.50	92049-1414					
			EC513018AFM	Clutch Cover Gasket	\$9.94	11061-0869					
Bottom End Kit w/Oil Seals	C3501BE	\$76.10	EC191018AFM	Mag Cover Gasket	\$8.69	11061-0194					

## KAWASAKI KX100

Model	Year	Bore Size	Top End Kit	List Price	Component Part#	Component Description	List Price	OEM Part #
KX100	95-97	53 mm	C7268	\$35.72	H0342010S	Head Gasket 53mm	\$20.99	11004-1214
			54.5 mm	C7347	\$35.72	H0490010S	Head Gasket 54.5mm	\$20.99
KX100	98-13	53 mm	C7392	\$35.72	B0029018AFM	Base Gasket	\$7.16	11009-1970
					R221V	Exhaust O-Ring 2 Req	\$3.92	670E3036
		54.5 mm	C7413	\$35.72	H0342010S	Head Gasket 53mm	\$20.99	11004-1214
					H0490010S	Head Gasket 54.5mm	\$20.99	
		Bottom End Kit w/Oil Seals	C3501BE	\$76.10	B0311018AFM	Base Gasket	\$4.65	11060-1779
					B0311012F	High Compression Base Gasket	\$6.25	11060-1779
		Oil Seal Kit	C3501OS	\$48.66	EX297063C	Exhaust Gasket	\$4.37	11060-1842
					PV066018AFM	KIPS Cover Gasket	\$3.80	11060-1778
		Clutch & Mag Kit	C3501CM	\$17.39	WA128	Head Bolt Washer 5 Req	\$1.59	92022-304
					R126V	Exhaust O-Ring 2 Req	\$1.19	670E3036



# MX/Dirt · Off-Road Gaskets



Cometic Gasket - An Exclusive NASCAR Performance® Product

## KAWASAKI KX100

Model	Year	Bore Size	Top End Kit	List Price	Component Part#	Component Description	List Price	OEM Part #	
KX100	14-16	52.5 mm	C3542	\$25.55	H3881012S	Cylinder Head Gasket	\$14.87	11004-0739	
		54.5 mm	C3543	\$25.55	H3881SP1012S	Cylinder Head Gasket 54.5 112cc MOD	\$14.87		
	95-16					PV145018AFM	Power Valve Cover Gasket	\$4.72	11061-0889
						PV066018AFM	Right Power Valve Cover Gasket	\$3.80	11060-1778
						B0311018AFM	Base Gasket	\$4.65	11060-1779
						WA128	Cyl Head Water Jacket Seal	\$1.59	92022-304
						R219V	Exhaust Gasket	\$3.92	670E3034KX100
							<b>Bottom End Kit w/Oil Seals</b>		
						C3501BE	\$76.10		
							<b>Oil Seal Kit</b>		
				C3501OS	\$48.66				
					<b>Clutch &amp; Mag Kit</b>				
				C3501CM	\$17.39				

## KAWASAKI KLX110

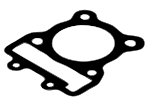

Head

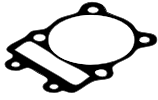

Base



Intake

Model	Year	Bore Size	EST Top End Kit	List Price	Component Part#	Component Description	List Price	OEM Part #	
KLX110	03-19	55 mm	C7939-EST	\$41.68	H1891010S	Head Gasket 55mm	\$18.56	11004-1338	
		57 mm	C7949-EST	\$41.68	H1917010S	Head Gasket 57mm	\$18.56	11004-1338	
					B0678SP2020RC	Base Gasket	\$9.94	11060-1796	
					IR431018AFM	Intake Gasket	\$2.33	K1106-01753	
					R022B	Intake O-rings 2 Req.	\$1.13	K9205-51527	
					EX781	Exhaust Gasket	\$3.35	K1106-11112	
					R110B	Cam Chain Tensioner Bolt O-ring	\$1.13	KK670-D2010	
					R117B	Cam Chain Tensioner O-ring	\$0.42	KK670-D2021	
					3183V	Valve Seals	\$5.50	K9204-91349	
					R91X2.5V	Cam Cover O-ring	\$7.36	K9205-51527	
					R031B	Tappet Cover O-rings 2 Req.	\$4.65	K9205-51231	
						<b>Component Part#</b>	<b>Component Description</b>	<b>List Price</b>	<b>OEM Part #</b>
					EC1102018AFM	Clutch Cover Gasket	\$5.91	11061-0131	

## KAWASAKI KLX125



Head



Cam Chain Tensioner

Model	Year	Bore Size	Top End Kit	List Price	Component Part#	Component Description	List Price	OEM Part #
KLX125	03-06	59 mm	C7835	\$29.11	H1892027S	Head Gasket 59mm	\$18.56	11004-S003
		61 mm	C3109	\$29.11	H1926027S	Head Gasket 57mm	\$18.56	11004-S003
					B0679020F	Base Gasket	\$6.25	11061-S035
					EC824032AFM	Timing Chain Tensioner Gasket	\$3.07	11061-S038
					R216B	Valve Cap Cover O-Ring 2 Req	\$3.74	92055-S036
					R010B	Cam Chain Bolt O-ring	\$0.62	95055-S032

All Component Parts can be purchased individually.

**WARNING:** Cancer and Reproductive Harm www.P65Warnings.ca.gov



Cometic Gasket - An Exclusive NASCAR Performance® Product

## KAWASAKI KX125

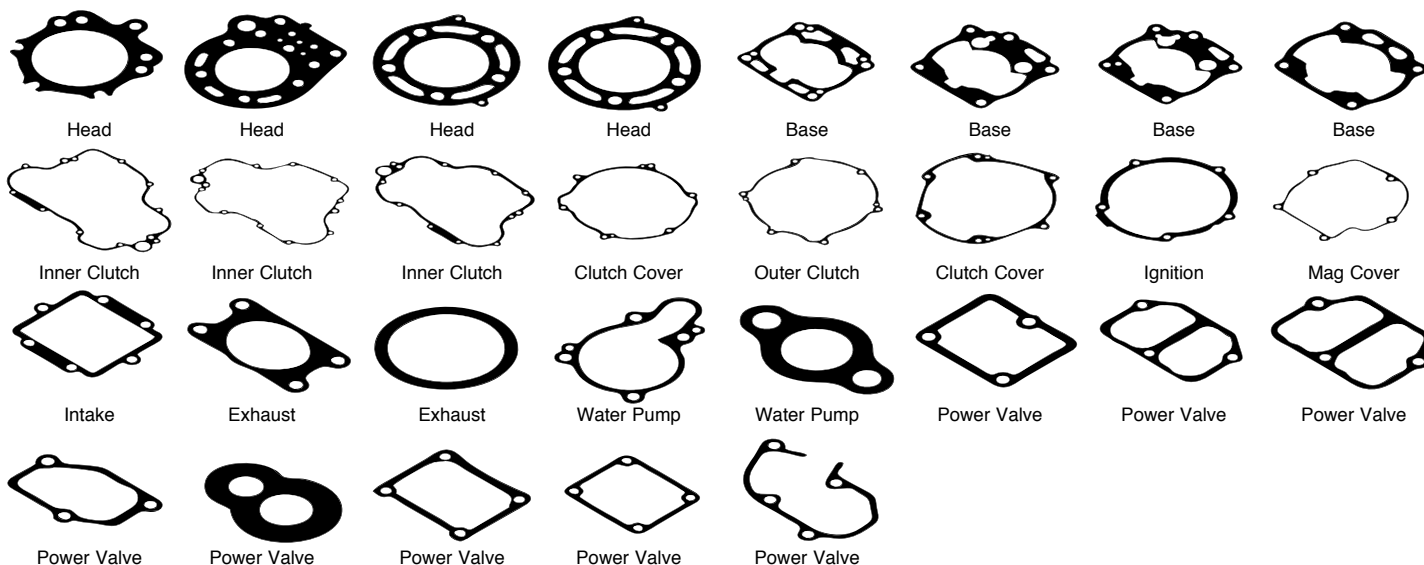

Model	Year	Bore Size	Top End Kit	List Price	Component Part#	Component Description	List Price	OEM Part #
KX125	78-79	57 mm	C7130	\$22.83	H0165020C	Head Gasket 57mm	\$19.99	11004-1006
					B0108020F	Base Gasket	\$5.34	11009-1042
KX125	80-81	57 mm	C7131	\$20.44	H0164043F	Head Gasket 57mm	\$17.38	11004-1023
					B0108020F	Base Gasket	\$5.34	11009-1175
KX125	82-83	58 mm	C7109	\$20.44	H0029043F	Head Gasket 58mm	\$17.38	11004-1048
					B0024020F	Base Gasket	\$5.34	11009-1258
KX125	84	58 mm	C7110	\$20.44	H0248043F	Head Gasket 58mm	\$17.38	11004-1112
					B0024020F	Base Gasket	\$5.34	11009-1258
KX125 D1, E1, E2	85-86	58 mm	C7032	\$32.82	H0021043F	Head Gasket 58mm	\$17.38	11004-1160
					B0024020F	Base Gasket	\$5.34	11009-1258
					I R007018AFM	Intake Gasket	\$3.80	11009-1941
					PV053020F	Left Side Power Valve	\$3.80	11009-1478
					PV054060AFM	Right Side Power Valve	\$3.80	11009-1479
					R224V	Exhaust O-Ring 2 Req	\$1.19	670E3045
					Crank Seal Kit C7698	List Price	Component Part#	Component Description
	\$25.65	OS110 20X40X7	20X40X7 Oil Seal 2 Req	\$9.47	92049-1052			
KX125	87	58 mm	C7119	\$35.72	R223V	Exhaust O-Ring 2 Req	\$3.92	670E3039
					PV054060AFM	Right Power Valve Gasket	\$3.80	11009-1479
					PV052020F	Left Power Valve Gasket	\$3.80	11009-1641
					IR007018AFM	Intake Gasket	\$3.80	11009-1941
					H0021043F	Head Gasket 58mm	\$17.38	11004-1160
					B0024020F	Base Gasket	\$5.34	11009-1258
KX125 F1	88	58 mm	C7033	\$35.72	H0030043F	Head Gasket 58mm	\$17.38	11004-1188
					B0030020F	Base Gasket	\$5.34	11009-1940
					IR007018AFM	Intake Gasket	\$3.80	11009-1941
					PV009018AFM	Left Power Valve Gasket	\$3.80	11009-1938
					PV010020F	Right Power Valve Gasket	\$3.80	11009-1934
					R223V	Exhaust O-Ring 2 Req	\$3.92	670E3039
					Crank Seal Kit C7657	List Price	Component Part#	Component Description
	\$16.99	OS112	Right Oil Seal	\$10.68	92049-1301			
		OS111	Left Oil Seal	\$8.29	92049-1300			

All Component Parts can be purchased individually.



**WARNING:** Cancer and Reproductive Harm [www.P65Warnings.ca.gov](http://www.P65Warnings.ca.gov)



# MX/Dirt · Off-Road Gaskets



Cometic Gasket - An Exclusive NASCAR Performance® Product

## KAWASAKI KX125 G1

Model	Year	Bore Size	Top End Kit	List Price	Component Part#	Component Description	List Price	OEM Part #		
KX125 G1	89-91	58 mm	C7034	\$35.72	H0031043F	Head Gasket	\$17.38	11004-1188		
					B0030020F	Base Gasket	\$5.34	11009-1690		
					IR007018AFM	Intake Gasket	\$3.80	11009-1263		
					PV009018AFM	Front Power Valve Gasket	\$3.80	11009-1691		
					PV010020F	Left Side Power Valve	\$3.80	11009-1692		
					R223V	Exhaust O-Ring 2 Req	\$3.92	670E3039		
					<b>Crank Seal Kit</b>	<b>List Price</b>	<b>Component Part#</b>	<b>Component Description</b>	<b>List Price</b>	<b>OEM Part #</b>
					C7657	\$16.99	OS112	Right Oil Seal	\$10.68	92049-1301
							OS111	Left Oil Seal	\$8.29	92049-1300
KX125 H, H1	89-91	58 mm	C7035	\$35.72	H0032010S	Head Gasket 58mm	\$17.38	11004-1204		
					B0030020F	Base Gasket	\$5.34	11009-1824		
					IR007018AFM	Intake Gasket	\$3.80	11009-1941		
					PV010020F	Left Side Power Valve	\$3.80	11009-1692		
					PV009018AFM	Front Power Valve Gasket	\$3.80	11009-1691		
					R223V	Exhaust O-Ring 2 Req	\$3.92	670E3039		
					<b>Crank Seal Kit</b>	<b>List Price</b>	<b>Component Part#</b>	<b>Component Description</b>	<b>List Price</b>	<b>OEM Part #</b>
					C7657	\$16.99	OS112	Right Oil Seal	\$10.68	92049-1301
							OS111	Left Oil Seal	\$8.29	92049-1300
KX125	92	56 mm	C7117	\$35.72	H0251010S	Head Gasket 56mm	\$17.38	11004-1231		
					B0031020F	Base Gasket	\$5.34	11060-1188		
					IR007018AFM	Intake Gasket	\$3.80	11009-1941		
					PV009018AFM	Front Power Valve Gasket	\$3.80	11009-1934		
					PV011020F	Right Side Power Valve Gasket	\$3.80	11060-1187		
					R223V	Exhaust O-Ring 2 Req	\$3.92	670E3039		
					R018B	Case Galley O-ring	\$3.92	92055-086		
					WA107	Drain Plug Crush Washer	\$2.74	92065-058		
					IR007018AFM	Reed Valve Gasket	\$3.80	11009-1941		
					R018B	Primary Gear O-ring	\$3.92	92055-086		
					WP030018AFM	Water Pump Elbow Gasket	\$1.93	11009-1935		
					WP037018AFM	Water Pump Cover Gasket	\$3.74	11009-1936		
					WA118	Water Pump Drain Plug	\$1.88	92022-304		
						Crush Washer				
						R5.5X1.5B	Impeller O-ring	\$2.19	92055-1343	
						EC270032AFM	Primary Gasket	\$16.13	11060-1190	
						R018B	Primary O-ring	\$3.92	92055-086	
						R013B	Output Shaft Backup Ring	\$1.19	92055-022	
					<b>Oil Seal Kit</b>	<b>List Price</b>	<b>Component Part#</b>	<b>Component Part#</b>	<b>List Price</b>	<b>OEM Part#</b>
					C7117OS	\$35.72	OS111	Left Crank Seal	\$8.29	92049-1300
							OS112	Right Crank Seal	\$10.68	92049-1301
							OS131	Output Shaft Seal 25x37x5	\$7.10	92050-013
							OS306	Clutch Pushrod Seal	\$2.91	92049-1262
							OS308	Start Shaft Seal 16x24x4	\$5.89	92049-002
							OS331	Shift Shaft Seal	\$3.71	92051-005
							OS360	Outer Water Pump Seal	\$5.31	92049-1359
								8x18x3.5		
							OS361	Inner Water Pump Seal 8x18x10	\$9.43	92049-1366
							OS362	Power Valve Governor Seal	\$4.51	92049-1207
								8x14x4		
<b>Clutch &amp; Mag Kit</b>	<b>List Price</b>	<b>Component Part#</b>	<b>Component Description</b>	<b>List Price #</b>	<b>Oem Part #</b>					
C7117CM	\$16.13	EC199018AFM	Mag Cover Gasket	\$7.44	11060-1189					
		EC230018AFM	Clutch Cover Gasket	\$8.69	11060-1191					

All Component Parts can be purchased individually.

**WARNING:** Cancer and Reproductive Harm [www.P65Warnings.ca.gov](http://www.P65Warnings.ca.gov)





# MX/Dirt • Off-Road Gaskets



Cometic Gasket - An Exclusive NASCAR Performance® Product

## KAWASAKI KX125

Model	Year	Bore Size	Top End Kit	List Price	Component Part#	Component Description	List Price	OEM Part #			
KX125	93-94	56 mm	C7133	\$35.72	H0251010S	Head Gasket 56mm	\$17.38	11004-1252			
					B0031020F	Base Gasket	\$5.34	11060-1188			
					IR007018AFM	Intake Gasket	\$3.80	11009-1941			
					PV067018AFM	Power Valve Rod Gasket	\$3.80	11060-1346			
					PV043018AFM	Front Power Valve Gasket	\$3.80	11060-1194			
					PV011020F	Right Power Valve Gasket	\$3.80	11060-1187			
					WP030018AFM	Water Inlet Gasket	\$1.93	11009-1935			
					R223V	Exhaust O-Ring 2 Req	\$3.92	670E3039			
						<b>Clutch &amp; Mag Kit</b>	<b>List Price</b>	<b>Component Part#</b>	<b>Component Description</b>	<b>List Price</b>	<b>OEM Part #</b>
						C7117CM	\$16.13	EC198018AFM	Outer Clutch Cover Gasket	\$8.69	11060-1351
								EC199018AFM	Mag Cover Gasket	\$7.44	11060-1189
						<b>Crank Seal Kit</b>	<b>List Price</b>	<b>Component Part#</b>	<b>Component Description</b>	<b>List Price</b>	<b>OEM Part #</b>
						C7657	\$16.99	OS112	Right Side Oil Seal	\$10.68	92049-1301
								OS111	Left Oil Seal	\$8.29	92049-1300
KX125	95-97	56 mm	C7241	\$35.72	H0251010S	Head Gasket 56mm	\$17.38	11004-1252			
					H0410010S	Head Gasket 58mm	\$17.38				
		58 mm	C7297	\$35.72	B0181018AFM	Base Gasket	\$5.34	11060-1647			
					B0181012F	High Compression Base Gasket	\$5.34				
					IR007018AFM	Intake Gasket	\$3.80	11009-1941			
					R223V	Exhaust O-Ring 2 Req	\$3.92	670E3039			
					PV043018AFM	Front Power Valve	\$3.80	11060-1690			
					PV044060AFM	Right Power Valve	\$3.80	11060-1686			
					PV067018AFM	Power Valve Rod Gasket	\$3.80	11060-1346			
			<b>Clutch &amp; Mag Kit</b>	<b>List Price</b>	<b>Component Part#</b>	<b>Component Description</b>	<b>List Price</b>	<b>OEM Part #</b>			
			C7117CM	\$16.13	EC198018AFM	Outer Clutch Cover Gasket	\$8.69	11060-1351			
					EC199018AFM	Mag Cover Gasket	\$7.44	11060-1189			
			<b>Crank Seal Kit</b>	<b>List Price</b>	<b>Component Part#</b>	<b>Component Description</b>	<b>List Price</b>	<b>OEM Part #</b>			
			C7657	\$16.99	OS112	Right Side Oil Seal	\$10.68	92049-1301			
			OS111	Left Side Oil Seal	\$8.29	92049-1300					
KX125	98-00	56 mm	C7393	\$35.72	H0251010S	Head Gasket 56mm	\$17.38	11004-1252			
					H0410010S	Head Gasket 58mm	\$17.38				
		58 mm	C7414	\$35.72	B0423018AFM	Base Gasket - 2000	\$5.34	11060-1955			
					B0181018AFM	Base Gasket	\$5.34	11060-1769			
					B0423012F	High Comp. Base Gasket - 2000	\$5.34				
					B0181012F	Big Bore High Comp. Base	\$5.34				
					IR007018AFM	Intake Gasket	\$3.80	11009-1941			
					EX292080C	Exhaust Gasket	\$8.63	11060-1370			
					EX123020C	Exhaust Manifold Gasket	\$8.57	11060-1790 (1)			
					PV108032AFM	Front Power Valve Gasket	\$3.80	11060-1788			
					PV067018AFM	Power Valve Rod Gasket	\$3.80	11060-1346			
					PV065018AFM	Right Power Valve Cover	\$3.80	11060-1789			
					WP030018AFM	Water Inlet Gasket	\$1.93	11009-1935			
					R223V	Exhaust O-Ring 2 Req	\$3.92	670E3039			
	<b>Clutch &amp; Mag Kit</b>	<b>List Price</b>	<b>Component Part#</b>	<b>Component Description</b>	<b>List Price</b>	<b>OEM Part #</b>					
	C7117CM	\$16.13	EC198018AFM	Outer Clutch Cover Gasket	\$8.69	11060-1351					
			EC199018AFM	Mag Cover Gasket	\$7.44	11060-1189					
	<b>Crank Seal Kit</b>	<b>List Price</b>	<b>Component Part#</b>	<b>Component Description</b>	<b>List Price</b>	<b>OEM Part #</b>					
	C7657	\$16.99	OS112	Right Side Oil Seal	\$10.68	92049-1301					
			OS111	Left Side Oil Seal	\$8.29	92049-1300					

See Pg.69 for Bottom End and Oil Seal Kit

See Pg.69 for Bottom End and Oil Seal Kit

See Pg.69 for Bottom End and Oil Seal Kit

All Component Parts can be purchased individually.



**WARNING:** Cancer and Reproductive Harm [www.P65Warnings.ca.gov](http://www.P65Warnings.ca.gov)



# MX/Dirt • Off-Road Gaskets



Cometic Gasket - An Exclusive NASCAR Performance® Product

## KAWASAKI KX125

Model	Year	Bore Size	Top End Kit	List Price	Component Part#	Component Description	List Price	OEM Part #									
KX125	01-02	56 mm	C7762	\$38.33	H0251010S	Head Gasket 56mm	\$17.38	11004-1252									
			C7763	\$38.33	H0410010S	Head Gasket 58mm	\$17.38										
		58 mm			B0502018AFM	Base Gasket	\$9.03	11060-1998									
					B0502012F	High Compression Base Gasket	\$9.03										
				EX292080C	Exhaust Gasket	\$8.63	11060-1370										
				EX123020C	Exhaust Manifold Gasket	\$8.57	11060-1790										
				IR007018AFM	Intake Gasket	\$3.80	11009-1941										
				PV065018AFM	Right Power Valve Cover	\$3.80	11060-1789										
				PV067018AFM	Power Valve Rod Gasket	\$3.80	11060-1346										
				PV108032AFM	Front Power Valve Gasket	\$3.80	11060-1876										
				WP030018AFM	Water Inlet Pipe	\$1.93	11009-1935										
				R223V	Exhaust O-Ring 2 Req	\$3.92	670E3042										
				<b>Clutch &amp; Mag Kit</b>	<b>List Price</b>	<b>Component Part#</b>	<b>Component Description</b>	<b>List Price</b>	<b>OEM Part #</b>								
				C7117CM	\$16.13	EC198018AFM	Outer Clutch Cover Gasket	\$8.69	11060-1351								
						EC199018AFM	Mag Cover Gasket	\$7.44	11060-1189								
		<b>Crank Seal Kit</b>	<b>List Price</b>	<b>Component Part#</b>	<b>Component Description</b>	<b>List Price</b>	<b>OEM Part #</b>										
		C7657	\$16.99	OS112	Right Oil Seal	\$10.68	92049-1301										
				OS111	Left Oil Seal	\$8.29	92049-1300										
KX125	94-02			<b>Bottom End Kit w/Oil Seals</b>	<b>List Price</b>	<b>Component Part#</b>	<b>Component Description</b>	<b>List Price</b>	<b>OEM Part #</b>								
										C7762BE	\$77.80	R018B	Case Galley O-ring	\$3.92	92055-086		
												WA107	Drain Plug Crush Washer	\$2.74	92065-058		
												IR007018AFM	Reed Valve Gasket	\$3.80	11009-1941		
												IR007SP1018AFM	Reed Valve Guide Gasket		11060-1997		
												R018B	Primary Gear O-ring	\$3.92	92055-086		
												EC199018AFM	Mag Cover Gasket	\$7.44	11060-1189		
												WP030018AFM	Water Pump Elbow Gasket	\$1.93	11009-1935		
												WP037018AFM	Water Pump Cover Gasket	\$3.74	11009-1936		
												WA118	Water Pump Drain Plug Crush Washer	\$1.88	92022-304		
												R018B	Primary Gear O-ring	\$3.92	92055-086		
												EC197018AFM	Inner Clutch Cover Gasket	\$16.13	11060-1350		
												EC198018AFM	Clutch Cover Gasket	\$8.69	11060-1351		
												<b>Oil Seal Kit</b>	<b>List Price</b>	<b>Component Part#</b>	<b>Component Description</b>	<b>List Price</b>	<b>OEM Part #</b>
												C7762OS	\$38.99	OS111	Left Crank Seal	\$8.29	92049-1300
														OS112	Right Crank Seal	\$10.68	92049-1301
														OS308	Start Shaft Seal 16x24x4	\$5.89	92049-002
														OS331	Shift Shaft Seal	\$3.71	92051-005
														OS360	Outer Water Pump Seal 8x18x3.5	\$5.31	92049-1359
														OS361	Inner Water Pump Seal 8x18x10	\$9.43	92049-1366
														OS362	Power Valve Governor Seal 8x14x4	\$4.51	92049-1207
														OS365	Clutch Pushrod Seal	\$2.50	92049-1414
														OS435	Output Shaft Seal 27x37x7	\$5.21	92049-1413

All Component Parts can be purchased individually.

**WARNING:** Cancer and Reproductive Harm [www.P65Warnings.ca.gov](http://www.P65Warnings.ca.gov)



# MX/Dirt • Off-Road Gaskets



Cometic Gasket - An Exclusive NASCAR Performance® Product

## KAWASAKI KX125

Model	Year	Bore Size	Top End Kit	List Price	Component Part#	Component Description	List Price	OEM Part #		
KX125	03	O-Ring	C7921	\$38.33	R93X2B	Outer O-Ring Head Gasket	\$2.79	92055-1679		
					R62X2V	Inner O-Ring Head Gasket	\$4.64	92055-1679		
					B0604018AFM	Base Gasket	\$8.69	11061-1130		
					B0604012F	High Compression Base Gasket	\$8.69	11061-1130		
					R45X3V	Exhaust O-Ring 2 Req	\$2.71	670E3045		
					PV120018AFM	Right Power Valve Gasket	\$4.72	11061-1132		
					PV119018AFM	Front Power Valve Gasket	\$4.72	11061-1131		
					WA123	Head Bolt Washers 6 Req	\$1.96	11061-1133		
					<b>Clutch &amp; Mag Kit</b>	<b>List Price</b>	<b>Component Part#</b>	<b>Component Description</b>	<b>List Price</b>	<b>OEM Part #</b>
					C7921CM	\$20.67	EC756018AFM	Outer Clutch Cover Gasket	\$8.69	11061-1135
							EC199018AFM	Mag Cover Gasket	\$7.44	11060-1189
					<b>Crank Seal Kit</b>	<b>List Price</b>	<b>Component Part#</b>	<b>Component Description</b>	<b>List Price</b>	<b>OEM Part #</b>
C7657	\$16.99	OS112	Right Oil Seal	\$10.68	92049-1301					
		OS111	Left Oil Seal	\$8.29	92049-1300					
KX125	04-07	O-Ring	C7203	\$38.33	<b>Component Part#</b>	<b>Component Description</b>	<b>List Price</b>	<b>OEM Part #</b>		
					R93X2B	Outer Head O-Ring	\$2.79	92055-1679		
					R62X2V	Inner Head O-Ring	\$4.64	92053-1678		
					B0692018AFM	Base Gasket	\$9.32	11061-0039		
					B0692012F	High Compression Base Gasket	\$9.32	11061-0039		
					PV120018AFM	Right Power Valve Gasket	\$4.72	11061-1132		
					PV119018AFM	Front Power Valve Gasket	\$4.72	11061-1131		
					R45X3V	Exhaust O-Ring 2 req	\$2.71	670E3045		
					WA123	Head Bolt Washers 6 Req	\$1.96	11061-1133		
					<b>Clutch &amp; Mag Kit</b>	<b>List Price</b>	<b>Component Part#</b>	<b>Component Description</b>	<b>List Price</b>	<b>OEM Part #</b>
					C7921CM	\$20.67	EC756018AFM	Outer Clutch Cover Gasket	\$8.69	11061-1135
					<b>Crank Seal Kit</b>	<b>List Price</b>	<b>Component Part#</b>	<b>Component Description</b>	<b>List Price</b>	<b>OEM Part #</b>
C7657	\$16.99	OS112	Right Oil Seal	\$10.68	92049-1301					
		OS111	Left Oil Seal	\$8.29	92049-1300					
KX125	03-07		C7921BE	\$77.80	<b>Bottom End Kit w/Oil Seals</b>	<b>Component Part#</b>	<b>Component Description</b>	<b>List Price</b>	<b>OEM Part #</b>	
					R018B	Case Galley O-ring	\$3.92	92055-086		
					WA108	Drain Plug Crush Washer 10.5x16x1	\$2.56	92065-058		
					R018B	Primary Gear O-ring	\$3.92	92055-086		
					EC760032AFM	Mag Cover Gasket	\$11.98	11061-0038		
					R5.5X1.5B	Power Valve Governor O-ring 5.5x1.5	\$2.19	92055-1343		
					WP151018AFM	Water Pump Cover	\$4.72	11061-1150		
					EC756032AFM	Clutch Cover Gasket	\$8.69	11061-1135		
					EC767018AFM	Primary Cover Gasket	\$19.82	11061-1134		
					WA118	Water Pump Drain Plug Crush Washer	\$1.88	92022-304		
					R018V	Output Shaft Backup Ring	\$3.92	92055-055		
					<b>Oil Seal Kit</b>	<b>List Price</b>	<b>Component Part#</b>	<b>Component Description</b>	<b>List Price</b>	<b>OEM Part #</b>
C7762OS	\$38.99	OS111	Left Crank Seal	\$8.29	92049-1300					
		OS123	Right Crank Seal	\$10.68	92049-1301					
		OS308	Start Shaft Seal 16x24x4	\$5.89	92049-002					
		OS331	Shift Shaft Seal	\$3.71	92051-005					
		OS360	Outer Water Pump Seal 8x18x3.5	\$5.31	92049-1359					
		OS361	Inner Water Pump Seal 8x18x10	\$9.43	92049-1366					
		OS362	Power Valve Governor Seal 8x14x4	\$4.51	92049-1207					
		OS365	Clutch Pushrod Seal	\$2.50	92049-1414					
		OS435	Output Shaft Seal 27x37x7	\$5.21	92049-1413					



# MX/Dirt · Off-Road Gaskets



Cometic Gasket - An Exclusive NASCAR Performance® Product

## KAWASAKI KDX200

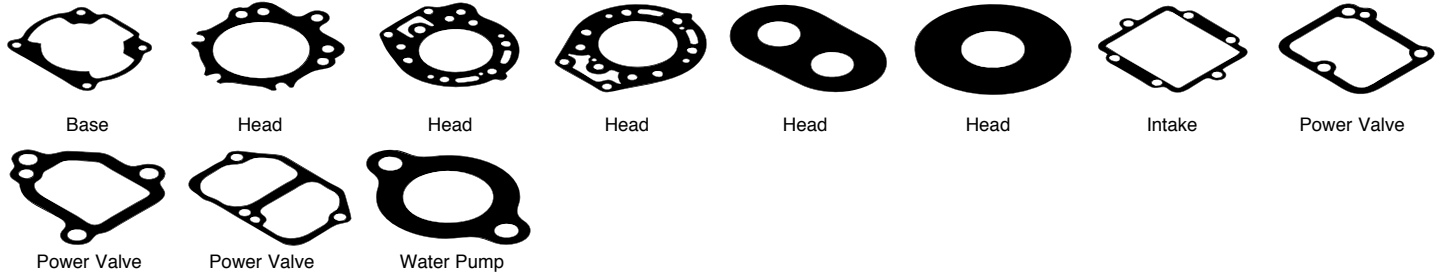

Model	Year	Bore Size	Top End Kit	List Price	Component Part#	Component Description	List Price	OEM Part #		
KDX200	86-88	68 mm	C7042	\$29.47	H0019043F	Head Gasket 68mm	\$19.82	11009-1141		
					B0023020F	Base Gasket	\$5.34	11009-1541		
					IR007018AFM	Intake Gasket	\$3.80	11009-1263		
					PV008020F	Power Valve Gasket	\$3.80	11009-1542		
KDX200	89-94	68 mm	C7043	\$42.13	H0299010S	Head Gasket 68mm	\$30.95	11004-1189		
			C7321	\$42.13	H0201043F	Head Gasket 74mm	\$21.76			
						H0458020C	Head Insert	\$1.36		
						H0457020C	Head Insert	\$1.30		
						B0023020F	Base Gasket	\$5.34	11004-1659	
						IR007018AFM	Intake Gasket	\$3.80	11009-1941	
						PV010020F	Right Power Valve Gasket	\$3.80	11009-1934	
						PV009018AFM	Left Power Valve Gasket	\$3.80	11009-1968	
						WP029018AFM	Water Spigot Gasket	\$5.00	11009-1993	
		KDX200	95-06	68 mm	C7242	\$42.13	H0343010S	Head Gasket 68mm	\$30.95	11004-1298
					C7320	\$42.13	H0399043F	Head Gasket 73mm	\$21.76	
						B0203018AFM	Base Gasket	\$5.34	11060-1659	
						IR007018AFM	Intake Gasket	\$3.80	11009-1941	
						PV060018AFM	Left Power Valve Gasket	\$3.80	11060-1628	
						PV047018AFM	Right Power Valve Gasket	\$3.80	11060-1629	
						PV046018AFM	Resonator Cover Gasket	\$3.80	11060-1627	
						WP029018AFM	Water Spigot Gasket	\$5.00	11009-1993	
						R222V	Exhaust Gasket 2 Req	\$3.92	670E3039	
KDX220R	97-05			70 mm	C7298	\$42.13	H0439010S	Head Gasket 70mm	\$30.95	
		B0203018AFM	Base Gasket				\$5.34	11060-1659		
		IR007018AFM	Intake Gasket				\$3.80	11009-1941		
		PV060018AFM	Left Power Valve Gasket				\$3.80	11060-1628		
		PV047018AFM	Right Power Valve Gasket				\$3.80	11060-1629		
		PV046018AFM	Resonator Cover Gasket				\$3.80	11060-1627		

## KAWASAKI KDX250

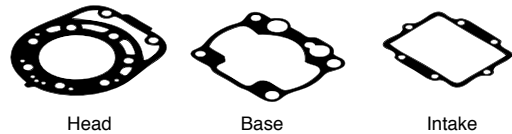

Model	Year	Bore Size	Top End Kit	List Price	Component Part#	Component Description	List Price	OEM Part #
KDX250	91-94	69 mm	C7134	\$34.27	H0293010S	Head Gasket 69mm	\$22.83	11004-1240
					B0113018AFM	Base Gasket	\$5.34	11060-1493
					IR008018AFM	Intake Gasket	\$3.80	11009-1950
					PV013018AFM	Front Power Valve Gasket	\$3.80	11060-1289
					PV012020F	Right Power Valve Gasket	\$3.80	11060-1290
KL, KLR250	85-05	77 mm	C7244	\$34.60	H0341010C	Head Gasket 77mm	\$28.51	11004-1121
					B0198020F	Base Gasket	\$9.94	11060-1125
KLX250R	94-14	73 mm	C7214	\$30.14	H0230043F	Head Gasket 73mm	\$24.75	11004-1249
					B0155020RC	Base Gasket	\$8.75	11060-1319

All Component Parts can be purchased individually.

**WARNING:** Cancer and Reproductive Harm [www.P65Warnings.ca.gov](http://www.P65Warnings.ca.gov)





Cometic Gasket - An Exclusive NASCAR Performance® Product

## KAWASAKI KX250

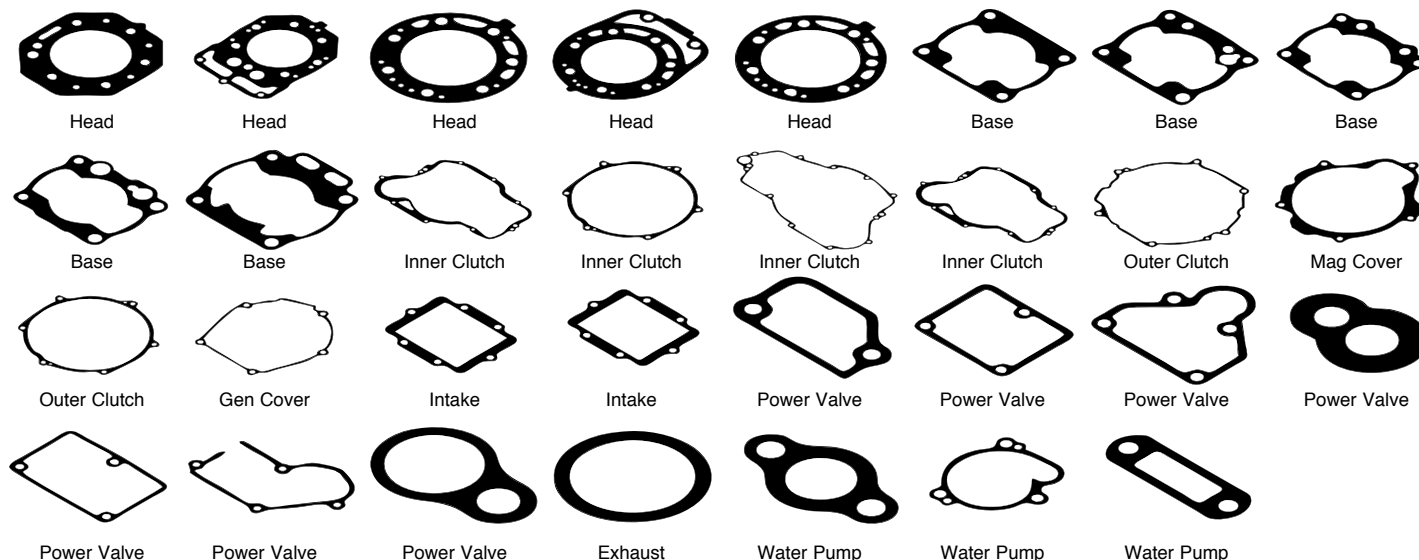

Model	Year	Bore Size	Top End Kit	List Price	Component Part#	Component Description	List Price	OEM Part #	
KX250	83-84	72 mm	Top End Kit	C7111	\$23.46	H0022043F	Head Gasket 72mm	\$19.82	11004-1057
						B0025020F	Base Gasket	\$6.25	11009-1318
			Crank Seal Kit	C7658	\$27.80	OS110	20X40X7 Left Oil Seal	\$9.47	92049-1052
						OS187	Right Oil Seal	\$16.64	92049-1051
KX250 D1	85	72 mm	Top End Kit	C7037	\$33.45	H0023043F	Head Gasket 72mm	\$21.76	11004-1126
						B0025020F	Base Gasket	\$6.25	11004-1462
						IR008018AFM	Intake Gasket	\$3.80	11009-1950
						R136V	Exhaust Gasket 2 Req	\$1.19	671E2550
			Crank Seal Kit	C7658	\$27.80	OS110	20X40X7 Left Oil Seal	\$9.47	92049-1052
						OS187	Right Oil Seal	\$16.64	92049-1051
KX250 D2	86	72 mm	Top End Kit	C7038	\$28.99	H0023043F	Head Gasket 72mm	\$21.76	11004-1126
						B0026020F	Base Gasket	\$6.25	11009-1546
						IR008018AFM	Intake Gasket	\$3.80	11009-1950
						R136V	Exhaust Gasket 2 Req	\$1.19	671E2550
			Crank Seal Kit	C7658	\$27.80	OS110	20X40X7 Left Oil Seal	\$9.47	92049-1052
						OS187	Right Oil Seal	\$16.64	92049-1051
KX250 E1	87	69.5 mm	Top End Kit	C7039	\$32.43	H0034043F	Head Gasket 69.5mm	\$19.82	11004-1157
						B0032020F	Base Gasket	\$6.25	11009-1624
						IR008018AFM	Intake Gasket	\$3.80	11004-1950
						PV012020F	Right Power Valve Gasket	\$3.80	11009-1946
						R136V	Exhaust Gasket 2 Req	\$1.19	671E2550
			Crank Seal Kit	C7658	\$27.80	OS110	20X40X7 Left Oil Seal	\$9.47	92049-1051
						OS187	Right Oil Seal	\$16.64	92049-1052
KX250 F1, G1, H1	88-90	69 mm	Top End Kit	C7040	\$44.69	H0293010S	Head Gasket 69mm	\$22.83	11004-1121
						B0033020F	Base Gasket	\$6.25	11009-1700
						IR008018AFM	Intake Gasket	\$3.80	11009-1252
						PV013018AFM	Front Power Valve Gasket	\$3.80	11009-1701
						PV012020F	Right Power Valve Gasket	\$3.80	11009-1625
						R136V	Exhaust Gasket 2 Req	\$1.19	671E2550
						WP030018AFM	Water Inlet Gasket	\$1.93	11009-1696
			Crank Seal Kit	C7658	\$27.80	OS110	20X40X7 Left Oil Seal	\$9.47	92049-1052
						OS187	Right Oil Seal	\$16.64	92049-1051



# MX/Dirt · Off-Road Gaskets



Cometic Gasket - An Exclusive NASCAR Performance® Product

## KAWASAKI KX250 H2

Model	Year	Bore Size	Top End Kit	List Price	Component Part#	Component Description	List Price	OEM Part #					
KX250 H2	91	69mm	C7041	\$37.59	H0293010S	69mm Head Gasket	\$22.83	11004-1217					
					B0034020F	Base Gasket	\$6.25	11009-1947					
					IR008018AFM	Intake Gasket	\$3.80	11009-1251					
					PV013018AFM	Front Power Valve Gasket	\$3.80	11009-1701					
					PV012020F	Right Power Valve Gasket	\$3.80	11009-1625					
					R136V	Exhaust Gasket 2-Req	\$1.19	671E2550					
					WP030018AFM	Water Inlet Gasket	\$1.93	11009-1696					
					<b>Crank Seal Kit</b>	<b>List Price</b>	<b>Component Part#</b>	<b>Component Description</b>	<b>List Price</b>	<b>OEM Part #</b>			
					C7658	\$27.80	OS110	20X40X7 Left Oil Seal	\$9.47	92049-1051			
							OS187	Right Oil Seal	\$16.64	92049-1052			
KX250	92	69 mm	C7100	\$37.59	H0293010S	Head Gasket 69mm	\$22.83	11004-1229					
					B0034020F	Base Gasket	\$6.25	11009-1947					
					IR008018AFM	Intake Gasket	\$3.80	11009-1252					
					PV012020F	Right Power Valve Gasket	\$3.80	11009-1625					
					PV013018AFM	Front Power Valve Gasket	\$3.80	11009-1701					
					WP030018AFM	Water Inlet Gasket	\$1.93	11009-1696					
					R136V	Exhaust Gasket 2 Req	\$1.19	671E2550					
					<b>Clutch &amp; Mag Kit</b>	<b>List Price</b>	<b>Component Part#</b>	<b>Component Description</b>	<b>List Price</b>	<b>OEM Part #</b>			
					C7135CM	\$24.78	C7478	Outer Clutch Cover Gasket	\$12.39	11060-1186			
							EC203018AFM	Mag Cover Gasket	\$12.39	11009-1951			
					<b>Crank Seal Kit</b>	<b>List Price</b>	<b>Component Part#</b>	<b>Component Description</b>	<b>List Price</b>	<b>OEM Part #</b>			
					C7658	\$27.80	OS113	Right Oil Seal	\$16.64	92049-1051			
							OS187	20X40X7 Left Oil Seal	\$9.47	92049-1052			
					KX250	88-93	68.5 mm	C7135	\$44.69	H0253010S	Head Gasket 68.5mm	\$19.82	11004-1174
										B0113018AFM	Base Gasket	\$9.32	11009-1700
IR008018AFM	Intake Gasket	\$3.80	11009-1252										
PV014018AFM	Right Power Valve Gasket	\$3.80	11009-1625										
PV039018AFM	Front Power Valve Gasket	\$3.80	11060-1289										
PV040018AFM	Resonator Cover Gasket	\$3.80	11060-1290										
R136V	Exhaust Gasket 2 Req	\$1.19	671E2550										
WP030018AFM	Water Inlet Gasket	\$1.93	11009-1696										
PV067018AFM	Power Valve Rod Gasket	\$3.80	11060-1346										
<b>Clutch &amp; Mag Kit</b>	<b>List Price</b>	<b>Component Part#</b>	<b>Component Description</b>	<b>List Price</b>						<b>OEM Part #</b>			
C7135CM	\$24.78	C7478	Outer Clutch Cover Gasket	\$12.39						11060-1186			
		EC203018AFM	Mag Cover Gasket	\$12.39						11009-1951			
<b>Crank Seal Kit</b>	<b>List Price</b>	<b>Component Part#</b>	<b>Component Description</b>	<b>List Price</b>						<b>OEM Part #</b>			
C7658	\$27.80	OS113	Right Oil Seal	\$16.64						92049-1051			
		OS187	20X40X7 Left Oil Seal	\$9.47						92049-1052			
KX250	93	68.5 mm	C7135	\$44.69	H0253010S	Head Gasket 68.5mm	\$19.82	11004-1240					
					B0113018AFM	Base Gasket	\$9.32	11060-1147					
					IR008018AFM	Intake Gasket	\$3.80	11009-1252					
					PV067018AFM	Power Valve Rod Gasket	\$3.80	11060-1290					
					PV014018AFM	Right Power Valve Gasket	\$3.80	14090-1226					
					PV039018AFM	Front Power Valve Gasket	\$3.80	11060-1147					
					PV040018AFM	Resonator Cover Gasket	\$3.80	11060-1289					
					R136V	Exhaust Gasket 2 Req	\$1.19	671E2550					
					<b>Bottom End Kit w/crank seals</b>	<b>List Price</b>	<b>Component Part#</b>	<b>Component Description</b>	<b>List Price</b>	<b>OEM Part #</b>			
					C3351	\$56.99	EC200018AFM	Inner Clutch Cover Gasket	\$9.94	11060-1185			
							EC203018AFM	Mag Cover Gasket	\$12.39	11009-1951			
							C7478	Outer Clutch Cover Gasket	\$12.39	11060-1186			
							WP055018AFM	Water Pump Gasket	\$3.74	11060-1184			
							WP030018AFM	Water Inlet Gasket	\$1.93	11009-1935			
					<b>Clutch &amp; Mag Kit</b>	<b>List Price</b>	<b>Component Part#</b>	<b>Component Description</b>	<b>List Price</b>	<b>OEM Part #</b>			
C7135CM	\$24.78	C7478	Outer Clutch Cover Gasket	\$12.39	11060-1186								
		EC203018AFM	Mag Cover Gasket	\$12.39	11009-1951								
<b>Crank Seal Kit</b>	<b>List Price</b>	<b>Component Part#</b>	<b>Component Part#</b>	<b>List Price</b>	<b>OEM Part#</b>								
C7658	\$27.80	OS113	Right Oil Seal	\$16.64	92049-1051								
		OS187	20X40X7 Left Oil Seal	\$9.47	92049-1052								

All Component Parts can be purchased individually.

**WARNING:** Cancer and Reproductive Harm www.P65Warnings.ca.gov



# MX/Dirt • Off-Road Gaskets



Cometic Gasket - An Exclusive NASCAR Performance® Product

## KAWASAKI KX250

Model	Year	Bore Size	Top End Kit	List Price	Component Part#	Component Description	List Price	OEM Part #
KX250	94-00	68.5 mm	C7155	\$44.69	B0113012F	High Compression Base Gasket	\$9.32	11060-1493
		74 mm	C7304	\$44.69	B0113018AFM	Base Gasket	\$9.32	11060-1493
					H0253010S	Head Gasket 68.5mm	\$19.82	11004-1240
					H0417010S	Head Gasket 74mm	\$19.82	
					I R008018AFM	Intake Gasket	\$3.80	11009-1950
					PV014018AFM	Right Power Valve Gasket	\$3.80	11009-1960
					PV039018AFM	Front Power Valve Gasket	\$3.80	11060-1147
					PV040018AFM	Resonator Cover Gasket	\$3.80	11060-1226
					V067018AFM	Power Valve Rod Gasket	\$3.80	11060-1290
					R136V	Exhaust Gasket 2 Req	\$1.19	92055-1666
					WP030018AFM	Water Inlet Gasket	\$1.93	11009-1935
			<b>Bottom End Kit w/crank seals</b>	<b>List Price</b>	<b>Component Part#</b>	<b>Component Description</b>	<b>List Price</b>	<b>OEM Part #</b>
			C3351	\$56.99	EC200018AFM	Inner Clutch Cover Gasket	\$9.94	11060-1185
					EC203018AFM	Mag Cover Gasket	\$12.39	11009-1951
					C7478	Outer Clutch Cover Gasket	\$12.39	11060-1186
					WP055018AFM	Water Pump Gasket	\$3.74	11060-1184
					WP030018AFM	Water Inlet Gasket	\$1.93	11009-1935
			<b>Clutch &amp; Mag Kit</b>	<b>List Price</b>	<b>Component Part#</b>	<b>Component Description</b>	<b>List Price</b>	<b>OEM Part #</b>
			C7135CM	\$24.78	C7478	Outer Clutch Cover Gasket	\$12.39	11060-1186
					EC203018AFM	Mag Cover Gasket	\$12.39	11009-1951
			<b>Crank Seal Kit</b>	<b>List Price</b>	<b>Component Part#</b>	<b>Component Description</b>	<b>List Price</b>	<b>OEM Part #</b>
			C7658	\$27.80	OS113	Right Oil Seal	\$16.64	92049-1051
					OS187	20X40X7 Left Oil Seal	\$9.47	92049-1052
KX250	01	68.5 mm	<b>Top End Kit</b>	<b>List Price</b>	<b>Component Part#</b>	<b>Component Description</b>	<b>List Price</b>	<b>OEM Part #</b>
		74 mm	C7764	\$44.69	H0253010S	Head Gasket 68.5mm	\$19.82	11004-0014
			C7765	\$44.69	H0417010S	Head Gasket 74mm	\$19.82	11004-0013
					B0113018AFM	Base Gasket	\$9.32	11060-1493
					B0113012F	High Compression Base Gasket	\$9.32	11060-1493
					IR173018AFM	Intake Gasket	\$3.80	11060-1993
					PV014018AFM	Right Power Valve Gasket	\$3.80	11009-1960
					PV039018AFM	Front Power Valve Gasket	\$3.80	11060-1289
					PV040018AFM	Resonator Cover Gasket	\$3.80	11060-1290
					PV067018AFM	Power Valve Rod Gasket	\$3.80	11060-1346
					EX290080C	Exhaust Gasket	\$9.99	11060-1689
					WP030018AFM	Water Inlet Gasket	\$1.93	11009-1935
					R136V	Exhaust Gasket 2 Req	\$1.19	92055-1666
		KX250	02-03	68.5 mm	<b>Top End Kit</b>	<b>List Price</b>	<b>Component Part#</b>	<b>Component Description</b>
	C7861			\$48.50	H0253010S	Head Gasket 68.5mm	\$19.82	11004-1240
					B0113012F	High Compression Base Gasket	\$9.32	11060-1493
					R49.5X3V	Exhaust O-Ring 2 Req	\$4.29	92055-1666
					B0113018AFM	Base Gasket	\$9.32	11060-1493
					IR173018AFM	Intake Gasket	\$3.80	11060-1993
					EX290080C	Exhaust Gasket	\$9.99	11060-1689
					PV014018AFM	Right Power Valve Gasket	\$3.80	11009-1960
					PV039018AFM	Front Power Valve Gasket	\$3.80	11060-1289
					PV040018AFM	Resonator Cover Gasket	\$3.80	11060-1290
					PV067018AFM	Power Valve Rod Gasket	\$3.80	11060-1346
KX250	04			68.5 mm	<b>Top End Kit</b>	<b>List Price</b>	<b>Component Part#</b>	<b>Component Description</b>
		70.5 mm	C7269	\$53.37	H2155010S	Head Gasket 68.5mm	\$19.82	11004-0013
			C7284	\$53.37	H2156010S	Head Gasket 70.5mm	\$19.82	
					B0743018AFM	Base Gasket	\$9.32	11061-0040
					B0743012F	High Compression Base Gasket	\$9.32	11061-0040
					IR173018AFM	Intake Gasket	\$3.80	11060-1993
					EX290080C	Exhaust Gasket	\$9.99	11060-1689
					PV014018AFM	Right Power Valve Gasket	\$3.80	11009-1960
					PV039018AFM	Front Power Valve Gasket	\$3.80	11060-1289
					PV040018AFM	Resonator Cover Gasket	\$3.80	11060-1290
					PV067018AFM	Power Valve Rod Gasket	\$3.80	11060-1346
					R017B	Power Valve O-Ring 2 Req	\$1.14	
					R49.5X3V	Exhaust O-Ring 2 Req	\$4.29	92055-1666



# MX/Dirt · Off-Road Gaskets



Cometic Gasket - An Exclusive NASCAR Performance® Product

## KAWASAKI KX250

Model	Year		Bottom End Kit	List Price	Component Part#	Component Description	List Price	OEM Part #				
KX250	92-04		w/oil seals C7861BE	\$76.99	EC200018AFM	Primary Gasket 1992-1996	\$9.94	11060-1185				
					EC202018AFM	Primary Gasket 1997-2004	\$17.38	11061-1058				
					R020V	Output Shaft O-Ring	\$1.19	92055-035				
					R5.5X1.5B	Governor O-ring	\$2.19	92055-1343				
					WA107	Drain Plug Gasket	\$2.74	92065-058				
					WA118	Water Pump Drain Crush Washer	\$1.88	92022-304				
					WP055018AFM	Water Pump Gasket	\$3.74	11060-1184				
					WP117018AFM	Water Pump Outlet Gasket	\$2.56	11060-1183				
					<b>Oil Seal Kit</b>			<b>List Price</b>	<b>Component Part#</b>	<b>Component Description</b>	<b>List Price</b>	<b>OEM Part #</b>
					C7861OS	\$48.58	OS110	Left Crank Seal	\$9.47	92049-1052		
							OS187	Right Crank Seal	\$16.64	92049-1051		
							OS285	Start Shaft Seal	\$1.48	92049-1594		
							OS295	Output Shaft Seal	\$9.89	92050-033/ 92049-1556		
							OS306	Clutch Actuator Seal	\$2.91	92049-1262		
							OS307	Start Shaft Seal	\$7.03	92049-013		
		OS331	Shift Shaft Seal	\$3.71	92051-005							
		OS360	Water Pump Seal	\$5.31	92049-0033							
		OS361	Water Pump Seal	\$9.43	92049-1366 92049-0034							
		OS362	Governor Shaft Seal	\$4.51	92049-1207							
<b>Clutch &amp; Mag Kit</b>			<b>List Price</b>	<b>Component Part#</b>	<b>Component Description</b>	<b>List Price</b>	<b>OEM Part #</b>					
C7135CM	\$24.78	C7478	Outer Clutch Cover Gasket	\$12.39	11060-1186							
		EC203018AFM	Mag Cover Gasket	\$12.39	11009-1951							
KX250	05-07	66.6 mm	Top End Kit C3096	\$24.91	R103X2V	Outer Head O-Ring	\$5.29	92055-0050				
					R74X2S	Inner Head O-Ring	\$3.57	92055-0049				
					B0818018AFM	Base Gasket	\$9.70	11061-0091				
					B0818014RC	High Compression Base Gasket	\$9.70	11061-0091				
					R53.5X2V	Exhaust O-Ring 2 Req	3.07 ea.	92055-0052				
					EX290080C	Exhaust Gasket	\$9.99	11061-0142				
					PV128018AFM	Front Power Valve Gasket	\$4.72	11061-0092				
					PV129018AFM	Left Power Valve Gasket	\$4.72	11061-0093				
					PV130018AFM	Power Valve Gasket 2 Req	\$1.13	11061-0138				
					WA123	Head Bolt Washers 6 Req	\$1.96	11061-1133				
					R8.5X2V	R8.5X2V	\$1.10					
					<b>Bottom End Kit</b>			<b>List Price</b>	<b>Component Part#</b>	<b>Component Description</b>	<b>List Price</b>	<b>OEM Part #</b>
					C3096BE	\$74.83	MR202	Case Coolant Galley Gasket	5.6	92055-0059		
							WA107	Case Drain Plug	\$2.74	92065-058		
							R5.5X1.5B	Centrifugal Power Valve O-ring	\$2.19	92055-1343		
		R116B	Water Pump Elbow O-ring	\$1.13	92055-1308							
		WP151018AFM	Water Pump Gasket	4.72	11061-0097							
		WA118	Water Pump Drain Crush Washer	1.88	92022-304							
		R117B	Fill Plug O-ring	\$0.42	92055-1146							
		EC1031018AFM	Primary Cover Gasket	20.22	11061-0095							
<b>Oil Seal Kit</b>			<b>List Price</b>	<b>Component Part#</b>	<b>Component Description</b>	<b>List Price</b>	<b>OEM Part #</b>					
C3096OS	\$50.68	OS187	Right Crank Seal	16.64	92049-0031							
		OS285	Start Shaft Seal	\$1.48	92049-1594							
		OS295	Output Shaft Seal	\$9.89	92049-0030							
		OS306	Clutch Actuator Shaft Seal	\$2.91	92049-1262							
		OS331	Shift Shaft Seal	3.71	92051-005							
		OS360	Impeller Seal	\$5.31	92049-0033							
		OS361	Water Pump Shaft Seal	\$9.43	92049-0034							
		OS362	Power Valve Governor Seal	4.51	92049-1207							
<b>Clutch &amp; Mag Kit</b>			<b>List Price</b>	<b>Component Part#</b>	<b>Component Description</b>	<b>List Price</b>	<b>OEM Part #</b>					
C3096CM	\$23.78	EC1032032AFM	Clutch Cover Gasket	\$14.31	11061-0144							
		EC1033032AFM	Mag Cover Gasket	9.47	11061-0098							

All Component Parts can be purchased individually.



**WARNING:** Cancer and Reproductive Harm www.P65Warnings.ca.gov





# MX/Dirt • Off-Road Gaskets



Cometic Gasket - An Exclusive NASCAR Performance® Product

## KAWASAKI KX250F



Head



Head



Head



Base



Exhaust



OuterClutch



Inner Clutch

Model	Year	Bore Size	EST	List Price	Component Part#	Component Description	List Price	OEM Part #
KX250F	04-08	77 mm	C3174-EST	\$74.99	H2169SP1027S	Head Gasket 77mm	\$43.39	11004-0003
		78 mm	C3054-EST	\$74.99	H2096027S	Head Gasket 78mm	\$43.39	
		80 mm	C3056-EST	\$74.99	H2169027S	Head Gasket 80mm	\$43.39	
		81mm	C7221-EST	\$74.99	H1967027S	Head Gasket 81mm	\$43.39	
		83 mm	C3135-EST	\$74.99	H2471SP1027S	Head Gasket 83mm	\$43.39	
		84 mm	C3118-EST	\$74.99	H2471027S	Head Gasket 84mm	\$43.39	
						B0691014RC	Base Gasket	
				EX651	Exhaust Gasket	\$8.98	11061-0027	
				R018B	Camchain Tensioner O-Ring	\$3.92	92055-086	
				3233V	Valve Stem Seal 4 Req	\$5.11 ea.	92049-1349	

Bottom End Kit w/Oil Seals	List Price	Component Part#	Component Description	List Price	OEM Part #
C3174BE	\$98.69	WA108	Crank Case Drain Plug Washer	\$2.56	92065-058
		R118B	Crank End Cap O-Ring	\$1.13	670B2022
		EC903032AFM	Inner Clutch Cover Gasket	\$20.99	11061-0030
		R112B	Timing Mark Plug O-Ring	\$3.92	92055-1141
		R117B	Crank Case Oil Fill O-Ring	\$0.42	92055-1146
		R018B	Output Shaft O-Ring (2)	\$3.92	92055-055
		MR042	Water Pump Cover O-Ring	\$3.40	92055-0010
		R116B	Water Pipe O-Ring	\$1.13	92055-1308
Oil Seal Kit	List Price	Component Part#	Component Description	List Price	OEM Part #
C3174OS	\$45.36	OS279	Decompression Shaft Seal 10x18x5	\$1.48	92049-1196
		OS295	Crank Seal 30x40x7	\$9.89	92049-1556
		OS305	Shift Shaft Seal 14x22x6	\$5.77	92049-0015
		OS306	Clutch Actuator Shaft Seal 12x18x4	\$2.91	92049-1262
		OS307	Start Shaft Seal 18x30x7	\$7.03	92049-013
		OS308	Impeller Seal 8x22x7x7.5	\$5.89	92049-0021
		OS309	Inner WP Seal 8x22x5	\$5.89	92049-0016
		OS359	Output Shaft Seal25x40x6	\$3.83	92049-1478
Clutch & Mag Kit	List Price	Component Part#	Component Description	List Price	OEM Part #
C3174CM	\$24.80	EC847060AFM	Outer Clutch Cover Gasket	\$11.18	11061-0031
		EC904032AFM	Mag Cover Gasket	\$13.62	11061-0032
		Component Part#	Component Part#	List Price	OEM Part#
		VC102	Valve Cover Gasket	\$18.51	11061-0024

All Component Parts can be purchased individually.



**WARNING:** Cancer and Reproductive Harm [www.P65Warnings.ca.gov](http://www.P65Warnings.ca.gov)



# MX/Dirt · Off-Road Gaskets



Cometic Gasket - An Exclusive NASCAR Performance® Product

## KAWASAKI KX250F

Model	Year	Bore Size	EST	List Price	Component Part#	Component Description	List Price	OEM Part #
KX250F	09-16	78mm	C3267-EST	\$74.99	H2848027S	Head Gasket 78mm	\$43.39	11004-0079
		79mm	C3274-EST	\$74.99	H2848SP3027S	Head Gasket 79mm	\$43.39	
		80mm	C3271-EST	\$74.99	H2848SP1027S	Head Gasket 80mm	\$43.39	

					B0967020RC	Base Gasket	\$20.99	11061-0357
					EX651	Exhaust Gasket	\$8.98	11061-0027
					R018B	Cam Chain Tensioner O-Ring	\$3.92	92055-086
					3183V	Valve Stem Seals 4 Req	\$5.50	92049-1349
					R021V	Cam Tower O-ring	\$1.19	92055-0046
					R013V	Water Temp Sensor O-Ring	\$1.08	92055-0016
<b>Bottom End Kit</b>	<b>List Price</b>	<b>Component Part#</b>	<b>Component Description</b>	<b>List Price</b>	<b>OEM Part #</b>			
C3267BE	\$98.69	R014V	Timing Mark Plug O-Ring	\$1.08	92055-1011			
		R20X2V	Fill Plug O-ring	\$3.02	92055-1146			
		R27.5X2.5V	Crank End Plug O-ring	\$2.45	92055-091			
		EC1341032AFM	Inner Clutch Cover Gasket	\$13.57	11061-0361			
		WA108	Drain Plug Gasket	\$2.56	92065-058			
		R27.5X2.5V	Neutral Switch Indicator	\$2.45	92055-091			
		R018B	Output Shaft O-rings 2	\$3.92	92055-055			
		MR042	Water Pump Cover O-Ring	\$3.40	92055-0010			
		R116B	Water Pipe O-Ring	\$1.13	92055-1308			
		WA118	Water Pump Crush Seal	\$1.88	92022-304			
<b>Oil Seal Kit</b>	<b>List Price</b>	<b>Component Part#</b>	<b>Component Description</b>	<b>List Price</b>	<b>OEM Part #</b>			
C3267OS	\$50.98	OS295	Output Shaft Seal 30x40x7	\$9.89	92049-0030			
		OS295	Primary Shaft Seal	\$9.89	92049-0030			
		OS305	Shift Shaft Seal 14x22x6	\$5.77	92049-0015			
		OS306	Clutch Actuator Shaft Seal 12x18x4	\$2.91	92049-1262			
		OS307	Kickstart Shaft Seal 18x30x7	7.03	92049-013			
		OS308	Impeller Seal 8x22x7/7.5	\$5.89	92049-0061			
		OS309	Inner WP Seal 8x22x5	\$5.89	92049-0060			
		OS331	Balance Shaft Seal 13x22x5.5	\$3.71	92049-0762			
<b>Clutch &amp; Mag Kit</b>	<b>List Price</b>	<b>Component Part#</b>	<b>Component Description</b>	<b>List Price</b>	<b>OEM Part #</b>			
C3267CM	\$24.80	EC1312032AFM	Outer Clutch Cover Gasket	\$11.18	11061-0362			
		EC1340032AFM	Mag Cover Gasket	\$13.62	11061-0363/11061-0778			

KX250F	17-19	78mm	<b>Top End Kit</b>	<b>List Price</b>	<b>Component Part#</b>	<b>Component Description</b>	<b>List Price</b>	<b>OEM Part #</b>
		80mm	C3619	\$74.99	H4365027S	Head Gasket 78mm	\$43.39	11004-0761
			C3629	\$74.99	H4365SP2027S	Head Gasket 80mm	\$43.39	
					R018B	Cam Chain O-ring	\$3.92	92055-086
					R022V	Cam Tower O-ring	\$1.19	92055-0729
					R031B	Intake Boot O-ring	\$4.65	92055-1401
					B1353014RC	Cylinder Base Gasket	\$20.99	11061-1198
					EX651	Header Gasket	\$8.98	11061-0027
					3183V	Valve Stem Seal	\$5.50	92049-1349
			<b>Bottom End Kit</b>	<b>List Price</b>	<b>Component Part#</b>	<b>Component Description</b>	<b>List Price</b>	<b>OEM Part #</b>
			C3619BE	\$98.69	WA107	Drain Plug Gasket	\$2.74	92065-058
					R117B	Fill Plug O-ring	\$0.42	92055-1146
					EC2201032AFM	Inner Clutch Cover Gasket	\$13.57	11061-1199
					R014V	Timing Mark O-Ring	\$1.08	92055-1011
					R123V	Timing Plug O-Ring	\$1.10	92055-091
					R123V	Gear Position Sensor O-ring	\$1.10	92055-091
					R018B	Output Shaft Back-up O-ring	\$3.92	92055-055
					MR042	Water Pump O-ring	\$3.40	92055-0010
					R031B	Water Pump Cover O-ring	\$4.65	92055-520
					R116B	Water Neck O-ring	\$1.13	92055-1308
					WA133	Water Pump Crush Washers	\$0.90	92200-0190
					WA118	Water Pump Crush Washers	\$1.88	92022-304
			<b>Oil Seal Kit</b>	<b>List Price</b>	<b>Component Part#</b>	<b>Component Description</b>	<b>List Price</b>	<b>OEM Part #</b>
			C3619OS	\$48.92	OS295	Output Shaft Seal	\$9.89	92049-0030
					OS295	Right Crank Seal	\$9.89	92049-0030
					OS306	Clutch Pushrod Oil Seal	\$2.91	92049-1262
					OS307	Start Shaft Seal	\$7.03	92049-013
					OS308	Outer Water Pump Seal	\$5.89	92049-0061
					OS309	Inner Water Pump Oil Seal	\$5.89	92049-0060
					OS331	Shift Shaft Seal	\$3.71	92051-005
					OS331	Oil Pump Seal	\$3.71	92049-0762
			<b>Clutch &amp; Mag Kit</b>	<b>List Price</b>	<b>Component Part#</b>	<b>Component Description</b>	<b>List Price</b>	<b>OEM Part #</b>
			C3619CM	\$24.80	EC2200032AFM	Outer Clutch Cover Gasket	\$11.18	11061-1201
					EC2202032AFM	Mag Cover Gasket	\$13.62	11061-1200



# MX/Dirt • Off-Road Gaskets



Cometic Gasket - An Exclusive NASCAR Performance® Product

## KAWASAKI KLX300R

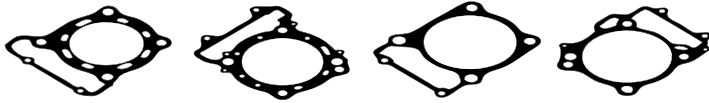

Head Head Base Base

Model	Year	Bore Size	Top End Kit	List Price	Component Part#	Component Description	List Price	OEM Part #
KLX300R	97-05	78 mm	C7302	\$27.89	H0252043F	Head Gasket 78mm	\$24.75	11004-1314
		80 mm	C7420	\$27.89	H0521043F	Head Gasket 80mm	\$24.75	
					B0260020RC	Base Gasket	\$6.25	11060-1740

## KAWASAKI KX450F



Head Base Inner Clutch Generator Cover Exhaust Water Pump Cam Chain Tensioner Outer Clutch

Model	Year	Bore Size	EST Top End Kit	List Price	Component Part#	Component Description	List Price	OEM Part #
KX450F	06-08	96 mm	C3136-EST	\$69.14	H2466027S	Head Gasket 96.5mm	\$43.54	11004-0045
		98 mm	C3146-EST	\$69.14	H2466SP1027S	Head Gasket 98mm	\$43.54	11004-0045
					B0842014RC	Base Gasket	\$11.81	11061-0160
					EX693064AM	Exhaust Gasket	\$2.56	11061-0082
					EC1080032AFM	Cam Tensioner Gasket	\$2.33	11061-0260
					R022B	Spark Plug O-Ring	\$1.13	11061-0079
					R10X2V	Cam Chain Tensioner O-Ring	\$1.59	670D2010
					3241V	Valve Stem Seals 4 Req	\$3.46	92049-1062

Bottom End Kit w/Oil Seals	List Price	Component Part#	Component Description	List Price	OEM Part #
C3136BE	\$91.63	R10X2B	Cam Chain O-ring	\$1.59	670D2010
		R010B	Oil Nozzle O-ring 7mm	\$0.62	670D1507
		WA108	Drain Plug Washer	\$2.56	92065-058
		R123V	Crankshaft Timing O-Ring	\$2.45	92055-091
		R014V	Timing Plug O-ring	\$1.08	92055-1011
		EC1067032AFM	Outer Clutch Cover Gasket	\$10.73	11061-0145
		R118B	Crankcase Oil Fill O-Ring	\$1.13	92055-1146
		EC1068032AFM	Inner Clutch Cover Gasket	\$7.44	11061-0224
		R123V	Neutral Switch O-Ring	\$2.45	92055-091
		R138SB	Oil Filter O-Ring 2 Req	\$5.71	92055-1577
		R10X2B	Oil Pickup O-ring	\$1.59	670D2010
		WP187032AFM	Water Pump Gasket	\$4.72	11061-0225
Oil Seal Kit	List Price	Component Part#	Component Description	List Price	OEM Part #
C3136OS	\$25.84	OS295	Output Shaft Seal 30x40x7	\$9.89	92049-0030
		OS339	Clutch Release Oil Seal 12X20X5.5	\$2.59	92049-1475
		OS331	Shift Shaft Seal 13x22x5.5	\$3.71	92051-005
		OS227	Inner Water Pump Seal 12x22x5	\$2.67	92049-0041
		OS277	Outer Water Pump Seal 12x24x7	\$1.48	92049-0040
		OS285	Kickstart Shaft Seal 20x30x7	\$1.48	92049-1261
		OS275	Crank End Oil Seal 10x20x5	\$4.02	92049-1542
Clutch & Mag Kit	List Price	Component Part#	Component Description	List Price	OEM Part #
C3136CM	\$23.72	EC1067032AFM	Clutch Cover Gasket	\$10.73	11061-0145
		EC1081018AFM	Mag Cover Gasket	\$12.99	11061-0084



# MX/Dirt • Off-Road Gaskets



Cometic Gasket - An Exclusive NASCAR Performance® Product

## KAWASAKI KX450F

Model	Year	Bore Size	EST	List Price	Component Part#	Component Description	List Price	OEM Part#					
KX450F	09-15	96mm 98mm	<b>Top End Kit</b> C3268-EST C3285-EST	\$69.14 \$69.14	H2466027S	Head Gasket 96.5mm	\$43.54	11004-0045/ 110040088					
					H2466SP1027S	Head Gasket 98mm	\$43.54						
					B0966014RC	Base Gasket	\$11.81	11061-0353/11061-0768					
					EX693064AM	Exhaust Gasket	\$2.56	11061-0082					
					EC1080032AFM	Cam Tensioner Gasket	\$2.33	11061-0211					
					R022B	Spark Plug O-Ring	\$1.13	11061-0079					
					R10X2V	Cam Chain Tensioner O-Ring	\$1.59	670D2010					
					3241V	Valve Stem Seals 4 Req	\$3.46	92045-1062					
					<b>Bottom End Kit w/Oil Seals</b>								
					C3268BE	\$98.69	R020V	Output Shaft O-ring	\$1.19	92055-1293			
		R013V	Temp Sensor O-ring	\$1.08	92055-0016								
		R010B	Oil Nozzle O-ring 7mm	\$0.62	670D1507								
		R011B	Oil Nozzle O-ring 8mm	\$1.08	670D1508								
		WA118	Left Case Drain Crush Washer	\$1.88	92022-304								
		WA108	Drain Plug Crush Washer	\$2.56	92065-058								
		EC1338032AFM	Clutch Cover Gasket	\$17.84	11061-0359								
		R010B	Case Dowel O-Ring	\$0.62	92055-0113								
		R123V	Crank End Plug O-ring	\$1.19	92055-091								
		R014V	Timing Plug O-ring	\$1.08	92055-1011								
		R20X2V	Oil Fill Plug O-ring	\$3.02	92055-1146								
		R123V	Neutral Switch O-ring	\$1.19	92055-091								
		R138SB	Oil Filter O-rings	\$5.71	92055-1577								
		R10X2B	Oil Pickup O-ring	\$1.59	670D2010								
		WP187032AFM	Water Pump Gasket	\$4.72	11061-0225								
		WA118	Water Pump Drain Washer	\$1.88	92022-304								
<b>Oil Seal Kit</b>													
C3268OS	\$25.84	OS277	Outer Water Pump Seal 12x24x7	\$1.48	92049-0040								
		OS227	Inner Water Pump Seal 12x22x5	\$2.67	92049-0041								
		OS285	Kickstart Shaft Seal 20x30x7	\$1.48	92049-0134								
		OS275	Crank End Oil Seal 10x20x5	\$4.02	92049-1542								
		OS295	Output Shaft Seal 30x40x7	\$9.89	92049-0030								
		OS339	Clutch Release Oil Seal 12X20X5.5	\$2.59	92049-1475								
		OS331	Shift Shaft Seal 13x22x5.5	\$3.71	92051-005								
<b>Clutch &amp; Mag Kit</b>													
C3268CM	\$24.86	EC1184032AFM	Outer Clutch Cover Gasket	\$11.87	11061-0259								
		EC1339032AFM	Mag Cover Gasket	\$12.99	11061-0358								
<b>EST</b>													
KX450F	16-18	96mm	<b>Top End Kit</b> C3598-EST C3626-EST	\$69.14	H2466027S	Head Gasket	\$43.54	11004-0756					
					H2466SP1027S	Head Gasket 98mm	\$43.54						
					B1320014RC	Base Gasket	\$11.81	11061-0984					
					EC1080032AFM	Cam Chain Tensioner Gasket	\$2.33	11061-0260					
					R10X2V	Cam Chain Tensioner O-Ring	\$1.59	670D2010					
					R021V	Cam Tower O-ring	\$1.19	92055-0046					
					EX693064AM	Exhaust Gasket	\$2.56	11061-0082					
					3241V	Valve Stem Seals 4 Req	\$3.46	92045-1062					
					<b>Bottom End Kit w/Oil Seals</b>								
					C3598BE	\$80.72	R010B	Oil Passage O-ring 7mm	\$0.62	670D1507			
		R011B	Oil Nozzle O-ring 8mm	\$1.08	670D1508								
		R117B	Fill Plug Gasket	\$0.42	92055-1146								
		R27.5X2.5V	Timing Gear O-ring	\$2.45	92055-091								
		R27.5X2.5V	Gear Position Sensor O-Ring	\$2.45	92055-091								
		WA108	Drain Plug Crush Washer	\$2.56	92065-058								
		WA128	Water Pump Crush Washer	\$1.59	92022-304								
		R13X2V	Timing Mark O-ring	\$1.93	92055-1021								
		R13X2V	Oil Screen Oring Outer	\$1.93	92055-1021								
		R10X2V	Oil Elbow O-ring 10mm	\$1.59	670D1510								
		EC2194018AFM	Inner Clutch Cover	\$18.95	11061-0981								
		R37X2.4V	Oil Filter O-ring	\$2.75	92055-0839								
		R10X2V	Oil Screen O-ring 10mm	\$1.59	670D1510								
		R0077	Oil Pump Cover O-Ring	\$4.23	92055-074								
		WP499032AFM	Water Pump Gasket	\$4.72	11061-0983								

All Component Parts can be purchased individually.



**WARNING:** Cancer and Reproductive Harm www.P65Warnings.ca.gov





# MX/Dirt • Off-Road Gaskets



Cometic Gasket - An Exclusive NASCAR Performance® Product

## KAWASAKI KX450F

Model	Year	Bore Size	Top End Kit	List Price	Component Part#	Component Description	List Price	OEM Part #		
KX450F	16-18		C3598OS	\$31.08	OS227	Inner Water Pump Seal 12x22x5	\$2.67	92049-0783		
					OS277	Water Pump Oil Seal 12x24x7	\$1.48	92049-0782		
					OS295	Output Shaft Seal	\$9.89	92049-0030		
					OS307	Kickstart Shaft Seal 18x30x7	\$7.03	92049-013		
					OS331	Shift Shaft Seal	\$3.71	92051-005		
					OS331	Balance Shaft Seal 13x22x5.5	\$3.71	92049-0762		
					OS339	Clutch Pusrod Oil Seal	\$2.59	92049-1475		
					<b>Clutch &amp; Mag Kit</b>	<b>List Price</b>	<b>Component Part#</b>	<b>Component Description</b>	<b>List Price</b>	<b>OEM Part #</b>
					C3598CM	\$20.00	R163X2B	Outer Clutch Cover O-ring	\$2.50	92055-0833
							EC2193018AFM	Mag Cover	\$17.50	11061-0982
KX450	19		C3696	\$69.95	<b>Component Part#</b>	<b>Component Description</b>	<b>List Price</b>	<b>OEM Part #</b>		
					EC2461018AFM	Cam Chain Tensioner Gasket	\$2.08	11061-1288		
					R021V	Cam Tower O-ring	\$1.10	92055-0046		
					R22X2.5V	Water Elbow O-ring	\$2.21	92055-1081		
					R032V	Intake O-ring	\$2.99	92055-1600		
					H4637027S	Cylinder Head Gasket	\$43.54	11004-0777		
					B1426010RC	Cylinder Base Gasket	\$11.81	11061-1270		
					EX657	Header Gasket	\$9.37	11061-1297		
					3241V	Valve Stem Seal	\$3.20	92049-1062		
					<b>Clutch &amp; Mag Kit</b>	<b>List Price</b>	<b>Component Part#</b>	<b>Component Description</b>	<b>List Price</b>	<b>OEM Part #</b>
					C3696CM	\$12.04	EC2444018AFM	Mag Cover	\$17.50	
							R163X2B	163mm x 2mm Buna O-Ring	\$2.50	

## KAWASAKI KX450

Model	Year	Bore Size	Top End Kit	List Price	Component Part#	Component Description	List Price	OEM Part #					
KX500 B2, 86-88 C1		88 mm	C7045	\$34.35	H0036043F	Head Gasket 88mm	\$22.32	11004-1140					
					B0035020F	Base Gasket	\$7.16	11009-1537					
					IR008018AFM	Intake Gasket	\$3.80	11009-1950					
					PV014018AFM	Right Power Valve Gasket	\$3.80	11009-1960					
					R136V	Exhaust O-Ring 2 Req	\$1.19						
					<b>Component Part#</b>	<b>Component Description</b>	<b>List Price</b>	<b>OEM Part #</b>					
KX500 E1, 89-90 E2		88 mm	C7046	\$37.84	H0037043F	Head Gasket 88mm	\$22.32	11004-1186					
					B0036018AFM	Base Gasket	\$7.16	11009-1758					
					B0036012F	High Compression Base Gasket	\$9.32						
					IR008018AFM	Intake Gasket	\$3.80	11009-1252					
					PV013018AFM	Front Power Valve Gasket	\$3.80	11009-1701					
					PV014018AFM	Right Power Valve Gasket	\$3.80	11009-1539					
					R136V	Exhaust O-Ring 2 Req	\$1.19	671E2550					
					<b>Component Part#</b>	<b>Component Description</b>	<b>List Price</b>	<b>OEM Part #</b>					
					<b>Crank Seal Kit</b>	<b>List Price</b>	<b>Component Part#</b>	<b>Component Description</b>	<b>List Price</b>	<b>OEM Part #</b>			
					C7659	\$19.22	OS135	Left/Right Oil Seal 2 Req.	\$10.68	92050-057			
KX500 E3, 91-04 T2, R2		88 mm	C7047	\$43.26	H0306010S	Head Gasket 88mm	\$22.32	11004-1209					
					B0036018AFM	Base Gasket	\$7.16	11060-1874					
					B0036012F	High Compression Base Gasket	\$7.16						
					IR008018AFM	Intake Gasket	\$3.80	11009-1950					
					PV013018AFM	Front Power Valve Gasket	\$3.80	11009-1948					
					PV014018AFM	Right Power Valve Gasket	\$3.80	11009-1960					
					R136V	Exhaust O-Ring 2 Req	\$1.19	671E2550					
					<b>Component Part#</b>	<b>Component Description</b>	<b>List Price</b>	<b>OEM Part #</b>					
					KX 500	86-04		C7046BE	\$74.84	WA108	Drain Plug Crush Washer	\$2.56	92065-058
										WP048018AFM	Water Pump Gasket	\$3.80	11009-1962
WP050032AFM	Water Pump Outlet Gasket	\$2.44	11009-1952										
WA128	Water Pump Crush Washer	\$1.59	92022-304										
R5.5X1.5B	Water Pump Governor O-ring	\$2.19	92055-1343										
<b>Component Part#</b>	<b>Component Description</b>	<b>List Price</b>	<b>OEM Part #</b>										
<b>Oil Seal Kit</b>	<b>List Price</b>	<b>Component Part#</b>	<b>Component Description</b>	<b>List Price</b>						<b>OEM Part #</b>			
C7046OS	\$49.99	OS135	Crank Seals	\$10.68						92050-057			
		OS239	Starter Oil Seal 20x28x5	\$2.60						92049-012			
		OS306	Clutch Actuator Seal	\$2.91						92049-1262			
		OS331	Shift Shaft Seal	\$3.71						92051-005			
		OS339	Clutch Pushrod Seal 1986	\$2.59						92049-004			
		OS361	Water Pump Seal 8x18x10	\$9.43						92049-1366			
		OS362	Power Valve Governor Seal	\$4.51						92049-1207			
		OS390	Output Shaft Seal 32x45x7	\$3.05						92049-1159			
<b>Clutch &amp; Mag Kit</b>	<b>List Price</b>	<b>Component Part#</b>	<b>Component Description</b>	<b>List Price</b>	<b>OEM Part #</b>								
C7045CM	\$22.61	EC255018AFM	Mag Cover Gasket	\$12.39	11009-1964								





# MX/Dirt • Off-Road Gaskets



Cometic Gasket - An Exclusive NASCAR Performance® Product

## KAWASAKI KLX650

Model	Year	Bore Size	Top End Kit	List Price	Component Part#	Component Description	List Price	OEM Part #
KLX650,	93-97	100 mm	C7246	\$38.33	H0259043F	Head Gasket 103mm	\$30.95	11004-1158
KLX650R					B0166020RC	Base Gasket	\$8.75	11060-1110

## KTM 50

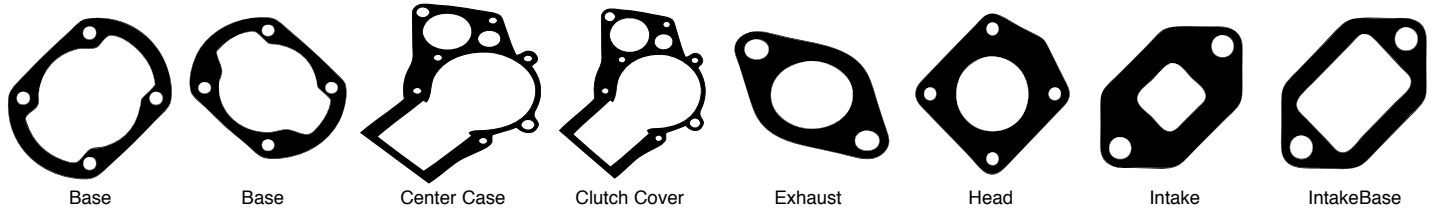

Model	Year	Bore Size	Top End Kit	List Price	Component Part#	Component Description	List Price	OEM Part #
50 Mini,	94-01	41 mm	C7282	\$31.91	H0354010C	Head Gasket .010" Copper	\$9.37	36330036000
Junior & Senior Adventure					H0354020C	Head Gasket .020" Copper	\$9.37	36330036000
					B0219018AFM	Base Gasket 00-01	\$4.65	45030035800
					B0220018AFM	Base Gasket 94-99	\$4.65	36330030000
					IR054018AFM	Intake Port Small Opening	\$3.80	49130438000
					IR055018AFM	Intake Port Large Opening	\$3.80	49130438000
					EX089039F	Exhaust Gasket	\$4.77	45030046000
			<b>Bottom End Kit w/o Crank Seals</b>	<b>List Price</b>	<b>Component Part#</b>	<b>Component Part#</b>	<b>List Price</b>	<b>OEM Part#</b>
			C3381	\$8.16	EC073015F	Center Case Gasket	\$4.54	45030039000
					EC074032AFM	Clutch Cover Gasket	\$4.54	45030025000

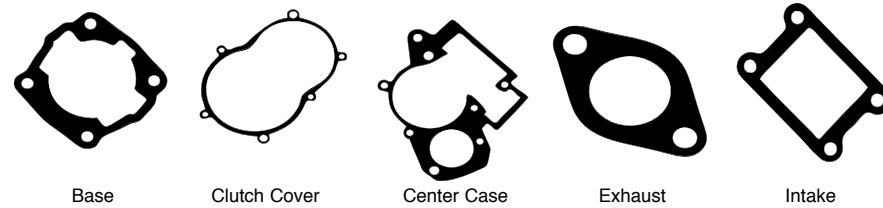

Model	Year	Bore Size	Top End Kit	List Price	Component Part#	Component Description	List Price	OEM Part #
50 Mini	02-08	41 mm	C7292	\$31.91	H2287010C	Head Gasket .010" Copper	\$5.50	46030046000
Adventure					B0357032AFM	Base Gasket .032" AFM	\$6.25	46030035020
					IR115032AFM	Intake Gasket .032"	\$6.25	46030049000
					R32X3V	Exhaust Pipe O-ring	\$3.57	0770320030
			<b>Bottom End Kit w/o Crank Seals</b>	<b>List Price</b>	<b>Component Part#</b>	<b>Component Description</b>	<b>List Price</b>	<b>OEM Part #</b>
			C3382	\$17.99	EC517018AFM	Clutch Cover Gasket	\$9.32	45130025000
					EC659015F	Center Case Gasket	\$10.68	45130039000
					EC992060AFM	Oil Fill Plug Gasket	\$7.00	45130019000
					WA130	6 req. Head Seal Washers	\$1.36	0125060003

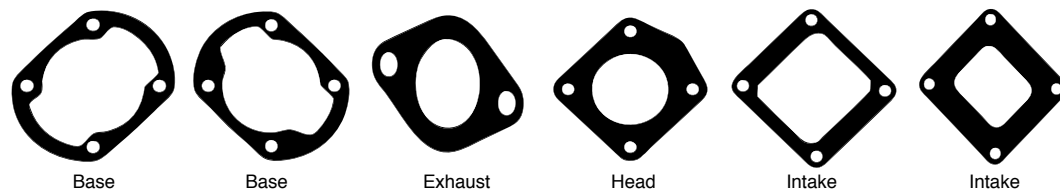

Model	Year	Bore Size	Top End Kit	List Price	Component Part#	Component Description	List Price	OEM Part #
50 SXR	97-01	43 mm	C7415	\$31.91	H1197010C	Head Gasket .010	\$9.37	36330036000
Pro Jr/Sr					H1197020C	Head Gasket .020	\$9.37	36330036000
					B0219018AFM	Base Gasket 99-01	\$4.65	36330030000
					B0220018AFM	Base Gasket 94-98	\$4.65	45030035800
					IR109018AFM	Intake to Reed Gasket	\$3.80	45030057800
					IR110018AFM	Intake to Case Gasket	\$3.80	45030049900
					EX175060F	Exhaust Gasket	\$4.77	45030046800

All Component Parts can be purchased individually.

**WARNING:** Cancer and Reproductive Harm [www.P65Warnings.ca.gov](http://www.P65Warnings.ca.gov)



# MX/Dirt • Off-Road Gaskets



Cometic Gasket - An Exclusive NASCAR Performance® Product

## KTM 50LC PROJ/SR

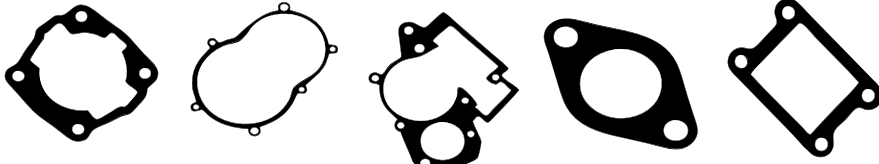

Model	Year	Bore Size	Top End Kit	List Price	Component Part#	Component Description	List Price	OEM Part #				
50 LC Pro Jr/Sr	01-01	O-Ring	C7863	\$36.86	R034V	Inner Head O-ring	\$3.00	46030037000				
					R044B	Outer Head O-ring	\$2.14	46030036000				
					WA130	6 Req. Head Seal Washers	\$1.36	0125060003				
					B0357012F	Base Gasket .012	\$6.25	46030035020				
					B0357018AFM	Base Gasket .018	\$6.25	45130025000				
					IR115018AFM	Intake Gasket	\$6.25	45130039000				
					EX089039F	Exhaust Flange Gasket	\$4.77	46030049000				
					R32X3V	Exhaust Pipe O-ring	\$3.57	0770320030				
						<b>Bottom End Kit w/o Crank Seals</b>	<b>List Price</b>					
						C3383	\$22.82	EC517018AFM	Clutch Cover	\$9.32	45130025000	
								EC659015F	Center Case Gasket	\$10.68	45130039000	
								EC992060AFM	Oil Fill Plug Gasket	\$1.13	45130019000	
			WA129	Case Drain Crush Washer	\$0.95	0603100141						
			WA133	10mm x 14mm x 2mm Clutch & Water Pump Drain Crush washers 2 Req.	\$0.90	0603061001						
50 SX Pro Senior LC	02-08	O-Ring	C7295	38.33	R53.5X2V	Inner Head O-ring	\$3.07	46030036000				
					R95X2V	Outer Head O-ring	\$4.00	46030037000				
					WA130	Head Crush Washer 5 Req.	\$1.36	50230032010				
					B0357032AFM	Base Gasket	\$6.25	46030035020				
					IR115032AFM	Intake Gasket	\$6.25	46030049000				
					EX175060F	Exhaust Gasket	\$4.77	46030046000				
						<b>Bottom End Kit w/o Crank Seals</b>	<b>List Price</b>					
						C3383	22.82	EC517018AFM	Clutch Cover	\$9.32	45130025000	
								EC659015F	Center Case Gasket	\$10.68	45130039000	
								EC992060AFM	Oil Fill Plug Gasket	\$1.13	45130019000	
								WA129	Case Drain Crush Washer	\$0.95	0603100141	
								WA133	Clutch & Water Pump Drain Crush Washers 2 Req.	\$0.90	0603061001	



# MX/Dirt • Off-Road Gaskets



Cometic Gasket - An Exclusive NASCAR Performance® Product

## KTM 50SX LC

Model	Year	Bore Size	Top End Kit	List Price	Component Part#	Component Description	List Price	OEM Part #
50SX LC	09-19	O-Ring	C3503	\$28.94	R52X2V	Inner Head O-ring	\$3.36	0770052020
					R78X2V	Outer Head O-ring	\$4.29	0770078020
					WA130	Head Crush Washer 5 Req. 7.5mm x 12mm x .5mm	\$1.36	50230032010
					EX14B043F	Exhaust Gasket	\$5.75	45205004000
					B0976018AFM	Base Gasket	\$6.25	46230035040
			<b>Bottom End Kit w/Oil Seals</b>	<b>List Price</b>	<b>Component Part#</b>	<b>Component Description</b>	<b>List Price</b>	<b>OEM Part #</b>
			C3503BE	\$72.16	EC2180018AFM	Inner Clutch Cover Gasket	\$10.68	4523002500
					EC2179020F	Center Case Gasket	\$10.68	45230039000
					R19X3V	Fill Plug O-ring	\$3.02	0770191015
					IR747018AFM	Intake Gasket	\$4.37	46230049000
					WP496	Water Pump O-ring	\$3.25	45235053000
					WA137	Trans Drain Plug Seal	\$1.53	58038022000
					WA133	Coolant Drain Plug Seal	\$0.90	0603061001
					R017B	Output Shaft O-ring	\$1.14	0770015018
					WA133	Water Pump Drain Seal	\$0.90	0603061001
			<b>Oil Seal Kit</b>	<b>List Price</b>	<b>Component Part#</b>	<b>Component Description</b>	<b>List Price</b>	<b>OEM Part #</b>
			C3503OS	\$35.85	OS202	Outer Water Pump Seal 8x24x7	\$7.56	760082472
					OS206	Left Crank Seal 15x24x7	\$13.49	760152472
					OS209	Kickstart Shaft Seal 16x22x4	\$3.19	760162240
					OS252	Output Shaft Seal 22x32x7	\$7.59	760223270
					OS389	Right Crank Seal 26x35x6	\$4.79	760263561
			<b>Clutch &amp; Mag Kit</b>	<b>List Price</b>	<b>Component Part#</b>	<b>Component Description</b>	<b>List Price</b>	<b>OEM Part#</b>
			C3503CM		R110X2B	Outer Clutch Cover O-ring	\$2.86	45230027000
					EC1572032AFM	Mag Cover Gasket	\$3.18	45230040000

## KTM 65SX

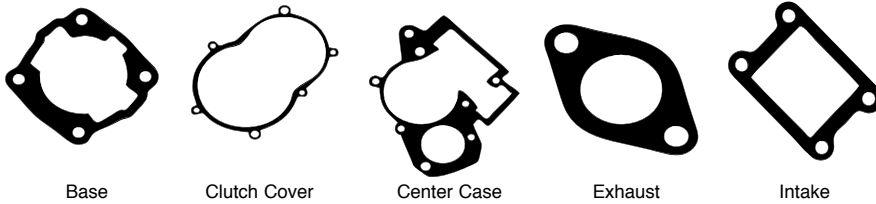

Model	Year	Bore Size	Top End Kit	List Price	Component Part#	Component Description	List Price	OEM Part #
65 SX	98-01	O-Ring	C7416	\$35.72	R034V	Inner Head O-ring	\$3.00	46030036000
					R044B	Outer Head O-ring	\$2.14	46030037000
					B0357012F	Base Gasket .012"	\$6.25	46030035020
					B0357018AFM	Base Gasket .018"	\$6.25	46030035020
					IR115018AFM	Intake Reed Gasket	\$6.25	46030049000
			<b>Bottom End Kit w/o Crank Seals</b>	<b>List Price</b>	<b>Component Part#</b>	<b>Component Description</b>	<b>List Price</b>	<b>OEM Part #</b>
			C3384	\$36.35	EC447032AFM	Inner Clutch Cover	\$14.87	46030025000
					EC448020F	Crankcase Gasket	\$16.13	46030039000
					R048B	Mag Cover O-ring	\$11.34	0770020480
					WP106032AFM	Water Pump Gasket	\$2.16	45135053000

All Component Parts can be purchased individually.

**WARNING:** Cancer and Reproductive Harm [www.P65Warnings.ca.gov](http://www.P65Warnings.ca.gov)





# MX/Dirt • Off-Road Gaskets



Cometic Gasket - An Exclusive NASCAR Performance® Product

## KTM 65SX

Model	Year	Bore Size	Top End Kit	List Price	Component Part#	Component Description	List Price	OEM Part #						
65 SX	02-08	O-Ring	C7333	\$38.33	R54X2V	Inner Head O-ring	\$4.14	46030036000						
					R95X2V	Outer Head O-ring	\$4.00	46030037000						
					WA130	Head Crush Washer 5 Req.	\$1.36	50230032010						
					B0357018AFM	Base Gasket .018"	\$6.25	46030035020						
					B0357032AFM	Base Gasket .032"	\$6.25	46030035020						
					IR115032AFM	Intake Gasket	\$6.25	46030049000						
					EX921059F	Exhaust Gasket	\$4.77	46030046000						
					Bottom End Kit C7333BE	\$49.61	Component Part#	Component Description	List Price	OEM Part #	WP106032AFM	Water Pump Gasket	\$2.16	45135053000
											R16X3V	Clutch Fill Plug O-ring	\$1.26	0770160030
											WA129	Case Drain Crush Washer 10mm x 14mm x 2mm	\$0.95	0603101420
			EC448020F	Crankcase Gasket							\$16.13	46030039000		
			R30X1.5V	Clutch Slave Cylinder O-ring							\$2.29	0770300015		
			Oil Seal Kit C7333OS	\$32.99	Component Part#	Component Description	List Price	OEM Part #	OS197	Start Shaft Seal 14x24x6	\$2.46	0760142460		
									OS339	Shift Shaft Seal 12x20x5	\$2.49	0760122050		
									OS389	Output Shaft Seal 26x35x6	\$4.79	0760263560		
									OS208	Impeller Seal 10X18X4		46035056100		
									OS199	Crank Seals 20x35x6	\$17.45	47030076100		
			Clutch & Mag Kit C7333CM	\$26.21	Component Part#	Component Description	List Price	OEM Part #	R048B	Mag Cover O-ring 2002	\$11.34	0770020480		
									EC447032AFM	Inner Clutch Cover	\$14.87	46030025000		
65 SX	09-19	O-Ring	C3416	\$35.51	MR106	Cylinder Head Gasket	\$6.90	45230036000						
					WA146	Head Crush Washer 4 Req.	\$2.16	50230032010						
					B0976018AFM	Cylinder Base Gasket	\$6.25	46230035040						
					EX943059F	Header Flange Gasket	\$4.77	46205004000						
					R20X2V	Power Valve Control O-ring	\$3.02	770150151						
					R005B	Power Valve Base Orings 2 Req.	\$0.11	770030015						
					WA133	Power Valve Base Seal Washer	\$0.90	603061001						
					WA133	Power Valve Copper Seal	\$0.90	603050901						
					IR747018AFM	Reed Valve Gasket	\$4.37	46230049000						
					Bottom End Kit C3416BE	\$49.99	Component Part#	Component Description	List Price	OEM Part #	EC1357020F	Center Case Gasket	\$16.13	46230039000
											WA133	Coolant Drain Plug	\$0.90	603061001
											WA137	Trans Drain Plug Crush washer	\$1.53	58038022000
											EC2204018AFM	Primary Cover Gasket	\$9.32	46230025100
											R19X3V	Fill Plug O-ring	\$3.02	770191015
											R16X2V	Crank Back up O-ring	\$3.02	770160021
IR747018AFM	Intake Gasket	\$4.37	46230049000											
EC1360018AFM	Slave Cylinder Gasket	\$4.37	59032065000											
R027V	Slave Cylinder O-ring	\$1.10	770031018											
R20X2V	Countershaft Back Up Ring	\$3.02	770020020											
Oil Seal Kit C3416OS	\$32.99	Component Part#	Component Description	List Price	OEM Part #	WP496	Water Pump Gasket	\$18.25	45235053000					
						OS294	Right Crank Seal 30x47x7	\$16.79	760304772					
						OS199	Left Crank Seal 20x35x6	\$17.45	47030076100					
						OS389	Countershaft Seal 26x35x6	\$4.79	760263561					
						OS357	Start Shaft Seal 17x28x6	\$5.07	760172860					
						OS339	Shift Shaft Seal 12x20x5	\$2.59	760122050					
						OS202	Water Pump Seal 8x24x7	\$7.56	760082472					
Clutch & Mag Kit C3416CM	\$18.61	Component Part#	Component Description	List Price	OEM Part #	MR162	Clutch Cover O-ring	\$9.29	46230027000					
						EC1358032AFM	Mag Cover Gasket	\$9.32						



# MX/Dirt · Off-Road Gaskets



Cometic Gasket - An Exclusive NASCAR Performance® Product

## KTM 85SX

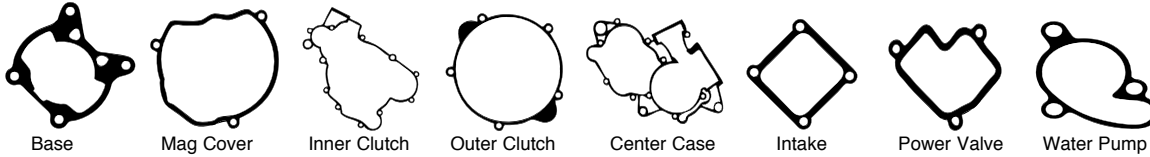

Model	Year	Bore Size	Top End Kit	List Price	Component Part#	Component Description	List Price	OEM Part #
85 SX	04-12	O-Ring	C7384	\$38.33	R54X2V	Inner Head O-ring	\$4.14	0770 540020
					R82X2V	Outer Head O-ring	\$5.14	0770 820020
					R22X2.5V	Head Insert O-ring	\$2.21	0770 220025
					WA133	Head Seal Crush Washers 6 Req.	\$0.90	0603061001
					B0801032AFM	Base Gasket	\$7.16	47030035000
					WA134	Exhaust Valve Seal Crush Washer	\$0.80	0603040801
					PV126032AFM	Power Valve Side Cover Gasket	\$4.72	47037008000
					R12X2V	Exhaust Control Valve O-ring	\$4.09	0770120020
					R8X1.5V	Exhaust Valve Linkage O-ring	\$0.59	0770008015
					IR530032AFM	Intake Gasket	\$4.72	47030049000
					R22X2V	Exhaust Valve Cover O-ring	\$2.66	0770020200
					R38X3V	Exhaust Pipe Header O-rings 2 req.	\$3.79	0770380030
			<b>Bottom End Kit w/o Crank Seals</b>	<b>List Price</b>	<b>Component Part#</b>	<b>Component Description</b>	<b>List Price</b>	<b>OEM Part #</b>
			C3386	\$38.43	EC986032AFM	Mag Cover Gasket	\$3.18	47030040000
					EC987032AFM	Inner Clutch Cover Gasket	\$7.49	47030025000
					EC988032AFM	Outer Clutch Cover Gasket	\$5.11	47030027000
					EC989020F	Crankcase Gasket	\$10.17	47030039000
					R16X3V	Oil Fill Plug Gasket	\$1.26	0770160030
					R19X2V	Output Shaft O-ring	\$2.50	46033031000
					R30X1.5V	Clutch Slave Cylinder O-ring	\$2.29	0770300015
					WA133	Water Pump Seal Crush Washer	\$0.90	0603061001
					WP174032AFM	Water Pump Gasket	\$4.72	47035053000
			<b>Clutch &amp; Mag Kit</b>	<b>List Price</b>	<b>Component Part#</b>	<b>Component Description</b>	<b>List Price</b>	<b>OEM Part #</b>
			C7384CM	\$8.29	EC988032AFM	Clutch Cover Gasket	\$5.11	47030027000
					EC986032AFM	Mag Cover Gasket	\$3.18	47030040000
85 SX	13-17	O-Ring	<b>Top End Kit</b>	<b>List Price</b>	<b>Component Part#</b>	<b>Component Part#</b>	<b>List Price</b>	<b>OEM Part#</b>
			C3510	\$28.63	R54X2V	Inner Head O-ring 54X2	\$4.14	0770540020
					R80X2S	Outer Head O-ring 80X2	\$5.29	0770800021
					PV143018AFM	Right Power Valve Gasket	\$3.59	47137008000
					WA133	Copper Head Crush Washer	\$0.90	0603061001
					B0801032AFM	Base Gasket .2mm	\$7.16	47030035020
					R12X2V	Power Valve Control O-ring Left 12x2	\$4.09	0770120020
					R8X1.5V	Power Valve Control O-ring Right 8x1.5	\$0.59	0770008015
					R22X2V	Power Valve Control Cover O-ring	\$2.66	0770020200
					R38X3V	Exh. Pipe Header O-rings 2 req	\$3.79	0770380030
			<b>Bottom End Kit</b>	<b>List Price</b>	<b>Component Part#</b>	<b>Component Part#</b>	<b>List Price</b>	<b>OEM Part#</b>
			C3517	\$38.43	EC989020F	Center Case Gasket	\$10.17	47030039000
					EC987032AFM	Inner Clutch Cover Gasket	\$7.49	47030025000
					EC1849032AFM	Outer Clutch Cover Gasket	\$5.11	47030027100
					R16X3V	Oil Fill Plug O-ring	\$1.26	0770160030
					WA129	Drain Plug gasket	\$0.95	0603101420
					WP429018AFM	Water Pump Cover Gasket	\$4.72	47035053000
					WA133	Water Pump Cover Drain Washer	\$0.90	0603061001
					IR530032AFM	Intake Gasket	\$4.72	47030049000
					R027V	Slave Cylinder O-ring	\$1.19	0770031018

All Component Parts can be purchased individually.

**WARNING:** Cancer and Reproductive Harm www.P65Warnings.ca.gov



# MX/Dirt • Off-Road Gaskets



Cometic Gasket - An Exclusive NASCAR Performance® Product

## KTM 85SX

Model	Year	Bore Size	Top End Kit	List Price	Component Part#	Component Description	List Price	OEM Part #
85 SX	18-19	O-ring	C3636	\$36.81	WA133	Head Crush Washers	\$0.90	603061001
					R23X2.5V	Dome O-ring	\$1.65	7702300251
					R54X2V	Inner Chamber O-ring	\$4.14	770540020
					R80X2S	Outer Chamber O-ring	\$5.29	770800021
					PV158018AFM	Right Power Valve Cover Gasket		47237008000
					PV157018AFM	Left Power Valve Cover Gasket		47237006000
					B1408	Base Gasket	\$7.16	47230035020
					B1408010RC	Base Gasket		47230035025
					B1408014RC	Base Gasket		47230035040
					B1408020RC	Base Gasket		47230035050
					B1408031F	Base Gasket		47230035075
					WA133	Power Valve Cover Crush Washer	\$0.90	603061001
					R8X2V	Power Valve Flap O-ring	\$1.59	770080201
					R114V	Power Valve Spring Cover	\$1.10	770021120
					R24X2V	Power Valve Spring Cover	\$6.19	770240020

## KTM 105SX

Model	Year	Bore Size	Top End Kit	List Price	Component Part#	Component Description	List Price	OEM Part #
105 SX	07-11	O-Ring	C3552	\$28.63	MR124	Inner Head O-ring	\$8.99	47530006000
					R80X2S	Outer Head O-ring 80X2	\$5.29	0770800021
					PV143018AFM	Right Power Valve Gasket	\$3.59	47137008000
					WA133	Copper Head Crush Washer	\$0.90	0603061001
					B0801032AFM	Base Gasket .2mm	\$7.16	47030035020
					R12X2V	Power Valve Control O-ring Left 12x2	\$4.09	0770120020
					R8X1.5V	Power Valve Control O-ring Right 8x1.5	\$0.59	0770008015
					R22X2V	Power Valve Control Cover O-ring	\$2.66	0770020200
					R38X3V	Exhaust Pipe Header O-rings 2 req.	\$3.79	0770380030

Model	Year	Bore Size	Top End Kit	List Price	Component Part#	Component Description	List Price	OEM Part #
105 Supermini	18-19	O-ring	C3637	\$36.81	WA133	Head Crush Washers	\$0.90	603061001
					R23X2.5V	Dome O-ring	\$1.65	7702300251
					R60X2V	Inner Chamber O-ring	\$4.14	770600200
					R80X2S	Outer Chamber O-ring	\$5.29	770800021
					PV158018AFM	Right Power Valve Cover Gasket	\$3.59	47237008000
					PV157018AFM	Left Power Valve Cover Gasket	\$3.59	47237006000
					B1408	Base Gasket	\$7.16	47230035020
					B1408010RC	Base Gasket		47230035025
					B1408014RC	Base Gasket		47230035040
					B1408020RC	Base Gasket		47230035050
					B1408031F	Base Gasket		47230035075
					WA133	Power Valve Cover Crush Washer	\$0.90	603061001
					R8X2V	Power Valve Flap O-ring	\$1.59	770080201
					R114V	Power Valve Spring Cover	\$1.10	770021120
					R24X2V	Power Valve Spring Cover	\$6.19	770240020

**All Component Parts can be purchased individually.**



**WARNING:** Cancer and Reproductive Harm [www.P65Warnings.ca.gov](http://www.P65Warnings.ca.gov)



# MX/Dirt · Off-Road Gaskets



Cometic Gasket - An Exclusive NASCAR Performance® Product

## KTM 125SX

Model	Year	Bore Size	Top End Kit	List Price	Component Part#	Component Description	List Price	OEM Part #					
125 SX, EXC	93-96	O-Ring	C7097	\$31.91	R60X2V	Inner Head O-ring	\$4.84	50230095000					
					H0377043F	Head Gasket Outer	\$17.38	50230036500					
					B0228018AFM	Base Gasket .018" AFM	\$6.25	50230030020					
					B0228032AFM	Base Gasket .032" AFM	\$6.25	50230030030					
					PV048018AFM	Power Valve Gasket	\$3.80	50237006000					
					<b>Crank Seal Kit</b>	<b>List Price</b>	<b>Component Part#</b>	<b>Component Description</b>	<b>List Price</b>	<b>OEM Part#</b>			
					C7660	\$28.81	OS138	29X43X6 Right Side Crank Seal	\$15.99	760304260			
							OS139	24X40X7 Left Side Crank Seal	\$15.99	760254070			
					<b>Top End Kit</b>	<b>List Price</b>	<b>Component Part#</b>	<b>Component Description</b>	<b>List Price</b>	<b>OEM Part #</b>			
					C7456	\$31.91	H0755043F	Head Gasket Outer	\$16.13	50330037000			
125 SX, EXC	98-01	O-Ring	C7456	\$31.91	R72X2V	Inner Head O-ring	\$3.57	0770720021					
					B0338018AFM	Base Gasket .018"	\$9.32	50330035040					
					B0338032AFM	Base Gasket .032"	\$9.32	50330035075					
					EC449032AFM	Exh. Intermediate Gasket 00-04	\$6.02	50337046100					
					EC544032AFM	Exh. Intermediate Gasket 98-99	\$6.02	50337046000					
					PV075032AFM	Rt. Side Power Valve Cover	\$2.44	50337006000					
					PV076032AFM	Center Power Valve Cover	\$2.44	50337035050					
					PV077032AFM	Left Side Power Valve Cove	\$2.44	50337008000					
					125 SX	97-03	O-Ring	C7386	\$38.33	R0047	Outer Head O-ring	\$13.94	50330137000
										R62X2V	Inner Head O-ring	\$4.64	0770062020
WA130	Head Seal Crush Washers 6 Req.	\$1.36	50230032010										
B0338018AFM	Base Gasket .018"	\$9.32	50330035025										
B0338032AFM	Base Gasket .032"	\$9.32	50330035040										
PV075032AFM	Left Side Power Valve Gasket	\$2.44	50337008000										
PV076032AFM	Right Side Power Valve Gasket	\$2.44	50337006000										
PV077032AFM	Power Valve Cover Gasket	\$2.44	50337035050										
EC449032AFM	Intermediate Exhaust Gasket	\$6.02	50337046100										
R8X2V	Power Valve Axle O-ring	\$1.13	0770008020										
R44X3S	Exp. Chamber O-rings 2 Req.	\$2.82	0770440030										
125 SX	98-15		C7386BE	\$71.99	<b>Bottom End Kit</b>	<b>List Price</b>	<b>Component Part#</b>	<b>Component Description</b>	<b>List Price</b>	<b>OEM #</b>			
					EC446020F	Center Case Gasket	\$16.13	50330039000					
					WA137	Drain Plug Gasket 12X18X1.5	\$1.53	58038022000					
					EC441032AFM	Primary Cover Gasket	\$16.13	50330025000					
					R19X3V	Fill Plug O-ring 19x3	\$3.02	0770191015					
					WA129	Primary Drain Plug Gasket 10x14x1	\$0.95	0603100141					
					WA133	Sight Plug Gasket 6x10x1	\$0.90	0603061001					
					WA129	Water Pump Drain Plug O-ring 10X14X1	\$0.95	0603100141					
					R16X3V	Water Pump Cover O-ring 16x3	\$1.26	0770160030					
					R25X2V	Crank Backup Oring 25x2	\$3.21	0770250020					
IR1355032AFM	Reed Cage Gasket	\$4.37	50330098050										
EC443012F	Clutch Release Gasket .3	\$2.56	50332065051										
EC443032AFM	Clutch Release Gasket .5	\$2.56	50332065052										
EC443062F	Clutch Release Gasket .75	\$2.56	50332065053										
WA129	Bleeder Screw Crush Seal 10x16x1	\$0.95	42013226000										
R23X2V	Output Shaft Backup O-ring 23x2	\$4.09	0770230020										
R49X2.5V	Water Pump Support Bushing O-ring 49x2.5	\$3.14	0770049025										
<b>Oil Seal Kit</b>	<b>List Price</b>	<b>Component Part#</b>	<b>Component Description</b>	<b>List Price</b>	<b>OEM #</b>								
C7386OS	\$43.11	OS202	Water Pump Shaft Seal 8x24x7	\$7.56	0760082472								
		OS203	Start Shaft Seal 17x28x7	\$3.26	0760172870								
		OS197	Shift Shaft Seal 14x24x6	\$2.46	0760142460								
		OS390	Output Shaft Seal 32x45x7	\$3.05	0760324571								
		OS141	Right Crank Seal 32x45x6.5	\$15.99	0760324564								
		OS217	Left Crank Seal 25x35x7	15.59	0760253570								
<b>Clutch &amp; Mag Kit</b>	<b>List Price</b>	<b>Component Part#</b>	<b>Component Description</b>	<b>List Price</b>	<b>OEM #</b>								
C7386CM	\$25.91	EC236060AFM	Outer Clutch Cover Gasket	\$12.39	50330027000								
		EC442060AFM	Mag Cover 98-08	\$13.52	50330040000								

All Component Parts can be purchased individually.

**WARNING:** Cancer and Reproductive Harm www.P65Warnings.ca.gov



# MX/Dirt • Off-Road Gaskets



Cometic Gasket - An Exclusive NASCAR Performance® Product

## KTM 125SX

Model	Year	Bore Size	Top End Kit	List Price	Component Part#	Component Part#	List Price	OEM Part#
125 SX	07-14	O-Ring	C3211	\$42.13	R62X2V	Inner Head O-ring	\$4.64	0770062020
144 SX	07-08				R85X2V	Outer Head O-ring	\$7.14	0770086020
150 SX,XC	09-14				WA146	Head Seal Crush Washer 6 Req.	\$2.16	50330079000
					B0338018AFM	Base Gasket .018"	\$9.32	50330035025
					EX645032AFM	Intermediate Exhaust Gasket	\$6.02	50337046200
					R44X3S	Exp. Chamber O-rings 2 Req.	\$2.82	0770440030
					PV076032AFM	Left Side Power Valve Gasket	\$2.44	50337006000
					PV077032AFM	Power Valve Cover Gasket	\$2.44	50337035050
					PV135032AFM	Right Side Power Valve Gasket	\$2.44	50337008100
					R014V	Head Power Valve O-ring	\$1.08	0770012021
					R16X3V	Power Valve Bushing O-ring Seal	\$1.26	0770160030
					R8X2V	Power Valve Axle O-ring	\$1.13	0770008020
					WA131	Power Valve Control Shaft Seal	\$2.31	0603262322
					WA133	Power Valve Cover Crush Washer 3 Req.	\$0.90	0603061001

125 SX 98-15

Bottom End Kit	List Price	Component Part#	Component Description	List Price	OEM #
C7386BE	\$71.99	EC446020F	Center Case Gasket	\$16.13	50330039000
		WA137	Drain Plug Gasket 12X18X1.5	\$1.53	58038022000
		EC441032AFM	Primary Cover Gasket	\$16.13	50330025000
		R19X3V	Fill Plug O-ring 19x3	\$3.02	0770191015
		WA129	Primary Drain Plug Gasket 10x14x1	\$0.95	0603100141
		WA133	Sight Plug Gasket 6x10x1	\$0.90	0603061001
		WA129	Water Pump Drain Plug O-ring 10X14X1	\$0.95	0603100141
		R16X3V	Water Pump Cover O-ring 16x3	\$1.26	0770160030
		R25X2V	Crank Backup Oring 25x2	\$3.21	0770250020
		IR1355032AFM	Reed Cage Gasket	\$4.37	50330098050
		EC443012F	Clutch Release Gasket .3	\$2.56	50332065051
		EC443032AFM	Clutch Release Gasket .5	\$2.56	50332065052
		EC443062F	Clutch Release Gasket .75	\$2.56	50332065053
		WA129	Bleeder Screw Crush Seal 10x16x1	\$0.95	42013226000
		R23X2V	Output Shaft Backup O-ring 23x2	\$4.09	0770230020
		R49X2.5V	Water Pump Support Bushing O-ring 49x2.5	\$3.14	0770049025
Oil Seal Kit	List Price	Component Part#	Component Description	List Price	OEM #
C7386OS	\$43.11	OS202	Water Pump Shaft Seal 8x24x7	\$7.56	0760082472
		OS203	Start Shaft Seal 17x28x7	\$3.26	0760172870
		OS197	Shift Shaft Seal 14x24x6	\$2.46	0760142460
		OS390	Output Shaft Seal 32x45x7	\$3.05	0760324571
		OS141	Right Crank Seal 32x45x6.5	\$15.99	0760324564
		OS217	Left Crank Seal 25x35x7	15.59	0760253570
Clutch & Mag Kit	List Price	Component Part#	Component Description	List Price	OEM #
C7386CM	\$25.91	EC236060AFM	Outer Clutch Cover Gasket	\$12.39	50330027000
		EC442060AFM	Mag Cover 98-08	\$13.52	50330040000

Top End Kit	List Price	Component Part#	Component Description	List Price	OEM Part #
C3606	\$60.26	B1348010RC	Base Gasket	\$7.19	50430035025
		B1348014RC	Base Gasket	\$7.19	50430035040
		B1348018AFM	Base Gasket	\$7.19	50430035050
		B1348032AFM	Base Gasket	\$7.19	50430035075
		IR1355032AFM	Reed Cage Gasket	\$4.37	50430098050
		MR163	Exhaust Valve Cover Gasket	\$9.29	50437046000
		PV152032AFM	Left Side Exhaust Valve Cover	\$5.29	50437006000
		PV153032AFM	Right Side Exhaust Valve Cover	\$5.29	50437008000
		R14X2V	Power Valve Control O-rings	\$1.13	0770140201
		R23X2.5V	Dome O-ring 23x2.5	\$1.65	07702300251
		R60X2V	Inner Head O-ring 60x2	\$4.84	0770600200
		R89X2V	Outer Head O-ring 89X2	\$2.98	0770890200
		WA133	Head Drain Crush Washer 6X10X1	\$0.90	0603061001
		WA146	Cylinder Head Crush Washer 7.3X12X1 (6)	\$2.16	0603070121
		IR1356032AFM	Intake Gasket	\$4.37	50430098060

**All Component Parts can be purchased individually.**



**WARNING:** Cancer and Reproductive Harm [www.P65Warnings.ca.gov](http://www.P65Warnings.ca.gov)





# MX/Dirt · Off-Road Gaskets



Cometic Gasket - An Exclusive NASCAR Performance® Product

## KTM 125SX

Model	Year	Bore Size	Bottom End Kit w/Oil Seals	List Price	Component Part#	Component Description	List Price	OEM Part #			
125 SX	16-19		C3606BE	\$93.89	EC2182020F	Center Case Gasket	\$18.39	50430039000			
					WA137	Copper Drain Plug Crush Washer 12X18X1.5	\$1.53	58038022000			
					R19X3V	Fill Plug O-Ring 19x3	\$3.02	0770191015			
					WA133	Water Passage Crush Washer	\$0.90	0603061001			
					WA133	Clutch Drain Plug Gasket	\$0.90	0603100141			
					EC2183032AFM	Inner Clutch Cover Gasket	\$10.78	50430025000			
					R25X2V	Primary Gear Back Up Ring 25x2	\$3.21	0770250020			
					R30X1.5V	Slave Cylinder O-ring 30x1.5	\$2.29	0770300015			
					WA135	Clutch Cable Crush Washer 8x16x1	\$0.80	0603080161			
					R23X2V	Output Shaft Back Up O-ring 23x2	\$4.09	0770230020			
					WP500	Water Pump Gasket	\$8.09	50435053000			
					WA133	Water Pump Cover Drain Plug Crush Washer 6X10X1	\$0.90	0603061001			
					R114V	Power Valve Adjuster O-Ring 12.37X2.62	\$1.10	0770021120			
						<b>Oil Seal Kit</b>	<b>List Price</b>	<b>Component Part#</b>	<b>Component Description</b>	<b>List Price</b>	<b>OEM Part #</b>
						C3606OS	\$42.14	OS217	Left Crank Seal 25X35X7	\$15.59	0760253570
								OS141	Right Crank Seal 32X45X6,5	\$15.99	0760324564
								OS141	Output Shaft Seal 32X45X7	\$15.99	0760324571
								OS310	Start Shaft Seal 19X30X7	\$4.29	0760193070
								OS197	Shift Shaft Seal 14X24X6	\$2.46	0760142460
								OS202	Water Pump Seal 8x24x7	\$7.56	0760082472
								<b>Component Part#</b>	<b>Component Description</b>	<b>List Price</b>	<b>OEM Part #</b>
								R0078	Outer Clutch Cover O-ring	\$8.69	50430027000
					150 SX	16-19	O-Ring	<b>Top End Kit</b>	<b>List Price</b>	<b>Component Part#</b>	<b>Component Description</b>
C3607	\$60.26	B1348010RC	Base Gasket	\$7.19				50430035025			
		B1348014RC	Base Gasket	\$7.19				50430035040			
		B1348018AFM	Base Gasket	\$7.19				50430035050			
		B1348032AFM	Base Gasket	\$7.19				50430035075			
		IR1355032AFM	Reed Cage Gasket	\$4.37				50430098050			
		MR163	Exhaust Valve Cover Gasket	\$9.29				50437046000			
		PV152032AFM	Left Side Exhaust Valve Cover	\$5.29				50437006000			
		PV153032AFM	Right Side Exhaust Valve Cover	\$5.29				50437008000			
		R14X2V	Power Valve Control O-rings	\$1.13				0770140201			
		R23X2.5V	Dome O-ring 23x2.5	\$1.65				07702300251			
		R64X2V	Inner Head O-ring 60x2	\$4.84				0770600200			
		R89X2V	Outer Head O-ring 89X2	\$2.98				0770890200			
		WA133	Head Drain Crush Washer 6X10X1	\$0.90				0603061001			
		WA146	Cylinder Head Crush Washer 7.3X12X1 (6)	\$2.16				0603070121			
			IR1356032AFM	Intake Gasket				\$4.37	50430098060		
		<b>Bottom End Kit</b>	<b>List Price</b>	<b>Component Part#</b>				<b>Component Description</b>	<b>List Price</b>	<b>OEM Part #</b>	
		w/Oil Seals									
		C3606BE	\$93.89	EC2182020F				Center Case Gasket	\$18.39	50430039000	
				WA137				Copper Drain Plug Crush Washer 12X18X1.5	\$1.53	58038022000	
				R19X3V				Fill Plug O-Ring 19x3	\$3.02	0770191015	
				WA133				Water Passage Crush Washer	\$0.90	0603061001	
				WA133				Clutch Drain Plug Gasket	\$0.90	0603100141	
				EC2183032AFM	Inner Clutch Cover Gasket	\$10.78	50430025000				
				R25X2V	Primary Gear Back Up Ring 25x2	\$3.21	0770250020				
				R30X1.5V	Slave Cylinder O-ring 30x1.5	\$2.29	0770300015				
				WA135	Clutch Cable Crush Washer 8x16x1	\$0.80	0603080161				
				R23X2V	Output Shaft Back Up O-ring 23x2	\$4.09	0770230020				
				WP500	Water Pump Gasket	\$8.09	50435053000				
				WA133	Water Pump Cover Drain Plug Crush Washer 6X10X1	\$0.90	0603061001				
				R114V	Power Valve Adjuster O-Ring 12.37X2.62	\$1.10	0770021120				

All Component Parts can be purchased individually.



**WARNING:** Cancer and Reproductive Harm www.P65Warnings.ca.gov



# MX/Dirt • Off-Road Gaskets



Cometic Gasket - An Exclusive NASCAR Performance® Product

## KTM 150SX

Model	Year	Bore Size	Oil Seal Kit	List Price	Component Part#	Component Description	List Price	OEM Part #
150 SX	16-19		C3606OS	\$42.14	OS217	Left Crank Seal 25X35X7	\$15.59	0760253570
					OS141	Right Crank Seal 32X45X6,5	\$15.99	0760324564
					OS141	Output Shaft Seal 32X45X7	\$15.99	0760324571
					OS310	Start Shaft Seal 19X30X7	\$4.29	0760193070
					OS197	Shift Shaft Seal 14X24X6	\$2.46	0760142460
					OS202	Water Pump Seal 8x24x7	\$7.56	0760082472
					<b>Component Part#</b>	<b>Component Description</b>	<b>List Price</b>	<b>OEM Part #</b>
					R0078	Outer Clutch Cover O-ring	\$8.69	50430027000

## KTM 200SX

Model	Year	Bore Size	Top End Kit	List Price	Component Part#	Component Description	List Price	OEM Part #
200 SX, MXC, EXC	98-02	O-Ring	C7738	\$36.86	R72X2V	Inner Head O-ring	\$3.57	0770720021
					H0985043F	Outer Head Gasket	\$14.25	52330037000
					B0338018AFM	Base Gasket .018"	\$9.32	50330035040
					B0338032AFM	Base Gasket .032"	\$9.32	50330035040
					EC450032AFM	Intermediate Gasket 98-99	\$6.02	52337046000
					EC545032AFM	Intermediate Gasket 00-01	\$6.02	52337046100
					PV075032AFM	Right Side Power Valve Gasket	\$2.44	50337008000
					PV076032AFM	Left Side Power Valve Gasket	\$2.44	50337006000
					PV077032AFM	Power Valve Cover Gasket	\$2.44	50337035050
			<b>Bottom End Kit w/crank seals</b>	<b>List Price</b>	<b>Component Part#</b>	<b>Component Description</b>	<b>List Price</b>	<b>OEM Part #</b>
			C3389	\$75.95	EC236060AFM	Outer Clutch Cover	\$12.39	50330027000
					EC441032AFM	Inner Clutch Cover	\$16.13	50330025000
					EC442060AFM	Mag Cover	\$13.52	50330040000
					EC443012F	Clutch Release Gasket	\$2.56	50332065050
					EC443032AFM	Clutch Release Gasket .032"	\$2.56	50332065050
					EC443060AFM	Clutch Release Gasket .060"	\$2.56	50332065050
					EC446020F	Center Case Gasket	\$16.13	50330039000
			<b>Clutch &amp; Mag Kit</b>	<b>List Price</b>	<b>Component Part#</b>	<b>Component Description</b>	<b>List Price</b>	<b>OEM Part #</b>
			C7368CM	\$25.91	EC236060AFM	Outer Clutch Cover	\$12.39	50330027000
					EC442060AFM	Mag Cover	\$13.52	50330040000
			<b>Crank Seal Kit</b>	<b>List Price</b>	<b>Component Part#</b>	<b>Component Part#</b>	<b>List Price</b>	<b>OEM Part#</b>
			C7661	\$28.81	OS136	Right Crank Seal 24X35X7	\$15.99	760253570
					OS141	Left Crank Seal 31X45X6	\$15.99	760324564
200 SX, EXC, MXC	03-14	O-Ring	C7942	\$38.33	R0048	Outer Head O-ring	\$13.94	52330137000
XC-W	03-16				R72X2V	Inner Head O-ring	\$3.57	0770720021
					B0338018AFM	Base Gasket .018"	\$9.32	50330035040
					B0338032AFM	Base Gasket .032"	\$9.32	50330035040
					R44X3S	Expansion Chamber O-rings	\$2.82	0770440030
						2 Req.		
					EC545032AFM	Intermediate Gasket	\$6.02	52337046100
					PV075032AFM	Right Side Power Valve Gasket	\$2.44	50337008000
					PV076032AFM	Left Side Power Valve Gasket	\$2.44	50337006000
					PV077032AFM	Power Valve Cover Gasket	\$2.44	50337035050
					WA131	Power Valve Control Shaft Seal	\$2.31	0603262322
					WA133	Head Crush Washer -6X10X1	\$0.90	0603061001
						3 Req.		
					R8X2V	Power Valve Axle O-ring	\$1.13	0770008020
						2 Req.		
			<b>Bottom End Kit w/crank seals</b>	<b>List Price</b>	<b>Component Part#</b>	<b>Component Description</b>	<b>List Price</b>	<b>OEM Part #</b>
			C3389	\$78.99	EC236060AFM	Outer Clutch Cover	\$12.39	50330027000
					EC441032AFM	Inner Clutch Cover	\$16.13	50330025000
					EC442060AFM	Mag Cover	\$13.52	50330040000
					EC443012F	Clutch Release Gasket	\$2.56	50332065050
					EC443032AFM	Clutch Release Gasket .032"	\$2.56	50332065050
					EC443060AFM	Clutch Release Gasket .060"	\$2.56	50332065050
					EC446020F	Center Case Gasket	\$16.13	50330039000
			<b>Clutch &amp; Mag Kit</b>	<b>List Price</b>	<b>Component Part#</b>	<b>Component Description</b>	<b>List Price</b>	<b>OEM Part #</b>
			C7368CM	\$25.91	EC236060AFM	Outer Clutch Cover	\$12.39	50330027000
					EC442060AFM	Mag Cover	\$13.52	50330040000
			<b>Crank Seal Kit</b>	<b>List Price</b>	<b>Component Part#</b>	<b>Component Part#</b>	<b>List Price</b>	<b>OEM Part#</b>
			C7661	\$28.81	OS136	Right Crank Seal 24X35X7	\$15.99	760253570
					OS141	Left Crank Seal 31X45X6	\$15.99	760324564

All Component Parts can be purchased individually.



**WARNING:** Cancer and Reproductive Harm www.P65Warnings.ca.gov



# MX/Dirt · Off-Road Gaskets



Cometic Gasket - An Exclusive NASCAR Performance® Product

## KTM 250SX

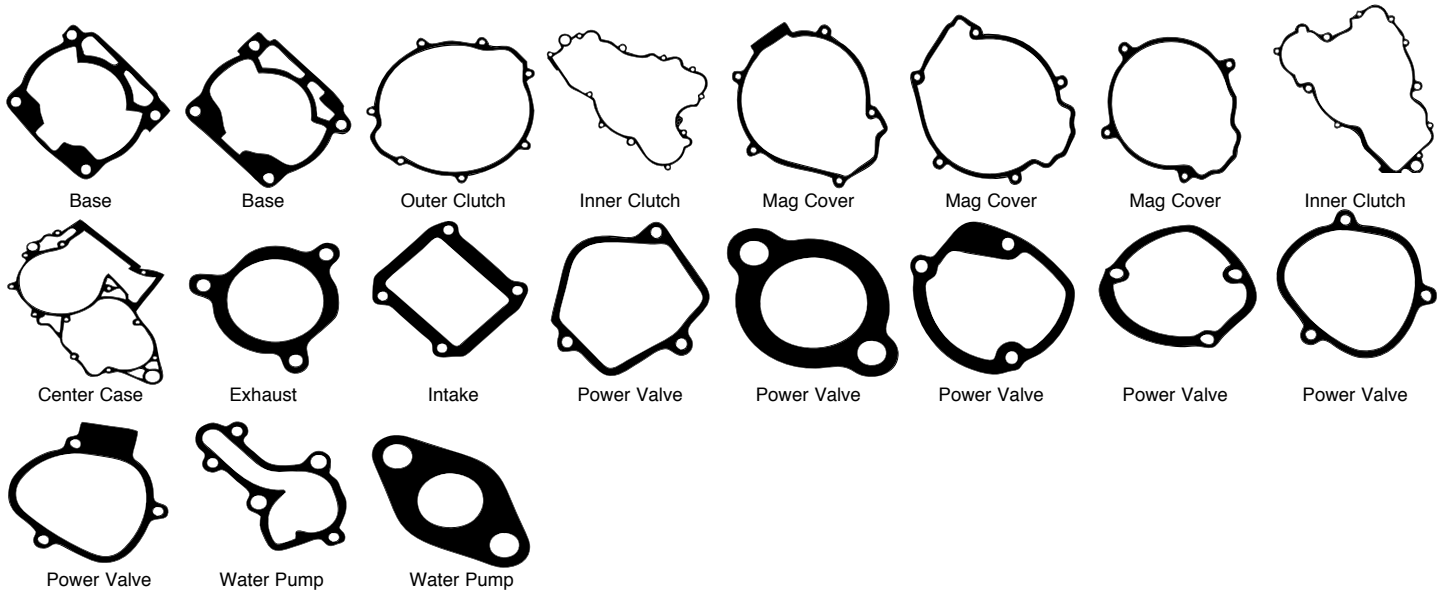

Model	Year	Bore Size	Top End Kit	List Price	Component Part#	Component Description	List Price	OEM Part #				
250 SX, EXC	90-99	O-Ring	C7098	\$38.33	R114X2B	Outer Head O-ring	\$4.00	0770114020				
					R74X2S	Inner Head O-ring	\$3.57	0770740021				
					B0056018AFM	Base Gasket .018"	\$9.32	54630030005				
					B0056032AFM	Base Gasket .032"	\$6.25	54630030107				
					EX014047F	Exhaust Flange Gasket	\$4.65	54630046000				
					PV028018AFM	Power Valve Timer Gasket	\$3.80	54637006100				
					PV049018AFM	Left Side Power Valve Gasket	\$3.80	54637106000				
					PV088032AFM	Right Side Power Valve Gasket	\$2.33	54637073000				
					<b>Bottom End Kit w/crank seals</b>				<b>List Price</b>	<b>Component Part#</b>	<b>List Price</b>	<b>OEM Part#</b>
								C3390	\$80.26	EC234060AFM	Outer Clutch Cover Gasket	\$12.39
					EC285032AFM	Inner Clutch Cover	\$14.87	54630025200				
					EC286020F	Center Case Gasket	\$20.22	54630039200				
					EC287060AFM	Mag Cover Gasket	\$10.68	54630040300				
					R24X2V	Transmission Counter Shaft O-ring	\$6.19	0770250020				
					WP008032AFM	Water Pump Gasket	\$3.80	54635003200				
					WP081032AFM	Power Valve Spring Cover	\$2.33	54435037000				
<b>Crank Seal Kit</b>				<b>List Price</b>	<b>Component Part#</b>	<b>List Price</b>	<b>OEM Part#</b>					
			C7662	\$28.81	OS136	Right Crank Seal 24X35X7	\$15.99	760253570				
					OS137	Left Crank Seal 37X53X7	\$15.99	760385273				
250 SX 250 EXC	00-02 00-03	O-Ring	C7690	\$42.13	R114X2B	Outer Head O-ring	\$4.00	0770114020				
					R74X2S	Inner Head O-ring	\$3.57	0770720021				
					B0056018AFM	Base Gasket .018"	\$9.32	54630030005				
					B0056032AFM	Base Gasket .032"	\$6.25	54630030107				
					R44X3S	Expansion Chamber O-ring	\$2.82	0770440030				
					EX014042AM	Exhaust Flange Gasket	\$4.65	54630046000				
					PV103032AFM	Left Side Power Valve Gasket	\$3.80	54737006000				
					PV104032AFM	Right Side Power Valve Gasket	\$3.80	54737008000				
					<b>Bottom End Kit w/crank seals</b>				<b>List Price</b>	<b>Component Part#</b>	<b>List Price</b>	<b>OEM Part#</b>
								C3391	\$75.99	EC234060AFM	Outer Clutch Cover Gasket	\$12.39
					EC285032AFM	Inner Clutch Cover	\$14.87	54630025200				
					EC286020F	Case Gasket	\$20.22	54630039200				
					EC549060AFM	Mag Cover Gasket	\$11.75	54730040100				
					WP008032AFM	Water Pump Gasket	\$3.80	54635003200				
<b>Crank Seal Kit</b>				<b>List Price</b>	<b>Component Part#</b>	<b>List Price</b>	<b>OEM Part#</b>					
			C7662	\$28.81	OS136	Right Crank Seal 24X35X7	\$15.99	760253570				
					OS137	Left Crank Seal 37X53X7	\$15.99	760385273				
<b>Clutch &amp; Mag Kit</b>				<b>List Price</b>	<b>Component Part#</b>	<b>List Price</b>	<b>OEM Part #</b>					
			C7690CM	\$24.14	EC234060AFM	Clutch Cover Gasket	\$12.39	54630025050				
					EC549060AFM	Mag Cover Gasket	\$11.75	54730040100				

All Component Parts can be purchased individually.

**WARNING:** Cancer and Reproductive Harm www.P65Warnings.ca.gov



# MX/Dirt • Off-Road Gaskets



Cometic Gasket - An Exclusive NASCAR Performance® Product

## KTM 250SX

Model	Year	Bore Size	Top End Kit	List Price	Component Part#	Component Description	List Price	OEM Part #
250 SX	03-06	O-Ring	C7943	\$45.99	R114X2B	Outer Head O-ring	\$4.00	0770114020
					R74X2S	Inner Head O-ring	\$3.57	0770720021
					B0666018AFM	Base Gasket .018"	\$6.25	54830030004
					B0666032AFM	Base Gasket .032"	\$6.25	54830030004
					IR386018AFM	Intake Gasket	\$4.37	548030062000
					R44X3S	Exp. Chamber O-rings 2 Req.	\$2.82	0770440030
					PV103032AFM	Left Side Power Valve Gasket	\$3.80	54737006000
					PV104032AFM	Right Side Power Valve Gasket	\$3.80	54737008000

Bottom End Kit	List Price	Component Part#	Component Description	List Price	OEM Part#
C7943BE	\$95.99	WA133	Clutch Slave Cyl. Crush Washer	\$0.90	0603100141
		R30X1.5V	Clutch slave Cylinder O-ring	\$2.29	0770300015
		R19X3V	Fill Plug O-ring	\$3.02	0770191015
		WA133	Water Pump Crush Washer	\$0.90	0603100141
		R0050	Water Pump Gasket	\$11.30	54835003000
		WA137	Drain Plug Crush Washer	\$1.53	58038022000
		WA133	Water PC Crush Washer	\$0.90	0603061001
		R25X1.5V	Crank Backup O-ring	\$6.19	0770250015
		EC778032AFM	Primary Cover Gasket (Inner Clutch)	\$14.90	54830024100
		EC779020F	Center Case Gasket	\$9.50	54830039000
		IR386018AFM	Intake Reed Gasket	\$4.37	54830062200
		R25X2V	Output Shaft Backup O-ring	\$3.21	0770250020
		R24X2V	Exhaust Valve Control O-ring	\$6.19	0770240020
		R114V	Spring Guide O-ring	\$1.10	0770021120

Oil Seal Kit	List Price	Component Part#	Component Description	List Price	OEM #
C7943OS	\$44.40	OS136	Left Crank Seal 25x35x7	\$15.99	760253570
		OS137	Right Crank Seal 38x52x7	\$15.99	760385273
		OS197	Shift Shaft Seal 14x24x6	\$2.46	760142460
		OS202	Water Pump Shaft Seal 8x24x7	\$7.56	760082472
		OS310	Start Shaft Seal 19x30x7	\$4.29	760193070
		OS390	Output Shaft Seal 32x45x7	\$3.05	760324571

Clutch & Mag Kit	List Price	Component Part#	Component Description	List Price	OEM #
C7943CM	\$27.47	EC777032AFM	Mag Cover Gasket	\$11.75	
		R0049	Clutch Cover O-ring	\$15.70	55130027000

**All Component Parts can be purchased individually.**



**WARNING:** Cancer and Reproductive Harm [www.P65Warnings.ca.gov](http://www.P65Warnings.ca.gov)



# MX/Dirt · Off-Road Gaskets



Cometic Gasket - An Exclusive NASCAR Performance® Product

## KTM 250SX

Model	Year	Bore Size	Top End Kit	List Price	Component Part#	Component Description	List Price	OEM Part #
250 EXC	04-06	O-Ring	C7417	\$46.33	R74X2S	Inner Head O-ring 2004	\$3.57	0770740021
250 XC					R76X2V	Inner Head O-ring 2005	\$3.64	0770760021
					WA135	Head Seal Crush Washer 6 Req.	\$0.80	56530080000
					R114X2B	Outer Head O-ring	\$4.00	0770114020
					B0666018AFM	Base Gasket .018"	\$6.25	54830030004
					B0666032AFM	Base Gasket .032"	\$6.25	54830030004
					IR386018AFM	Intake Gasket	\$4.37	548030062000
					R44X3S	Expansion Chamber O-rings 2 Req.	\$2.82	0770440030
					R15X1.5V	Power Valve Control O-ring	\$1.13	077015051
					R11.5X2.5V	Power Valve Cover O-rings 4 Req.	\$0.94	0770116241
					PV103032AFM	Left Side Power Valve Gasket	\$3.80	54737006000
					PV104032AFM	Right Side Power Valve Gasket	\$3.80	54737008000

Bottom End Kit	List Price	Component Part#	Component Part#	List Price	OEM Part#
C7417BE	\$94.99	EC778032AFM	Primary Cover Gasket	\$14.87	54830024000
		EC779020F	Center Case Gasket	\$23.80	54830039000
		EC1927018AFM	Electric Starter Cover Gasket	\$6.74	55130041100
		R25X3V	Electric Starter O-ring 25x3	\$2.21	0770250030
		IR683018AFM	Intake Reed Gasket	\$4.37	
		R25X1.5V	Crank Seal Backup O-ring 25x1.5	\$6.19	0770250015
		R19X3V	Fill Plug O-ring 19x3	\$3.02	0770191015
		R0050	Water Pump Cover Gasket	\$11.30	54835003000
		WA129	Water Pump Drain Crush Washer 10x14x1	\$0.95	0603100141
		WA133	Clutch Cover Water Passage Crush Washer 6x10x1	\$0.90	0603061001
		WA137	Clutch Cover Drain Plug 12x18x1.5	\$1.53	58038022000
		R117B	Breather Element O-ring 18,72X2,62	\$0.42	0770021160
		R30X1.5V	Slave Cylinder O-ring 30x1.5	\$2.29	0770300015
		R25X2V	Output Shaft Backup O-ring 25x2	\$3.21	0770250020
		R24X2V	Power Valve Actuator Cap O-ring 24x2	\$6.19	0770240020
		R49X2.5V	Water Pump Support O-ring 49x2.5	\$3.14	0770049025
		R114V	Power Valve Spring Guide O-ring 12,37X2,62	\$1.10	0770021120
<b>Oil Seal Kit</b>	<b>List Price</b>	<b>Component Part#</b>	<b>Component Description</b>	<b>List Price</b>	<b>OEM #</b>
C7417OS	\$49.50	OS217	Left Crankcase Seal 25x35x7	\$15.59	0760253570
		OS137	Right Crankcase Seal 38x52x7	\$15.99	0760385273
		OS310	Start Shaft Seal 19x30x7	\$4.29	0760193070
		OS141	Output Shaft Oil Seal 32x45x6.5	\$15.99	0760324565
		OS197	Shift Shaft Seal 14x24x6	\$2.46	0760142460
		OS202	Impeller Seal 8x24x7	\$7.56	0760082472
<b>Clutch &amp; Mag Kit</b>	<b>List Price</b>	<b>Component Part#</b>	<b>Component Description</b>	<b>List Price</b>	<b>OEM #</b>
C7417CM	\$37.26	R0049	Clutch Cover O-ring	\$15.72	54830025000
		EC777032AFM	Mag Cover Gasket	\$11.75	54830040000
		EC1254032AFM	Mag Cover Gasket 07-16	\$9.79	55130040000/ 55130040100

All Component Parts can be purchased individually.



**WARNING:** Cancer and Reproductive Harm www.P65Warnings.ca.gov





# MX/Dirt • Off-Road Gaskets



Cometic Gasket - An Exclusive NASCAR Performance® Product

## KTM 250SX

Model	Year	Bore Size	Top End Kit	List Price	Component Part#	Component Description	List Price	OEM Part #
250 SX	07-16	O-Ring	C3222	\$38.33	R73X2V	Inner Head O-ring 250 Models	\$3.71	0770730020
250 XC	07-16				R78X2V	2008 300 XC Models	\$4.29	0770078020
					WA135	Head Seal O-rings	\$0.80	56530080000
					R105X2B	Outer Head O-ring	\$2.57	0770105020
					B0666018AFM	Base Gasket .018"	\$6.25	54830030004
					R44X3S	Exhaust Flange O-rings	\$2.82	0770440030
					PV136032AFM	Left Side Power Valve Gasket	\$4.72	54837006000
					PV137032AFM	Right Side Power Valve Gasket	\$5.00	54837008000
					R112V	Power Valve Flap O-rings	\$1.19	0770116241
					R114V	Power Valve Spring Guide O-ring	\$1.19	0770021120
					R16X2V	Power Valve Control O-rings 2 Req.	\$3.02	0770160021
					R24X2V	Power Valve Control Cover O-ring	\$6.19	0770240020
			<b>Bottom End Kit</b>	<b>List Price</b>	<b>Component Part#</b>	<b>Component Part#</b>	<b>List Price</b>	<b>OEM Part#</b>
			C3539	\$101.61		Intake Gasket	\$4.09	54830062200
					EC779020F	Center Case Gasket	\$23.80	54830039000
					EC778032AFM	Clutch Cover Gasket	\$14.87	54830024000
					R19X3V	Clutch Fill Plug O-ring 19,00x3,00 NBR	\$3.02	0770191015
					R0049	Outer Clutch Cover O-ring	\$15.72	54830025000
					WA137	Drain Plug Washer 12x18x1,5	\$1.53	58038022000
					R0050	Water Pump Cover O-ring MR	\$11.30	54835003000
					WA129	Water Pump Drain Crush Washer 10x14x1	\$0.95	0603100141
					R25X1.5V	Crank O-ring 25x1.5	\$6.19	0770250015
					WA129	Copper Crush Gasket Clutch Line 2 Req. 10X14X1	\$0.95	0603100141
					R30X1.5V	Slave Cylinder O-Ring	\$2.29	0770300015
					R25X2V	Output Shaft O-ring 25,00X2,00	\$3.21	0770250020
					R027V	Thermostat O-ring 32x2	\$3.57	0770320020
					EC1254032AFM	Ignition Cover Gasket	\$9.79	55130040000
					EC1927018AFM	Outer Ignition Cover (Estart)	\$6.74	55130041100
					R25X3V	Estart O-ring 25,00X3,00	\$2.90	0770250030
			<b>Clutch &amp; Mag Kit</b>	<b>List Price</b>	<b>Component Part#</b>	<b>Component Description</b>	<b>List Price</b>	<b>OEM Part #</b>
			C7943CM	\$27.47	EC234060AFM	Clutch Cover Gasket	\$12.39	54630025050
					EC777032AFM	Mag Cover Gasket	\$11.75	54830040000
			<b>Top End Kit</b>	<b>List Price</b>	<b>Component Part#</b>	<b>Component Description</b>	<b>List Price</b>	<b>OEM Part #</b>
250 SX, XC, 17-18 XC-W		O-Ring	C3623	\$38.33	WA135	Cylinder Head Crush Washer	\$0.80	56530080000
					WA133	Water Jacket Crush Seal	\$0.90	603061001
					R78X2V	Inner Head O-ring 300 Models	\$4.29	770078020
					R73X2V	Inner Head O-ring	\$3.71	770730020
					R105X2B	Outer Head O-ring	\$2.57	770105020
					PV137032AFM	Right Power Valve Cover Gasket	\$5.00	54837008000
					PV136032AFM	Left Power Valve Gasket	\$4.72	54837006000
					R112V	Front Exhaust Cover O-Ring	\$1.19	770116241
					B1384010RC	Cylinder Base Gasket	\$6.25	55430030020
					B1384018AFM	Cylinder Base Gasket	\$6.25	55430030040
					B1384020RC	Cylinder Base Gasket	\$6.25	55430030050
					B1384032AFM	Cylinder Base Gasket	\$6.25	55430030075
					R16X2V	Exhaust Control O-ring	\$3.02	770160021
					R15X1.5V	Exhaust Control Flap O-ring	\$1.13	770150151
					R24X2V	PV Actuator Cover O-ring	\$6.19	770240020
					R12.5X2.5V	PV Guide Spring	\$2.89	770021120
					R44X3V	Exhaust O-rings	\$2.82	770440030
			<b>Oil Seal Kit</b>	<b>List Price</b>	<b>Component Part#</b>	<b>Component Description</b>	<b>List Price</b>	<b>OEM #</b>
			C3623OS	56.00	OS141	Output Shaft Seal	15.99	0760324571
					OS197	Shift Shaft Seal	2.46	0760142460
					OS199	BalancE Shaft Seal	17.45	47030076100
					OS202	Water Pump Shaft Seal	7.56	0760082472
					OS217	Left Crank Seal	14.03	0760253570
					OS264	Right Crank Seal	10.97	0760385273



# MX/Dirt · Off-Road Gaskets



Cometic Gasket - An Exclusive NASCAR Performance® Product

## KTM 250SX

Model	Year	Bore Size	Top End Kit	List Price	Component Part#	Component Description	List Price	OEM Part #
250 EXC, RFS	02-05	76 mm	C7169	\$58.76	H1925040S	Head Gasket	\$25.95	59830036000
			C7409	\$58.76	H2099040S	Head Gasket 78mm Bore	\$25.95	
		78 mm			B0480020F	Base Gasket	\$4.32	59030035050
					EX281042AM	Exhaust Gasket	\$12.44	59036041000
					EC495018AFM	Cam Chain Tensioner	\$3.80	59036003050
					VC027031F	Valve Cover Gasket	\$1.19	58036053000
					R017B	Oil Screen Plug O-rings	\$1.14	0770020170
					R12.5X2V	Oil Screen O-rings 2 Req.	\$3.74	0770125015
					R40X2.5B	Oil Filter O-rings 2 Req.	\$3.74	0770400025
					WA005063C	Oil Line Washers 4 Req.	\$0.57	0603082121
					WP114018AFM	Water Pump Gasket	\$1.71	59035053000
250 SX-F, EXC-F, XC-F	05-12	77 mm	C3164-EST	\$60.84	H2408027S	Head Gasket 77mm Bore	\$33.23	77030036000
		78 mm	C3184-EST	\$60.84	H2408SP5027S	Head Gasket 79mm Bore	\$33.23	77030036000
					B0748010RC	Base Gasket	\$9.94	77030035000
					EX702064AM	Exhaust Gasket	\$8.68	77036041000
					R018B	Cam Chain Tensioner O-ring	\$3.92	0770180020
					WA145	Cam Chain Tensioner Seal	\$2.16	0603242920
					WA146	Cam Chain Guide Bolt Seal	\$2.16	0603082121
					3186V	Valve Seals 4 Req.	\$4.99 ea.	77036027000
					R012SB	Plug Seal O-Ring	\$0.96	0770080020
			<b>Bottom End Kit w/o crank seals</b>	<b>List Price</b>	<b>Component Part#</b>	<b>Description</b>	<b>List Price</b>	<b>OEM Part#</b>
			C3502	\$47.35	EC1035032AFM	Mag Cover Gasket	\$6.30	77030040000
					R40X2.5B	Oil filter O-Ring	\$3.74	0770400025
					R12.5X2V	Oil Screen O-rings 2 Req.	\$3.74	0770125015
					R017B	Oil Screen Plug O-ring	\$1.14	0770020170
					WP427	Water Pump Cover Gasket	\$6.19	77035053000
					WA133	Water Pump Crush Seal	\$0.90	0603061001
					R30X1.5V	Slave Cylinder O-Ring	\$2.29	0770300015
					EC1360018AFM	Slave Cylinder Gasket	\$4.37	59032065000
					WA129	Clutch Bleeder Seal	\$0.95	42013226000
					EC1036032AFM	Inner Clutch Cover Gasket	\$17.38	77030025100
					WA137	Oil Drain Plug Seal 2 Req.	\$1.53	58038022000
					R12X2V	Oil Relief O-Ring	\$4.09	0770120020
250 SX-F, EXC-F, XC-F	13-19	78mm	C3511-EST	\$71.75	R023V	Plug Well O-ring 2 Req.	\$1.46	0770260015
			C3516-EST	\$71.75	R9X1.5V	Cam End Plug O-ring 2 Req.	\$2.56	07700900151
					H3698SP2027S	81mm Cylinder Head Gasket	\$33.23	77730036085
					WA145	Cam Chain Tensioner Gasket	\$2.16	0603242920
					R018B	Cam Chain O-Ring	\$3.92	0770180020
					R013V	Cam Chain O-Ring	\$1.08	0770010010
					3186V	Valve Seal 4 Req.	\$4.99 ea.	77036027000
					B1026010RC	Base Gasket	\$11.87	77230035000
					R10X2V	Temp Sensor O-ring	\$1.59	0770100020
					EX1333059F	Exhaust Gasket	\$5.05	77236041000
					H3698027S	Stock Cylinder Head Gasket	\$33.23	77730036085
					R40X2V	Intake Cam Decompr. O-Ring	\$2.82	0770400010
			<b>Bottom End Kit</b>	<b>List Price</b>	<b>Component Part#</b>	<b>Component Description</b>	<b>List Price</b>	<b>OEM Part#</b>
			C3513	\$52.59	EC1455032AFM	Mag Cover Gasket	\$6.30	77530040000
					WA137	Magnet Plug Crush Washer	\$1.53	58038022000
					R022V	Output Shaft O-Ring	\$1.19	0770020220
					WA129	Clutch Line Crush Washers	\$0.95	42013226000
					EC1742018AFM	Starter Cover Gasket	\$1.71	77240043000
					R014V	Drain Plug Gasket	\$1.08	0770110015
					R014V	Drain Plug O-Ring 2 Req.	\$1.08	0770110015
					R19X3V	Fill plug O-Ring	\$3.02	0770191015
					R12.5X2V	Oil Screen O-Rings 2 Req.	\$3.74	0770125015
					R031V	Oil Pump Cover O-Ring	\$4.65	0770440020
					R028V	Oil Filter O-Ring	\$1.19	07703305178
					R017V	Oil Screen Plug O-Ring	\$0.50	0770020170
					EC1817018AFM	Clutch Slave Cylinder Gasket	\$4.37	77232062000
					WP427	Water Pump Cover Gasket	\$4.29	77235053000
					EC1816032AFM	Inner Clutch Cover Gasket	\$17.38	77730025000
					MR126	Outer Clutch Cover O-ring	\$8.04	77230027000

All Component Parts can be purchased individually.



**WARNING:** Cancer and Reproductive Harm www.P65Warnings.ca.gov



# MX/Dirt • Off-Road Gaskets



Cometic Gasket - An Exclusive NASCAR Performance® Product

## KTM 250 SX-F

Model	Year	Bore Size	Top End Kit	List Price	Component Part#	Component Description	List Price	OEM Part #
250 SX-F,	15-19	79mm	C3595-EST	\$71.75	H3698027S	Cylinder Head Gasket	\$33.23	79030036086
Factory Edition					B1301014RC	Cylinder Base Gasket	\$17.59	79230035000
					3186V	Valve Stem Seals 4 Required	\$4.99	77036027000
					R018B	Cam Chain Tensioner O-ring	\$3.92	770180020
					WA145Cam Chain Tensioner	Crush Seal	\$2.16	603242920
					R013V	Cam Chain Tensioner Cap O-ring	\$1.08	770010010
					R023V	Plug Well Cam Tower O-rings	\$1.46	770260015
					EX1333059F	Exhaust Flange Gasket	\$5.05	77236041000

Bottom End Kit w/Oil Seals	List Price	Component Part#	Component Description	List Price	OEM Part #
C3595BE	\$97.36	WA133	Clutch Cover Crush Seal	\$0.90	0603061001
		WA133	Water Pump Crush Washer	\$0.90	0603061001
		WA135	Clutch Banjo Bolt Crush Washer	\$0.80	0603080161
		R017B	Oil Screen Cover O-ring	\$1.14	0770020170
		R022V	Output Shaft O-ring	\$1.19	0770020220
		R3.5X2B	Oil Squirter O-ring	\$0.38	0770035020
		R014V	Drain Plug O-ring	\$1.08	0770110015
		R19X3V	Fill Plug O-ring	\$3.02	0770191015
		R25X3V	Starter O-ring	\$2.90	0770250030
		R30X1.5V	Slave Cylinder O-Ring	\$2.29	0770300015
		R031V	Oil Pump Cover O-ring	\$4.65	0770440020
		R119B	Crank End O-ring	\$1.04	07700240251
		R9X1.5V	Balance Shaft O-rings	\$2.56	07700900151
		R12.5X2V	Oil Screen O-ring	\$3.74	07701250151
		R028V	Oil Filter Cover O-ring	\$1.19	07703305178
		WA123	Right Case Locating Screw	\$1.96	58030081000
			Crush Washer		
		WA137	Magnetic Plug Crush Washer	\$1.53	58038022000
		WA137	Oil Check Valve Crush Washer	\$1.53	58038022000
		EC2178032AFM	Inner Clutch Cover	\$15.59	79230025000
		EC2181032AFM	Slave Cylinder Gasket	\$4.37	79232065000
		WP504	Water Pump Gasket	\$7.19	79235053000

Oil Seal Kit	List Price	Component Part#	Component Description	List Price	OEM Part #
C3595OS	\$36.69	OS269	Oil Pump Seal	\$1.48	0760142450
		OS197	Shift Shaft Seal	\$2.46	0760142460
		OS391	Mag Seal	\$10.73	0760304760
		OS390	Output Shaft Seal	\$3.05	0760324571
		OS392	Primary Side Oil Seal	\$12.99	0760405561
		OS393	Balance Shaft Seal/Water Pump Seals	\$5.03	07601530451

Clutch & Mag Kit	List Price	Component Part#	Component Description	List Price	OEM Part #
C3595CM	\$20.98	R0079	Outer Clutch Cover	\$8.99	79230027000
		EC2177032AFM	Mag Cover Gasket	\$11.99	79230040000



# MX/Dirt · Off-Road Gaskets



Cometic Gasket - An Exclusive NASCAR Performance® Product

## KTM 300SX

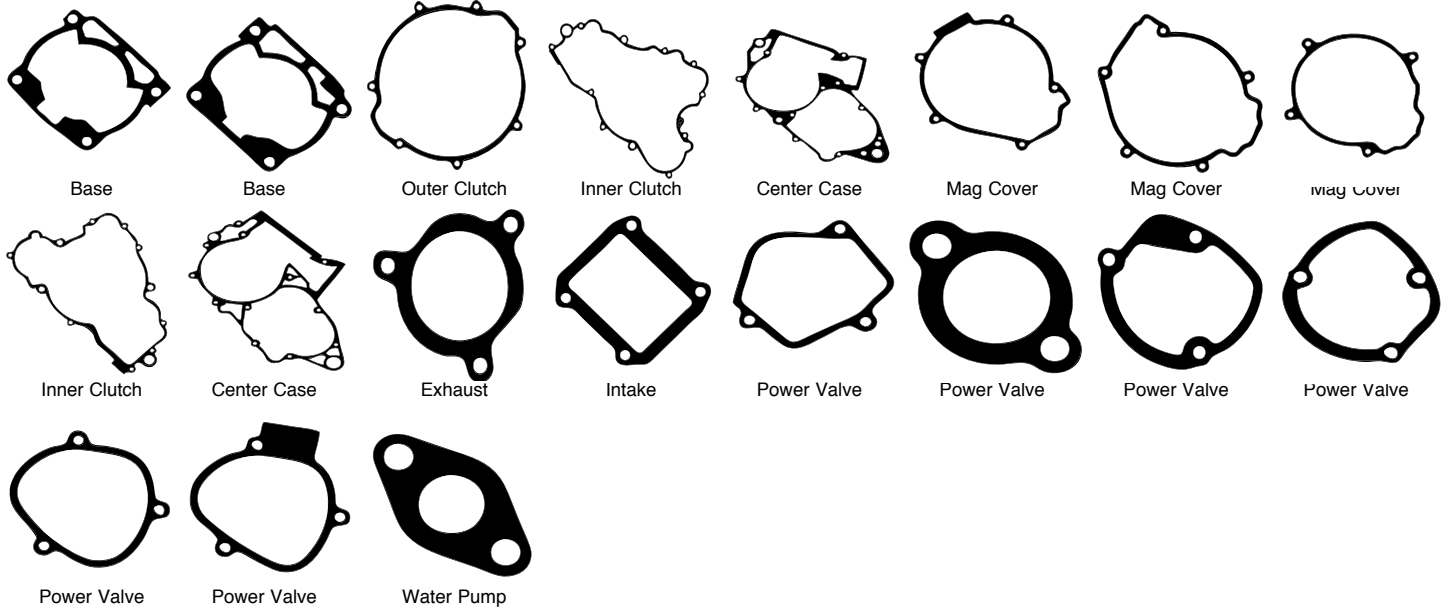

Model	Year	Bore Size	Top End Kit	List Price	Component Part#	Component Description	List Price	OEM Part #			
300 SX, EXC	90-99	O-Ring	C7099	\$38.33	R78X2V	Inner Head O-ring 300 XC Models	\$4.29	0770078020			
					R114X2B	Outer Head O-ring	\$4.00	0770114020			
					B0056018AFM	Base Gasket .018"	\$9.32	54630030005			
					B0056032AFM	Base Gasket .032"	\$6.25	54630030107			
					EX014047F	Exhaust Flange Gasket	\$4.65	54630046000			
					PV028018AFM	Right Side Power Valve	\$3.80	54637006100			
					PV049018AFM	Left Side Power Valve	\$3.80	54637106000			
					PV088032AFM	Rt. Side Power Valve 90-99	\$2.33	54637073000			
						<b>Bottom End Kit w/crank seals</b>	<b>List Price</b>	<b>Component Part#</b>	<b>Component Part#</b>	<b>List Price</b>	<b>OEM Part#</b>
						C3390	\$80.26	WP081032AFM	Power Valve Spring Cover	\$2.33	54435037000
								EC234060AFM	Outer Clutch Cover Gasket	\$12.39	54630025050
								EC285032AFM	Inner Clutch Cover Gasket	\$14.87	54630025200
								EC286020F	Center Case Gasket	\$20.22	54630039200
								EC287060AFM	Mag Cover Gasket	\$10.68	54630040300
			R24X2V	Water Pump O-ring	\$6.19	0770240020					
				<b>Component Part#</b>	<b>List Price</b>	<b>OEM Part#</b>					
			OS136	Right Crank Seal 24X35X7	\$15.99	760253570					
			OS137	Left Crank Seal 37X53X7	\$15.99	760385273					
300 SX, EXC, MXC	00-03	O-Ring	C7816	\$38.33	R78X2V	Inner Head O-ring 300 XC Models	\$4.29	0770078020			
					R114X2B	Outer Head O-ring	\$4.00	0770114020			
					B0056018AFM	Base Gasket .018"	\$9.32	54630030005			
					B0056032AFM	Base Gasket .032"	\$6.25	54630030107			
					EX014047F	Exhaust Flange Gasket	\$4.65	54630046000			
					R15X1.5V	Power Valve Control O-rings 2 Req.	\$1.13	0770 15051			
					R16X2V	Power Valve Control O-rings 2 Req.	\$3.02	0770160021			
					PV103032AFM	Left Side Power Valve Gasket	\$3.80	54737006000			
					PV104032AFM	Right Side Power Valve Gasket	\$3.80	54737008000			
						<b>Bottom End Kit w/crank seals</b>	<b>List Price</b>	<b>Component Part#</b>	<b>Component Part#</b>	<b>List Price</b>	<b>OEM Part#</b>
						C3391	\$75.99	EC234060AFM	Outer Clutch Cover Gasket	\$12.39	54630025050
								EC285032AFM	Inner Clutch Cover Gasket	\$14.87	54630025200
								EC286020F	Center Case Gasket	\$20.22	54630039200
								EC549060AFM	Mag Cover Gasket	\$11.75	54730040100
			WP081032AFM	Power Valve Spring Cover	\$2.33	54435037000					
				<b>Component Description</b>	<b>List Price</b>	<b>OEM Part #</b>					
			EC234060AFM	Clutch Cover Gasket	\$12.39	54630025050					
			EC549060AFM	Mag Cover Gasket	\$11.75	54730040100					
				<b>Component Part#</b>	<b>List Price</b>	<b>OEM Part#</b>					
			OS136	Right Crank Seal 24X35X7	\$15.99	760253570					
			OS137	Left Crank Seal 37X53X7	\$15.99	760385273					

All Component Parts can be purchased individually.

**WARNING:** Cancer and Reproductive Harm www.P65Warnings.ca.gov



# MX/Dirt • Off-Road Gaskets



Cometic Gasket - An Exclusive NASCAR Performance® Product

## KTM 300EXC

Model	Year	Bore Size	Top End Kit	List Price	Component Part#	Component Description	List Price	OEM Part #					
300 EXC, MXC, XC, XC-W	04-07	O-Ring	C7423	\$46.33	R80X2S	Inner Head O-ring	\$5.29	0770800021					
					R114X2B	Outer Head O-ring	\$4.00	0770114020					
					WA135	Head Seal Crush Washer 6 Req.	\$0.80	56530080000					
					B0666018AFM	Base Gasket .018"	\$6.25	54830030004					
					B0666032AFM	Base Gasket .032"	\$6.01	54830030004					
					IR386018AFM	Intake Gasket	\$4.37	548030062000					
					R44X3S	Exp. Chamber O-rings 2 Req.	\$2.82	0770440030					
					PV103032AFM	Left Side Power Valve Gasket	\$3.80	54737006000					
					PV104032AFM	Right Side Power Valve Gasket	\$3.80	54737008000					
					R11.5X2.5V	Power Valve Cover O-rings 4 Req.	\$0.94	0770116241					
					R15X1.5V	Power Valve Control O-ring	\$1.13	077015051					
					04-16			Bottom End Kit C7417BE	\$94.99	EC778032AFM	Primary Cover Gasket	\$14.87	54830024000
										EC779020F	Center Case Gasket	\$23.8	54830039000
										EC1927018AFM	Electric Starter Cover Gasket	\$6.74	55130041100
										R25X3V	Electric Starter O-ring 25x3	\$2.21	0770250030
										IR683018AFM	Intake Reed Gasket	\$4.37	
										R25X1.5V	Crank Seal Backup O-ring 25x1.5	\$6.19	0770250015
										R19X3V	Fill Plug O-ring 19x3	\$3.02	0770191015
										R0050	Water Pump Cover Gasket	\$11.30	54835003000
										WA129	Water Pump Drain Crush Washer 10x14x1	\$0.95	0603100141
										WA133	Clutch Cover Water Passage Crush Washer 6x10x1	\$0.90	0603061001
										WA137	Clutch Cover Drain Plug 12x18x1.5	\$1.53	58038022000
										R117B	Breather Element O-ring 18,72X2,62	\$0.42	0770021160
R30X1.5V	Slave Cylinder O-ring 30x1.5	\$2.29	0770300015										
R25X2V	Output Shaft Backup O-ring 25x2	\$3.21	0770250020										
R24X2V	Power Valve Actuator Cap O-ring 24x2	\$6.19	0770240020										
R49X2.5V	Water Pump Support O-ring 49x2.5	\$3.14	0770049025										
R114V	Power Valve Spring Guide O-ring 12,37X2,62	\$1.10	0770021120										
Oil Seal Kit C7417OS				\$49.50						OS217	Left Crankcase Seal 25x35x7	\$15.59	0760253570
										OS137	Right Crankcase Seal 38x52x7	\$15.99	0760385273
										OS310	Start Shaft Seal 19x30x7	\$4.29	0760193070
										OS141	Output Shaft Oil Seal 32x45x6.5	\$15.99	0760324565
										OS197	Shift Shaft Seal 14x24x6	\$2.46	0760142460
										OS202	Impeller Seal 8x24x7	\$7.56	0760082472
					R0049	Clutch Cover O-ring	\$15.72	54830025000					
					Clutch & Mag Kit C7417CM				\$37.26	EC777032AFM	Mag Cover Gasket	\$11.75	54830040000
EC1254032AFM	Mag Cover Gasket 2007-2016	\$9.79	55130040000/ 55130040100										
300 XC, XC-W	08-17	O-Ring	C3222	\$38.33	R73X2V	Inner Head O-ring 250 Models	\$3.71	0770730020					
					R78X2V	2008 300 XC Models	\$4.29	0770078020					
					R105X2B	Outer Head O-ring	\$2.57	0770105020					
					WA135	Head Seal O-rings	\$0.80	56530080000					
					B0666018AFM	Base Gasket .018"	\$6.25	54830030004					
					R44X3S	Exhaust Flange O-rings	\$2.82	0770440030					
					PV136032AFM	Left Side Power Valve Gasket	\$4.72	54837006000					
					PV137032AFM	Right Side Power Valve Gasket	\$5.00	54837008000					
					R112V	Power Valve Flap O-rings	\$1.19	0770116241					
					R114V	Power Valve Spring Guide O-ring	\$1.19	0770021120					
					R16X2V	Power Valve Control O-rings 2 Req.	\$3.02	0770160021					
					R24X2V	Power Valve Control Cover O-ring	\$6.19	0770240020					
					Clutch & Mag Kit C7943CM				\$27.47	EC234060AFM	Clutch Cover Gasket	\$12.39	54630025050
										EC777032AFM	Mag Cover Gasket	\$11.75	54830040000

All Component Parts can be purchased individually.



**WARNING:** Cancer and Reproductive Harm [www.P65Warnings.ca.gov](http://www.P65Warnings.ca.gov)





# MX/Dirt • Off-Road Gaskets



Cometic Gasket - An Exclusive NASCAR Performance® Product

## KTM 350SX-F

Model	Year	Bore Size	Top End Kit	List Price	Component Part#	Component Description	List Price	OEM Part #			
350SX-F	11-12	88mm	C3428-EST	\$60.84	H3093SP4027S	88mm Cylinder Head Gasket	\$33.23	77230036000			
			C3429-EST	\$60.84	H3093027S	90mm Cylinder Head Gasket	\$33.23				
			C3458-EST	\$60.84	H3093SP1027S	91mm Cylinder Head Gasket	\$33.23				
						R10X2V	Water Temp Sensor O-ring	\$1.59	0770100020		
						R18X2.5V	Cam Chain Tensioner O-ring	\$1.71	0770180020		
						R9X2V	Head Seal O-rings	\$1.59	0770090015		
						WA145	Cam Chain Tensioner Seal	\$2.16	0603242920		
						B1026014RC	Base Gasket	\$11.87	77230035000		
						3231V	Valve Seals 4 Req.	\$6.48 ea.	77236027000		
						R013V	Cam Chain Wear Bushing O-ring	\$1.08	0770010010		
					R023V	Plug Shaft O-rings	\$1.46	0770260015			
350SX-F, XC-F	13-14	88mm	C3519-EST	\$60.84	3231V	Valve Seals 4 Req.	\$6.48 ea.	77236027000			
			C3520-EST	\$60.84	R013V	Cam Chain Wear Bushing O-ring	\$1.08	0770010010			
			C3521-EST	\$60.84	R023V	Plug Shaft O-rings	\$1.46	0770260015			
							R10X2V	Water Temp Sensor O-ring	\$1.59	0770100020	
							R018B	Cam Chain Tensioner O-ring	\$1.71	0770180020	
							R9X2V	Head Seal O-rings	\$1.59	0770090015	
							WA145	Cam Chain Tensioner Seal	\$2.16	0603242920	
							H3093SP4032S	88mm Cylinder Head Gasket	\$33.23	77230036000	
							H3093032S	90mm Cylinder Head Gasket	\$33.23		
							H3093SP1032S	91mm Cylinder Head Gasket	\$33.23		
							B1026014RC	Base Gasket	\$11.87	77230035000	
							EX1333059F	Exhaust Gasket	\$5.05	77236041000	
		350 SX-F, Factory Edition	15-19	88mm	C3605-EST	\$60.84	H3093SP4032S	Cylinder Head Gasket	\$33.23	79230036086	
								B1301014RC	Cylinder Base Gasket	\$11.87	79230035000
								3231V	Valve Stem Seals 4 Required	\$6.48	77236027000
								R018B	Cam Chain Tensioner O-ring	\$1.71	0770180020
								WA145	Cam Chain Tensioner Crush Seal	\$2.16	0603242920
								R013B	Cam Chain Tensioner Cap O-ring	\$1.19	0770010010
								R023V	Plug Well Cam Tower O-ring	\$1.46	0770260015
								R23X1.5V	Plug Shaft Insert O-ring 23x1.5	\$2.95	7702300151
								R9X1.5V	Oil Galley O-rings 9x1.5	\$2.56	07700900151
								EX1333059F	Exhaust Flange Gasket	\$5.05	77236041000
						<b>Bottom End Kit w/Oil Seals</b>	<b>List Price</b>	<b>Component Part#</b>	<b>Component Description</b>	<b>List Price</b>	<b>OEM Part #</b>
						C3595BE	\$97.36	WA133	Water Pump Crush Washer	\$0.90	0603061001
								WA135	Clutch Banjo Bolt Crush Washer	\$0.80	0603080161
								R017B	Oil Screen Cover O-ring	\$1.14	0770020170
								R022V	Output Shaft O-ring	\$1.19	0770020220
								R3.5X2B	Oil Squirter O-ring	\$0.38	0770035020
								R014V	Drain Plug O-ring	\$1.08	0770110015
								R19X3V	Fill Plug O-ring	\$3.02	0770191015
								R25X3V	Starter O-ring	\$2.90	0770250030
								R30X1.5V	Slave Cylinder O-Ring	\$2.29	0770300015
								R031V	Oil Pump Cover O-ring	\$4.65	0770440020
								R119B	Crank End O-ring	\$1.04	07700240251
								R9X1.5V	Balance Shaft O-rings	\$2.56	07700900151
								R12.5X2V	Oil Screen O-ring	\$3.74	07701250151
								R028V	Oil Filter Cover O-ring	\$1.19	07703305178
								WA123	Right Case Locating Screw	\$1.96	58030081000
									Crush Washer		
					WA137	Magnetic Plug Crush Washer	\$1.53	58038022000			
					WA137	Oil Check Valve Crush Washer	\$1.53	58038022000			
					EC2178032AFM	Inner Clutch Cover	\$15.59	79230025000			
					EC2181032AFM	Slave Cylinder Gasket	\$4.37	79232065000			
					WP504	Water Pump Gasket	\$7.19	79235053000			
			<b>Oil Seal Kit</b>	<b>List Price</b>	<b>Component Part#</b>	<b>Component Description</b>	<b>List Price</b>	<b>OEM Part #</b>			
			C3595OS	\$36.69	OS269	Oil Pump Seal	\$1.48	0760142450			
					OS197	Shift Shaft Seal	\$2.46	0760142460			
					OS391	Mag Seal	\$10.73	0760304760			
					OS390	Output Shaft Seal	\$3.05	0760324571			
					OS392	Primary Side Oil Seal	\$12.99	0760405561			
					OS393	Balance Shaft Seal/Water Pump Seals	\$5.03	07601530451			
			<b>Clutch &amp; Mag Kit</b>	<b>List Price</b>	<b>Component Part#</b>	<b>Component Description</b>	<b>List Price</b>	<b>OEM Part #</b>			
			C3595CM	\$20.98	R0079	Outer Clutch Cover	\$8.99	79230027000			
					EC2177032AFM	Mag Cover Gasket	\$11.99	79230040000			



# MX/Dirt · Off-Road Gaskets



Cometic Gasket - An Exclusive NASCAR Performance® Product

## KTM 350EXC

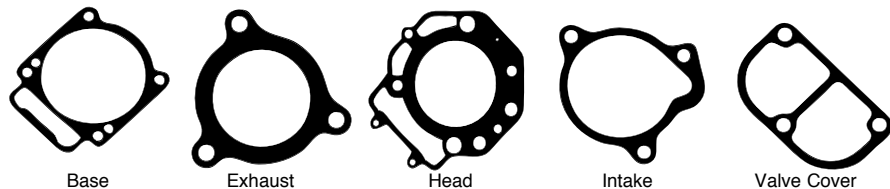

Model	Year	Bore Size	Top End Kit	List Price	Component Part#	Component Description	List Price	OEM Part #
350 EXC, RXC	87-90	O-Ring	C7288	\$49.80	H0378040A	Head Gasket	\$22.32	57530036000
					B0230020RC	Base Gasket	\$8.75	58030030000
					IR056032AFM	Intake Gasket	\$6.25	58136043000
					EX088031F	Exhaust Gasket 2 Req.	\$6.25	58036041000
					VC027032AFM	Valve Cover Gasket 2 Req.	\$4.72	58036053000

## KTM 360/380 SX, EXC

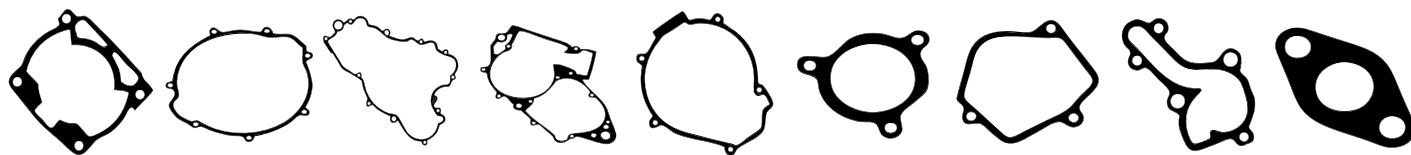

Model	Year	Bore Size	Top End Kit	List Price	Component Part#	Component Description	List Price	OEM Part #
360 SX, EXC	96-97	O-Ring	C7285	\$38.33	R114X2B	Outer Head O-ring	\$4.00	0770114020
380 SX, EXC	98-01				R84X2V	Inner Head O-ring	\$4.22	077084021
					B0056018AFM	Base Gasket .018"	\$9.32	54630030005
					B0056032AFM	Base Gasket .032"	\$6.25	54630030107
					PV028018AFM	Right Side Power Valve Gasket	\$3.80	54637006100
					PV049018AFM	Left Side Power Valve Gasket	\$3.80	54637106000
					EX014047F	Exhaust Flange Gasket	\$4.65	54630046000
			<b>Bottom End Kit w/crank seals</b>	<b>List Price</b>	<b>Component Part#</b>	<b>Component Part#</b>	<b>List Price</b>	<b>OEM Part#</b>
			C3390	\$80.26	EC234060AFM	Outer Clutch Cover Gasket	\$12.39	54630025050
					EC285032AFM	Inner Clutch Cover Gasket	\$14.87	54630025200
					EC286020F	Center Case Gasket	\$20.22	54630039200
					EC287060AFM	Mag Cover Gasket	\$10.68	54630040300
					WP008032AFM	Water Pump Gasket	\$3.80	54635003200
					WP081032AFM	Power Valve Spring Cover	\$2.33	54435037000
			<b>Crank Seal Kit</b>	<b>List Price</b>	<b>Component Part#</b>	<b>Component Part#</b>	<b>List Price</b>	<b>OEM Part#</b>
			C7662	\$28.81	OS136	Right Crank Seal 24X35X7	\$15.99	760253570
					OS137	Left Crank Seal 37X53X7	\$15.99	760385273

## KTM 400LC4

Model	Year	Bore Size	Top End Kit	List Price	Component Part#	Component Description	List Price	OEM Part #
400 LC4, MLS Head	88-01	95.5 mm	C7170	\$61.95	H1955040S	95.5mm Head Gasket	\$54.57	58030136200
					B0230020RC	Base Gasket	\$8.75	58030030000



# MX/Dirt • Off-Road Gaskets



Cometic Gasket - An Exclusive NASCAR Performance® Product

## KTM 400

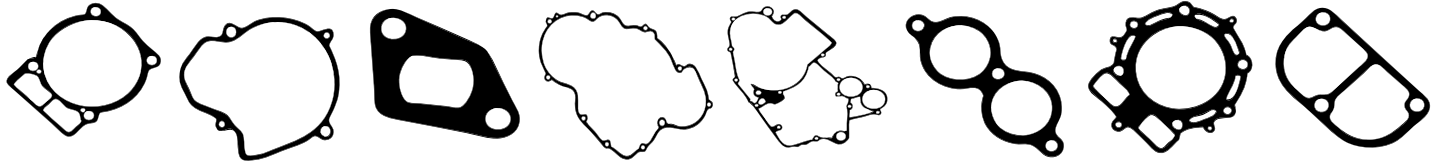

Model	Year	Bore Size	EST	List Price	Component Part#	Component Description	List Price	OEM Part #
400, 450, 525 SX, EXC, RFS	00-06	91 mm	C7693-EST	\$71.71	H1017040S	Head Gasket 91mm Bore	\$41.55	59030036000
		94 mm	C7885-EST	\$71.71	H1843040S	Head Gasket 94mm Bore	\$41.55	
		95 mm	C7944-EST	\$71.71	H1521040S	Head Gasket 95mm Bore	\$41.55	
		96 mm	C7454-EST	\$71.71	H2081040S	Head Gasket 96mm Bore	\$41.55	
		97 mm	C7691-EST	\$71.71	H1018040S	Head Gasket 97mm Bore	\$41.55	
		98 mm	C7461-EST	\$71.71	H1018SP4040S	Head Gasket 98mm Bore	\$41.55	
		99 mm	C7792-EST	\$71.71	H1018SP2040S	Head Gasket 99mm Bore	\$41.55	
					B0480020F	Base Gasket	\$4.32	59030035050
					EX281042AM	Exhaust Gasket	\$12.44	59036041000
					EC495018AFM	Timing Cover Gasket	\$3.80	59036003050
					3225V	Valve Seals 4 Req.	\$1.76 ea.	59036027000
					VC027031F	2 Req. Valve Cover Gasket	\$1.19	58036053000
					R017B	Oil Screen Plug O-rings	\$1.14	0770020170
					R12.5X2V	Oil Screen O-rings 2 Req.	\$3.74	
					R40X2.5B	Oil Filter O-rings 2 Req.	\$3.74	0770400025
					WA005063C	Oil Line Washers 4 Req.	\$0.57	0603082121
			<b>Bottom End Kit w/o crank seals</b>	<b>List Price</b>	<b>Component Part#</b>	<b>Component Description</b>	<b>List Price</b>	<b>OEM Part#</b>
			C3394	\$43.63	WP114018AFM	Water Pump Gasket	\$1.71	59035053000
					EC496032AFM	Clutch Cover Gasket	\$17.38	59030025000
					EC494032AFM	Mag Cover Gasket	\$17.38	59030040000
					EC497012F	Center Case Gasket	\$17.38	59030039000
			<b>Clutch &amp; Mag Kit</b>	<b>List Price</b>	<b>Component Part#</b>	<b>Component Description</b>	<b>List Price</b>	<b>OEM Part #</b>
			C7693CM	\$34.76	EC496032AFM	Clutch Cover Gasket	\$17.38	59030025000
					EC494032AFM	Mag Cover Gasket	\$17.38	59030040000

## KTM 450SX-F

Model	Year	Bore Size	EST	List Price	Component Part#	Component Description	List Price	OEM Part #
450SX-F	07-12	97mm	C3412-EST	\$57.69	H2623027S	Head Gasket 97mm Bore	\$29.11	77330036000
450 Rally	14				R010V	Oil Jet O-rings	\$0.40	0770060015
					R9X1.5V	Head Oil Plug O-ring	\$2.56	0770090015
					EX873059F	Exhaust Gasket	\$5.05	77336041000
					R014V	Head Coolant Plug Gasket	\$1.08	0770090015
					R25X2V	Cam Tower Plug Well O-ring	\$3.21	0770025020
					3225V	Valve Stem Seals	\$1.76 ea.	59036027000
					R013B	Cam Chain Tensioner O-ring	\$1.19	0770010010
					WA145	Cam Chain Tens. Crush Seal	\$2.16	0603242920
					R18X2.5V	Cam Chain Tens. Piston O-ring	\$1.71	0770180020
					R014V	Cam Chain Bushing O-ring	\$1.08	0770012015
					R017B	Cam Axle O-ring	\$1.14	0770015018
					R046V	Base O-ring	\$1.19	0770108018
					B0928	Cam Galley Base O-ring	\$4.75	77330035000
505SX-F	07-10	100mm	C3413-EST	\$57.69	H2623SP1027S	Head Gasket 100mm Bore	\$29.11	77330036000
					R010V	Oil Jet O-rings	\$0.40	0770060015
					R9X1.5V	Head Oil Plug O-ring	\$2.56	0770090015
					EX873059F	Exhaust Gasket	\$5.05	77336041000
					R014V	Head Coolant Plug Gasket	\$1.08	0770090015
					R25X2V	Cam Tower Plug Well O-ring	\$3.21	0770025020
					3225V	Valve Stem Seals	\$1.76 ea.	59036027000
					R013B	Cam Chain Tens. O-ring	\$1.19	0770010010
					WA145	Cam Chain Tens. Crush Seal	\$2.16	0603242920
					R18X2.5V	Cam Chain Tens. Piston O-ring	\$1.71	0770180020
					R014V	Cam Chain Bushing O-ring	\$1.08	0770012015
					R017B	Cam Axle O-ring	\$1.14	0770015018
					R046V	Base O-ring	\$1.19	0770108018
					B0928	Cam Galley Base O-ring	\$4.75	77330035000



**WARNING:** Cancer and Reproductive Harm www.P65Warnings.ca.gov



# MX/Dirt • Off-Road Gaskets



Cometic Gasket - An Exclusive NASCAR Performance® Product

## KTM 450EXC-R

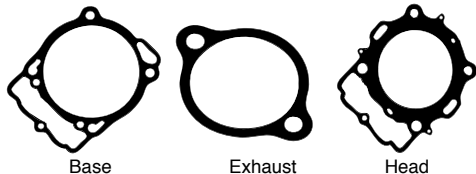

Model	Year	Bore Size	EST Top End Kit	List Price	Component Part#	Component Description	List Price	OEM Part #
450 EXC-R	08	95 mm	C3241-EST	\$61.31	H2759045S	Head Gasket 95mm Bore	\$41.55	78030036000
530 EXC-R		97 mm	C3242-EST	\$61.31	H2759SP3045S	Head Gasket 97mm Bore	\$41.55	
450 SX-F	12	99 mm	C3243-EST	\$61.31	H2759SP1045S	Head Gasket 99mm Bore	\$41.55	
Factory Replica		101 mm	C3244-EST	\$61.31	H2759SP4045S	Head Gasket 101mm Bore	\$41.55	
450 SX-F	13-15				B0933014RC	Base Gasket	\$9.94	78030035000
					EX873059F	Exhaust Gasket	\$5.05	77336041000
					R019V	Cam Chain Tensioner O-ring	\$0.57	0770180020
					WA145	Cam Chain Tensioner Seal	\$2.16	603242920
					3225V	Intake Valve Seals 4 Req.	\$1.76 ea.	59036027000
					3186V	Exhaust Valve Seals 2 Req.	\$4.99 ea.	77036027000
					R014V	Rocker Arm O-ring	\$1.08	0770110015
					R10X2V	Temp Sensor O-ring	\$1.59	0770100020
450SX-F	16	99mm	C3604-EST	\$61.31	R10X2V	Temp. Sensor O-ring	\$1.59	0770100020
Factory Edition					R017B	Oil Filter Screen O-ring 17x1.78	\$1.14	0770020170
EX-C450F	17-19				R15X1.5V	Rocker Arm O-rings 15.00X1.50	\$1.13	0770150151
					R031V	Oil Pump Cover O-ring	\$4.65	0770440020
					3225V	Valve Seal	\$1.63	59036027000
					R9950	EX-C Exhaust Valve Seal Pack	\$10.92	77036027000
					EC495018AFM	Cam Chain Tensioner Gasket	\$3.80	59036003050
					EX1589059F	Exhaust Gasket	\$8.68	78036041000
					H4207036S	Cylinder Head Gasket	\$46.33	79430036010
					B1323014RC	Cylinder Base Gasket	\$9.94	79430035000
500 EXC	12-16	95mm	C3697	\$74.07	3186V	Exhaust Valve Seal (2)	\$4.99	77036027000
					3225V	Intake Valve Seal	\$1.63	59036027000
					B0933014RC	Cylinder Base Gasket	\$9.94	78030035000
					EC495018AFM	Cam Chain Tensioner Gasket	\$3.80	59036003050
					EX1589059F	Header Gasket	\$8.68	78036041000
					H2759040S	Cylinder Head Gasket 95mm 1mm Thick	\$41.55	78930036010
					R014V	Rocker Arm O-ring 11x1.5	\$1.08	770110015
					R10X2V	Water Temp Sensor O-ring 10x2	\$1.59	770100020
					WA133	Head Crush Washer 6x10x1	\$0.90	603061001
					WA137	Head Crush Washer 12x18x5	\$1.53	58038022000
620 LC	88-01	102 mm	C7171	\$61.95	H1956040S	Head Gasket 102mm Bore	\$54.57	58330036000
		105 mm	C7209	\$61.95	H1957040S	Head Gasket 105mm Bore	\$54.57	
					B0230020RC	Base Gasket	\$8.75	58030030000

## LEM

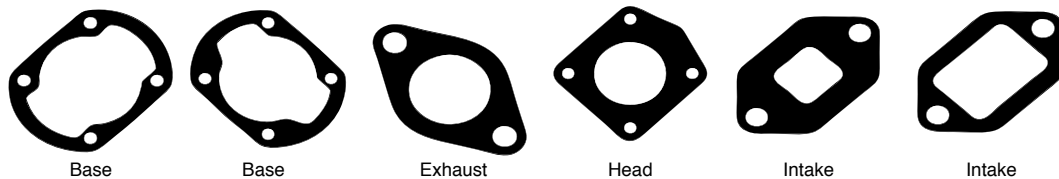

Model	Year	Bore Size	Top End Kit	List Price	Component Part#	Component Description	List Price	OEM Part #
Cross	96-03	41 mm	C7282	\$31.91	H0354010C	Head Gasket .010" Copper	\$9.37	36330036000
CR-3 USA					H0354020C	Head Gasket .020" Copper	\$9.37	36330036000
LX1, LX2 Factory					B0219018AFM	Base Gasket 00-01	\$4.65	45030035800
LX2, LX2 Sport					B0220018AFM	Base Gasket 94-99	\$4.65	36330030000
LX3					IR054018AFM	Intake Port Small Opening	\$3.80	49130438000
LX3 Sport					IR055018AFM	Intake Port Large Opening	\$3.80	49130438000
					EX089039F	Exhaust Gasket	\$4.77	45030046000

All Component Parts can be purchased individually.



**WARNING:** Cancer and Reproductive Harm [www.P65Warnings.ca.gov](http://www.P65Warnings.ca.gov)



# MX/Dirt • Off-Road Gaskets



Cometic Gasket - An Exclusive NASCAR Performance® Product

## SUZUKI JR50

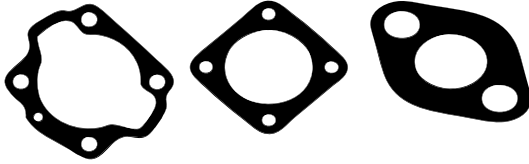

Model	Year	Base Bore Size	Head Bore Size	Intake	List Price
JR50	78-08	43 mm		C7014	\$15.19

Component Part#	Component Description	List Price	OEM Part #
H1281020RC	Head Gasket	\$6.25	11141-04000
B0543020RC	Base Gasket	\$6.02	11241-04010
IR417020F	Intake Gasket	\$1.71	13121-04000-H17
EX349042AM	Exhaust Gasket	\$3.58	14181-04200

## SUZUKI RM60

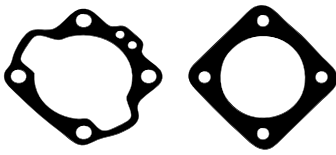

Model	Year	Base Bore Size	Head Bore Size	Top End Kit	List Price
RM60	03-04	45 mm		C7501	\$22.99

Component Part#	Component Description	List Price	OEM Part #
H0262043F	Head Gasket	\$17.38	11004-1218
B0371018AFM	Base Gasket	\$6.19	11060-1873
B0371012	High Comp. Base Gasket .012"	\$6.19	11060-1873

Bottom End Kit w/Oil Seals	List Price	Component Part#	Component Description	List Price #	OEM Part #
C7154BE	\$49.00	R9X2V	Clutch Pushrod O-ring	\$1.59	670B1509
		WA107	Drain Plug Seal	\$2.74	92065-058
		WP0500032AFM	Water Elbow Outlet	\$2.44	11009-1952
		R222V	Water Pump Body O-ring	\$3.92	670B3039
		WA107	Trans Fluid Drain Plug	\$2.74	92065-058
		R013B	Output Shaft O-ring	\$1.19	92055-022
Oil Seal Kit	List Price	Component Part#	Component Description	List Price #	OEM Part #
C7736OS	\$40.64	OS331	Shift Shaft Seal 13x22x5.5	\$3.71	92051-005
		OS131	Output Shaft Seal 25x37x6	\$7.10	92050-013
Crank Seal Kit	List Price	Component Part#	Component Description	List Price	OEM Part #
C7656	\$16.99	OS110	Crank Seal 20x40x7	\$9.47	92049-1188
		OS366	Start Shaft Seal 16x24x4	\$4.25	92049-002
		OS368	Water Pump Shaft Seal 8x18x10	\$8.75	92049-1366
Clutch & Mag Kit	List Price	Component Part#	Component Description	List Price #	OEM Part #
C7736CM	\$17.38	EC275032AFM	Clutch Cover Gasket	\$8.69	11009-1976

## SUZUKI RM65

Model	Year	Base Bore Size	Head Bore Size	Top End Kit	List Price
RM65	03-08	45 mm		C7736	\$22.99
		47 mm		C7682	\$22.99
		48 mm		C7737	\$22.99

Component Part#	Component Description	List Price	OEM Part#
H0970010S	Head Gasket 45mm Bore	\$18.56	11004-1346
H0971010S	Head Gasket 47mm Bore	\$18.56	
H0972010S	Head Gasket 48mm Bore	\$18.56	
B0444018AFM	Base Gasket	\$6.19	11060-1921
B0444012F	High Comp. Base Gasket .012"	\$6.19	
R218V	Exhaust O-rings 2 Req.	\$1.19	11060-1925

Bottom End Kit w/Oil Seals	List Price	Component Part#	Component Description	List Price #	OEM Part #
C7736BE	\$47.57	WP104020F	Water Pump Gasket	\$2.16	K1106-01924
		WP105020F	Water Outlet Gasket	\$2.16	K1106-01927
		WA118	Water Pump Drain Crush Washer	\$1.88	KK920-22077
		R013B	Output Shaft O-rings	\$1.19	KK920-55022
		WA108	Drain Plug Gasket	\$2.56	KK920-65058
Oil Seal Kit	List Price	Component Part#	Component Description	List Price #	OEM Part #
C7736OS	\$40.64	OS360	Water Pump Seal Outer	\$5.31	K9204-91359
		OS368	Water Pump Seal Inner	\$8.48	K9204-91366
		OS365	Clutch Actuator Seal	\$2.50	K9204-91414
		OS366	Kickstart Seal	\$4.07	KK920-49002
		OS131	Output Shaft Seal	\$7.10	KK920-50013
		OS331	Shift Shaft Seal	\$3.71	KK920-51005
Clutch & Mag Kit	List Price	Component Part#	Component Description	List Price #	OEM Part #
C7736CM	\$17.38	EC275032AFM	Clutch Cover Gasket	\$8.69	11009-1976
		EC2740032AFM	Mag Cover Gasket	\$8.69	11009-1974



**WARNING:** Cancer and Reproductive Harm www.P65Warnings.ca.gov





# MX/Dirt · Off-Road Gaskets



Cometic Gasket - An Exclusive NASCAR Performance® Product

## SUZUKI RM80

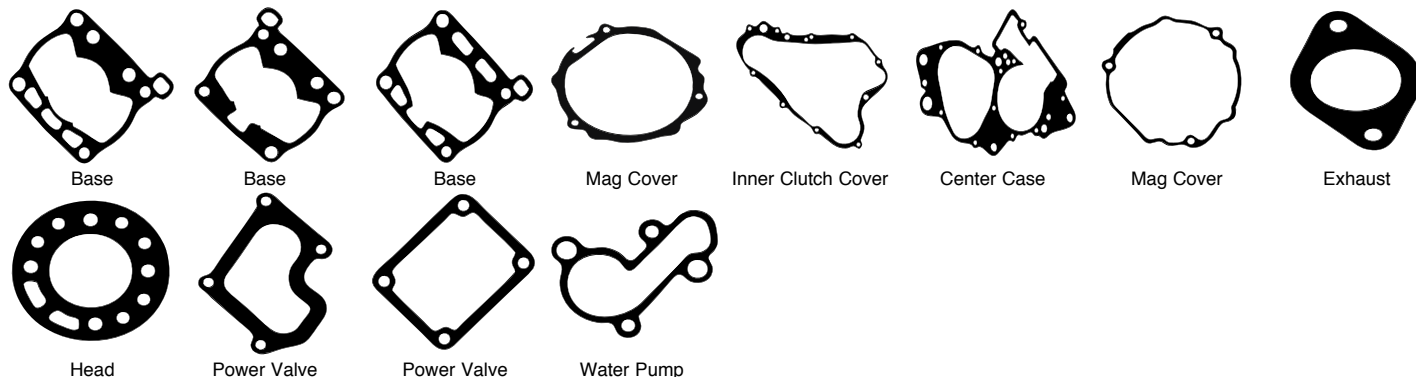

Model	Year	Bore Size	Top End Kit	List Price	Component Part#	Component Description	List Price	OEM Part #
RM80	83-85	51 mm	C7102	\$17.57	H0038043F	Head Gasket 51mm	\$15.47	11141-20931-H17
					B0037020F	Base Gasket	\$4.65	11241-20900-H17
RM80 G, H, J	86-88	50 mm	C7052	\$21.76	H0039043F	Head Gasket	\$14.87	1141-02B60
					B0038020F	Base Gasket	\$4.65	11241-03B01
					IR009020F	Intake Gasket	\$3.80	13156-02B00
					EX010042AM	Exhaust Gasket	\$4.65	14181-02B00
			Crank Seal Kit C7699	\$12.77	OS171	31X44X8 Right Crank Seal	\$9.47	09289-32003
					OS172	17X30X8 Left Crank Seal	\$4.72	09283-18004
RM80 K	89-90	50 mm	C7053	\$22.99	H0039043F	Head Gasket	\$14.87	1141-02B60
					B0039020F	Base Gasket	\$4.65	11241-03B01
					IR009020F	Intake Gasket	\$3.80	13156-02B00
					EX010042AM	Exhaust Gasket	\$4.65	14181-02B00
					PV015018AFM	Right Side Power Valve Gasket	\$3.80	11233-02B41
					PV016018AFM	Front Power Valve Cover Gasket	\$3.80	11238-01B30-H17
					R127V	Expansion Chamber O-ring	\$3.92	14171-02B40
			Crank Seal Kit C7663	\$20.29	OS132	29X40X7 Right Crank Seal	\$16.64	09283-30061
					OS174	17X30X6 Left Crank Seal	\$5.91	9283-18006
					C7486	Clutch Cover Gasket	\$10.22	11482-27C00
RM80	91-01	O-Ring	C7054	\$22.99	R55X2V	Inner Head O-ring	\$2.34	11147-03B00
					R87X2B	Outer Head O-ring	\$11.87	11148-03B00
					B0040018AFM	Base Gasket	\$9.32	11241-03B00
					B0040012F	High Compression Base Gasket	\$4.65	11241-03B00
					EX010042AM	Exhaust Gasket	\$4.65	14181-02B00
					PV015018AFM	Right Side Power Valve Gasket	\$3.80	11233-02B41
					PV016018AFM	Front Power Valve Cover Gasket	\$3.80	11238-01B30-H17
					R127V	Expansion Chamber O-ring	\$3.92	14171-02B40
			Bottom End Kit w/crank seals C3357	\$46.75	EC204060AFM	Mag Cover Gasket	\$8.29	11483-02B50
					C7486	Inner Clutch Cover Gasket	\$10.22	11482-27C00
					EC206020F	Crankcase Gasket	\$11.18	11481-02B40
					WP040018AFM	Water Pump Cover Gasket	\$5.00	17431-02B41
			Crank Seal Kit C7663	\$20.29	OS132	29X40X7 Right Crank Seal	\$16.64	09283-30061
					OS174	17X30X6 Left Crank Seal	\$5.91	9283-18006

All Component Parts can be purchased individually.



**WARNING:** Cancer and Reproductive Harm [www.P65Warnings.ca.gov](http://www.P65Warnings.ca.gov)



# MX/Dirt • Off-Road Gaskets



Cometic Gasket - An Exclusive NASCAR Performance® Product

## SUZUKI RM85

Model	Year	Bore Size	Top End Kit	List Price	Component Part#	Component Description	List Price	OEM Part #			
RM85	02-12 18-19	O-Ring	C7857	\$25.55	R57X2V	inner Head O-ring	\$3.20	11147-03B00			
					R88X2B	Outer Head O-ring	\$1.36	11148-03B00			
					B0577018AFM	Base Gasket	\$4.65	11241-03B01			
					B0577012F	High Compression .012"	\$4.65				
						Base Gasket					
					R127V	Expansion Chamber O-ring	\$3.92	14171-02B40			
					PV015018AFM	Right Side Power Valve Cover	\$3.80	11233-02B41			
					PV016018AFM	Front Power Valve Cover Gasket	\$3.80	11238-01B30-H17			
					R015B	Oil Filler Cap O-ring	\$1.08	NA			
						Component Description	List Price	OEM Part #			
						Bottom End Kit	List Price	Component Part#	Component Description	List Price	OEM Part #
						C7857BE	\$76.10	EC654020F	Center Case Gasket	\$11.64	11481-03B00
								WA116	Drain Plug Crush Washer	\$1.06	09168-08016
									8.2x14x1		
								WP040018AFM	Water Pump Cover Gasket	\$5.00	17431-02B42
			WA118	Water Pump Crush Washer	\$1.88	17413-28C10					
			WA124	Primary Cover Water Passage	\$2.22	09168-06004					
				Crush Washer 6.2x11x1.2							
				Component Description	List Price #	OEM Part #					
				Oil Seal Kit	List Price	Component Part#	Component Description	List Price #	OEM Part #		
				C7857OS	38.99	OS244	Clutch Actuator Shaft Seal	\$1.43	09285-10004		
							10x17x5				
						OS364	Water Pump Shaft Seal	\$5.89	17461-03B00		
						OS132	Right Crank Seal 30x40x7	\$16.64	09283-30061		
						OS174	Left Crank Seal 18x30x7	\$5.91	09283-18007		
						OS305	Shift Shaft Seal	\$5.77	09283-14006		
						OS197	Starter Seal 14x24x6	\$2.46	09285-14001		
						OS442	Output Shaft Seal 20x35x5	\$4.2	09283-20057		
							Component Description	List Price	OEM Part #		
							Clutch & Mag Kit	List Price	Component Part#		
							C7857CM	\$26.35	EC653063N		
									C7486		
									Mag Cover Gasket		
									Primary Cover Gasket		
									10.22		
									11483-03B00		
									11482-27C02		
									Component Description		
									List Price		
									OEM Part #		
									Head Gasket 53mm Bore		
									\$20.99		
									11004-1214		
									Head Gasket 54.5mm Bore		
									\$20.99		
									11060-1779		
									Base Gasket		
									\$4.65		
									11060-1779		
									High Compression Base Gasket		
									\$6.25		
									NA		
									Expansion Chamber O-ring		
									\$1.19		
									NA		
									Rt. Side Power Valve Cover		
									\$3.80		
									11060-1778		
									Component Part#		
									List Price		
									OEM Part#		
									Clutch Cover Gasket		
									\$8.69		
									11009-1971		
									Mag Cover Gasket		
									\$8.69		
									11009-1973		
									Water Pump Gasket		
									\$3.74		
									11009-1972		
									Component Description		
									List Price		
									OEM Part #		
									Clutch Cover Gasket		
									\$8.69		
									11009-1971		
									Mag Cover Gasket		
									\$8.69		
									11009-1973		
									Component Part#		
									List Price		
									OEM Part #		
									EST		
									List Price		
									Component Part#		
									Component Description		
									List Price		
									OEM Part #		
									Top End Kit		
									List Price		
									Component Part#		
									Component Description		
									List Price		
									OEM Part #		
									Head Gasket 55mm		
									\$18.56		
									11100-41338		
									Head Gasket 57mm		
									\$18.56		
									Base Gasket		
									\$9.94		
									11106-01796		
									Intake Gasket		
									\$2.33		
									11106-01753		
									Intake O-rings 2 Req.		
									\$1.13		
									11106-01753		
									Exhaust Gasket		
									\$3.35		
									11106-11112		
									Cam Chain Tensioner Bolt O-ring		
									\$1.13		
									11106-11112		
									Cam Chain Tensioner O-ring		
									\$0.42		
									11106-11112		
									Valve Seals		
									\$5.50		
									11106-11112		
									Cam Cover O-ring		
									\$7.36		
									11106-11112		
									Tappet Cover O-rings 2 Req.		
									\$4.65		
									11106-11112		
									Component Description		
									List Price		
									OEM Part #		
									Clutch Cover Gasket		
									\$5.63		
									11061-0131		
									Component Description		
									List Price		
									OEM Part #		
									Head Gasket		
									\$18.56		
									11004-S004		
									Head Gasket 61mm Bore		
									\$18.56		
									11061-S035		
									Base Gasket		
									\$6.25		
									11061-S035		
									Cam Chain Tensioner Gasket		
									\$3.07		
									11061-S038		
									Cam Chain Bolt O-ring		
									\$0.62		
									09280-06005		
									Tappet Plug O-ring 2 Req.		
									\$3.74		
									09280-30001		

All Component Parts can be purchased individually.

**WARNING:** Cancer and Reproductive Harm www.P65Warnings.ca.gov



Cometic Gasket - An Exclusive NASCAR Performance® Product

## SUZUKI RM125

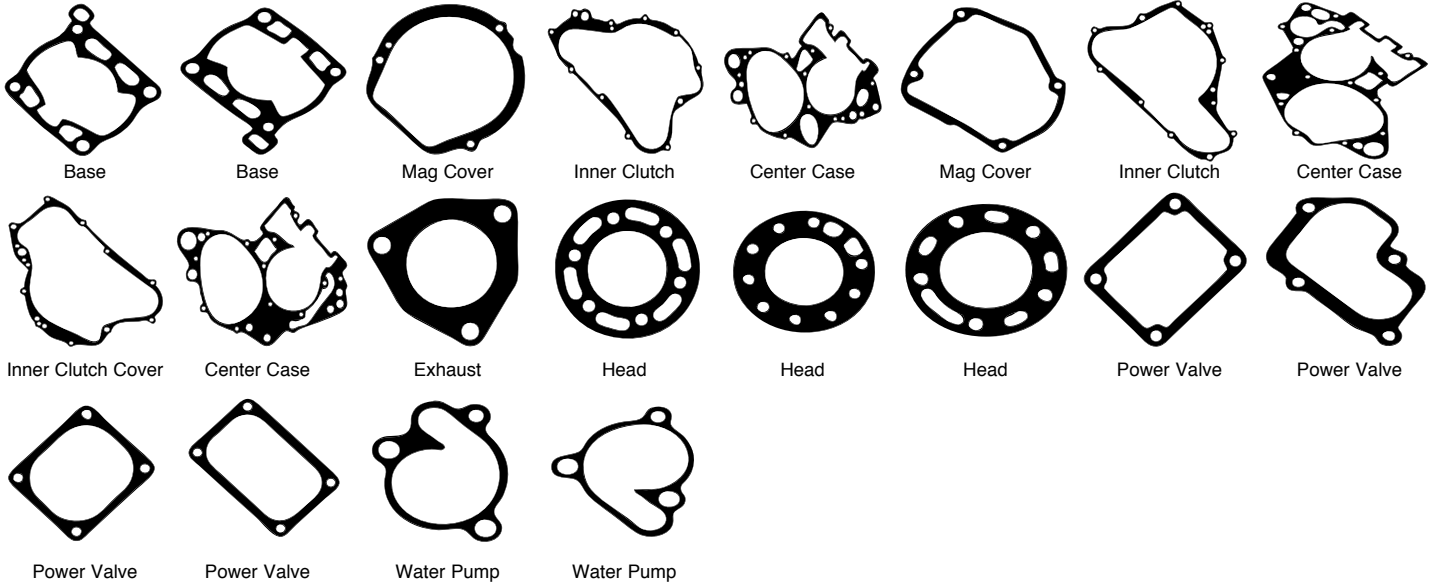

Model	Year	Bore Size	Top End Kit	List Price	Component Part#	Component Description	List Price	OEM Part #
RM125	83	56 mm	C7103	\$20.44	H0040043F B0041020F	Head Gasket Base Gasket	\$17.38 \$5.34	1141-14120-H17 11241-14110-H17
RM125	84-85	56 mm	C7055	\$26.80	B0042020F EX011042AM H0041043F IR010020F	Base Gasket Exhaust Gasket Head Gasket Intake Gasket	\$5.34 \$4.65 \$17.38 \$3.80	11241-14501-H17 14181-40200 11141-14500-H17 13156-14500-H17
RM125	86	56 mm	C7056	\$31.91	B0043020F EX011042AM H0042043F IR010020F PV017020F	Base Gasket Exhaust Gasket Head Gasket Intake Gasket Power Valve Gasket	\$5.34 \$4.65 \$17.38 \$3.80 \$3.80	11241-01B00-H17 14181-40200 11141-01B01-H17 13156-14500-H17 11233-01B00
			Crank Seal Kit C7700	List Price \$12.77	Component Part# OS173 OS174	Component Part# 27X40X8 Right Crank Seal 17X30X6 Left Crank Seal	List Price \$8.29 \$5.91	OEM Part# 9289-28007 9283-18006
RM125	87-88	56 mm	C7057	\$31.91	B0044020F H0043043F IR003018AFM PV016018AFM PV018020F R224V	Base Gasket Head Gasket Intake Gasket Front Power Valve Gasket Right Power Valve Gasket Power Valve O-ring	\$5.34 \$17.38 \$3.80 \$3.80 \$3.80 \$1.19	11241-01B00-H17 11141-01B01-H17 14132-K56-701 11238-01B30-H17 11233-01B30 09280-28005
			Crank Seal Kit C7700	List Price \$12.77	Component Part# OS173 OS174	Component Part# 27X40X8 Right Crank Seal 17X30X6 Left Crank Seal	List Price \$8.29 \$5.91	OEM Part# 9289-28007 9283-18006
RM125	89	56 mm	C7058	\$31.91	H0044043F B0045018AFM PV016018AFM PV019020F R224V	Head Gasket Base Gasket Front Power Valve Gasket Right Power Valve Gasket Power Valve O-ring	\$17.38 \$9.32 \$3.80 \$3.80 \$1.19	11141-27C00 11241-27C10 11238-01B30-H17 11233-27C10 09280-28005
			Crank Seal Kit C7664	List Price \$20.29	Component Part# OS132 OS174	Component Part# 29X40X7 Right Crank Seal 17X30X6 Left Crank Seal	List Price \$16.64 \$5.91	OEM Part# 09283-30061 9283-18006
RM125	90	O-Ring	C7120	\$31.91	R62X2V R89X2B B0045018AFM PV016018AFM PV019020F R224V	Inner Head O-ring Outer Head O-ring Base Gasket Front Power Valve Gasket Right Power Valve Gasket Power Valve O-ring	\$4.64 \$2.86 \$9.32 \$3.80 \$3.80 \$1.19	11147-27C10 11148-27C10 11241-27C10 11238-01B30-H17 11233-27C10 09280-28005

All Component Parts can be purchased individually.



**WARNING:** Cancer and Reproductive Harm [www.P65Warnings.ca.gov](http://www.P65Warnings.ca.gov)



# MX/Dirt • Off-Road Gaskets



Cometic Gasket - An Exclusive NASCAR Performance® Product

## SUZUKI RM125

Model	Year	Bore Size	Top End Kit	List Price	Component Part#	Component Part#	List Price	OEM Part#
RM125	91	O-Ring	C7059	\$31.91	R62X2V	Inner Head O-ring	\$4.64	11147-27C10
					R89X2B	Outer Head O-ring	\$2.86	11148-27C10
					B0045018AFM	Base Gasket	\$9.32	11241-27C10
					PV020018AFM	Right Side Power Valve Gasket	\$3.80	11233-27C32
					PV021032AFM	Front Power Valve Gasket	\$3.80	11238-27C31
			<b>Crank Seal Kit</b>	<b>List Price</b>	<b>Component Part#</b>	<b>Component Part#</b>	<b>List Price</b>	<b>OEM Part#</b>
			C7664	\$20.29	OS132	29X40X7 Right Crank Seal	\$16.64	09283-30061
					OS174	17X30X6 Left Crank Seal	\$5.91	9283-18006
RM125	92	O-Ring	C7112	31.91	R62X2V	Inner Head O-ring	4.64	11147-27C10
					R89X2B	Outer Head O-ring	2.86	11148-27C10
					B0045018AFM	Base Gasket	9.32	11241-27C10
					PV020018AFM	Right Side Power Valve Gasket	3.80	11233-27C32
					PV021032AFM	Front Power Valve Gasket	3.80	11238-27C31
			<b>Bottom End Kit</b>	<b>List Price</b>	<b>Component Part#</b>	<b>Component Part#</b>	<b>List Price</b>	<b>OEM Part#</b>
			C3360	58.27	EC207060AFM	Mag Cover Gasket	8.29	11483-43D00
					EC208032AFM	Inner Clutch Cover Gasket	9.99	11482-43D01
					EC210020F	Center Case Gasket	13.62	11481-43D00
					C7499	Outer Clutch Cover Gasket	13.99	11484-43D00
					WP041018AFM	Water Pump Gasket	4.37	17431-43D00
			<b>Crank Seal Kit</b>	<b>List Price</b>	<b>Component Part#</b>	<b>Component Description</b>	<b>List Price</b>	<b>OEM Part#</b>
			C7664	20.29	OS132	29X40X7 Right Crank Seal	16.64	09283-30061
					OS174	17X30X6 Left Crank Seal	5.91	9283-18006
RM125	93-97	O-Ring	C7136	\$31.91	R62X2V	Inner Head O-ring	\$4.64	11147-27C11
					R89X2B	Outer Head O-ring	\$2.86	11148-27C11
					B0045018AFM	Base Gasket	\$9.32	11241-27C10
					B0045012F	High Comp. Base Gasket .012"	\$9.32	
					PV020018AFM	Right Side Power Valve Gasket	\$3.80	11233-27C32
					PV021032AFM	Front Power Valve Gasket	\$3.80	11238-27C31
					PV061018AFM	Front Power Valve Gasket 97-Up	\$3.80	11238-36E00
			<b>Bottom End Kit</b>	<b>List Price</b>	<b>Component Part#</b>	<b>Component Part#</b>	<b>List Price</b>	<b>OEM Part#</b>
			C7112BE	\$80.53	EC208032AFM	Inner Clutch Cover Gasket	\$9.99	11482-43D01
					EC210020F	Center Case Gasket	\$13.62	11481-43D00
					WP041018AFM	Water Pump Gasket	\$4.37	17431-43D00
					WA125	Drain Plug Gasket	\$2.23	09168-12002
					WA124	Clutch Drain Plug Gasket	\$2.22	09168-06004
					WA118	Water Pump Drain Washer	\$1.88	17413-28C10
			<b>Oil Seal Kit</b>	<b>List Price</b>	<b>Component Part#</b>	<b>Component Description</b>	<b>List Price #</b>	<b>OEM Part #</b>
			C7112OS	\$39.99	OS364	Water Pump Oil Seal	\$5.89	17461-03B00
					OS132	Left Crank Seal 30x40x7	\$16.64	09283-30061
					OS174	Right Crank Seal 18x30x6	\$5.91	09283-18006
					OS305	Shift Shaft Seal 14x22x6	\$5.77	09283-14006
					OS215	Start Shaft Seal 15.8x24x5	\$4.86	09283-16004
					OS235	Output Shaft Seal 28x38x6	\$1.99	09283-28020
					R20X2V	Output Shaft O-ring 2	\$3.02	09280-20006
			<b>Clutch &amp; Mag Kit</b>	<b>List Price</b>	<b>Component Part#</b>	<b>Component Description</b>	<b>List Price #</b>	<b>OEM Part #</b>
			C7136CM	\$22.28	EC207060AFM	Mag Cover Gasket	\$8.29	11483-43D00
					C7499	Outer Clutch Cover Gasket	\$13.99	11484-43D00
RM125	98-00	O-Ring	C7136	\$31.91	R62X2V	Inner Head O-ring	\$4.64	11147-27C11
					R89X2B	Outer Head O-ring	\$2.86	11148-27C11
					B0045018AFM	Base Gasket	\$9.32	11241-27C10
					B0045012F	High Compression Base Gasket .012"	\$9.32	
					PV020018AFM	Right Side Power Valve Gasket	\$3.80	11233-27C32
					PV021032AFM	Front Power Valve Gasket	\$3.80	11238-27C31
					PV061018AFM	Front Power Valve Gasket 97-Up	\$3.80	11238-36E00
			<b>Bottom End Kit</b>	<b>List Price</b>	<b>Component Part#</b>	<b>Component Part#</b>	<b>List Price</b>	<b>OEM Part#</b>
			C3361	\$40.51	EC211018AFM	Mag Cover Gasket	\$8.29	11483-36E10
					EC212032AFM	Inner Clutch Cover Gasket	\$8.29	11482-36E10
					C7499	Outer Clutch Cover Gasket	\$13.99	11484-43D00
					EC214020F	Center Case Gasket	\$14.87	11481-36E10
					WP041018AFM	Water Pump Gasket	\$4.37	17431-43D00
RM125	01-03	O-Ring	C7778	\$31.91	R89X2B	Outer Head O-ring	\$2.86	11148-27C11
					R63X2V	Inner Head O-ring	\$4.57	11147-27C11

All Component Parts can be purchased individually.



**WARNING:** Cancer and Reproductive Harm www.P65Warnings.ca.gov



# MX/Dirt • Off-Road Gaskets



Cometic Gasket - An Exclusive NASCAR Performance® Product

## SUZUKI RM125

Model	Year	Bore Size	Top End Kit	List Price	Component Part#	Component Description	List Price	OEM Part #
RM125	01-03	O-Ring	C7778	\$31.91	R89X2B	Outer Head O-ring	\$2.86	11148-27C11
					R63X2V	Inner Head O-ring	\$4.57	11147-27C11
					B0045018AFM	Base Gasket	\$9.32	11241-27C10
					PV020018AFM	Right Side Power Valve Gasket	\$3.80	11233-27C32
					PV061018AFM	Front Power Valve Gasket 97-Up	\$3.80	11238-36E00
					WA123	Head Crush Washer	\$1.96	09168-08021
<b>Bottom End Kit w/Oil Seals</b>								
			C7778BE	\$81.71	EC871020F	Center Case Gasket K1-K4	\$23.80	11481-36F20/11481
					WA125	Drain Plug Gasket	\$2.23	09168-12002
					EC502032AFM	Inner Clutch Cover Gasket	\$8.29	11484-36E10
					R116B	Oil Fill Plug Gasket	\$1.13	09280-17003
					WP124060AFM	Water Pump Cover Gasket	\$5.34	17431-36F00
					WA124	Water Pump Drain Gasket	\$2.22	09168-06004
					R20X2V	Output Shaft O-rings	\$3.02	09280-20006
<b>Oil Seal Kit</b>								
			C7778OS	\$47.35	OS364	Impeller Seal K1-K3 12x24x10	\$5.89	17461-03B00
<b>Crank Seal Kit</b>								
			C7784	\$28.11	OS305	Shift Shaft Seal 14X22X6	\$5.77	09283-14006
					OS244	Clutch Pushrod Seal 10X17X5.0	\$1.43	09285-10004
					OS235	Output Shaft Seal K1-K3 28x	\$6.85	09283-28020
					OS215	Start Shaft Seal 15.8X24X5	\$4.86	09283-16004
					OS174	Left Crank Seal 18X30X6	\$5.91	09283-18007
					OS132	Right Crank Seal 30X40X7	\$16.64	09283-30061
<b>Clutch &amp; Mag Kit</b>								
			C7778CM	21.28	EC213	Outer Clutch Cover	\$12.99	11482-36F00
					EC211018AFM	Mag Cover Gasket	\$8.29	11483-36E11
RM125	04-07	O-Ring	C7508	\$35.10	R63X2V	Inner Head O-ring	\$4.57	11147-37F00
					R89X2B	Outer Head O-ring	\$2.86	11148-37F00
					B0705018AFM	Base Gasket	\$6.01	11241-36F00
					B0705012F	High Comp. Base Gasket .012"	\$9.56	
					EX640	Exhaust Gasket	\$6.93	11483-36E10
					PV020018AFM	Right Side Power Valve	\$3.80	11484-43D00
					PV061018AFM	Front Power Valve Gasket	\$3.80	11482-36F00
					WA123	Head Crush Washer	\$1.96	09168-08021
<b>Bottom End Kit w/Oil Seals</b>								
			C7508BE	\$82.48	EC502032AFM	Inner Clutch(Primary) Cover	\$3.80	11482-36F00
					EC871020F	Center Case Gasket	\$3.80	11481-36F30
					R116B	Fill Plug Gasket (Trans.)	\$1.13	09280-17003
					R20X2V	Output Shaft O-ring	\$3.02	09280-20006
					WA124	Water Pump Drain Crush Washer	\$2.22	09168-06004
					WA125	Drain Plug Gasket	\$2.32	09168-12002
					WP124032AFM	Water Pump Cover Gasket	\$5.34	17431-36F00
<b>Oil Seal Kit</b>								
			C7508OS	\$47.02	OS132	Right Crank Seal	\$16.64	09283-30061
<b>Crank Seal Kit</b>								
			C7784	\$28.11	OS174	Left Crank Seal	\$5.91	09283-18007
					OS215	Kickstart Seal	\$4.86	09283-16004
					OS216	Water Pump Oil Seal	\$5.65	17461-37F00
					OS244	Clutch Pushrod Oil Seal	\$1.43	09285-10004
					OS305	Shift Shaft Seal 14x22x6	\$5.77	09283-14006
					OS367	Output Shaft Seal	\$6.76	09289-28012
<b>Clutch &amp; Mag Kit</b>								
			C7508CM	\$22.28	C7499	Clutch Cover O-ring	\$13.99	11484-36E10
					EC211032AFM	Mag Cover Gasket	\$8.29	11483-36E11

All Component Parts can be purchased individually.



**WARNING:** Cancer and Reproductive Harm [www.P65Warnings.ca.gov](http://www.P65Warnings.ca.gov)





# MX/Dirt • Off-Road Gaskets



Cometic Gasket - An Exclusive NASCAR Performance® Product

## SUZUKI RM250

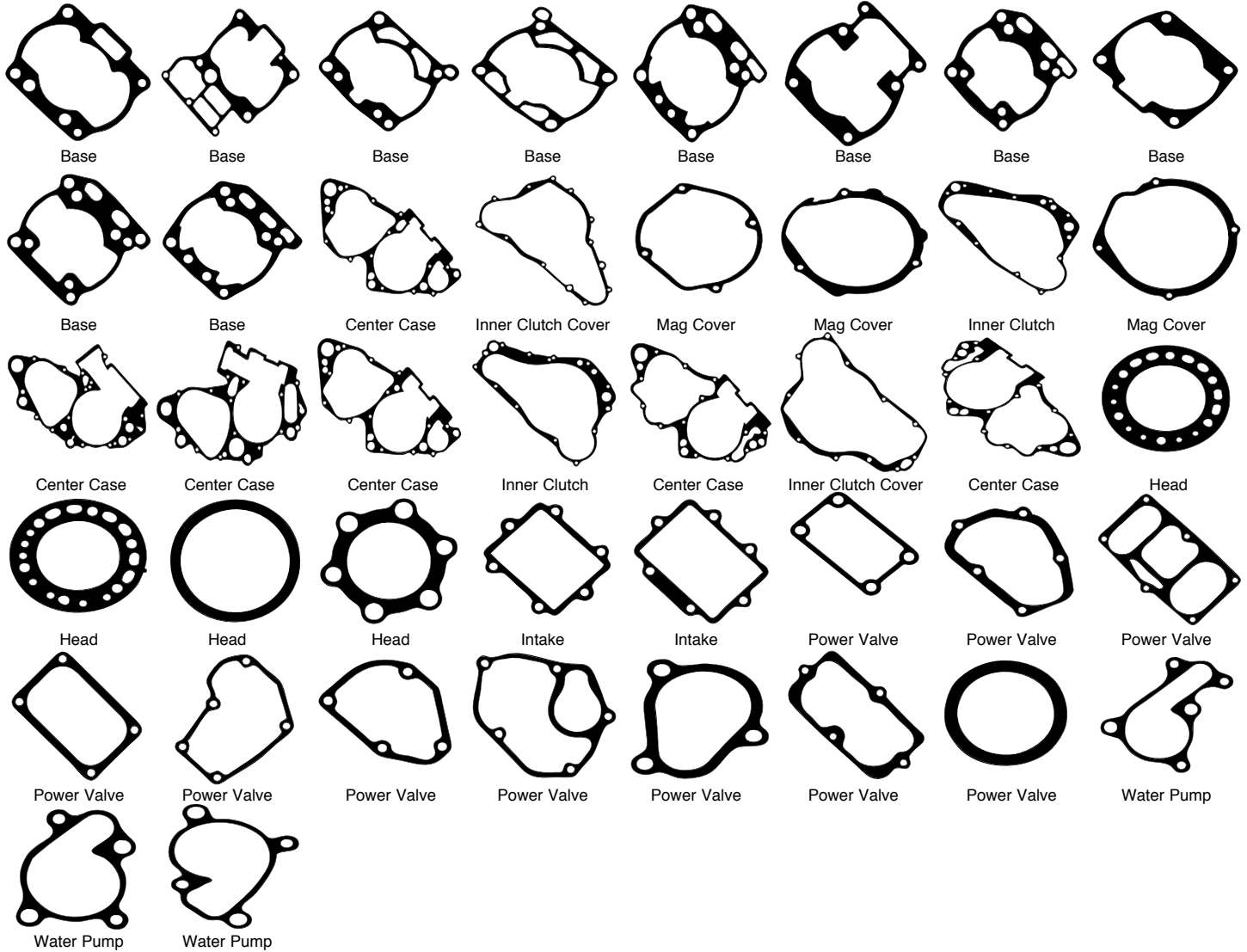

Model	Year	Bore Size	Top End Kit	List Price	Component Part#	Component Description	List Price	OEM Part #
RM250	77-80	69 mm	C7468	\$29.35	B0350020F	Base Gasket	\$9.32	11241-41100-H17
					H0738016A	Head Gasket	\$19.82	11141-41610
RM250	81	69 mm	C7814	\$29.35	B0446020F	Base Gasket	\$8.69	11241-14201
					H0966043F	Head Gasket	\$20.99	11141-14202
RM250	83	72 mm	C7104	\$25.55	B0046020F	Base Gasket	\$6.25	11241-14600-H17
					H0045043F	Head Gasket	\$19.82	11141-13A60
RM250	84-85	72 mm	C7060	\$34.47	B0046020F	Base Gasket	\$6.25	11241-14600-H17
					EX012031F	Exhaust Gasket	\$4.65	14181-16300
					H0045043F	Head Gasket	\$19.82	11141-13A60

All Component Parts can be purchased individually.

**WARNING:** Cancer and Reproductive Harm [www.P65Warnings.ca.gov](http://www.P65Warnings.ca.gov)



# MX/Dirt • Off-Road Gaskets



Cometic Gasket - An Exclusive NASCAR Performance® Product

## SUZUKI RM250

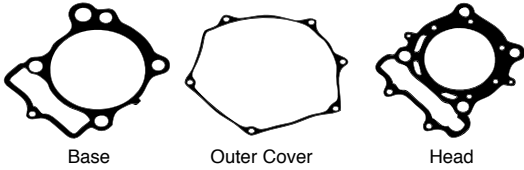

Model	Year	Bore Size	Top End Kit	List Price	Component Part#	Component Description	List Price	OEM Part #
RM250	86	69 mm	C7061	\$33.14	B0047020F	Base Gasket	\$6.25	H241-00B20-H17
					EX012031F	Exhaust Gasket	\$4.65	14181-16300
					H0046043F	Head Gasket	\$21.76	11141-01C01-H17
					PV022018AFM	Right Side Power Valve Gasket	\$3.80	11233-00B00-H17
			<b>Crank Seal Kit</b>	<b>List Price</b>	<b>Component Part#</b>	<b>Component Part#</b>	<b>List Price</b>	<b>OEM Part#</b>
			C7701	\$22.43	OS175	35X52X8 Right Crank Seal	\$12.99	09283-36003
					OS176	19X37X6 Left Crank Seal	\$11.87	09283-20046
RM250	87-88	69 mm 74 mm	C7062 C7327	\$36.86 \$36.86	H0046043F	Head Gasket	\$21.76	11141-01C01-H17
					H0203043F	74mm Bore Head Gasket	\$21.76	
					B0048020F	Base Gasket	\$6.25	11241-00B20-H17
					EX012031F	Exhaust Gasket	\$4.65	14181-16300
					IR004018AFM	Intake Gasket	\$3.80	14132-430
					PV023020F	Center Power Valve Cover	\$3.80	11238-00B20
					PV024020F	Right Side Power Valve Gasket	\$3.80	11233-00B20-H17
			<b>Crank Seal Kit</b>	<b>List Price</b>	<b>Component Part#</b>	<b>Component Part#</b>	<b>List Price</b>	<b>OEM Part#</b>
			C7701	\$22.43	OS175	35X52X8 Right Crank Seal	\$12.99	09283-36003
					OS176	19X37X6 Left Crank Seal	\$11.87	09283-20046
RM250	89-90	68 mm 73.5 mm	C7063 C7328	\$33.17 \$33.17	H0047043F	68mm Bore Head Gasket	\$21.76	11141-28C10
					H0200043F	73.5mm Bore Head Gasket	\$21.76	
					B0049020F	Base Gasket	\$6.25	11241-28C11
					B0049012F	High Comp. Base Gasket .012"	\$9.32	
					IR011018AFM	Intake Gasket	\$3.48	3008-076/13156-01C10
					PV025018AFM	Center Power Valve Gasket	\$3.80	11238-28C00
					PV026018AFM	Right Power Valve Gasket	\$3.80	11233-37E00
					R132V	Power Valve O-ring	\$1.19	09280-23002
					EC233020F	Clutch Cover Gasket	\$9.94	11482-28C01
					WP039018AFM	Water Pump Gasket	\$5.00	17431-28C00
			<b>Crank Seal Kit</b>	<b>List Price</b>	<b>Component Part#</b>	<b>Component Part#</b>	<b>List Price</b>	<b>OEM Part#</b>
			C7701	\$22.43	OS175	35X52X8 Right Crank Seal	\$12.99	09283-20051
					OS176	19X37X6 Left Crank Seal	\$11.87	09283-36007
RM250	91	O-Ring	C7065	\$38.33	R105X2B	Outer Head O-ring	\$2.57	11148-28C20
					R75X2V	Inner Head O-ring	\$5.29	11147-28C20
					B0049020F	Base Gasket	\$6.01	11241-28C11
					B0049012F	High Comp. Base Gasket .012"	\$9.32	
					IR011018AFM	Intake Gasket	\$3.48	3008-076/13156-01C10
					PV025018AFM	Center Power Valve Gasket	\$3.80	11238-28C00
					PV027018AFM	Right Side Power Valve 93-99	\$3.80	11233-28C01
					R132V	Power Valve O-ring	\$1.19	09280-23002
					C7497	Outer Clutch Cover Gasket	\$20.45	11484-28C10
			<b>Crank Seal Kit</b>	<b>List Price</b>	<b>Component Part#</b>	<b>Component Part#</b>	<b>List Price</b>	<b>OEM Part#</b>
			C7703	\$21.36	OS178	35X52X8 Right Crank Oil Seal	\$12.99	09283-36007
					OS179	19X37X6 Left Crank Oil Seal	\$10.68	09283-20051



# MX/Dirt • Off-Road Gaskets



Cometic Gasket - An Exclusive NASCAR Performance® Product

## SUZUKI RM250

Model	Year	Bore Size	Top End Kit	List Price	Component Part#	Component Description	List Price	OEM Part #				
RM250	92-93	O-Ring	C7123	\$38.33	R105X2B	Outer Head O-ring	\$2.57	11148-28C20				
					R75X2V	Inner Head O-ring	\$5.29	11147-28C20				
					B0050018AFM	Base Gasket	\$6.25	11241-28C11				
					B0050012F	High Comp. Base Gasket .012"	\$9.32					
					IR011018AFM	Intake Gasket	\$3.48	3008-076/13156-01C10				
					PV025018AFM	Center Power Valve Gasket	\$3.80	11238-28C00				
					PV027018AFM	Right Side Power Valve 93-99	\$3.80	11233-28C01				
					R132V	Power Valve O-ring	\$1.19	09280-23002				
					<b>Bottom End Kit w/crank seals</b>	<b>List Price</b>	<b>Component Part#</b>	<b>Component Part#</b>	<b>List Price</b>	<b>OEM Part#</b>		
					C3365	\$66.51	EC231039F	Mag Cover Gasket	\$8.69	11483-28C01		
							EC233020F	Inner Clutch Cover Gasket	\$9.94	11482-28C01		
							EC272020F	Center Case Gasket	\$14.87	11481-28C00		
							WP049018AFM	90-95 Water Pump Gasket	\$5.00	17431-28C10		
		C7497	Outer Clutch Cover Gasket	\$20.45	11484-28C10							
<b>Crank Seal Kit</b>	<b>List Price</b>	<b>Component Part#</b>	<b>Component Part#</b>	<b>List Price</b>	<b>OEM Part#</b>							
C7703	\$21.36	OS178	35X52X8 Right Crank Oil Seal	\$12.99	09283-36007							
		OS179	19X37X6 Left Crank Oil Seal	\$10.68	09283-20051							
RM250	94-95	O-Ring	C7156	\$38.33	R105X2B	Outer Head O-ring	\$2.57	11148-28C20				
					R75X2V	Inner Head O-ring	\$5.29	11147-28C20				
					B0050018AFM	Base Gasket	\$6.25	11241-28C11				
					B0050012F	High Comp. Base Gasket .012"	\$9.32					
					IR011018AFM	Intake Gasket	\$3.48	3008-076/13156-01C10				
					PV025018AFM	Center Power Valve Gasket	\$3.80	11238-28C00				
					PV027018AFM	Right Side Power Valve 93-99	\$3.80	11233-28C01				
					R132V	Power Valve O-ring	\$1.19	09280-23002				
					<b>Bottom End Kit w/crank seals</b>	<b>List Price</b>	<b>Component Part#</b>	<b>Component Part#</b>	<b>List Price</b>	<b>OEM Part#</b>		
					C3366	\$69.63	C7497	Outer Clutch Cover Gasket	\$20.45	11484-28C10		
							EC271060AFM	Mag Cover Gasket	\$8.69	11483-28E10		
							EC273020F	Center Case Gasket	\$16.13	11481-28E10		
							EC297032AFM	Inner Clutch Cover Gasket	\$9.94	11482-28E10		
		WP049018AFM	90-95 Water Pump Gasket	\$5.00	17431-28C10							
<b>Clutch &amp; Mag Kit</b>	<b>List Price</b>	<b>Component Part#</b>	<b>Component Description</b>	<b>List Price</b>	<b>OEM Part #</b>							
C7156CM	\$29.14	C7497	Clutch Cover Gasket	\$20.45	11484-28C10							
		EC271060AFM	Mag Cover Gasket	\$8.69	11483-28E10							
<b>Crank Seal Kit</b>	<b>List Price</b>	<b>Component Part#</b>	<b>Component Part#</b>	<b>List Price</b>	<b>OEM Part#</b>							
C7704	\$23.50	OS133	37X52X8 Right Crank Oil Seal	\$15.44	09283-38018							
		OS179	19X37X6 Left Crank Oil Seal	\$10.68	09283-20051							
RM250	96-98	O-Ring	C7280	\$40.51	R105X2B	Outer Head O-ring	\$2.57	11148-28C20				
					R75X2V	Inner Head O-ring	\$5.29	11147-28C20				
					B0237018AFM	Base Gasket	\$6.25	11241-37E00				
					B0237012F	Base Gasket High Comp. .012"	\$9.32					
					IR107018AFM	Intake Gasket	\$7.44	13156-37E10				
					PV050018AFM	Right Power Valve Gasket	\$3.80	11233-37E00				
					PV051018AFM	Center Power Valve Cover Gasket	\$3.80	11238-37E00				
					<b>Bottom End Kit w/crank seals</b>	<b>List Price</b>	<b>Component Part#</b>	<b>Component Part#</b>	<b>List Price</b>	<b>OEM Part#</b>		
					C3367	\$62.35	EC215020F	Center Case Gasket	\$16.13	11481-37E01		
							EC216032AFM	Inner Clutch Cover Gasket	\$9.94	11482-37E01		
							C7496	Outer Clutch Cover Gasket	\$20.45	11484-37E00		
							EC218060AFM	Mag. Cover Gasket	\$8.69	11483-37E00		
					<b>Clutch &amp; Mag Kit</b>	<b>List Price</b>	<b>Component Part#</b>	<b>Component Description</b>	<b>List Price</b>	<b>OEM Part #</b>		
C7280CM	\$27.68	C7496	Clutch Cover Gasket	\$20.45	11484-37E00							
		EC218060AFM	Mag. Cover Gasket	\$8.69	11483-37E00							
<b>Crank Seal Kit</b>	<b>List Price</b>	<b>Component Part#</b>	<b>Component Part#</b>	<b>List Price</b>	<b>OEM Part#</b>							
C7665	\$20.29	OS131	24X37X6 Left Crank Oil Seal	\$7.10	09283-25099							
		OS133	37X52X8 Right Crank Oil Seal	\$15.44	09283-38021							

All Component Parts can be purchased individually.

**WARNING:** Cancer and Reproductive Harm www.P65Warnings.ca.gov



# MX/Dirt • Off-Road Gaskets



Cometic Gasket - An Exclusive NASCAR Performance® Product

## SUZUKI RM250

Model	Year	Bore Size	Top End Kit	List Price	Component Part#	Component Description	List Price	OEM Part #
RM250	99-00	O-Ring	C7505	\$44.69	R105X2B	Outer Head O-ring	\$2.57	11148-28C20
					R75X2V	Inner Head O-ring	\$5.29	11147-28C20
					B0364018AFM	Base Gasket	\$7.44	11241-37E30
					B0364012F	Base Gasket High Comp. .012"	\$9.94	
					IR107018AFM	Intake Gasket	\$7.44	13156-37E10
					PV061018AFM	Center Power Valve Cover	\$3.80	11238-36E00
					PV079018AFM	Rt. Side Power Valve Cover	\$6.19	11233-37E30
					PV081018AFM	Left Side Power Valve Gasket	\$5.00	11234-37E30
			<b>Bottom End Kit w/crank seals</b>	<b>List Price</b>	<b>Component Part#</b>	<b>Component Part#</b>	<b>List Price</b>	<b>OEM Part#</b>
			C3368	\$64.15	EC216032AFM	Inner Clutch Cover Gasket	\$9.94	11482-37E01
					C7496	Outer Clutch Cover Gasket	\$20.45	11484-37E00
					EC218060AFM	Mag Cover Gasket	\$8.69	11483-37E00
					EC294020F	Center Case Gasket	\$18.56	11481-37E30
			<b>Clutch &amp; Mag Kit</b>	<b>List Price</b>	<b>Component Part#</b>	<b>Component Description</b>	<b>List Price</b>	<b>OEM Part #</b>
			C7280CM	\$27.68	C7496	Clutch Cover Gasket	\$20.45	11484-37E00
					EC218060AFM	Mag. Cover Gasket	\$8.69	11483-37E00
			<b>Crank Seal Kit</b>	<b>List Price</b>	<b>Component Part#</b>	<b>Component Part#</b>	<b>List Price</b>	<b>OEM Part#</b>
			C7665	\$20.29	OS131	24X37X6 Left Crank Oil Seal	\$7.10	09283-25099
					OS133	37X52X8 Right Crank Oil Seal	\$15.44	09283-38021
RM250	01-02	O-Ring	<b>Top End Kit</b>	<b>List Price</b>	<b>Component Part#</b>	<b>Component Description</b>	<b>List Price</b>	<b>OEM Part #</b>
			C7779	\$49.80	R100X2B	Outer Head O-ring	\$3.64	11148-37F00
					R73X2V	Inner Head O-ring	\$3.71	11147-37F00
					B0495018AFM	Base Gasket	\$9.32	11241-37F01
					B0495012F	High Comp. Base Gasket .012"	\$5.34	
					IR107018AFM	Intake Gasket	\$7.44	13156-37E10
					PV061018AFM	Center Power Valve Cover	\$3.80	11238-36E00
					PV079018AFM	Right Side Power Valve Cover	\$6.19	11233-37E30
					PV081018AFM	Left Side Power Valve Gasket	\$5.00	11234-37E31
					C7496	Outer Clutch Cover Gasket	\$20.45	11484-28C10
			<b>Bottom End Kit w/oil seals</b>	<b>List Price</b>	<b>Component Part#</b>	<b>Component Part#</b>	<b>List Price</b>	<b>OEM Part#</b>
			C7779BE	\$68.95	EC218060AFM	Mag Cover Gasket	\$8.69	11483-37E02
					WA124	Water Pump Cover Crush Washer	\$2.22	09168-06004
					WP122032AFM	Water Pump Cover Gasket	\$1.71	17431-37F00
					EC501032AFM	Primary Cover Gasket	\$8.29	11482-37F01
					R116B	Fill Plug O-ring	\$1.13	09280-17003
					C7496	Clutch Cover Gasket	\$18.99	11484-37E00
					IR107018AFM	Intake Gasket	\$7.44	13156-37E10
					EC500020F	Center Case Gasket	\$18.56	11481-37F01
					WA124	Oil Level Screw Crush Washer	\$2.22	09168-06004
					WA125	Drain Plug Crush Washer	\$2.23	09168-12002
					OS131	Left Crank Seal 25x37x6	\$7.10	09283-25099
					OS133	Right Crank Seal 38x52x8	\$15.44	09283-38021
					OS249	Start Shaft Seal 20x27x5	\$3.83	09283-20031
					OS228	Clutch Lifter Seal 12x19x5	\$4.51	09285-12004
					OS235	Output Shaft Seal 28x38x6	\$1.99	09283-28020
					OS305	Shift Shaft Seal 14x22x6	\$5.77	09283-14006
					OS364	Water Pump Seal	\$5.89	17461-03B00
			<b>Oil Seal Kit</b>	<b>List Price</b>	<b>Component Part#</b>	<b>Component Description</b>	<b>List Price</b>	<b>OEM Part #</b>
			C7779OS	\$35.99	OS131	Left Crank Seal 25x37x6	\$7.10	09283-25099
					OS133	Right Crank Seal 38x52x8	\$15.44	09283-38021
					OS228	Clutch Lifter Seal 12x19x5	\$4.51	09285-12004
					OS235	Output Shaft Seal 28x38x6	\$1.99	09283-28020
					OS249	Start Shaft Seal 20x27x5	\$3.83	09283-20031
					OS305	Shift Shaft Seal 14x22x6	\$5.77	09283-14006
					OS364	Water Pump Seal	\$5.89	17461-03B00
			<b>Clutch &amp; Mag Kit</b>	<b>List Price</b>	<b>Component Part#</b>	<b>Component Description</b>	<b>List Price</b>	<b>OEM Part #</b>
			C7280CM	\$27.68	C7496	Clutch Cover Gasket	\$20.45	11484-37E00
					EC218060AFM	Mag. Cover Gasket	\$8.69	11483-37E00

All Component Parts can be purchased individually.



**WARNING:** Cancer and Reproductive Harm [www.P65Warnings.ca.gov](http://www.P65Warnings.ca.gov)



# MX/Dirt • Off-Road Gaskets



Cometic Gasket - An Exclusive NASCAR Performance® Product

## SUZUKI RM250

Model	Year	Bore Size	Top End Kit	List Price	Component Part#	Component Description	List Price	OEM Part #					
RM250	03-04	O-Ring	C7467	\$49.80	R100X2B	Outer Head O-ring	\$3.64	11148-37F00					
					R73X2V	Inner Head O-ring	\$3.71	11147-37F00					
					B0632018AFM	Base Gasket	\$7.16	11241-37F20					
					B0632012F	High Comp. Base Gasket .012"	\$7.16						
					PV116018AFM	Right Side Power Valve Gasket	\$3.80	11233-37F20					
					PV117018AFM	Left Side Power Valve Gasket	\$3.80	11234-37F20					
					PV118018AFM	Front Power Valve Gasket	\$3.80	11238-37F20					
					PV125018AFM	Power Valve Spring Gasket	\$2.44	11279-37F30					
					R44X3S	Expansion Chamber O-rings 2 Req.	\$2.82	14171-28C30					
					<b>Bottom End Kit w/oil seals</b>	<b>List Price</b>	<b>Component Part#</b>	<b>Component Part#</b>	<b>List Price</b>	<b>OEM Part#</b>			
					C3370	\$52.99	C7496	Outer Clutch Cover Gasket	\$20.45	11484-28C10			
							EC218060AFM	Mag Cover Gasket	\$8.69	11483-37E00			
							EC501032AFM	Inner Clutch Cover Gasket	\$8.29	11482-37F00			
							EC738020F	Center Case Gasket	\$3.35	11481-37F20			
							WP122032AFM	Water Pump Gasket	\$1.71	17431-37F00			
<b>Clutch &amp; Mag Kit C7280CM</b>	<b>List Price \$29.14</b>	<b>Component Part# C7496</b>	<b>Component Description Clutch Cover Gasket</b>	<b>List Price \$20.45</b>	<b>OEM Part # 11484-37E00</b>								
		<b>EC218060AFM</b>	<b>Mag. Cover Gasket</b>	<b>\$8.69</b>	<b>11483-37E00</b>								
<b>Crank Seal Kit C7665</b>	<b>List Price \$20.29</b>	<b>Component Part# OS131</b>	<b>Component Description 24X37X6 Left Crank Oil Seal</b>	<b>List Price \$7.10</b>	<b>OEM Part # 09283-25099</b>								
		<b>OS133</b>	<b>37X52X8 Right Crank Oil Seal</b>	<b>\$15.44</b>	<b>09283-38021</b>								
RM250	05-08	O-Ring	C3099	\$49.80	R100X2B	Outer Head O-ring	\$3.64	11148-37F00					
					R73X2V	Inner Head O-ring	\$3.71	11147-37F00					
					B0632018AFM	Base Gasket	\$7.16	11241-37F20					
					B0632012F	High Comp. Base Gasket .012"	\$7.16						
					EX640	Exhaust Gasket	\$6.93	14172-28630					
					R44X3S	Exp. O-rings 2 Req.	\$2.82	14171-28C30					
					PV116018AFM	Right Side Power Valve Gasket	\$3.80	11233-37F20					
					PV117018AFM	Left Side Power Valve Gasket	\$3.80	11234-37F20					
					PV118018AFM	Front Power Valve Gasket	\$3.80	11238-37F20					
					PV125018AFM	Power Valve Spring Gasket	\$2.44	11279-37F30					
					<b>Bottom End Kit w/crank seals</b>	<b>List Price</b>	<b>Component Part#</b>	<b>Component Description</b>	<b>List Price</b>	<b>OEM Part #</b>			
					C3371	\$60.49	C7496	Outer Clutch Cover Gasket	\$20.45	11484-28C10			
							EC218060AFM	Mag Cover Gasket	\$8.69	11483-37E00			
							EC501032AFM	Inner Clutch Cover Gasket	\$8.29	11482-37F00			
							EC738020F	Center Case Gasket	\$3.35	11481-37F20			
							R116B	Oil Fill Plug O-ring	\$1.13	09280-17003			
							R20X2V	Counter Shaft O-ring	\$3.02	09280-20006			
							WA124	Water Pump Drain/Trans. Oil Check Plug Washer 2 Req.	\$2.22	09168-06004			
							WA125	Drain Plug Washer	\$2.32	09168-12002			
							WA126	Power Valve Seal Crush Washer	\$0.80	09168-08015			
							WP122032AFM	Water Pump Gasket	\$1.71	17431-37F00			
					<b>Clutch &amp; Mag Kit C7280CM</b>	<b>List Price \$27.68</b>	<b>Component Part# C7496</b>	<b>Component Description Clutch Cover Gasket</b>	<b>List Price \$20.45</b>	<b>OEM Part # 11484-37E00</b>			
							<b>EC218060AFM</b>	<b>Mag. Cover Gasket</b>	<b>\$8.69</b>	<b>11483-37E00</b>			
					<b>Crank Seal Kit C3372</b>	<b>List Price \$21.37</b>	<b>Component Part# OS131</b>	<b>Component Description 24X37X7 Left Crank Seal</b>	<b>List Price \$7.10</b>	<b>OEM Part # 09283-25099</b>			
							<b>OS132</b>	<b>29X40X7 Right Crank Seal</b>	<b>\$16.64</b>	<b>09283-28025</b>			
					RMX250	89-92	68 mm	C7257	\$38.33	B0049020F	Base Gasket	\$6.25	11241-28C11
										H0313059F	Head Gasket	\$24.75	1141-05D00
										IR011018AFM	ntake Gasket	\$3.48	3008-076/13156-01C10
										PV025018AFM	Center Power Valve Gasket	\$3.80	11238-28C00
										PV026018AFM	Right Power Valve Gasket	\$3.80	11233-37E00
R134V	Expansion Chamber O-ring	\$3.92	14171-28C01										
<b>Component Part# C7496</b>	<b>Component Part# Clutch Cover Gasket</b>	<b>List Price \$20.45</b>	<b>OEM Part# 11484-28C10</b>										

All Component Parts can be purchased individually.

**WARNING:** Cancer and Reproductive Harm www.P65Warnings.ca.gov





# MX/Dirt • Off-Road Gaskets



Cometic Gasket - An Exclusive NASCAR Performance® Product

## SUZUKI RMX250

Model	Year	Bore Size	Top End Kit	List Price	Component Part#	Component Part#	List Price	OEM Part#
RMX250	93-99	68 mm	C7258	\$38.33	B0050018AFM	Base Gasket	\$6.25	11241-28C11
					B0050012F	High Compression Base Gasket	\$9.32	11241-28C11
					H0313059F	Head Gasket	\$24.75	1141-05D00
					IR011018AFM	Intake Gasket	\$3.48	3008-076/13156-01C10
					PV025018AFM	Center Power Valve Gasket	\$3.80	11238-28C00
					PV026018AFM	Right Power Valve Gasket 93-95	\$3.80	11233-37E00
					PV027018AFM	96-99 Right Power Valve Gasket	\$3.80	11233-28C01
					R132V	Power Valve O-ring	\$1.19	09280-23002
					<b>Component Part#</b>	<b>Component Part#</b>	<b>List Price</b>	<b>OEM Part#</b>
					C7496	Clutch Cover Gasket	\$20.45	11484-28C10
DR-Z250	03-07	73 mm	<b>Top End Kit</b> C7968	<b>List Price</b> \$36.99	<b>Component Part#</b> H1694027S	<b>Component Description</b> Head Gasket 73mm Bore	<b>List Price</b> \$30.95	<b>OEM Part #</b> 11141-13E00
		80 mm	C7969	\$36.99	H1552027S	Head Gasket 80mm Bore	\$30.95	
			<b>EST</b>	<b>List Price</b>	<b>Component Part#</b>	<b>Component Description</b>	<b>List Price</b>	<b>OEM Part #</b>
RM-Z250	04-06	77 mm	C3174-EST	\$74.99	H2169SP1027S	Head Gasket 77mm	\$43.39	K1100-40003
		78 mm	C3054-EST	\$74.99	H2096027S	Head Gasket 78mm Bore	\$43.39	
		80 mm	C3056-EST	\$74.99	H2169027S	Head Gasket 80mm Bore	\$43.39	
		81mm	C7221-EST	\$74.99	H1967027S	Head Gasket 81mm Bore	\$43.39	
		83 mm	C3135-EST	\$74.99	H2471SP1027S	Head Gasket 83mm Bore	\$43.39	
		84 mm	C3118-EST	\$74.99	H2471027S	Head Gasket 84mm Bore	\$43.39	
					B0691014RC	Base Gasket	\$20.99	K1106-10025
					3233V	Valve Seals	\$5.11 ea.	K9204-91349
					R018B	Cam Chain Tensioner O-ring	\$3.92	KK920-55086
					EX651	Exhaust Gasket	\$8.98	14181-49H00
<b>Bottom End Kit w/Oil Seals</b>					<b>Component Part#</b>	<b>Component Description</b>	<b>List Price #</b>	<b>OEM Part #</b>
			C3174BE	\$98.69	WA108	Crank Case Drain Plug Washer	\$2.56	92065-058
					R118B	Crank End Cap O-Ring	\$1.13	670B2022
					EC903032AFM	Inner Clutch Cover Gasket	\$20.99	11061-0030
					R112B	Timing Mark Plug O-Ring	\$3.92	92055-1141
					R117B	Crank Case Oil Fill O-Ring	\$0.42	92055-1146
					R018B	Output Shaft O-Ring (2)	\$3.92	92055-055
					MR042	Water Pump Cover O-Ring	\$3.40	92055-0010
					R116B	Water Pipe O-Ring	\$1.13	92055-1308
<b>Oil Seal Kit</b>				<b>List Price</b>	<b>Component Part#</b>	<b>Component Description</b>	<b>List Price #</b>	<b>OEM Part #</b>
			C3174OS	\$45.36	OS227	Oil Pump Seal 12x22x5	\$2.67	92049-1519
					OS279	Decomp. Shaft Seal 10x18x5	\$1.48	92049-1196
					OS295	Crank Seal 30x40x7	\$9.89	92049-1556/92049-0030
					OS305	Shift Shaft Seal 14x22x6	\$5.77	92049-0015
					OS306	Clutch Actuator Shaft Seal 12x18x4	\$2.91	92049-1262
					OS307	Start Shaft Seal 18x30x7	\$7.03	92049-013/92049-007
					OS308	Impeller Seal 8x22x7/7.5	\$5.89	92049-0021/92049-0061
					OS309	Inner WP Seal 8x22x5	\$5.89	92049-0016/92049-0060
					OS359	Output Shaft Seal 25x40x6	\$3.83	92049-1478
<b>Clutch &amp; Mag Kit</b>				<b>List Price</b>	<b>Component Part#</b>	<b>Component Description</b>	<b>List Price</b>	<b>OEM Part #</b>
			C3174CM	\$24.80	EC847060AFM	Clutch Cover Gasket	\$11.18	K1106-10031
					EC904032AFM	Mag Cover Gasket	\$13.62	K1106-10032



# MX/Dirt · Off-Road Gaskets



Cometic Gasket - An Exclusive NASCAR Performance® Product

## SUZUKI RM-Z250

Model	Year	Bore Size	EST	List Price	Component Part#	Component Description	List Price	OEM Part #	
RM-Z250	04-06	77 mm	Top End Kit						
			C3174-EST	\$74.99	H2169SP1027S	Head Gasket 77mm	\$43.39	K1100-40003	
		78 mm	C3054-EST	\$74.99	H2096027S	Head Gasket 78mm Bore	\$43.39		
		80 mm	C3056-EST	\$74.99	H2169027S	Head Gasket 80mm Bore	\$43.39		
		81mm	C7221-EST	\$74.99	H1967027S	Head Gasket 81mm Bore	\$43.39		
		83 mm	C3135-EST	\$74.99	H2471SP1027S	Head Gasket 83mm Bore	\$43.39		
		84 mm	C3118-EST	\$74.99	H2471027S	Head Gasket 84mm Bore	\$43.39		
					B0691014RC	Base Gasket	\$20.99		K1106-10025
					3233V	Valve Seals	\$5.11 ea.		K9204-91349
					R018B	Cam Chain Tensioner O-ring	\$3.92		KK920-55086
			EX651	Exhaust Gasket	\$8.98	14181-49H00			

Bottom End Kit w/Oil Seals	List Price	Component Part#	Component Description	List Price #	OEM Part #
C3174BE	\$98.69	WA108	Crank Case Drain Plug Washer	\$2.56	92065-058
		R118B	Crank End Cap O-Ring	\$1.13	670B2022
		EC903032AFM	Inner Clutch Cover Gasket	\$20.99	11061-0030
		R112B	Timing Mark Plug O-Ring	\$3.92	92055-1141
		R117B	Crank Case Oil Fill O-Ring	\$0.42	92055-1146
		R018B	Output Shaft O-Ring (2)	\$3.92	92055-055
		MR042	Water Pump Cover O-Ring	\$3.40	92055-0010
		R116B	Water Pipe O-Ring	\$1.13	92055-1308
<b>Oil Seal Kit</b>	<b>List Price</b>	<b>Component Part#</b>	<b>Component Description</b>	<b>List Price #</b>	<b>OEM Part #</b>
C3174OS	\$45.36	OS227	Oil Pump Seal 12x22x5	\$2.67	92049-1519
		OS279	Decomp. Shaft Seal 10x18x5	\$1.48	92049-1196
		OS295	Crank Seal 30x40x7	\$9.89	92049-1556/92049-0030
		OS305	Shift Shaft Seal 14x22x6	\$5.77	92049-0015
		OS306	Clutch Actuator Shaft Seal 12x18x4	\$2.91	92049-1262
		OS307	Start Shaft Seal 18x30x7	\$7.03	92049-013/92049-007
		OS308	Impeller Seal 8x22x7/7.5	\$5.89	92049-0021/92049-0061
		OS309	Inner WP Seal 8x22x5	\$5.89	92049-0016/92049-0060
		OS359	Output Shaft Seal 25x40x6	\$3.83	92049-1478
<b>Clutch &amp; Mag Kit</b>	<b>List Price</b>	<b>Component Part#</b>	<b>Component Description</b>	<b>List Price</b>	<b>OEM Part #</b>
C3174CM	\$24.80	EC847060AFM	Clutch Cover Gasket	\$11.18	K1106-10031
		EC904032AFM	Mag Cover Gasket	\$13.62	K1106-10032

Model	Year	Bore Size	EST	List Price	Component Part#	Component Description	List Price	OEM Part #	
RM-Z250	07-09	77 mm	Top End Kit						
			C3175-EST	\$61.31	H2617SP2027S	Head Gasket 77mm Bore	\$31.15	11141-10H00	
		78 mm	C3176-EST	\$61.31	H2617027S	Head Gasket 78mm Bore	\$31.15		
		79 mm	C3177-EST	\$61.31	H2617SP1027S	Head Gasket 79mm Bore	\$31.15		
		81 mm	C3203-EST	\$61.31	H2617SP7027S	Head Gasket 81mm Bore	\$31.15		
		83 mm	C3278-EST	\$61.31	H2617SP8027S	Head Gasket 83mm Bore	\$31.15		
					B0884010RC	Base Gasket	\$13.47		11241-10H00
					EX651	Exhaust Gasket	\$8.98		14181-49H00
					R018B	Cam Chain Tensioner Gasket	\$3.92		09280-19001
					WA114	Cam Chain Tensioner Bolt	\$3.02		12837-27F10
			3251V	Valve Seals	\$1.48	09289-04002			

Bottom End Kit w/Oil Seals	List Price	Component Part#	Component Description	List Price #	OEM Part #
C3175BE	\$98.69	EC1148020F	Center Case Gasket	\$20.22	11481-10H00
		WA125	Drain Plug Gasket	\$2.23	09168-12002
		WA124	Crank Sensor Gasket	\$2.22	09168-06004
		R116B	Fill Plug O-ring	\$1.13	09280-17003
		EC1150032AFM	Inner Clutch Cover Gasket	\$20.22	11482-10H00
		R119B	Crank End Cap O-Ring	\$1.04	09280-22008
		R10X2V	Timing Mark Plug O-Ring	\$1.59	09280-10016
		R20X2V	Output Shaft O-rings	\$3.02	09280-20006
		R029B	Oil Filter O-Ring	\$1.13	09280-39001
<b>Oil Seal Kit</b>	<b>List Price</b>	<b>Component Part#</b>	<b>Component Description</b>	<b>List Price #</b>	<b>OEM Part #</b>
C3174OS	\$48.51	WA124	Clutch Drain Plug Gasket	\$2.22	09168-06004
		R16X2V	Oil Screen O-ring 16x22x2	\$3.02	09168-16003
		OS132	Right Crank Seal 30x40x7	\$16.64	09283-30061
		OS218	Shift Shaft Seal 14x22x6	\$4.74	09283-14006
		OS370	Inner WP Seal	\$10.11	09282-12012
		OS216	Impeller Seal	\$5.54	17461-37F00
		OS367	Output Shaft Seal	\$6.76	09289-28012
		OS172	Start Shaft Seal	\$4.72	09283-18004
<b>Clutch &amp; Mag Kit</b>	<b>List Price</b>	<b>Component Part#</b>	<b>Component Description</b>	<b>List Price</b>	<b>OEM Part #</b>
C3175CM	\$21.34	EC1154032AFM	Mag Cover Gasket	\$9.47	11483-10H00
		EC1153032AFM	Clutch Cover Gasket	\$11.87	11484-10H00



# MX/Dirt • Off-Road Gaskets



Cometic Gasket - An Exclusive NASCAR Performance® Product

## SUZUKI RM-Z250

Model	Year	Bore Size	EST Top End Kit	List Price	Component Part#	Component Description	List Price	OEM Part #		
RM-Z250	10-19	77 mm	C3406-EST	\$57.10	H3139027S	Head Gasket 77 mm Bore	\$31.15	11141-49H00		
		79 mm	C3407-EST	\$57.10	H3139SP1027S	Head Gasket 79 mm Bore	\$31.15	11141-49H00		
		80 mm	C3408-EST	\$57.10	H3139SP2027S	Head Gasket 80 mm Bore	\$31.15	11141-49H00		
		82 mm	C3409-EST	\$57.10	H3139SP3027S	Head Gasket 82 mm Bore	\$31.15	11141-49H00		
		84 mm	C3410-EST	\$57.10	H3139SP5027S	Head Gasket 84 mm Bore	\$31.15	11141-49H00		
						3251V	Valve Stem Seals 4 Required	\$1.48	09289-04002	
						B1032010RC	Base Gasket	\$13.47	11241-49H00	
						EX651	Exhaust Gasket	\$8.98	14181-49H00	
						OS020	Head Drain Seal	\$1.03	09168-06023	
						R013V	Water Temp Sensor O-ring	\$1.08	13655-14G00	
						R019V	Cam Chain Tensioner O-ring	\$0.57		
						R122V	Cam Tower O-ring Seal	\$1.25	09280-26007	
					<b>Bottom End Kit w/o crank seals</b>	<b>List Price</b>	<b>Component Part#</b>	<b>Component Part#</b>	<b>List Price</b>	<b>OEM #</b>
					C3443	\$49.42	EC1153032AFM	Clutch Cover Gasket	\$11.87	11484-10H00
							EC1150032AFM	Inner Clutch Cover Gasket	\$20.22	11482-10H00
					EC1633032AFM	Mag Cover Gasket	\$9.47	11483-49H00		
					EC1632020F	Center Case Gasket	\$20.22			
			<b>Clutch &amp; Mag Kit</b>	<b>List Price</b>	<b>Component Part#</b>	<b>Component Description</b>	<b>List Price</b>	<b>OEM Part #</b>		
			C3406CM	\$21.34	EC1153032AFM	Clutch Cover Gasket	\$11.87	11484-10H00		
					EC1633032AFM	Mag Cover Gasket	\$9.47	11483-49H00		

## SUZUKI DR350, DR-Z400



Base Head

Model	Year	Bore Size	EST Top End Kit	List Price	Component Part#	Component Description	List Price	OEM Part #		
DR350	90-99	80 mm	C7068	\$29.35	H0244043F	Head Gasket 80mm Bore	\$33.22	11141-14D01		
		82 mm	C7157	\$29.35	H0049043F	Head Gasket 82mm Bore	\$33.22			
		88 mm	C7263	\$29.35	H0222043F	Head Gasket 88mm Bore	\$33.22			
		91 mm	C7264	\$29.35	H0229043F	Head Gasket 91mm Bore	\$33.22			
						B0052020F	Base Gasket	\$6.25	11241-14D01	
DR-Z400	00-13		<b>EST Top End Kit</b>	<b>List Price</b>	<b>Component Part#</b>	<b>Component Description</b>	<b>List Price</b>	<b>OEM Part #</b>		
		92 mm	C7688-EST	\$64.23	H0949027S	Head Gasket	\$30.95	11141-29F01		
		94 mm	C7806-EST	\$64.23	H1045027S	Head Gasket 94mm Bore	\$30.95			
		95 mm	C7963-EST	\$64.23	H1699027S	Head Gasket 95mm Bore	\$30.95			
		97 mm	C7980-EST	\$64.23	H1046027S	Head Gasket 97mm Bore	\$30.95			
						B0440010RC	Base Gasket	\$8.69	11241-29F00	
						EX243	Exhaust Gasket 2 Req.	\$2.79	14181-29E02	
						EC377032AFM	Cam Chain Tensioner Gasket	\$3.35	12837-24A10	
						WA121	Cam Chain Tensioner Washer	\$0.80	09168-06023	
						3160V	Valve Seals	\$5.50	09289-05011	
						<b>Component Part#</b>	<b>Component Description</b>	<b>List Price</b>	<b>OEM Part#</b>	
						EC837032AFM	Clutch Cover Gasket	\$13.29	11484-29F00	
					<b>EST Top End Kit</b>	<b>List Price</b>	<b>Component Part#</b>	<b>Component Description</b>	<b>List Price</b>	<b>OEM Part #</b>
		DRZ400 SM	05-13	92 mm	C7978-EST	\$64.23	H0949027S	Head Gasket 92mm Bore	\$30.95	11141-29F01
				94 mm	C7979-EST	\$64.23	H1045027S	Head Gasket 94mm Bore	\$30.95	
97 mm	C7980-EST			\$64.23	H1046027S	Head Gasket 97mm Bore	\$30.95			
						B0440027S	Base Gasket	\$28.51	11241-29F11	
						EX243	Exhaust Gasket 2 Req.	\$2.79	14181-29E02	
						EC377032AFM	Cam Chain Tensioner Gasket	\$3.35	12837-24A10	
						3160V	Valve Seals 4 Req.	\$5.50	09289-05011	
						WA121	Cam Chain Tensioner Washer	\$0.80	09168-06023	
						<b>Component Part#</b>	<b>Component Description</b>	<b>List Price</b>	<b>OEM Part #</b>	
						EC837032AFM	Clutch Cover Gasket	\$13.29	11484-29F00	

All Component Parts can be purchased individually.



**WARNING:** Cancer and Reproductive Harm [www.P65Warnings.ca.gov](http://www.P65Warnings.ca.gov)



# MX/Dirt · Off-Road Gaskets



Cometic Gasket - An Exclusive NASCAR Performance® Product

## SUZUKI RM-Z450

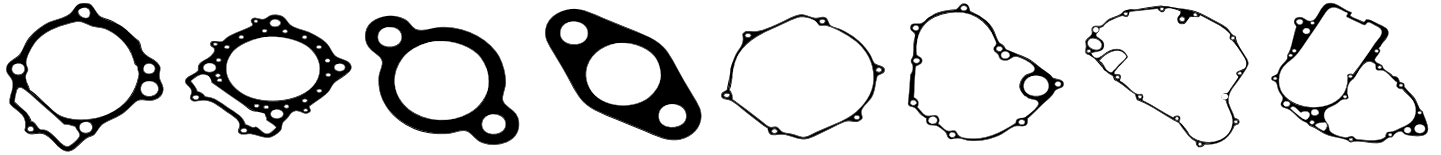

Base		Head	Cam Chain Tensioner		Timing Chain	Outer Clutch Cover	Mag Cover	Inner Clutch Cover	Center Case
Model	Year	Bore Size	EST	List Price	Component Part#	Component Description	List Price	OEM Part #	
RM-Z450	05-07	95.5 mm	Top End Kit						
			C3102-EST	\$86.99	H2393030S	Head Gasket	\$31.99	11141-35G01	
			C3104-EST	\$86.99	H2393SP1030S	97.5mm Bore Head Gasket	\$31.99		
		97.5 mm	C3127-EST	\$86.99	H2393SP3030S	98mm Bore Head Gasket	\$31.99		
					B0816010S	Base Gasket	\$16.69	11241-35G00	
					EX877	Exhaust Gasket	\$7.56	14172-28630	
		98 mm			EC1017032AFM	Cam Chain Tensioner Gasket	\$3.12	12837-32410	
					EC377018AFM	Cam Chain Tensioner Gasket 07	\$3.35	12837-24A10	
			3160V	Valve Seals 4 Req. 05-06 Model	\$5.50	09289-05011			
			3238V	Valve Seals 4 Req. 2007 Model	1.36 ea.	09289-05015			

Bottom End Kit w/Oil Seals		List Price	Component Part#	Component Description	List Price #	OEM Part #
C3102BE	\$133.37	WA140	Water Pump Drain Washer	\$0.63	09168-06018	
		R10X2V	Timing Plug O-ring	\$1.59	09280-10016	
		R116B	Fill Plug O-ring	\$1.13	09280-17003	
		R020V	Output Shaft O-ring	\$1.19	09280-21010	
		R119B	Crank End Cap O-Ring	\$1.04	09280-22008	
		R029B	Oil Filter O-Ring	\$1.13	09280-39001	
		EC1021020RC	Center Case Gasket	\$26.18	11481-35G11	
		EC1020032AFM	Inner Clutch Cover Gasket	\$26.18	11482-35G10	
		MR043	Water Pump Cover O-Ring	\$10.09	17431-35G10	
Oil Seal Kit	List Price	Component Part#	Component Description	List Price #	OEM Part #	
C3102OS	\$51.46	OS370	Inner WP Seal	\$10.11	09282-12012	
		OS218	Shift Shaft Seal 14x22x6	\$4.74	09283-14006	
		OS249	Start Shaft Seal	\$3.83	09283-20031	
		OS132	Right Crank Seal	\$16.64	09283-30061	
		OS219	Clutch Actuator Seal	\$2.69	09285-10004	
		OS338	Output Shaft Seal	\$7.90	09289-31002	
		OS216	Impeller Seal	\$5.54	17461-37F00	
		OS371	Decomp. Shaft Seal 10x17x6	\$4.74	09282-10014	
Clutch & Mag Kit	List Price	Component Part#	Component Description	List Price	OEM Part #	
C3102CM	\$27.55	EC1018032AFM	Outer Clutch Cover Gasket	\$17.38	11484-35G10	
		EC1019032AFM	Mag Cover Gasket	\$10.17	11483-35G10	

All Component Parts can be purchased individually.

**WARNING:** Cancer and Reproductive Harm [www.P65Warnings.ca.gov](http://www.P65Warnings.ca.gov)



# MX/Dirt · Off-Road Gaskets



Cometic Gasket - An Exclusive NASCAR Performance® Product

## SUZUKI RM-Z450

Model	Year	Bore Size	EST	List Price	Component Part#	Component Description	List Price	OEM Part #
RM-Z450	08-19	97mm 99mm 101mm	Top End Kit					
			C3233-EST	\$73.48	H2784027S	97mm Bore Head Gasket	\$31.99	11141-28H00
			C3234-EST	\$73.48	H2784SP1027S	99mm Bore Head Gasket	\$31.99	
			C3235-EST	\$73.48	H2784SP2027S	101mm Bore Head Gasket	\$31.99	

Bottom End Kit w/Oil Seals		List Price	Component Part#	Component Description	List Price #	OEM Part #
C3233BE	\$132.75	R116B	Fill Plug O-Ring	\$1.13	09280-17003	
		R22X2V	Sprocket Spacer O-ring 1.9,ID:21.8	\$2.66	09280-21010	
		R22X2V	Crank End Plug O-ring	\$2.66	09280-22008	
		WA116	Drain Plug Gasket	\$1.06	09168-08016	
		R029B	Oil Filter Cover O-ring D:2.0, ID:38.5	\$1.13	09280-39001	
		R16X2V	Oil Screen O-ring 16x22x2	\$3.02	09168-16003	
		WP470	Water Pump Cover O-Ring	\$10.27	17431-28H00	
		R122V	Neutral Safety Switch O-ring	\$1.25	09280-26005	
		R9X2V	Oil Pump Dowel O-ring	\$1.59	09280-09005	
		R007V	Oil Pump Nozzle O-ring 4x1.2	\$0.63	09280-05007	
		EC1250020RC	Center Case Gasket	\$22.66	11481-28H00	
		EC1251032AFM	Inner Clutch Cover Gasket	\$21.53	11482-28H00	

Oil Seal Kit	List Price	Component Part#	Component Description	List Price #	OEM Part #
C3233OS	\$58.95	OS132	Right Crank Seal 30x40x7	\$16.64	09283-30061
		OS216	Water Pump Oil seal	\$5.54	17461-37F00
		OS338	Output Shaft Oil Seal 31x4	\$7.90	09289-31003
		OS249	Start Shaft Oil Seal 20x27x5	\$3.83	09283-20031
		OS305	Shift Shaft Seal 14x22x6	\$5.77	09283-14006
		OS370	Water Pump Seal	\$10.11	09282-12012
		OS372	Left Crank Seal 32x47x6	\$13.89	09283-32037

Clutch & Mag Kit	List Price	Component Part#	Component Description	List Price	OEM Part #
C3233CM	\$26.58	EC1249032AFM	Clutch Cover Gasket	\$14.71	11484-28H00
		EC1252032AFM	Mag Cover Gasket	\$11.87	11483-28H00

Model	Year	Bore Size	Top End Kit	List Price	Component Part#	Component Description	List Price	OEM Part #
DR650	95-15	103 mm	C7335	\$29.35	H0460043F	Head Gasket	\$30.95	11141-12D00
					B0273020F	Base Gasket	\$6.25	11241-32E00

## YAMAHA PW50

Model	Year	Bore Size	Top End Kit	List Price	Component Part#	Component Description	List Price	OEM Part #
PW50	81-05	42 mm	C7266	\$21.99	H0309010C	Head Gasket	\$17.15	517-11181-01-00
					B0185018AFM	Base Gasket	\$4.65	3PT-11351-00
YSR50	87-92	46 mm	C7075	\$21.99	H0057010C	Head Gasket	\$17.15	5G6-11181-00-00
					B0057018AFM	Base Gasket	\$5.05	3T2-11351-00-00

## YAMAHA YZ65

Model	Year	Bore Size	Top End Kit	List Price	Component Part#	Component Description	List Price	OEM Part #
YZ65	18-19	O-ring	C3694	\$31.99	R032V	Inner Head O-ring	\$2.99	93210-50582-00
					R041V	Outer Head O-ring	\$5.30	93210-76MF8-00
					PV160018AFM	Right Power Valve Cover Gasket	\$3.80	BR8-11993-00-00
					PV159018AFM	Front Power Valve Gasket	\$3.80	BR8-11354-00-00
					B1427020F	Base Gasket	\$5.34	BR8-11351-00-00
					R38X3V	Exhaust Gasket	\$3.79	BR8-14642-00-00
			Oil Seal Kit	List Price	Component Part#	Component Description	List Price #	OEM Part #
			C3694OS	\$46.99	OS231	Power Valve Shaft Seal	\$4.86	93104-08040-00
					OS286	Clutch Actuator Seal	\$4.29	93102-12224-00
					OS110	Crank Seals	\$9.47	93102-20485-00
					OS354	Shift Shaft Seal	\$4.46	93101-12173-00
					OS232	Start Shaft Seal	\$4.46	93102-17263-00
					OS231	Power Valve Shaft Seal	\$4.86	93104-08040-00
					OS358	Output Shaft Seal	\$5.94	93102-26042-00
					OS242	Impeller Shaft Seal	\$4.34	93109-11073-00

All Component Parts can be purchased individually.



**WARNING:** Cancer and Reproductive Harm www.P65Warnings.ca.gov





# MX/Dirt • Off-Road Gaskets



Cometic Gasket - An Exclusive NASCAR Performance® Product

## YAMAHA PW80

Model	Year	Bore Size	Top End Kit	List Price	Component Part#	Component Description	List Price	OEM Part #
PW80	83-01	50 mm	C7251	\$26.46	H0310010C	Head Gasket	\$17.15	1W7-11181-00-00
					B0186018AFM	Base Gasket	\$4.65	4AW-11351-00
YZ80	84	50 mm	Top End Kit C7106	List Price \$19.14	Component Part# H0059043F	Component Description Head Gasket	List Price \$14.87	OEM Part # 58T-11181-01-00
					B0058020F	Base Gasket	\$4.65	4VD-11351-00-00
			Crank Seal Kit C7666	List Price \$11.70	Component Part# OS116	Component Description Right Crank Seal 27X40X8	List Price \$7.10	OEM Part # 93103-28011
					OS115	Left Crank Seal 19X40X8	\$5.91	93102-20447
YZ80 N	85	50 mm	Top End Kit C7076	List Price \$22.99	Component Part# H0059043F	Component Description Head Gasket	List Price \$14.87	OEM Part # 58T-11181-01-00
					B0058020F	Base Gasket	\$4.65	4VD-11351-00-00
					IR014018AFM	Intake Gasket	\$3.80	1LR-13621-00-00
			Crank Seal Kit C7666	List Price \$11.70	Component Part# OS116	Component Description Right Crank Seal 27X40X8	List Price \$7.10	OEM Part # 93103-28011
					OS115	Left Crank Seal 19X40X8	\$5.91	93102-20447
YZ80 KR, Z,HF,V, W,B	86-92	50 mm	Top End Kit C7080	List Price \$22.99	Component Part# H0060043F	Component Description Head Gasket	List Price \$14.87	OEM Part # 1LR-11181-01-00
					B0058020F	Base Gasket	\$4.65	4VD-11351-00-00
					IR014018AFM	Intake Gasket	\$3.80	1LR-13621
					R127V	Exhaust O-ring	\$3.92	93210-40745-00
			Crank Seal Kit C7666	List Price \$11.70	Component Part# OS116	Component Description Right Crank Seal 27X40X8	List Price \$7.10	OEM Part # 93103-28011
					OS115	Left Crank Seal 19X40X8	\$5.91	93102-20447
YZ80	93-01	O-Ring 54 mm Big Bore	Top End Kit C7137	List Price \$22.99	Component Part# R85X2V	Component Description Outer Head O-ring	List Price \$7.14	OEM Part # 93210-84724-00
			C7331	\$22.99	R55X2V	Inner Head O-ring	\$2.34	93210-56459-00
					H0303043F	54mm Big Bore Head Gasket	\$17.38	
					B0120018AFM	Base Gasket	\$12.39	4ES-11351-00-00
					B0120012F	High Comp. Base Gasket .012"	\$5.34	
					R127V	Exhaust O-ring	\$3.92	5PA-14642-00-00

Bottom End Kit w/Oil Seals	List Price	Component Part#	Component Description	List Price #	OEM Part #
C7137BE	\$57.55	WP054018AFM	Water Pump Gasket	\$12.39	4BA-12428-00-00
		WA118	Water Pump Drain Plug	\$1.88	90430-06166-00
		WA116	Case Drain Crush Washer	\$3.02	90430-08119-00
		R116B	Fill Plug O-ring	\$1.13	93210-19123-00
Oil Seal Kit	List Price	Component Part#	Component Description	List Price #	OEM Part #
C7137OS	\$46.55	OS354	Shift Shaft Seal 11.5X21X4	\$4.46	93101-12173-00
Crank Seal Kit	List Price	OS286	Clutch Pushrod Oil seal 12x18x5	\$4.29	93102-12224-00
C7666	\$11.70	OS232	Start Shaft Seal 17x25x4	\$4.46	93102-17263-00
		OS225	Output Shaft Seal 20X30X5	\$5.03	93102-20143-00
		OS173	Left Crank Seal 27x40x8	\$8.29	93102-20447-00
		OS115	Right Crank Seal 19Xx40x8	\$5.91	93103-28126-00
		OS226	Water Pump Oil Seal	\$14.11	93103-10147-00
			10x31x13.5		/93103-10168-00
Clutch & Mag Kit	List Price	Component Part#	Component Description	List Price	OEM Part #
C7137CM	\$21.30	C7500	Clutch Cover	\$8.69	4ES-15461-00-00
		EC219060AFM	Mag Cover	\$12.39	4ES-15451-00-00

All Component Parts can be purchased individually.

**WARNING:** Cancer and Reproductive Harm [www.P65Warnings.ca.gov](http://www.P65Warnings.ca.gov)



# MX/Dirt • Off-Road Gaskets



Cometic Gasket - An Exclusive NASCAR Performance® Product

## YAMAHA YZ85

Model	Year	Bore Size	Top End Kit	List Price	Component Part#	Component Description	List Price	OEM Part #
YZ85	02-18	O-Ring	C7851	\$25.55	R85X2V	Outer Head O-ring	\$7.14	93210-84724-00
					R57X2V	Inner Head O-ring	\$3.20	93210-56459-00
					B0120018AFM	Base Gasket	\$12.39	4ES-11351-00-00
					B0120012F	High Comp. Base Gasket .012"	\$5.34	
					R127V	Exhaust O-ring 2 Req.	\$3.92	5PA-14642-00-00
		<b>Bottom End Kit w/Oil Seals</b>	<b>List Price</b>	<b>Component Part#</b>	<b>Component Description</b>	<b>List Price #</b>	<b>OEM Part #</b>	
		C7851BE	\$57.55	WP054020F	Water Pump Gasket	\$12.39	4BA-12428-00-00	
				EC220020F	Inner Clutch Cover	\$8.69	4ES-15461-00-00	
				WA116	Drain Plug Gasket	\$3.02	90430-08119-00	
				R117B	Fill Plug O-ring	\$0.42	93210-19123-00	
		<b>Oil Seal Kit</b>	<b>List Price</b>	<b>Component Part#</b>	<b>Component Description</b>	<b>List Price #</b>	<b>OEM Part #</b>	
		C7851OS	\$40.36	OS354	Shift Shaft Seal 11.5X21X4	\$4.46	93101-12173-00	
		<b>Crank Seal Kit</b>	<b>List Price</b>	<b>Component Part#</b>	<b>Component Description</b>	<b>List Price #</b>	<b>OEM Part #</b>	
		C7666	\$11.70	OS286	Clutch Pushrod Oil seal 12x18x5	\$4.29	93102-12224-00	
				OS227	Water Pump Seal 12x22x5	\$2.67	93102-12321-00	
				OS232	Start Shaft Seal 17x25x4	\$4.46	93102-17263-00	
				OS173	Left Crank Seal 27x40x8	\$8.29	93102-20447-00	
				OS358	Output Shaft Seal 26X38X5	\$5.94	93102-26042-00	
				OS115	Right Crank Seal 19Xx40x8	\$5.91	93102-28009-00	
				OS283	Impeller Seal 11x25x7	\$4.34	93109-11073-00	
		<b>Clutch &amp; Mag Kit</b>	<b>List Price</b>	<b>Component Part#</b>	<b>Component Description</b>	<b>List Price</b>	<b>OEM Part #</b>	
		C7851CM	\$18.16	EC640060AFM	Mag Cover Gasket	\$9.47	5PA-15451-00-00	
				EC632018AFM	Outer Clutch Cover Gasket	\$8.69	93210-12152-00	

Model	Year	Bore Size	Top End Kit	List Price	Component Part#	Component Description	List Price	OEM Part #
YZ85	2019	O-Ring	C3731	\$31.99	R55X2V	Inner Cylinder Head O-Ring	\$2.34	93210-56459-00
					R85X2V	Outer Cylinder Head O-ring	\$7.14	93210-84724-00
					PV164	Right Power Valve Cover Gasket	\$3.80	B4B-11993-00-00
					PV163	Front Power Valve Cover Gasket	\$3.80	1C3-11354-00-00
					B1438018AFM	Cylinder Base Gasket	\$5.34	B4B-11351-00-00
					WA136	Cylinder Head Crush Washer	\$1.31	90201-080L8-00
					OS231	Power Valve Axle Oil Seal	\$4.86	93104-08040-00
					R127V	Exhaust O-rings	\$3.92	93210-40745-00
		<b>Bottom End Kit</b>	<b>List Price</b>	<b>Component Part#</b>	<b>Component Description</b>	<b>List Price #</b>	<b>OEM Part #</b>	
		C3731BE	\$73.99	WA118	Water Pump Crush Washer	\$1.88	90430-06166-00	
				WP638018AFM	Water Pump Cover Gasket	\$12.39	BR8-12428-00-00	
				EC2450018AFM	Primary Cover Gasket	\$8.69	BR8-15461-00-00	
				R19X2V	Fill Plug O-ring	\$2.50	93210-19123-00	
				WA116	Drain Plug Crush Washer	\$1.06	90430-08119-00	
		<b>Oil Seal Kit</b>	<b>List Price</b>	<b>Component Part#</b>	<b>Component Description</b>	<b>List Price #</b>	<b>OEM Part #</b>	
		C3694OS	\$46.99	OS110	Crank Seals	\$9.47	93102-20485-00	
				OS227	Primary Cover Seal (WP)	\$2.67	93102-12106-00	
				OS231	Power Valve Actuator Oil Seal	\$4.86	93104-08040-00	
				OS232	Start Shaft Seal	\$4.46	93102-17263-00	
				OS242	Impeller Shaft Seal	\$5.06	93109-11073-00	
				OS286	Clutch Lifter Oil Seal	\$4.29	93102-12224-00	
				OS354	Shift Shaft Seal	\$4.46	93101-12173-00	
				OS358	Output Shaft Seal	\$5.94	93102-26042-00	
		<b>Clutch &amp; Mag Kit</b>	<b>List Price</b>	<b>Component Part#</b>	<b>Component Description</b>	<b>List Price</b>	<b>OEM Part #</b>	
		C7851CM	\$18.16	EC640060AFM	Outer Clutch Cover Gasket	\$8.69	5PA-15463-00-00	
				EC2449032AFM	Mag Cover Gasket	\$9.47	5PA-15451-00-00	

All Component Parts can be purchased individually.



**WARNING:** Cancer and Reproductive Harm [www.P65Warnings.ca.gov](http://www.P65Warnings.ca.gov)



# MX/Dirt • Off-Road Gaskets



Cometic Gasket - An Exclusive NASCAR Performance® Product

## YAMAHA TT-R90



Model	Year	Bore Size	Top End Kit	List Price
TT-R90	00-08	48mm	C3249-EST	\$54.99

Component Part#	Component Description	List Price	OEM Part #
H2813SP1043F	Head Gasket	\$18.56	4GL-11181-00-00
B0956010RC	Base Gasket	\$6.25	5HN-11351-00-00
EC1286018AFM	Cam Chain Tensioner	\$2.04	90430-06014-00
3179V	Valve Seals 2 Req.	\$5.50 ea.	1WG-12119-00-00
R013V	Valve Guide O-ring 2 Req.	\$1.08	93210-09418-00
R133B	Valve Cover O-rings 2 Req.	\$1.13	93210-44704-00
WA114	Cam Chain Washer 2 Req.	\$3.02	90430-06014-00
R62X2V	Cam Gear Cover	\$4.64	93210-63556-00

## YAMAHA YZ125

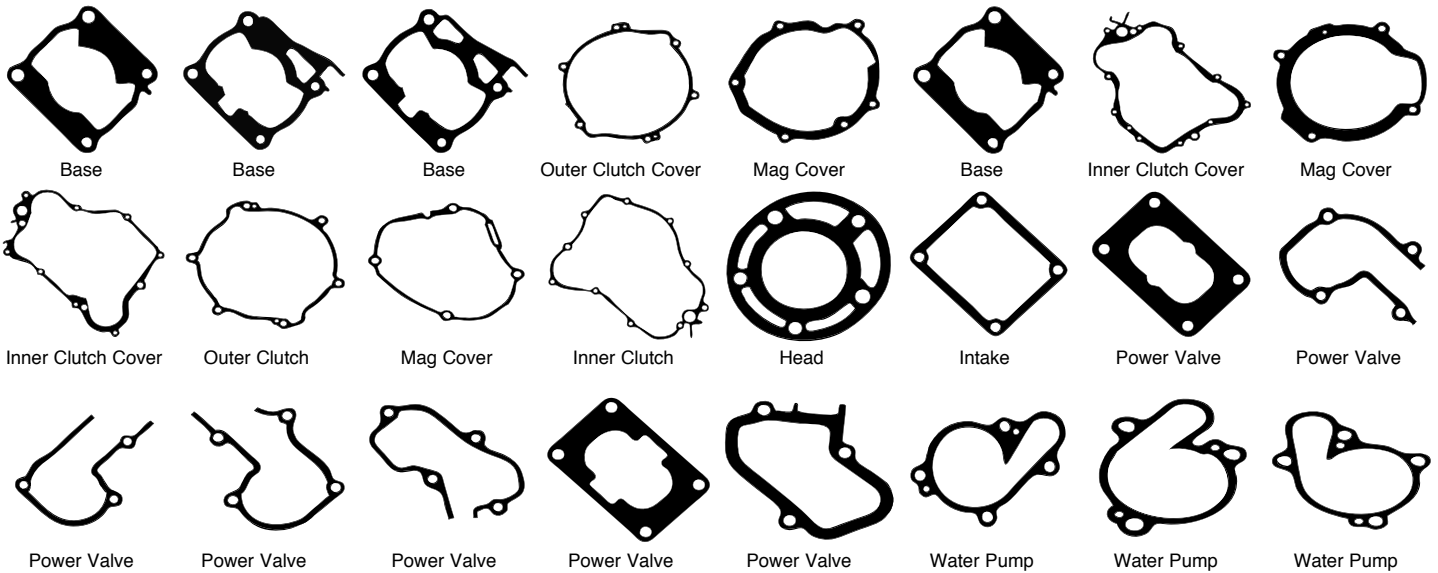

Model	Year	Bore Size	Top End Kit	List Price	Component Part#	Component Description	List Price	OEM Part #
YZ125	83-84	58 mm	C7107	\$22.99	H0061043F	Head Gasket	\$17.38	55Y-11181-01-00
					B0059020F	Base Gasket	\$5.34	24X-11351-00-00
YZ125 N	85	58 mm	C7081	\$31.91	H0061043F	Head Gasket	\$17.38	55Y-11181-01-00
					B0059020F	Base Gasket	\$5.34	24X-11351-00-00
					IR015020F	Intake Gasket	\$3.80	39W-13621-01-00
					PV029020F	Right Side Power Valve Cover	\$3.80	5X4-1131N-00-00
					PV030020F	Left Side Power Valve Gasket	\$3.80	5X4-11993-00-00
YZ125 S, T, J	86-88	O-Ring	C7082	\$31.91	R105X2B	Outer Head O-ring	\$2.57	93211-07720-00
					R63X2V	Inner Head O-ring	\$4.57	93210-65721-00
					B0060020F	Base Gasket	\$5.34	1LX-11351-00-00
					PV035020F	Right Side Power Valve Gasket	\$3.80	2VM-11993-00-00
					PV029020F	Left Side Power Valve Cover	\$3.80	5X4-1131N-00-00
					IR016020F	Intake Gasket	\$3.80	3XP-13621-00-00
			Crank Seal Kit	List Price	Component Part#	Component Description	List Price	OEM Part #
			C7668	\$19.21	OS118	Left Crank Seal 21X40X7	\$7.10	93102-22363-00
					OS123	Right Crank Seal 30X44X8	\$14.25	93103-32171-00

All Component Parts can be purchased individually.

**WARNING:** Cancer and Reproductive Harm [www.P65Warnings.ca.gov](http://www.P65Warnings.ca.gov)



# MX/Dirt • Off-Road Gaskets



Cometic Gasket - An Exclusive NASCAR Performance® Product

## YAMAHA YZ125 W

Model	Year	Bore Size	Top End Kit	List Price	Component Part#	Component Description	List Price	OEM Part #						
YZ125 W	89	O-Ring	C7083	\$31.91	R105X2B	Outer Head O-ring	\$2.57	93211-07720-00						
					R63X2V	Inner Head O-ring	\$4.57	93210-65721-00						
					B0060020F	Base Gasket	\$5.34	1LX-11351-00-00						
					IR017020F	Intake Gasket	\$3.80	80L-13621-01-00						
					PV035020F	Right Side Power Valve Gasket	\$3.80	2VM-11993-00-00						
					PV029020F	Left Side Power Valve Cover	\$3.80	5X4-1131N-00-00						
					Crank Seal Kit C7668	List Price \$19.21	Component Part#	Component Description	List Price	OEM Part #				
											OS118	Left Crank Seal 21X40X7	\$7.10	93102-22363-00
											OS123	Right Crank Seal 30X44X8	\$14.25	93103-32171-00
											Component Part#	Component Description	List Price #	OEM Part #
C7481	Clutch Cover	\$6.48	3JD-15463-10-00											
YZ125	90-91	O-Ring	C7084	\$30.66	R105X2B	Outer Head O-ring	\$2.57	93211-07720-00						
					R63X2V	Inner Head O-ring	\$4.57	93210-65721-00						
					B0060020F	Base Gasket	\$5.34	1LX-11351-00-00						
					IR017020F	Intake Gasket	\$3.80	80L-13621-01-00						
					PV035020F	Right Side Power Valve Gasket	\$3.80	2VM-11993-00-00						
					PV029020F	Left Side Power Valve Cover	\$3.80	5X4-1131N-00-00						
					Crank Seal Kit C7668	List Price \$19.21	Component Part#	Component Description	List Price	OEM Part #				
											OS118	Left Crank Seal 21X40X7	\$7.10	93102-22363-00
											OS123	Right Crank Seal 30X44X8	\$14.25	93103-32171-00
											Component Part#	Component Description	List Price	OEM Part #
C7481	Clutch Cover	\$6.48	3JD-15463-10-00											
YZ125	92-93	O-Ring	C7139	\$30.66	R105X2B	Outer Head O-ring	\$2.57	93211-07720-00						
					R63X2V	Inner Head O-ring	\$4.57	93210-65721-00						
					B0060020F	Base Gasket	\$5.34	1LX-11351-00-00						
					R221V	Exhaust O-ring	\$3.92	93210-45742-00						
					IR017020F	Intake Gasket	\$3.80	80L-13621-01-00						
					PV033020F	Right Side Power Valve Gasket	\$3.80	4DB-11993-01-00						
					PV032020F	Left Side Power Valve Gasket	\$3.80	4DB-1131N-00-00						
					Bottom End Kit w/crank seals C3294	List Price \$37.52	Component Part#	Component Description	List Price	OEM Part #				
											EC284020F	Inner Clutch Gasket	\$8.29	1LX-15462-10
											EC283020F	Mag Cover Gasket	\$6.25	4DB-15451-00
C7481	Clutch Cover	\$6.48	3JD-15463-10											
Crank Seal Kit C7668	List Price \$19.21	Component Part#	Component Description	List Price	OEM Part #									
						WP060020F	Water Pump Gasket	\$4.54	1LX-12428-01					
YZ125	94-97	O-Ring	C7158	\$30.66	R90X2B	Outer Head O-ring	\$2.86	93210-90785-00						
					R63X2V	Inner Head O-ring	\$4.57	93210-63442-00						
					B0153018AFM	Base Gasket	\$7.10	4JY-11351-00						
					B0153012F	Base Gasket High Comp. 012"	\$9.32	4JY-11351-00						
					R223V	Exhaust O-ring 2 Req.	\$3.92	93210-42728-00						
					PV059018AFM	Front Power Valve Gasket	\$3.80	4JY-11354-00						
					PV041018AFM	Right Power Valve Gasket	\$3.80	4JY-11993-00-00						
					Bottom End Kit w/crank seals C3295	List Price \$37.52	Component Part#	Component Description	List Price	OEM Part #				
											EC268032AFM	Inner Clutch Cover Gasket	\$8.29	4JY-15462-00
											EC224018AFM	Mag Cover Gasket	\$6.25	4JY-15451-00
C7489	Clutch Cover	\$6.48	4JY-15463-00											
Clutch & Mag Kit C7158CM	List Price \$12.73	Component Part#	Component Description	List Price	OEM Part #									
						WP043018AFM	Water Pump Gasket	\$4.54	4JY-12428-00					
Crank Seal Kit C7705	List Price \$25.55	Component Part#	Component Description	List Price	OEM Part #									
						C7489	Clutch Cover Gasket	\$6.48	4JY-15463-01-00					
						EC219060AFM	Mag Cover Gasket	\$12.39	4ES-15451-00					
Crank Seal Kit C7705	List Price \$25.55	Component Part#	Component Description	List Price	OEM Part #									
						OS118	Left Crank Seal 21X40X7	\$7.10	93102-22363-00					
					OS123	Right Crank Seal 30X44X8	\$14.25	93103-32171-00						

All Component Parts can be purchased individually.



**WARNING:** Cancer and Reproductive Harm [www.P65Warnings.ca.gov](http://www.P65Warnings.ca.gov)



# MX/Dirt • Off-Road Gaskets



Cometic Gasket - An Exclusive NASCAR Performance® Product

## YAMAHA YZ125

Model	Year	Bore Size	Top End Kit	List Price	Component Part#	Component Description	List Price	OEM Part #
YZ125	98-00	O-Ring	C7399	\$30.66	R90X2B	Outer Head O-ring	\$2.86	93210-90785-00
					R63X2V	Inner Head O-ring	\$4.57	93210-63442-00
					B0318018AFM	Base Gasket	\$7.49	5DH-11351-01-00
					B0318012F	High Compression Base Gasket	\$9.32	5DH-11351-01-00
					PV059018AFM	Front Power Valve Cover Gasket	\$3.80	4JY-11354-00
					PV041018AFM	Right Side Power Valve Gasket	\$3.80	4JY-11993-00
					R224V	Exhaust O-rings 98-00 2 Req.	\$1.19	93210-45742-00
					R223V	Exhaust O-rings 2001 2 Req.	\$3.92	5MV-14642-00-00

Bottom End Kit w/Oil Seals	List Price	Component Part#	Component Description	List Price #	OEM Part #
C7399BE	\$62.77	EC268032AFM	Inner Clutch Gasket	\$8.29	4JY-15462-00
		WP043018AFM	Water Pump Gasket	\$4.54	4JY-12428-00
		R018V	Case Dowel Pin O-ring	\$1.19	93210-16314-00
		WA114	Drain Plug Gasket	\$3.02	90430-12207-00
		R19X2V	Fill Plug O-ring	\$2.50	93210-19123-00
Oil Seal Kit	List Price	Component Part#	Component Description	List Price #	OEM Part #
C7399OS	\$48.46	OS117	Right Side Crank Seal	7.10	93103-32183-00
Crank Seal Kit	List Price	Component Part#	Component Description	List Price #	OEM Part #
C7667	\$12.78	OS118	Left Side Crank Seal	\$7.10	93102-22363-00
		OS227	Inner Water Pump Oil Seal 12x22x5	\$2.67	93102-12321-00
		OS228	Shift Shaft Seal 12x19x5	\$4.51	93109-12012-00
		OS231	Power Valve Shaft Oil Seal 8x12x3	\$4.86	93104-08040-00
		OS232	Starter Shaft Seal 17x25x4	\$4.46	93102-17263-00
		OS242	Water Pump Oil Seal 12x25x7	\$2.67	93109-11073-00
		OS286	Clutch Pushrod Oil Seal 12x18x5	\$4.29	93102-12224-00
		OS358	Output Shaft Seal 28x38x5	\$5.94	93102-26042-00
Clutch & Mag Kit	List Price	Component Part#	Component Description	List Price	OEM Part #
C7158CM	\$12.73	C7489	Clutch Cover Gasket	\$6.48	4JY-15463-01-00
		EC219060AFM	Mag Cover Gasket	\$12.39	4ES-15451-00

Model	Year	Bore Size	Top End Kit	List Price	Component Part#	Component Description	List Price	OEM Part #
YZ125	01-02	O-Ring	C7853	\$33.17	R90X2B	Outer Head O-ring	\$2.86	93210-90785-00
					R63X2V	Inner Head O-ring	\$4.57	93210-63442-00
					B0318018AFM	Base Gasket	\$7.49	5DH-11351-01-00
					B0318012F	High Compression Base Gasket	\$9.32	5DH-11351-01-00
					PV059018AFM	Front Power Valve Cover Gasket	\$3.80	4JY-11354-00
					PV041018AFM	Right Side Power Valve Gasket	\$3.80	4JY-11993-00
					R223V	Exhaust O-rings 2001 2 Req.	\$3.92	5MV-14642-00-00

Model	Year	Bore Size	Top End Kit	List Price	Component Part#	Component Description	List Price	OEM Part #
YZ125	03-04	O-Ring	C7936	\$33.17	R90X2B	Outer Head O-ring	\$2.86	93210-90785-00
					R63X2V	Inner Head O-ring	\$4.57	93210-63442-00
					B0318032AFM	Base Gasket	\$7.49	5DH-11351-01-00
					B0318012F	High Compression Base Gasket	\$9.32	5DH-11351-01-00
					PV114018AFM	Front Power Valve Gasket	\$3.80	4JY-11993-00
					PV041018AFM	Right Side Power Valve Gasket	\$3.80	4JY-11993-00
					R223V	Exhaust O-rings 2001 2 Req.	\$3.92	5MV-14642-00-00

Model	Year	Bore Size	Bottom End Kit w/Oil Seals	List Price	Component Part#	Component Description	List Price #	OEM Part #
YZ125	01-04	O-Ring	C7853BE	\$64.13	R018V	Case O-ring	\$2.90	93210-16314-00
					WA114	Drain Plug Gasket	\$2.90	90430-12207-00
					EC268020F	Inner Clutch Cover Gasket	\$17.15	4JY-15462-00-00
					R19X2V	Trans Fill Plug O-ring	\$2.40	93210-19123-00
					WA114	Clutch Drain Plug Gasket	\$2.90	90430-06014-00
					WP043018AFM	Water Pump Cover Gasket	\$4.54	4JY-12428-10-00
Oil Seal Kit	List Price	Component Part#	Component Description	List Price #	OEM Part #			
C7853OS	\$56.26	OS110	Left Crank Seal	\$9.47	93102-20485-00			
		OS182	Right Crank Seal	\$11.87	93102-30008-00			
		OS227	Water Pump Shaft Seal	\$5.21	93102-12321-00			
		OS228	Shift Shaft Seal	\$3.62	93109-12012-00			
		OS231	PV Governor Oil Seal	\$5.19	93104-08040-00			
		OS232	Kickstart Shaft Seal	\$5.14	93102-17263-00			
		OS242	Impeller Seal	\$4.34	93109-11073-00			
		OS286	Clutch Pushrod Seal	\$5.48	93102-12224-00			
		OS358	Output Shaft Seal	\$5.94	93102-26042-00			
Clutch & Mag Kit	List Price	Component Part#	Component Description	List Price	OEM Part #			
C7158CM	\$12.73	C7489	Clutch Cover Gasket	\$6.48	4JY-15463-01-00			
		EC219060AFM	Mag Cover Gasket	\$12.39	4ES-15451-00			



**WARNING:** Cancer and Reproductive Harm [www.P65Warnings.ca.gov](http://www.P65Warnings.ca.gov)





# MX/Dirt • Off-Road Gaskets



Cometic Gasket - An Exclusive NASCAR Performance® Product

## YAMAHA YZ125

Model	Year	Bore Size	Top End Kit	List Price	Component Part#	Component Description	List Price	OEM Part #
YZ125	05-19	O-Ring	C3105	\$33.17	R90X2B	Outer Head O-ring	\$2.86	93210-90785-00
					R63X2V	Inner Head O-ring	\$4.57	93210-63442-00
					B0749032AFM	Base Gasket	\$7.49	1C3-11351-00-00
					B0749018AFM	Base Gasket	\$7.49	1C3-11351-00-00
					R223V	Exhaust O-rings 2001 2 Req.	\$3.92	5MV-14642-00-00
					PV131018AFM	Right Side Power Valve Cover	\$3.80	1C3-11993-00-00
					PV114018AFM	Front Power Valve Gasket	\$3.80	4JY-11354-10-00
					WA136	Head Crush Washers 5 Req.	\$1.31	90201-080L8-00

Bottom End Kit w/Oil Seals	List Price	Component Part#	Component Description	List Price #	OEM Part #
C3105BE	\$69.95	EC1006018AFM	Primary (Inner Clutch) Cover	17.84	1C3-15462-00-00
		R018V	Crankcase Dowel O-ring	\$1.19	93210-16314-00
		R116B	Fill Plug O-ring	\$1.13	93210-19123-00
		WA082063C	Drain Plug Gasket	\$1.93	90430-10188-00
		WA114	Clutch Cover Drain Plug Washer	\$3.02	90430-06014-00
		WP177032AFM	Water Pump Gasket	\$4.72	1C3-12428-00-00

  

Oil Seal Kit	List Price	Component Part#	Component Description	List Price #	OEM Part #
C3105OS	\$39.01	OS110	Left Crank Seal	\$9.47	93102-20485-00
		OS229	Clutch Pushrod Seal	\$1.99	93102-10008-00
		OS232	Kickstart Shaft Seal	\$4.46	93102-17263-00
		OS233	Inner Water Pump Seal	\$3.62	93102-08307-00
		OS235	Output Shaft Seal	\$1.99	93102-28012-00
		OS308	Outer Water Pump Seal	\$5.89	93102-08004-00
		OS286	Shift Shaft Seal	\$4.29	93102-12224-00
		OS234	Right Crank Seal	\$4.61	93102-22419-00
		OS230	Inner Shift Shaft Seal	\$2.69	93104-12003-00

Clutch & Mag Kit	List Price	Component Part#	Component Description	List Price	OEM Part #
C3105CM	\$18.23	EC927032AFM	Clutch Cover Gasket	\$9.94	1C3-15463-00
		EC1005018AFM	Mag Cover Gasket	\$8.29	1C3-15451-00

## YAMAHA TT125

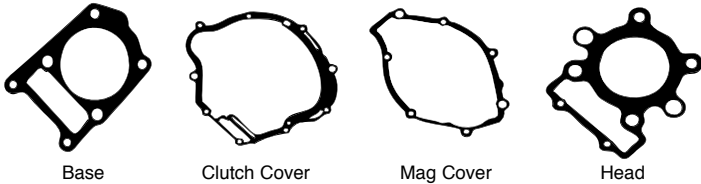

Model	Year	Bore Size	Top End Kit	List Price	Component Part#	Component Description	List Price	OEM Part #
TTR125	99-05	55 mm	C7755	\$28.11	H1014010S	Head Gasket	\$11.18	5AP-11181-00
		58 mm	C7815	\$28.11	H1014SP1010S	Head Gasket 58mm Bore	\$11.18	5AP-11181-00
					B0478020F	Base Gasket	\$3.12	5HP-11351-00
					R70X2S	Base O-ring	\$3.21	93210-57897-00
					R140V	Cam Cover O-ring	\$3.29	93210-71462-00
			Bottom End Kit	List Price	Component Part#	Component Description	List Price	OEM Part #
			C3299	\$11.99	EC471020F	Mag Cover Gasket	\$7.12	5HP-15451-00
					EC470020F	Clutch Cover Gasket	\$6.71	5HP-15461-00
					R132V	Tappet Cover O-ring 2 Req	\$1.19	93210-44704-00

## YAMAHA DT/WR200

Model	Year	Bore Size	Top End Kit	List Price	Component Part#	Component Description	List Price	OEM Part #
DT/WR200	90-92	68 mm	C7142	\$26.29	H0178043F	Head Gasket	\$19.82	4TP-11181-00-00
		72 mm	C7330	\$26.29	H0450043F	Head Gasket 72mm	\$19.82	
					B0135020F	Base Gasket	\$6.25	4TP-11351-00-00



# MX/Dirt • Off-Road Gaskets



Cometic Gasket - An Exclusive NASCAR Performance® Product

## YAMAHA YZ250

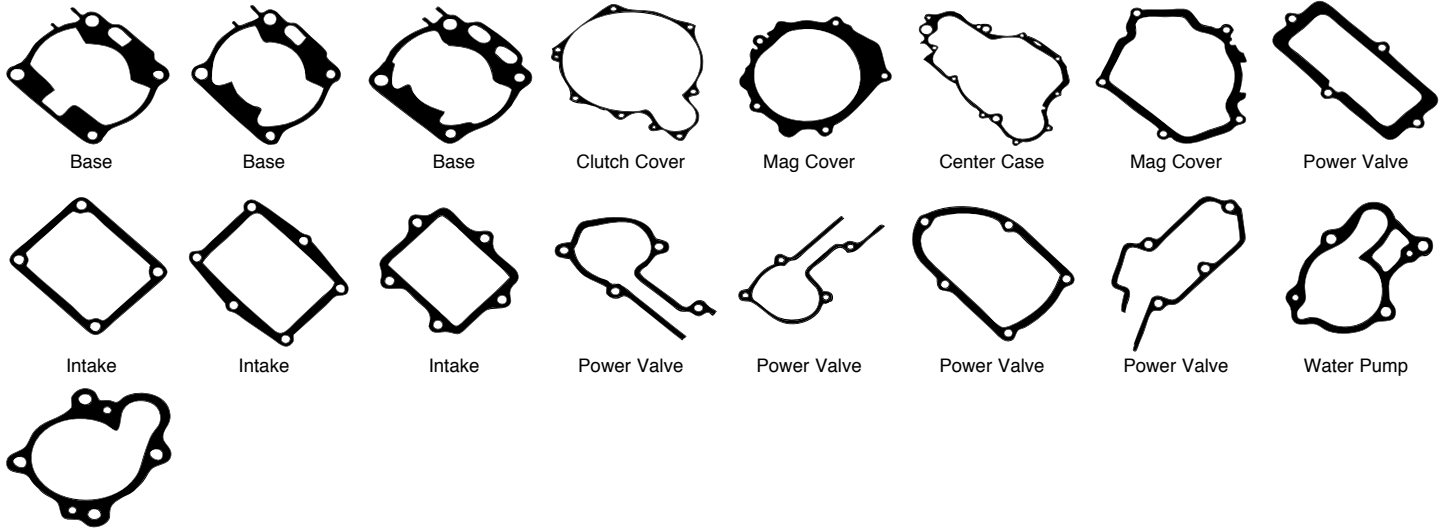

Model	Year	Bore Size	Top End Kit	List Price	Component Part#	Component Description	List Price	OEM Part #
YZ250	86-87	O-Ring	C7086	\$36.99	R115X2B	Outer Head O-ring	\$2.86	93211-17405-00
					R76X2V	Inner Head O-ring	\$3.64	93210-77363-00
					B0061020F	Base Gasket	\$6.25	1LU-11351-00-00
					IR018018AFM	Intake Gasket	\$3.80	2K7-13621-00-00
					PV034020F	Right Side Power Valve Gasket	\$3.80	1LU-11993-00-00
					PV029020F	Left Side Power Valve Gasket	\$3.80	5X4-1131N-00-00
YZ250	88	O-Ring	C7087	\$36.99	R110X2B	Outer Head O-ring	\$2.86	93211-11770-00
					R76X2V	Inner Head O-ring	\$3.64	93210-77363-00
					B0061020F	Base Gasket	\$6.25	1LU-11351-00-00
					IR018018AFM	Intake Gasket	\$3.80	2K7-13621-00-00
					PV037020F	Right Side Power Valve	\$3.80	2VM-11993-00-00
					PV029020F	Left Side Power Valve Gasket	\$3.80	5X4-1131N-00-00
					R228V	Exhaust O-ring	\$3.92	93210-56743-00
			Crank Seal Kit	List Price	Component Part#	Component Description	List Price	OEM Part #
			C7669	\$12.78	OS118	Left Crank Seal 21X40X7	\$7.10	93102-22363-00
					OS119	Right Crank Seal 34X55X10	\$7.10	93103-40091-00
YZ250	89	O-Ring	C7088	\$35.72	R110X2B	Outer Head O-ring	\$2.86	93211-11770-00
					R76X2V	Inner Head O-ring	\$3.64	93210-77363-00
					B0062018AFM	Base Gasket	\$6.25	2VM-11351-10
					B0062012F	Base Gasket	\$9.32	2VM-11351-10
					PV037020F	Right Side Power Valve	\$3.80	2VM-11993-00-00
					PV036018AFM	Left Side Power Valve	\$3.80	3JE-1131N-10-00
					IR017020F	Intake Gasket	\$3.80	8CH/8DF-13621-00
					R228V	Exhaust O-ring	\$3.92	93210-56743-00
			Crank Seal Kit	List Price	Component Part#	Component Description	List Price	OEM Part #
			C7669	\$12.78	OS118	Left Crank Seal 21X40X7	\$7.10	93102-22363-00
					Component Part#	Component Description	List Price	OEM Part #
					C7488	Clutch Cover	\$7.66	3SP-15463-11-00
YZ250, WR250	90-91 92-94	O-Ring	C7089	\$35.72	R110X2B	Outer Head O-ring	\$2.86	93211-11770-00
					R76X2V	Inner Head O-ring	\$3.64	93210-77363-00
					B0062018AFM	Base Gasket	\$6.25	2VM-11351-10-00
					B0062012F	High Compression Base Gasket	\$9.32	2VM-11351-10-00
					IR017020F	Intake Gasket	\$3.80	8CH/8DF-13621-00
					PV036018AFM	Left Side Power Valve	\$3.80	3JE-1131N-10-00
					PV038018AFM	Right Side Power Valve Gasket	\$3.80	3SP-11993-10-00
					R228V	Exhaust O-ring	\$3.92	93210-56743-00
			Crank Seal Kit	List Price	Component Part#	Component Description	List Price	OEM Part #
			C7669	\$12.78	OS118	Left Crank Seal 21X40X7	\$7.10	93102-22363-00
					OS119	Right Crank Seal 34X55X10	\$7.10	93103-40091-00
					Component Part#	Component Description	List Price	OEM Part #
					C7488	Clutch Cover	\$7.66	3SP-15463-11-00

All Component Parts can be purchased individually.

**WARNING:** Cancer and Reproductive Harm [www.P65Warnings.ca.gov](http://www.P65Warnings.ca.gov)



# MX/Dirt • Off-Road Gaskets



Cometic Gasket - An Exclusive NASCAR Performance® Product

## YAMAHA YZ250

Model	Year	Bore Size	Top End Kit	List Price	Component Part#	Component Description	List Price	OEM Part #		
YZ250	95-96	O-Ring	C7250	\$35.72	R110X2B	Outer Head O-ring	\$2.86	93211-11770-00		
					R76X2V	Inner Head O-ring	\$3.64	93210-77363-00		
					B0062018AFM	Base Gasket	\$6.25	2VM-11351-10-00		
					B0062012F	High Compression Base Gasket	\$9.32	2VM-11351-10-00		
					IR017020F	Intake Gasket	\$3.80	8CH/8DF-13621-00		
					PV036018AFM	Left Side Power Valve	\$3.80	3JE-1131N-10-00		
					PV038018AFM	Right Side Power Valve Gasket	\$3.80	3SP-11993-10-00		
					PV045018AFM	Left side PV	\$3.80	4MX-11354-00		
					R224V	Exhaust O-ring	\$1.19	93210-472A9-00		
					<b>Bottom End Kit w/crank seals</b>	<b>List Price</b>	<b>Component Part#</b>	<b>Component Description</b>	<b>List Price</b>	<b>OEM Part #</b>
					C3300	\$28.50	C7488	Clutch Cover	\$7.66	3SP-15463-11-00
							EC253060AFM	Mag Cover Gasket	\$5.00	2VM-15462-10-00
							EC254020F	Crankcase Gasket	\$5.00	2VM-15462-10-00
							WP044018AFM	Water Pump Gasket	\$3.74	2VM-12428-11-00
					<b>Clutch &amp; Mag Kit</b>	<b>List Price</b>	<b>Component Part#</b>	<b>Component Description</b>	<b>List Price</b>	<b>OEM Part #</b>
C7113CM	\$12.66	C7488	Clutch Cover	\$7.66	3SP-15463-11-00					
		EC253060AFM	Mag Cover Gasket	\$5.00	2VM-15462-10-00					
<b>Crank Seal Kit</b>	<b>List Price</b>	<b>Component Part#</b>	<b>Component Description</b>	<b>List Price</b>	<b>OEM #</b>					
C7669	\$12.78	OS118	Left Crank Seal 21X40X7	\$7.10	93102-22363-00					
		OS119	Right Crank Seal 34X55X10	\$7.10	93103-40091-00					
YZ250	97-98	O-Ring	C7337	\$35.72	R110X2B	Outer Head O-ring	\$2.86	93211-11770-00		
					R76X2V	Inner Head O-ring	\$3.64	93210-77363-00		
					B0272018AFM	Base Gasket .018" AFM	\$6.25			
					B0272012F	High Compression Base Gasket	\$9.32			
					IR017020F	Intake Gasket	\$3.80	8CH/8DF-13621-00		
					R224V	Exhaust O-ring	\$1.19	93210-472A9-00		
					PV036018AFM	Left Side Power Valve	\$3.80	3JE-1131N-10-00		
					PV038018AFM	Right Side Power Valve Gasket	\$3.80	3SP-11993-10-00		
					PV045018AFM	Left side PV	\$3.80	4MX-11354-00		
					<b>Bottom End Kit w/crank seals</b>	<b>List Price</b>	<b>Component Part#</b>	<b>Component Description</b>	<b>List Price</b>	<b>OEM Part #</b>
					C3300	\$28.50	C7488	Clutch Cover	\$7.66	3SP-15463-11-00
							EC253060AFM	Mag Cover Gasket	\$5.00	2VM-15462-10-00
							EC254020F	Crankcase Gasket	\$5.00	2VM-15462-10-00
							WP044018AFM	Water Pump	\$3.74	2VM-12428-11-00
					<b>Clutch &amp; Mag Kit</b>	<b>List Price</b>	<b>Component Part#</b>	<b>Component Description</b>	<b>List Price</b>	<b>OEM Part #</b>
C7113CM	\$12.66	C7488	Clutch Cover	\$7.66	3SP-15463-11-00					
		EC253060AFM	Mag Cover Gasket	\$5.00	2VM-15462-10-00					
<b>Crank Seal Kit</b>	<b>List Price</b>	<b>Component Part#</b>	<b>Component Description</b>	<b>List Price</b>	<b>OEM Part #</b>					
C7669	\$12.78	OS118	Left Crank Seal 21X40X7	\$7.10	93102-22363-00					
		OS119	Right Crank Seal 34X55X10	\$7.10	93103-40091-00					
YZ250	99-01	O-Ring	C7507	\$35.72	R101X2B	Outer Head O-ring	\$2.14	93211-02703-00		
					R73X2V	Inner Head O-ring	\$3.71	93210-74316-00		
					B0372032AFM	Base Gasket	\$7.44	5CU-11351-00		
					B0372012F	High Compression Base Gasket	\$9.94			
					PV082018AFM	Right Side Power Valve Gasket	\$7.44	5CU-11993-00		
					PV083018AFM	Front Power Valve Gasket	\$7.44	5CU-11354-00		
					R016B	Power Valve Governor O-ring	\$0.74	93210-15639-00		
					R54X3V	Exhaust Gasket 2-Req.	\$3.57	93210-53638-00		
					<b>Bottom End Kit w/crank seals</b>	<b>List Price</b>	<b>Component Part#</b>	<b>Component Description</b>	<b>List Price</b>	<b>OEM Part #</b>
					C7507	\$38.33	R101X2B	Outer Head O-ring	\$2.14	93211-02703-00
							R73X2V	Inner Head O-ring	\$3.71	93210-74316-00
							B0372032AFM	Base Gasket	\$7.44	5CU-11351-00
							B0372018AFM	High Compression Base Gasket	\$7.44	
							PV082018AFM	Right Side Power Valve Gasket	\$7.44	5CU-11993-00
							PV083018AFM	Front Power Valve Gasket	\$7.44	5CU-11354-00
		R016B	Power Valve Governor O-ring	\$0.74	93210-15639-00					
		R54X3V	Exhaust Gasket 2-Req.	\$3.57	93210-53638-00					
		IR114018AFM	Intake Gasket	\$3.80	5NX-13622-00					

All Component Parts can be purchased individually.



**WARNING:** Cancer and Reproductive Harm [www.P65Warnings.ca.gov](http://www.P65Warnings.ca.gov)



# MX/Dirt • Off-Road Gaskets



Cometic Gasket - An Exclusive NASCAR Performance® Product

## YAMAHA YZ250

Model	Year	Bore Siz	Top End Kit	List Price	Component Part#	Component Description	List Price	OEM Part #
YZ250	02-19	72mm	C3592	\$49.40	H0873SP2020S	Cylinder Head Gasket	\$49.40	
Forward Motion and Cylinder Works					B0372032AFM	Base Gasket	\$7.44	5CU-11351-00
72mm Bore Kits					PV082018AFM	Right Side Power Valve Gasket	\$7.44	5CU-11993-00
					PV083018AFM	Front Power Valve Gasket	\$7.44	5CU-11354-00
					R016B	Power Valve Governor O-ring	\$0.74	93210-15639-00
					R54X3V	Exhaust Gasket 2-Req.	\$3.57	93210-53638-00
					IR114018AFM	Intake Gasket	\$3.80	5NX-13622-00

Model	Year	O-Ring	Bottom End Kit w/Oil Seals	List Price	Component Part#	Component Description	List Price #	OEM Part #
YZ250	99-19	O-Ring	C7507BE	\$74.14	R127V	Crank Case Coolant Seal	\$3.92	5CU-15454-00-00
					EC300032AFM	Inner Clutch Cover	\$7.44	5CU-15462-00-00
					WP068018AFM	Water Pump Cover Gasket	\$7.44	5XF-12428-00-00
					WA133	Clutch Pushrod Retainer Seal	\$0.90	90430-05242-00
					WA080043C	Water Pump Drain Washer	\$0.57	90430-06014-00
					WA080043C	Water Pump Drain Plug Gasket	\$0.57	90430-06014-00
					WA114	Drain Plug Gasket	\$3.02	90430-12207-00
					R117B	Fill Plug O-ring	\$0.42	93210-19123-00
					R12X2V	Output Shaft O-ring	\$4.09	93210-22298-00
					OS227	Inner Water Pump Seal	\$2.67	93102-12321-00
					OS286	Clutch Pushrod Seal	\$4.29	93102-12224-00
					OS286	Shift Shaft Seal	\$4.29	93102-12224-00
					OS323	Start Shaft Seal	\$4.46	93102-18278-00
					OS110	Left Crank Seal	\$9.47	93102-20485-00
					OS184	Right Crank Seal	\$11.87	93102-28004-00
					OS119	Right Crank Seal 99-00	\$7.10	93103-36182-00
					OS242	Outer Water Pump Seal	\$2.67	93109-11073-00
					OS284	Output Shaft Seal	\$5.09	93102-32M07-00
					C7528	Clutch Cover Gasket	\$8.91	5CU-15463-00
					EC299060AFM	Mag Cover Gasket	\$7.44	5CU-15451-00
YZ250	99-01	O-Ring	Crank Seal Kit C7670	\$12.78	OS119	Right Crank Seal 34X55X10	\$7.10	93103-40091-00
					OS110	Left Crank Seal 20X40X7	\$9.47	93102-20485-00
YZ250	02-14	O-Ring	Crank Seal Kit C7803	\$14.38	OS184	Right Crank Seal 26X55X10	\$11.87	93102-28004-00
					OS110	Left Crank Seal 20X40X7	\$9.47	93102-20485-00
TTR250	99-06	75 mm	Top End Kit C7726	\$34.47	H0461043F	Head Gasket	\$24.75	4GY-11181-01-00
					H0461SP1043F	Big Bore Head Gasket 83mm	\$24.75	
					B0391020F	Base Gasket	\$6.19	4GY-11351-00-00
					B0391SP1020F	Big Bore Base Gasket	\$8.69	
					EC353020F	Clutch Cover Gasket	\$9.94	4GY-15461-00-00

All Component Parts can be purchased individually.



**WARNING:** Cancer and Reproductive Harm www.P65Warnings.ca.gov



# MX/Dirt • Off-Road Gaskets



Cometic Gasket - An Exclusive NASCAR Performance® Product

## YAMAHA WR250F

Model	Year	Bore Size	Top End Kit	List Price	Component Part#	Component Description	List Price	OEM Part #
WR250F	01-13	77 mm	C7905-EST	\$68.59	H1168SP3027S	Head Gasket	\$31.15	5NL-11181-00-00
		79 mm	C3057-EST	\$68.59	H1168SP2027S	Head Gasket 79mm Bore	\$31.15	
		81 mm	C3059-EST	\$68.59	H1271027S	Head Gasket 81mm Bore	\$31.15	
		83 mm	C3061-EST	\$68.59	H1272SP3027S	Head Gasket 84mm Bore	\$31.15	
		84 mm	C3120-EST	\$68.59	B0503020RC	Base Gasket	\$13.74	5NL-11351-00-00
					EX651	Exhaust Gasket	\$8.98	5NL-14613-00-00
					EC019032AFM	AFM Cam Chain Tens. Gasket	\$2.04	4FM-12213-00
					3179V	Exhaust Valve Seal 2 Req.	\$5.50 ea.	4SV-12119-00-00
			3233V	Intake Valve Seal 3 Req.	\$5.11 ea.	4TV-12119-00-00		

Bottom End Kit w/Oil Seals		List Price	Component Part#	Component Description	List Price #	OEM Part #
C3561BE	\$77.84	EC554032AFM	Inner Clutch Cover Gasket	\$9.94	5NL-15462-00-00	
		R011B	Oil Delivery Pipe O-Ring (SM)	\$1.13	93210-07003-00/ 07540-00	
		R013B	Oil Delivery Pipe O-Ring (3)	\$1.19	93210-10197-00	
		R014B	Oil Delivery Pipe O-Ring (LG)	\$0.40	93210-12759-00	
		R016B	Base and Case Dowel O-ring	\$0.74	93210-16716-00 / 93210-16772-00	
		R109B	Oil Filter O-Ring (SM) (2)	\$1.13	93210-07135-00	
		R10X2V	Center Case Dowel O-ring	\$1.59	93210-10197-00*	
		R113B	Timing Mark Plug O-Ring	\$1.19	93210-14369-00	
		R120V	Electric Starter O-ring	\$1.25	93210-25711-00	
		R121V	Crank End Plug O-ring	\$1.25	93210-27370-00/ 93210-27778-00	
		R134B	Oil Filter O-Ring	\$1.13	93210-47675-00	
		R19X2V	Oil Fill Plug O-ring	\$2.50	93210-19123-00	
		R141SB	Starter Gear O-ring	\$18.99	93210-60426-00	
		R903B	Oil Delivery Pipe O-Ring (MED)	\$6.35	93210-09008-00	
		WA080043C	Water Pump Drain Washer	\$0.57	90430-06014-00	
		WA082063C	Oil Line Crush Washer (2)	\$1.93	90430-10188-00	
		WA082063C	Oil Drain Bolt Washer	\$1.93	90430-10188-00*/ 10171-00	
		WA116	Oil Line Crush Washer (2)	\$3.02	90430-08119-00	
		WP297	Water Pump Cover O-ring	\$5.19	5NL-12439-00-00	
		R116B	Kickstart O-ring	\$1.13	93210-17570-00	

Oil Seal Kit	List Price	Component Part#	Component Description	List Price #	OEM Part #
C3561OS	\$30.91	OS227	Inner Water Pump Seal	\$2.67	93102-12321-00
		OS236	Oil Pump Seal	\$4.23	93101-14164-00
		OS283	Outer Water Pump Seal	\$4.34	93109-11073-00
		OS286	Shift Shaft Seal	\$4.29	93102-12224-00
		OS286	Hot Start Mech Oil Seal	\$4.29	93102-12224-00
		OS323	Start Shaft Seal	\$4.46	93102-18278-00
		OS324	Output Shaft Seal	\$6.63	93102-28010-00

Clutch & Mag Kit	List Price	Component Part#	Component Description	List Price	OEM Part #
C3561CM	\$12.09	EC553032AFM	Outer Clutch Cover Gasket	\$4.65	5NL-15453-10-00
		EC1931032AFM	Mag Cover Gasket	\$7.44	5UM-15451-00-00

All Component Parts can be purchased individually.



**WARNING:** Cancer and Reproductive Harm [www.P65Warnings.ca.gov](http://www.P65Warnings.ca.gov)





# MX/Dirt · Off-Road Gaskets



Cometic Gasket - An Exclusive NASCAR Performance® Product

## YAMAHA YZ250F

Model	Year	Bore Size	Top End Kit	List Price	Component Part#	Component Description	List Price	OEM Part #
YZ250F	01-13	77 mm	C7905-EST	\$68.59	H1168SP3027S	Head Gasket	\$31.15	5NL-11181-00-00
		79 mm	C3057-EST	\$68.59	H1168SP2027S	Head Gasket 79mm Bore	\$31.15	
		81 mm	C3059-EST	\$68.59	H1271027S	Head Gasket 81mm Bore	\$31.15	
		83 mm	C3061-EST	\$68.59	H1272SP3027S	Head Gasket 84mm Bore	\$31.15	
		84 mm	C3120-EST	\$68.59	B0503020RC	Base Gasket	\$13.74	5NL-11351-00-00
					EX651	Exhaust Gasket	\$8.98	5NL-14613-00-00
					EC019032AFM	AFM Cam Chain Tens. Gasket	\$2.04	4FM-12213-00
					3179V	Exhaust Valve Seal 2 Req.	\$5.50 ea.	4SV-12119-00-00
					3233V	Intake Valve Seal 3 Req.	\$5.11 ea.	4TV-12119-00-00

Bottom End Kit w/Oil Seals	List Price	Component Part#	Component Description	List Price #	OEM Part #
C3057BE	\$74.14	EC554032AFM	Inner Clutch Cover Gasket	\$9.94	5NL-15462-00-00
		R011B	Oil Delivery O-ring (SM)	\$1.08	93210-07003-00/07540-00
		R013B	Oil Pump Seal O-Ring	\$1.19	93210-10197-00*
		R013B	Clutch Side Oil Feed Line O-Ring	\$1.19	93210-10197-00*
		R013B	Mag Side Oil Feed Line O-Ring	\$1.19	93210-10197-00*
		R014B	Oil Delivery Pipe O-Ring (Lg.)	\$1.08	93210-12759-00
		R016V	Case Dowel O-ring	\$1.19	93210-16772-00
		R109B	Oil Filter Cover O-Ring (Sm.)	\$1.13	93210-07135-00
		R10X2V	Centercase Dowel O-ring	\$1.59	93210-10197-00*
		R113B	Timing Plug O-ring	\$1.19	93210-14369-00
		R124B	Crank End Plug O-ring	\$3.92	93210-32172-00
		R134B	Oil Filter O-Ring (LG)	\$1.13	93210-47675-00
		R19X2V	Oil Fill Plug O-ring	\$2.50	93210-19123-00
		R903V	Oil Delivery Pipe O-ring (Med.)	\$1.19	93210-09008-00
		WA080043C	Coolant Drain Bolt Washer	\$0.57	90430-06014-00*
		WA082063C	Oil Drain Bolt Washer	\$1.93	90430-10188-00*/10171-00
		WP297	Water Pump O-Ring	\$5.19	5NL-12439-00-00
<b>Oil Seal Kit</b>	<b>List Price</b>	<b>Component Part#</b>	<b>Component Description</b>	<b>List Price #</b>	<b>OEM Part #</b>
C3057OS	\$33.45	OS323	Kick Start Shaft Seal	\$4.46	93102-18278-00
		OS324	Countershaft Oil Seal	\$6.63	93102-28010-00
		OS283	Outer Water Pump Seal	\$4.34	93109-11073-00
		OS227	Inner Water Pump Seal	\$5.21	93102-12106-00
		OS236	Oil Pump Seal	\$4.23	93101-14164-00
		OS286	Gear Selector Seal	\$4.29	93102-12224-00
<b>Clutch &amp; Mag Kit</b>	<b>List Price</b>	<b>Component Part#</b>	<b>Component Description</b>	<b>List Price</b>	<b>OEM Part #</b>
C3057CM	\$12.09	EC553032AFM	Clutch Cover Gasket	\$4.65	5NL-15453-00-00
		EC527060AFM	Mag. Cover Gasket	\$7.44	5NL-15451-00-00

All Component Parts can be purchased individually.



**WARNING:** Cancer and Reproductive Harm [www.P65Warnings.ca.gov](http://www.P65Warnings.ca.gov)



# MX/Dirt • Off-Road Gaskets



Cometic Gasket - An Exclusive NASCAR Performance® Product

## YAMAHA YZ250F

Model	Year	Bore Size	Top End Kit	List Price	Component Part#	Component Description	List Price	OEM Part #
YZ250F	14-18	77mm	C3549-EST	\$61.00	H3885027S	Head Gasket 77mm Bore	\$29.77	1SM-11181-00-00
WR250F	15-18	80mm	C3550-EST	\$61.00	H3885SP4027S	Head Gasket 80mm Bore	\$29.77	
					B1236010RC	Base Gasket	\$12.69	1SM-11351-00-00
					EX651	Exhaust Gasket	\$8.98	5NL-14613-00-00
					EC019032AFM	Cam Chain Tensioner Gasket	\$2.04	4FM-12213-00-00
					3239V	Exhaust Valve Stem Seal 2 req.	\$5.50	4TE-12119-00-00
					3234V	Intake Valve Stem Seal 2 req.	\$5.50	33M-12119-00-00
					WA114	Cylinder Head Drain Seal	\$3.02	90430-06014-00
					WA140	Cam Chain Tens. Crush Seal	\$0.63	5EL-12214-00-00
					R020V	TPS O-ring	\$1.19	1DX-14562-00-00

Bottom End Kit w/Oil Seals		Component Part#	Component Description	List Price #	OEM Part #
C3549BE	\$74.14	WA082063C	Case Drain Crush Washer	\$1.93	90430-10188-00
		R117B	Fill Plug O-ring	\$0.42	93210-19123-00
		R13.5X2V	Timing Mark O-ring	\$1.93	93210-14369-00
		R127V	Timing Plug O-ring	\$3.92	93210-357A3-00
		R115V	Water Pump Coolant Elb. O-ring	\$1.13	93210-16500-00
		R116B	Kickstart O-ring	\$1.13	93210-17570-00
		R016V	Case Water Pipe O-ring	\$1.19	93210-16716-00
					93210-16772-00
		WA080043C	Water Pump Drain Plug	\$0.57	90430-06014-00
		EC1935032AFM	Inner Clutch Cover Gasket	\$9.94	1SM-15462-00-00
		R013V	Oil Filter O-ring	\$2.34	93210-45708-00
		R014V	Oil Pump O-ring	\$1.08	93210-12010-00
		R014V	Coolant Elbow O-ring	\$1.08	93210-16275-00
		WP439032AFM	Water Pump Gasket	\$10.61	33D-12427-00-00

Oil Seal Kit	List Price	Component Part#	Component Description	List Price #	OEM Part #
C3549OS	\$33.45	OS236	Water Pump Oil Seal	\$4.23	93101-14164-00
		OS323	Start Shaft Seal	\$4.46	93102-18278-00
		OS229	Clutch Actuator Seal	\$1.99	93102-10008-00
		OS197	Shift Shaft Seal	\$2.46	93109-14010-00
		OS235	Output Shaft Seal	\$6.85	93102-28012-00
		OS308	Outer Water Pump Seal	\$2.95	93102-08004-00
		OS233	Inner Water Pump Seal	\$3.62	93102-08307-00

Clutch & Mag Kit	List Price	Component Part#	Component Description	List Price	OEM Part #
C3549CM	\$12.04	EC1941032AFM	Outer Clutch Cover Gasket	\$7.04	1SM-15453-00-00
		EC1942032AFM	Mag Cover Gasket	\$5.00	1SM-15451-00-00

Model	Year	Bore Size	Top End Kit	List Price	Component Part#	Component Description	List Price	OEM Part #
YZ250F	2019	77mm	C3695	\$64.99	EC019018AFM	Cam Chain Tensioner	\$2.04	4FM-12213-00-00
					H4659027S	Cylinder Head Gasket	\$29.77	B7B-11181-00-00
					WA080043C	Water Passage Crush Washer	\$0.57	90430-06014-00
					B1432010RC	Cylinder Base Gasket	\$12.69	B7B-11351-00-00
					EX651	Header Gasket	\$8.98	5NL-14613-00-00
					3239V	Exhaust Valve Seal	\$5.08	4TE-12119-00-00
					3234V	Intake Valve Seal	\$5.50	33M-12119-00-00

Clutch & Mag Kit	List Price	Component Part#	Component Description	List Price	OEM Part #
C3695CM		EC2464032AFM	Outer Clutch Cover Gasket	\$7.04	
		EC2466018AFM	Mag Cover Gasket	\$5.00	

## YAMAHA XT350

Model	Year	Bore Size	Top End Kit	List Price	Component Part#	Component Description	List Price	OEM Part #
XT350	85-99	87.5 mm	C7530	\$21.76	H0836043F	Head Gasket	\$14.87	55V-11181-00-00
					B0388020F	Base Gasket	\$6.19	4DR-11351-00



# MX/Dirt • Off-Road Gaskets



Cometic Gasket - An Exclusive NASCAR Performance® Product

## YAMAHA YZ400F

Model	Year	Bore Size	Top End Kit	List Price	Component Part#	Component Description	List Price	OEM Part #
YZ400F	98-99	92 mm	C7400	\$38.33	H0707027S	Head Gasket	\$38.44	5BE-11181-00-00
		94 mm	C7401	\$38.33	H0709027S	Head Gasket 94mm Bore	\$38.44	
		95 mm	C7689	\$38.33	H0869027S	Head Gasket 95mm Bore	\$38.44	
		97 mm	C7470	\$38.33	H0725027S	Head Gasket 97mm Bore	\$38.44	
						B0334020RC	Base Gasket	\$6.25
				EC019018AFM	Cam Chain Tensioner Gasket	\$2.04	4FM-12213-00	
			<b>Bottom End Kit</b>	<b>List Price</b>	<b>Component Part#</b>	<b>Component Description</b>	<b>List Price</b>	<b>OEM Part #</b>
			w/o crank seals					
			C3303	\$19.99	C7487	Outer Clutch Cover Gasket	\$10.22	5BE-15453-00
					EC292060AFM	Mag Cover Gasket	\$6.19	5BE-15451-00
					EC293032AFM	Inner Clutch Cover Gasket	\$8.69	5BE-15462-00
			<b>Clutch &amp; Mag Kit</b>	<b>List Price</b>	<b>Component Part#</b>	<b>Component Description</b>	<b>List Price</b>	<b>OEM Part #</b>
			C7400CM	\$16.41	C7487	Outer Clutch Cover Gasket	\$10.22	5BE-15453-00
					EC292060AFM	Mag Cover Gasket	\$6.19	5BE-15451-00

## YAMAHA YZ426F

Model	Year	Bore Size	EST Top End Kit	List Price	Component Part#	Component Description	List Price	OEM Part #
YZ400	98-99	92 mm	C7400-EST	\$64.27	H0707027S	Head Gasket	\$38.44	5BE-11181-00-00
YZ426F,	00-02	94 mm	C7401-EST	\$64.27	H0709027S	Head Gasket 94mm Bore	\$38.44	
WR426		95 mm	C7689-EST	\$64.27	H0869027S	Head Gasket 95mm Bore	\$38.44	5JG-11181-00-00
		97 mm	C7470-EST	\$64.27	H0725027S	Head Gasket 97mm Bore	\$38.44	
					B0334020RC	Base Gasket	\$6.25	5BE-11351-00-00
					EC019018AFM	Cam Chain Tensioner Gasket	\$2.04	4FM-12213-00
					EX641	Header Gasket	\$10.96	3VD-14613-01-00
					WA082063C	Crush Washers Oil Line	\$1.93	90430-10188-00
					Banjo Bolt (2)			
					3179V	Intake Valve Seal (3)	\$5.50	4SV-12119-00-00
					3234V	Exhaust Valve Seal (2)	\$5.50	33M-12119-00-00
YZ426F,	00-02		<b>Bottom End Kit</b>	<b>List Price</b>	<b>Component Part#</b>	<b>Component Description</b>	<b>List Price #</b>	<b>OEM Part #</b>
WR426			C7689BE	\$70.75	EC293032AFM	Primary Cover Gasket	\$5.00	5BE-15462-00-00
					R013B	Case Dowel O-ring	\$1.19	93210-10197-00
					R013B	Oil Pump Dowel O-ring	\$1.19	93210-10197-00
					R013B	Oil Delivery Line O-rings (4)	\$1.19	93210-10197-00
					R014B	Oil Delivery Pipe O-ring Outer	\$0.40	93210-12759-00
					R109B	Oil Filter Cover Passage O-rings (3)	\$1.13	93210-07135-00
					R124B	Timing Gear O-ring	\$3.92	93210-32172-00
					R12X2V	Output Shaft Backup O-ring	\$1.19	93210-22298-00
					R13.5X2V	Timing Mark O-ring	\$1.93	93210-14369-00
					R134B	Oil Filter Cover O-ring	\$1.13	93210-47675-00
					R7X2V	Oil Delivery Pipe O-ring inner	\$2.16	93210-07540-00
					R903V	Oil Delivery Pipe O-ring middle	\$1.19	93210-09008-00
					WA116	Crush Washers Oil Line (4)	\$1.06	90430-08119-00
					WA137	Drain Plug Crush Washer	\$1.53	90430-12213-00
					WP189	Water Pump Cover Gasket	\$8.73	5BE-12439-00-00
					R018V	Oil Passage O-rings	\$1.19	93210-19758-00
			<b>Oil Seal Kit</b>	<b>List Price</b>	<b>Component Part#</b>	<b>Component Description</b>	<b>List Price #</b>	<b>OEM Part #</b>
			C7689OS	\$24.77	OS227	Shift Shaft Seal	\$2.67	93102-12321-00
					OS236	Water Pump Seal	\$4.23	93101-14164-00
					OS284	Output Shaft Seal	\$5.09	93102-32480-00
					OS285	Start Shaft Seal	\$1.48	93102-20108-00
					OS286	Clutch Actuator Seal	\$4.29	93102-12224-00
					OS283	Water Pump Impeller Seal	\$4.34	93109-11073-00
					OS227	Inner Water Pump Seal	\$2.67	93102-12321-00
			<b>Clutch &amp; Mag Kit</b>	<b>List Price</b>	<b>Component Part#</b>	<b>Component Description</b>	<b>List Price</b>	<b>OEM Part #</b>
			C7689CM	\$13.34	EC292018AFM	Mag Cover Gasket	\$8.69	5BE-15451-00-00
					EC789032AFM	Clutch Cover Gasket	\$4.65	5JG-15453-00-00

All Component Parts can be purchased individually.



**WARNING:** Cancer and Reproductive Harm www.P65Warnings.ca.gov



# MX/Dirt • Off-Road Gaskets



Cometic Gasket - An Exclusive NASCAR Performance® Product

## YAMAHA YZ450F

Model	Year	Bore Size	EST	List Price	Component Part#	Component Description	List Price	OEM Part #
YZ450F	03-05	95 mm 96 mm 97 mm 98 mm 99 mm 100 mm	<b>Top End Kit</b>					
			C7947-EST	\$89.38	H1710027S	Head Gasket	\$40.93	5TA-11181-00-00
			C3147-EST	\$89.38	H2144027S	Head Gasket 96mm Bore	\$40.93	
			C3064-EST	\$89.38	H1711027S	Head Gasket 97mm Bore	\$40.93	
			C3148-EST	\$89.38	H1683027S	Head Gasket 98mm Bore	\$40.93	
			C3149-EST	\$89.38	H1683SP2027S	Head Gasket 99mm Bore	\$40.93	
			C3117-EST	\$89.38	H1683SPB027S	Head Gasket 100mm Bore	\$40.93	
					B0626020RC	Base Gasket	\$11.81	5TA-11351-00-00
					B0626SP2020RC	Base Gasket 100mm Kits	\$11.81	
					EX641	Exhaust Gasket	\$10.96	3VD-14613-01-00
					EC019018AFM	Cam Chain Tensioner Gasket	\$2.04	4FM-12213-00
					EC019020F	Cam Chain Tensioner Gasket	\$2.04	
					WA082063C	Oil Line Washers 2 Req.	\$1.93	90430-10171
					3179V	Intake Valve Seal 3 Req.	\$5.50 ea.	4SV-12119-00-00
					3234V	Exhaust Valve Seal 2 Req.	\$5.50 ea.	33M-12119-00-00
					WA114	Head Drain Washers	\$3.02	90430-06014
					WA116	Oil Line Washers 4 Req.	\$3.02	90201-08087-00
<b>Bottom End Kit w/Oil Seals</b>								
		C7947BE	\$75.99	WP189	Water Pump Cover O-ring			5BE-12439-00-00
				EC762032AFM	Inner Clutch Cover	\$8.69		5TA-15462-00-00
				WA080043C	Coolant Drain Gasket	\$0.57		90430-06014-00
				WA080043C	Water Pump Drain Gasket	\$0.57		90430-06014-00
				WA116	Oil Line Crush Washer	\$3.02		90430-08119-00
				WA082063C	Drain Plug Gasket	\$1.93		90430-10188-00
				WA082063C	Oil Line Crush Washer	\$1.93		90430-10188-00
				R109B	Oil Filter Cover O-rings	\$1.13		93210-07135-00
				R903V	Oil Pipe O-ring	\$1.19		93210-09008-00
				R013B	Case Dowel O-ring	\$1.19		93210-10197-00
				R014B	Oil Pipe O-ring	\$0.40		93210-12759-00
				R027V	Timing Mark O-ring	\$1.19		93210-14369-00
				R114B	Water Pipe O-ring	\$1.13		93210-16500-00
				R19X2V	Fill Plug O-ring	\$2.50		93210-19123-00
				R018V	Water Outlet O-rings	\$1.19		93210-19758-00
				R12X2V	Output Shaft O-ring	\$1.19		93210-22298-00
				R124B	Timing Gear O-ring	\$3.92		93210-32172-00
				R134B	Oil Filter Cover O-ring	\$1.13		93210-47675-00
<b>Oil Seal Kit</b>								
		C7947OS	\$29.88	OS227	Inner Water Pump Oil Seal	\$2.67		93102-12321-00
				OS236	Oil Pump Seal	\$4.23		93101-14164-00
				OS242	Outer Water Pump Oil Seal	\$4.34		93109-11073-00
				OS284	Output Shaft Seal	\$5.09		93102-32480-00
				OS285	Kick Start Shaft Seal	\$1.48		93102-20108-00
				OS286	Hot Start Lever Oil Seal	\$4.29		93102-12224-00
				OS286	Clutch Pushrod Seal	\$4.29		93102-12224-00
				OS286	Shift Shaft Seal	\$4.29		93102-12224-00
<b>Clutch &amp; Mag Kit</b>								
		C7947CM	\$14.94	EC761018AFM	Mag Cover Gasket	\$5.00		5TA-15451-00-00
				C3129	Outer Clutch Cover Gasket	\$9.94		5TA-15453-00-00
				<b>Component Part#</b>	<b>Component Description</b>	<b>List Price</b>		<b>OEM Part #</b>
				VC104	Valve Cover Gasket	\$23.80		



# MX/Dirt · Off-Road Gaskets



Cometic Gasket - An Exclusive NASCAR Performance® Product

## YAMAHA YZ450F

Model	Year	Bore Size	EST	List Price	Component Part#	Component Description	List Price	OEM Part #
YZ450F	06-09	95 mm	<b>Top End Kit</b>					
			C7908-EST	\$73.79	H2477027S	Head Gasket 95mm	\$31.15	2S2-11181-00-00
		98 mm	C3178-EST	\$73.79	H2477SP1027S	Head Gasket 98mm	\$31.15	2S2-11181-00-00
			C3279-EST	\$73.79	H2477SP4027S	Head Gasket 99mm	\$31.15	2S2-11181-00-00
					B0849020RC	Base Gasket	\$11.87	2S2-11351-00-00
					EX696	Exhaust Gasket	\$10.28	3VD-14613-01-00
					3179V	Intake Valve Seal 3 Req.	\$5.50 ea.	4SV-12119-00-00
					3234V	Exhaust Valve Seal 2 Req.	\$5.50 ea.	33M-12119-00-00
					EC019018AFM	Cam Chain Tensioner Gasket	\$2.04	4FM-12213-00
					WA082063C	Oil Line Washers 2 Req.	\$1.93	90430-10171
			WA114	Drain Plug Gasket	\$3.02	90430-06014		
			WA116	Oil Line Washers 4 Req.	\$3.02	90201-08087-00		
<b>Bottom End Kit w/Oil Seals</b>								
			C7908BEF	\$75.99	EC1100031F	Inner Clutch Cover	\$23.80	2S2-15462-10-00
					WP189	Water Pump Cover Gasket	\$8.73	5BE-12439-00-00
					WA080043C	Water Pump Drain Crush Washer 0.57		90430-06014-00
					WA080043C	Case Oil Galley Drain Plug	\$0.57	90430-06014-00
					WA116	Case Water Galley Drain Plug	\$3.02	90430-08119-00
					WA082063C	Drain Plug Crush Seal	\$1.93	90430-10188-00
					R109B	Oil Pump O-rings	\$1.13	93210-07135-00
					R011V	Mag Cover Oil Passage O-ring	\$1.13	93210-08003-00
					R012B	Case Oil Level Plug O-ring	\$0.51	93210-09350-00
					R013B	Case Oil Galley O-ring	\$1.19	93210-10197-00
					R113B	Timing Mark O-ring	\$1.19	93210-14369-00
					R19X2V	Fill Plug O-Ring	\$2.50	93210-19123-00
					R018V	Primary Cover Oil Passage O-ring	\$1.19	93210-19758-00
					R12X2V	Output Shaft O-ring	\$1.19	93210-22298-00
					R121V	Crank End Plug O-ring	\$1.25	93210-27778-00
					R134B	Oil Pump Cover O-ring	\$1.13	93210-47675-00
					R143V	Electric Starter Cover O-ring	\$1.79	93210-58346-00
<b>Oil Seal Kit</b>								
			C7908OS	\$29.88	OS227	Inner Water Pump Oil Seal	\$2.67	93102-12321-00
					OS236	Oil Pump Seal	\$4.23	93101-14164-00
					OS242	Outer Water Pump Oil Seal	\$4.34	93109-11073-00
					OS284	Output Shaft Seal	\$5.09	93102-32480-00
					OS285	Kick Start Shaft Seal	\$1.48	93102-20108-00
					OS286	Clutch Pushrod Seal	\$4.29	93102-12224-00
					OS286	Shift Shaft Seal	\$4.29	93102-12224-00
<b>Clutch &amp; Mag Kit</b>								
			C7908CM	\$20.62	EC763020F	Outer Clutch Cover	\$9.94	5TA-15453-00-00
					EC1099031F	Mag Cover Gasket	\$10.68	2S2-15451-00-00
					VC104	Valve Cover Gasket	\$23.80	

All Component Parts can be purchased individually.

**WARNING:** Cancer and Reproductive Harm [www.P65Warnings.ca.gov](http://www.P65Warnings.ca.gov)





# MX/Dirt • Off-Road Gaskets



Cometic Gasket - An Exclusive NASCAR Performance® Product

## YAMAHA YZ450F

Model	Year	Bore Size	EST Top End Kit	List Price	Component Part#	Component Description	List Price	OEM Part #
YZ450F	10-13	97mm	C3395-EST	\$55.65	H3059027S	97mm Bore Head Gasket	\$31.15	33D-11181-00-00
					3238V	Valve Stem Seals 4 Required	\$1.36 ea.	51Y-12119-00-00
					B1019010RC	Base Gasket	\$13.62	33D-11351-00-00
					EC019032AFM	Cam Chain Tensioner Gasket	\$2.04	4FM-12213-00-00
					EX1041042AM	Exhaust Gasket	\$4.65	33D-14613-00-00
					<b>Bottom End Kit w/Oil Seals</b>			
			C3395BE	\$75.99	EC1569032AFM	Inner Clutch Gasket	\$23.80	33D-15462-00-00
					R18X2.5V	Oil Fill Plug O-ring	\$1.71	93210-19123-00
					R13.5X2V	Timing Mark O-ring	\$1.93	93210-14369-00
					R126B	Crank Plug O-ring	\$1.13	93210-357A3-00
					R010V	Oil Nozzle O-ring	\$0.40	93210-07001-00
					MR111	Case Seal Gasket	\$3.70	90430-08002-00
					WA116	Right Case Drain Washer	\$3.02	90201-08087-00
					WA080043C	Left Case Drain Washer	\$0.57	90430-06014-00
					R031B	Oil Filter Cover O-ring	\$4.65	93210-45708-00
					R24X2V	Coolant Line Oring	\$6.19	93210-24253-00
					R114B	Water Pump O-ring	\$1.13	93210-16500-00
					R020V	Output Shaft O-ring	\$1.19	93210-22298-00
					WP379018AFM	Water Pump Housing Gasket	\$5.19	33D-12427-00-00
					WA114	Water Pump Drain Plug Washer	\$3.02	90430-06014-00
					R018V	Water Pipe O-ring	\$1.19	93210-19758-00
<b>Oil Seal Kit</b>								
			C3395OS	\$25.99	OS285	Start Shaft Seal 20x30x7	\$1.48	93102-20108-00
					OS284	Output Shaft Seal 32x42x6	\$8.83	93102-32480-00
					OS286	Shift Shaft Oil Seal 12x18x5	\$4.29	93102-12224-00
					OS227	Water Pump Shaft Seal 12x22x5	\$2.67	93102-12321-00
					OS236	Water Pump Oil Seal 14x22x5	\$4.23	93101-14164-00
YZ450F	14-17	97mm	C3540-EST	\$55.65	H3059027S	97mm Bore Head Gasket	\$31.15	33D-11181-00-00
					3238V	Valve Stem Seals 4 Required	\$1.36 ea.	51Y-12119-00-00
					B1241010RC	Base Gasket	\$13.62	1SL-11351-00-00
					EC019032AFM	Cam Chain Tensioner Gasket	\$2.04	4FM-12213-00-00
					EX1041042AM	Exhaust Gasket	\$4.65	33D-14613-00-00
					<b>Bottom End Kit w/Oil Seals</b>			
			C3540BE	\$79.00	WA082063C	Drain Plug Crush Gasket	\$1.93	90430-10188-00
					WA118	Output Shaft Crush Gasket	\$1.88	90430-06166-00
					R19X2V	Fill Plug O-ring	\$2.50	93210-19123-00
					R127V	Timing Gear O-ring	\$3.92	93210-357A3-00
					R027V	Timing Mark O-ring	\$1.10	93210-14369-00
					WA080043C	Mag Crush Washer	\$0.57	90430-06014-00
					R031B	Oil Filter O-ring	\$4.65	93210-45708-00
					R014V	Oil Strainer O-ring	\$1.08	93210-12010-00
					WP439032AFM	Water Pump Gasket	\$10.61	33D-12427-00-00
					WA080043C	Water Pump Crush Washer	\$0.57	90430-06014-00
					R018V	Water Pipe O-ring	\$1.19	93210-19758-00
					EC2169032AFM	Oil Passage Gasket	\$4.97	1SL-13475-00-00
					EC2171032AFM	Inner (Primary) Cover	\$17.62	1SL-15462-00-00
					R22X2V	Output Shaft O-ring	\$2.66	93210-22164-00
						Oil Pump O-ring	\$1.73	90430-06156-00
<b>Oil Seal Kit</b>								
			C3540OS	\$23.05	OS236	Oil Pump Seal	\$4.23	93101-14164-00
					OS197	Shift Shaft Seal	\$2.46	93109-14010-00
					OS285	Kickstart Shaft Seal	\$1.48	93102-20108-00
					OS284	Output Shaft Seal	\$5.09	93102-32480-00
					OS308	Outer Water Pump Seal	\$5.89	93102-08004-00
					OS233	Inner Water Pump Seal	\$3.62	93102-08307-00
<b>Clutch &amp; Mag Kit</b>								
			C3540CM	\$15.21	MR110	Outer Clutch Cover	\$9.71	33D-15453-00-00
					EC2170032AFM	Mag Cover Gasket	\$5.50	1SL-15451-00-00

All Component Parts can be purchased individually.



**WARNING:** Cancer and Reproductive Harm [www.P65Warnings.ca.gov](http://www.P65Warnings.ca.gov)



# MX/Dirt · Off-Road Gaskets



Cometic Gasket - An Exclusive NASCAR Performance® Product

## YAMAHA YZ450F

Model	Year	Bore Size	Top End Kit	List Price	Component Part#	Component Description	List Price	OEM Part #
YZ450F	18-19	97mm	C3630	\$43.95	H4566023S	97mm Bore Head Gasket	\$31.15	BR9-11181-00-00
					B1400010RC	Cylinder Base Gasket	\$13.62	BR9-11351-00-00
					3238V	Valve Stem Seals	\$1.36 ea.	51Y-12119-00-00
					EX1041042AM	Header Gasket	\$4.65	33D-14613-00-00
					WA116	Cam Galley Drain Crush Washer	\$1.06	90430-08119-00
					WA080043C	Cam Galley Drain Crush Washer	\$0.57	90430-06014-00
					WA140	Cam Chain Tensioner Release Washer	\$0.63	5EL-12214-00-00
					WA114	Cam Chain Tensioner Crush Washer	\$3.02	90430-06014-00
					EC019018AFM	Cam Chain Tensioner Gasket	\$2.04	4FM-12213-00-00
			<b>Oil Seal Kit</b>	<b>List Price</b>	<b>Component Part#</b>	<b>Component Description</b>	<b>List Price #</b>	<b>OEM Part #</b>
			C3540OS	\$23.05	OS236	Oil Pump Seal	\$4.23	93101-14164-00
					OS229	Clutch Act Oil Seal	\$1.99	93102-10008-00
					OS197	Shift Shaft Seal	\$2.46	93109-14010-00
					OS284	Output Shaft Seal Oil Seal 32X42	\$5.09	93102-32014-00
					OS308	Outer Water Pump Oil Seal	\$5.89	93102-08004-00
					OS233	Inner Water Pump Oil Seal	\$3.62	93102-08307-00
			<b>Clutch &amp; Mag Kit</b>	<b>List Price</b>	<b>Component Part#</b>	<b>Component Description</b>	<b>List Price</b>	<b>OEM Part #</b>
			C3630CM	\$15.21	EC2438032AFM	Mag Cover Gasket	\$5.50	
					MR110	Outer Clutch Cover Gasket	\$9.71	
			<b>EST</b>	<b>List Price</b>	<b>Component Part#</b>	<b>Component Description</b>	<b>List Price</b>	<b>OEM Part #</b>
			<b>Top End Kit</b>					
WR450	03-06	95 mm	C7947-EST	\$89.38	H1710027S	Head Gasket	\$40.93	5TA-11181-00-00
		96 mm	C3147-EST	\$89.38	H2144027S	Head Gasket 96mm Bore	\$40.93	
		97 mm	C3064-EST	\$89.38	H1711027S	Head Gasket 97mm Bore	\$40.93	
		98 mm	C3148-EST	\$89.38	H1683027S	Head Gasket 98mm Bore	\$40.93	
		99 mm	C3149-EST	\$89.38	H1683SP2027S	Head Gasket 99mm Bore	\$40.93	
		100 mm	C3117-EST	\$89.38	H1683SPB027S	Head Gasket 100mm Bore	\$40.93	
					B0626020RC	Base Gasket	\$11.81	5TA-11351-00-00
					B0626SP2020RC	Base Gasket 100mm Kits	\$11.81	
					EX641	Exhaust Gasket	\$10.96	3VD-14613-01-00
					EC019018AFM	Cam Chain Tensioner Gasket	\$2.04	4FM-12213-00
					EC019020F	Cam Chain Tensioner Gasket	\$2.04	
					WA082063C	Oil Line Washers 2 Req.	\$1.93	90430-10171
					3179V	Intake Valve Seal 3 Req.	\$5.50 ea.	4SV-12119-00-00
					3234V	Exhaust Valve Seal 2 Req.	\$5.50 ea.	33M-12119-00-00
					WA114	Head Drain Washers	\$3.02	90430-06014
					WA116	Oil Line Washers 4 Req.	\$3.02	90201-08087-00
			<b>Bottom End Kit w/Oil Seals</b>	<b>List Price</b>	<b>Component Part#</b>	<b>Component Description</b>	<b>List Price #</b>	<b>OEM Part #</b>
			C3560BE	\$75.99	R018V	Water Outlet O-rings	\$1.19	93210-19758-00
					WP189	Water Pump Cover O-ring	\$8.73	5BE-12439-00-00
					R12X2V	Output Shaft O-ring	\$1.19	93210-22298-00
					R114B	Water Pipe O-ring	\$1.13	93210-16500-00
					R013B	Oil Line O-rings	\$1.19	93210-10197-00
					EC762032AFM	Inner Clutch Cover	\$8.69	5TA-15462-00-00
					R19X2V	Fill Plug O-ring	\$2.50	93210-19123-00
					R143K	Starter O-ring	\$1.79	93210-58346-00
					R027V	Timing Mark O-ring	\$1.19	93210-14369-00
					R013B	Case Dowel O-ring	\$1.19	93210-10197-00
					WA082063C	Drain Plug Gasket	\$1.93	90430-10188-00
					WA080043C	Coolant Drain Gasket	\$0.57	90430-06014-00
			<b>Oil Seal Kit</b>	<b>List Price</b>	<b>Component Part#</b>	<b>Component Description</b>	<b>List Price #</b>	<b>OEM Part #</b>
			C3560OS	\$29.88	OS236	Oil Pump Seal	\$4.23	93101-14164-00
					OS283	Outer Water Pump Oil Seal	\$3.54	93109-11073-00
					OS284	Output Shaft Seal	\$5.09	93102-32480-00
					OS285	Kick Start Shaft Seal	\$1.48	93102-20108-00
					OS286	Shift Shaft Seal	\$4.29	93102-12224-00
					OS286	Clutch Pushrod Seal	\$4.29	93102-12224-00
			<b>Clutch &amp; Mag Kit</b>	<b>List Price</b>	<b>Component Part#</b>	<b>Component Description</b>	<b>List Price</b>	<b>OEM Part #</b>
			C3560CM	\$18.63	EC763018AFM	Outer Clutch Cover Gasket	\$9.94	5TA-15453-00-00
					EC2003032AFM	Mag Cover Gasket	\$10.68	5TJ-15451-00-00

All Component Parts can be purchased individually.



**WARNING:** Cancer and Reproductive Harm www.P65Warnings.ca.gov



# MX/Dirt • Off-Road Gaskets



Cometic Gasket - An Exclusive NASCAR Performance® Product

## YAMAHA WR450

Model	Year	Bore Size	EST	List Price	Component Part#	Component Description	List Price	OEM Part #
WR450	07-14	95 mm	Top End Kit					
			C7908-EST	\$73.79	H2477027S	Head Gasket 95mm	\$31.15	2S2-11181-00-00
		98 mm	C3178-EST	\$73.79	H2477SP1027S	Head Gasket 98mm	\$31.15	2S2-11181-00-00
			H2477SP4027S	Head Gasket 99mm	\$31.15	2S2-11181-00-00		
		B0849020RC	Base Gasket	\$11.87	2S2-11351-00-00			
		EX696	Exhaust Gasket	\$10.28	3VD-14613-01-00			
		3179V	Intake Valve Seal 3 Req.	\$5.50 ea.	4SV-12119-00-00			
		3234V	Exhaust Valve Seal 2 Req.	\$5.50 ea.	33M-12119-00-00			
		EC019018AFM	Cam Chain Tensioner Gasket	\$2.04	4FM-12213-00			
		WA082063C	Oil Line Washers 2 Req.	\$1.93	90430-10171			
		WA114	Drain Plug Gasket	\$3.02	90430-06014			
		WA116	Oil Line Washers 4 Req.	\$3.02	90201-08087-00			
		<b>Bottom End Kit w/Oil Seals</b>						
C7908BE			\$75.99	EC1100031F	Inner Clutch Cover	\$23.80	2S2-15462-10-00	
				WP189	Water Pump Cover Gasket	\$8.73	5BE-12439-00-00	
				WA080043C	Water Pump Drain Crush Washer	\$0.57	90430-06014-00	
				WA080043C	Case Oil Galley Drain Plug	\$0.57	90430-06014-00	
				WA116	Case Water Galley Drain Plug	\$3.02	90430-08119-00	
				WA082063C	Drain Plug Crush Seal	\$1.93	90430-10188-00	
				R109B	Oil Pump O-rings	\$1.13	93210-07135-00	
				R011V	Mag Cover Oil Passage O-ring	\$1.13	93210-08003-00	
				R012B	Case Oil Level Plug O-ring	\$0.51	93210-09350-00	
				R013B	Case Oil Galley O-ring	\$1.19	93210-10197-00	
				R113B	Timing Mark O-ring	\$1.19	93210-14369-00	
				R19X2V	Fill Plug O-Ring	\$2.50	93210-19123-00	
				R018V	Primary Cover Oil Passage O-ring	\$1.19	93210-19758-00	
				R12X2V	Output Shaft O-ring	\$1.19	93210-22298-00	
				R121V	Crank End Plug O-ring	\$1.25	93210-27778-00	
				R134B	Oil Pump Cover O-ring	\$1.13	93210-47675-00	
				R141V	Electric Starter Cover O-ring	\$3.08	93210-58346-00	
<b>Oil Seal Kit</b>								
C7908OS			\$29.88	OS227	Inner Water Pump Oil Seal	\$2.67	93102-12321-00	
				OS236	Oil Pump Seal	\$4.23	93101-14164-00	
				OS242	Outer Water Pump Oil Seal	\$3.54	93109-11073-00	
				OS284	Output Shaft Seal	\$5.09	93102-32480-00	
				OS285	Kick Start Shaft Seal	\$1.48	93102-20108-00	
				OS286	Clutch Pushrod Seal	\$4.29	93102-12224-00	
				OS286	Shift Shaft Seal	\$4.29	93102-12224-00	
<b>Clutch &amp; Mag Kit</b>								
C7908CM			\$20.62	EC763020F	Outer Clutch Cover	9.94	5TA-15453-00-00	
				EC1099031F	Mag Cover Gasket	10.68	2S2-15451-00-00	
					<b>Component Part#</b>	<b>List Price</b>	<b>OEM Part #</b>	
				VC104	Valve Cover Gasket	\$23.80		

## YAMAHA YZ490

Model	Year	Bore Size	Top End Kit	List Price	Component Part#	Component Description	List Price	OEM Part #
YZ490	83	89 mm	C7138	\$39.70	H0166043C	Head Gasket	\$25.73	5X6-11181-00-00
					B0063020F	Base Gasket	\$6.25	1LV-11351-00-00
			<b>Top End Kit</b>	<b>List Price</b>	<b>Component Part#</b>	<b>Component Description</b>	<b>List Price</b>	<b>OEM Part #</b>
YZ490	84-86	89 mm	C7090	\$39.70	H0062043C	Head Gasket	\$25.73	40T-11181-00-00
YZ490	87-90				B0063020F	Base Gasket	\$6.25	1LV-11351-00-00
WR500	91-93				IR018018AFM	Intake Gasket	\$3.80	2K7-13621-00-00
			<b>Top End Kit</b>	<b>List Price</b>	<b>Component Part#</b>	<b>Component Description</b>	<b>List Price</b>	<b>OEM Part #</b>
XTT500/ SR500	76-81	90 mm	C7252	\$29.35	H0193043F	Head Gasket	\$27.26	2J2-11181-09-00
					B0188020F	Base Gasket	\$7.16	583-11351-00-00
			<b>Top End Kit</b>	<b>List Price</b>	<b>Component Part#</b>	<b>Component Description</b>	<b>List Price</b>	<b>OEM Part #</b>
TT600 XT, SRX	83-87	98 mm	C7114	\$29.35	H0063043F	Head Gasket	\$22.32	1JK-11181-00
			<b>Top End Kit</b>	<b>List Price</b>	<b>Component Part#</b>	<b>Component Description</b>	<b>List Price</b>	<b>OEM Part #</b>
XT600	88-96	97 mm	C7213	\$29.35	H0267043F	Head Gasket 97mm	\$22.32	2KF-11181-01
		98 mm	C7276	\$29.35	H0320043F	Head Gasket 98mm	\$22.32	2KF-11181-01
		101 mm	C7277	\$29.35	H0321043F	Head Gasket 101mm	\$22.32	2KF-11181-01
					B0064020F	Base Gasket	\$7.16	1VJ-11351-00-00
					B1019010RC	Base Gasket	\$13.62	33D-11351-00-00
					EC019032AFM	Cam Chain Tensioner Gasket	\$2.04	4FM-12213-00-00
					EX1041042AM	Exhaust Gasket	\$4.65	33D-14613-00-00

All Component Parts can be purchased individually.



**WARNING:** Cancer and Reproductive Harm www.P65Warnings.ca.gov



# Water Pump Gaskets



Cometic Gasket - An Exclusive NASCAR Performance® Product

Make/Model	Year	Part#	Retail
<b>HONDA</b>			
CR80R/85R	1992-2007	C7126WP	\$48.15
CRF150	2007-2019	C3187WP	\$43.25
CR125R	1990-2004	C7757WP	\$34.78
CR125R	2005-2007	C3085WP	\$49.26
CR250R	1992-2001	C7116WP	\$34.75
CR250R	2002-2007	C7191WP	\$39.96
CRF250R	2004-2009	C7185WP	\$51.63
CRF250X	2004-2013	C7185WP	\$51.63
CRF250R	2010-2017	C3288WP	\$61.97
CRF450R	2002-2008	C3047WP	\$41.80
CRF450R	2009-2016	C3270WP	\$61.35
CR500R	1987-2001	C7020WP	\$36.91
<b>HUSQVARNA</b>			
TC125	2016-2019	C3606WP	\$50.89
TC150	2016-2019	C3606WP	\$50.89
FC250	2016-2019	C3595WP	\$43.03
FC350	2016-2019	C3595WP	\$43.03
<b>KAWASAKI</b>			
KX65	2000-2019	C7736WP	\$36.18
KX80	1986-2000	C7029WP	\$27.73
KX85	2001-2019	C7029WP	\$27.73
KX100	1995-2016	C7029WP	\$27.73
KX125	1994-2002	C7241WP	\$48.21
KX125	2003-2005	C7921WP	\$47.03
KX250F	2004-2008	C3174WP	\$59.84
KX250F	2009-2016	C3267WP	\$52.22
KX250F	2017-2019	C3619WP	\$53.60
KX450F	2006-2008	C3136WP	\$43.97
KX450F	2009-2015	C3268WP	\$43.97
KX450F	2016-2017	C3598WP	\$45.08
KLX450R	2008-2014	C3136WP	\$43.97
<b>KTM</b>			
50SX	2009-2016	C3503WP	\$49.78
65SX	2009-2016	C3416WP	\$48.42
85SX	2003-2016	C7384WP	\$40.54
105SX	2004-2011	C7384WP	\$40.54
150SX	2016-2019	C3606WP	\$50.89
125SX	2016-2019	C3606WP	\$50.89
250 SX-F Factory	2016-2019	C3595WP	\$43.03
350 SX-F Factory	2016-2019	C3595WP	\$43.03

Make/Model	Year	Part#	Retail
<b>SUZUKI</b>			
RM65	2003-2005	C7736WP	\$36.18
RM85	2002-2015	C7857WP	\$31.33
RM100	2003	C7029WP	\$27.73
RM125	2001-2003	C7778WP	\$44.86
RM125	2004-2007	C7508WP	\$44.19
RM250	2001-2002	C7799WP	\$32.89
RM250	2003-2008	C7467WP	\$32.22
RM-Z250	2004-2006	C3174WP	\$59.84
RM-Z250	2007-2015	C3175WP	\$56.52
RM-Z450	2005-2007	C3102WP	\$64.24
RM-Z450	2008-2016	C3233WP	\$55.89
<b>YAMAHA</b>			
YZ80	1993-2001	C7137WP	\$37.29
YZ85	2002-2015	C7851WP	\$41.16
YZ125	2005-2016	C3105WP	\$43.14
YZ125	1998-2004	C7399WP	\$31.38
YZ125	1994-1997	C7158WP	\$27.51
YZ250	1999-2016	C7507WP	\$33.43
WR250F	2001-2013	C3057WP	\$33.68
YZ250F	2001-2013	C3057WP	\$33.68
YZ250F	2014-2017	C3549WP	\$41.87
WR400F	1998-2000	C7400WP	\$38.47
YZ400F	1998-1999	C7400WP	\$38.47
YZ426F	2000-2002	C7689WP	\$38.47
WR426F	2001-2002	C7689WP	\$38.47
WR450F	2003-2006	C3560WP	\$38.47
WR450F	2007-2015	C7908WP	\$38.47
WR450F	2016	C3340WP	\$45.89
YZ450F	2003-2005	C3540WP	\$38.47
YZ450F	2006-2009	C7908WP	\$38.47
YZ450F	2010-2013	C3395WP	\$42.75
YZ450F	2014-2017	C3340WP	\$45.89

All Component Parts can be purchased individually.

**WARNING:** Cancer and Reproductive Harm [www.P65Warnings.ca.gov](http://www.P65Warnings.ca.gov)



# STREET-ROAD RACE-STRIP



Cometic Gasket - An Exclusive NASCAR Performance® Product

## APRILLA

Model	Year	Head Gasket Part#	Bore	Material/Thickness	Price	Base Gasket Part#	Bore	Material/Thickness	Price	Case Kit Part#	Price
RSV1000R Mille	98-06	C8511-018	98mm	MLS/C.O.T. .018"	\$110.84						
RSV1000R Mille	98-06	C8512-018	100mm	MLS/C.O.T. .018"	\$110.84						

## DUCATI

748	94-02	C8753	88mm	MLS/C.O.T. .030"	\$71.55	C8754	.020"	\$39.75			
851	87-81	C8560	91mm	MLS/C.O.T. .018"	\$66.33	C8755	.020"	\$31.80			
851	87-81	C8564	96mm	MLS/C.O.T. .018"	\$66.33	C8755	.020"	\$31.80			
888	91-98	C8564	96mm	MLS/C.O.T. .018"	\$66.33	C8755	.020"	\$31.80			
916	91-98	C8564	96mm	MLS/C.O.T. .018"	\$66.33	C8755	.020"	\$31.80			
996	99-02	C8561	98mm	MLS/C.O.T. .018"	\$66.33	C8756	.014"	\$23.29			
996R	2001	C8757	100mm	MLS/C.O.T. .027"	\$173.54						
996R	2001	C8758	102mm	MLS/C.O.T. .027"	\$173.54						
1000 GS Super Sport	89-07	C8700	98mm	SLS .010"	\$47.64	C8759	.014"	\$18.96			
1098, 1098S	07-08	C8807		MLS/C.O.T. .027"	\$83.43	C8809	.014"	\$26.37			
1198, 1198S, 1198R	09-11	C8808	106mm	MLS/C.O.T. .027"	\$83.43	C8809	.014"	\$26.37			
Panigale 1199	12-13	C8834	113mm	MLS/C.O.T. .020"	\$83.43						
Panigale 1199	12-13	C8835	116mm	MLS/C.O.T. .020"	\$83.43						

## HONDA

Model	Year	Bore Size	EST Top End Kit	List Price	Component Description
CBR250	11-15	77mm	C3522-EST	\$58.95	MLS/C.O.T. .027" Head, Base, Exhaust, Cam Chain Tensioner Gaskets, and Valve Seals
		78mm	C3523-EST		
		80mm	C3524-EST		
		81mm	C8832-EST		
		83mm	C3526-EST		
MSX125 Grom	14-19	52.4mm	C8915	\$42.19	Head, Base, Exhaust, Cam Chain Tensioner Gaskets, and Valve Seals

## HONDA

Model	Year	Head Gasket Part#	Bore	Material/Thickness	Price	Base Gasket Part#	Bore	Material/Thickness	Price	Case Kit Part#	Price
CB500	72-74	C8824	59mm	MLS/C.O.T. .040"	\$87.73						
CB500	72-74	C8825	60mm	MLS/C.O.T. .040"	\$87.73						
CB500	72-74	C8826	61mm	MLS/C.O.T. .040"	\$87.73						
CB500	72-74	C8827	62mm	MLS/C.O.T. .040"	\$87.73						
CB500	13-15	C8887	69mm	MLS/C.O.T. .023"	\$37.68						
CB500	13-15	C8888	70mm	MLS/C.O.T. .023"	\$37.68						
CB550	74-78	C8824	59mm	MLS/C.O.T. .040"	\$87.73						
CB550	74-78	C8825	60mm	MLS/C.O.T. .040"	\$87.73						
CB550	74-78	C8826	61mm	MLS/C.O.T. .040"	\$87.73						
CB550	74-78	C8827	62mm	MLS/C.O.T. .040"	\$87.73						
CB650	79-82	C8824	59mm	MLS/C.O.T. .040"	\$87.73						
CB650	79-82	C8825	60mm	MLS/C.O.T. .040"	\$87.73						
CB650	79-82	C8826	61mm	MLS/C.O.T. .040"	\$87.73						
CB650	79-82	C8827	62mm	MLS/C.O.T. .040"	\$87.73						
CBR600	91-98	C8265	67mm	MLS/C.O.T. .030"	\$87.73					C8301	\$28.67
CBR600	91-98	C8265-018	67mm	MLS/C.O.T. .018"	\$100.22					C8301	\$28.67
CBR600 F2	91-94	C8265	67mm	MLS/C.O.T. .030"	\$87.73						
CBR600 F2	91-94	C8265-018	67mm	MLS/C.O.T. .018"	\$100.22						
CBR600 F3	95-98	C8265	67mm	MLS/C.O.T. .030"	\$87.73						
CBR600 F3	95-98	C8265-018	67mm	MLS/C.O.T. .018"	\$100.22						
CBR600 F4	99-06	C8572	67mm	MLS/C.O.T. .030"	\$87.73					C8633	\$41.79
CBR600 F4	99-06	C8572-018	67mm	MLS/C.O.T. .018"	\$100.22					C8633	\$41.79
CBR600 F4	99-06	C8636	68mm	MLS/C.O.T. .030"	\$87.73					C8633	\$41.79
CBR600 F4	99-06	C8671	69mm	MLS/C.O.T. .030"	\$87.73					C8633	\$41.79
CBR600 RR	03-06	C8704-018	67mm	MLS/C.O.T. .018"	\$100.22						
CBR600 RR	03-06	C8704-027	67mm	MLS/C.O.T. .027"	\$87.73						
CBR600 RR	03-06	C8705-018	70mm	MLS/C.O.T. .018"	\$100.22						
CBR600 RR	03-06	C8705-027	70mm	MLS/C.O.T. .027"	\$87.73						









# STREET·ROAD RACE·STRIP



Cometic Gasket - An Exclusive NASCAR Performance® Product

## HONDA

Model	Year	Head Gasket Part#	Bore	Material/Thickness	Price	Base Gasket Part#	Bore	Material/Thickness	Price	Case Kit Part#	Price
CBR600 RR	03-06	C8706-018	69mm	MLS/C.O.T. .018"	\$100.22						
CBR600 RR	03-06	C8706-027	69mm	MLS/C.O.T. .027"	\$87.73						
CBR600 RR	07-18	C8736	68.5mm	MLS/C.O.T. .027"	\$83.52					C8739	\$41.79
CBR600 RR	07-19	C8736-018	68.5mm	MLS/C.O.T. .018"	\$94.88					C8739	\$41.79
CBR600 RR	07-19	C8737	70mm	MLS/C.O.T. .027"	\$83.52					C8739	\$41.79
CBR600 RR	07-19	C8737-018	70mm	MLS/C.O.T. .018"	\$94.88					C8739	\$41.79
CBR600F Hurricane	87-90	C8000	65mm	.020" Copper	\$65.64	C8503		.010" Copper	\$35.38		
CBR600F Hurricane	87-90					C8504		.020" Copper	\$35.38		
NT650 Hawk GT	88-91	C8207	82mm	SLS .010"	\$54.34	C8520		.010" Copper	\$30.72		
CB750 2 Valve	71-78	C8001	65mm	CFM-20 .043"	\$54.34					C8863	\$45.99
CB750 2 Valve	71-78	C8002	67.5mm	CFM-20 .043"	\$54.34					C8863	\$45.99
CB750K 2V	73-78	C8801	65mm	MLS/C.O.T. .045"	\$63.94	C8286		.005" Copper	\$35.38	C8863	\$45.99
CB750K 2V	73-78	C8801	65mm	MLS/C.O.T. .045"	\$63.94	C8287		.010" Copper	\$35.38	C8863	\$45.99
CB750K 2V	73-78	C8801	65mm	MLS/C.O.T. .045"	\$63.94	C8288		.020" Copper	\$35.38	C8863	\$45.99
CB750K 2V	73-78	C8801	65mm	MLS/C.O.T. .045"	\$63.94	C8289		.020" Fiber	\$13.97	C8863	\$45.99
CB750K 2V	73-78	C8802	68mm	MLS/C.O.T. .045"	\$63.94	C8286		.005" Copper	\$35.38	C8863	\$45.99
CB750K 2V	73-78	C8802	68mm	MLS/C.O.T. .045"	\$63.94	C8287		.010" Copper	\$35.38	C8863	\$45.99
CB750K 2V	73-78	C8802	68mm	MLS/C.O.T. .045"	\$63.94	C8288		.020" Copper	\$35.38	C8863	\$45.99
CB750K 2V	73-78	C8802	68mm	MLS/C.O.T. .045"	\$63.94	C8289		.020" Fiber	\$13.97	C8863	\$45.99
CB750K 2V	73-78	C8803	70mm	MLS/C.O.T. .045"	\$63.94	C8286		.005" Copper	\$35.38	C8863	\$45.99
CB750K 2V	73-78	C8803	70mm	MLS/C.O.T. .045"	\$63.94	C8287		.010" Copper	\$35.38	C8863	\$45.99
CB750K 2V	73-78	C8803	70mm	MLS/C.O.T. .045"	\$63.94	C8288		.020" Copper	\$35.38	C8863	\$45.99
CB750K 2V	73-78	C8803	70mm	MLS/C.O.T. .045"	\$63.94	C8289		.020" Fiber	\$13.97	C8863	\$45.99
CB750K 2V	73-78	C8804	72mm	MLS/C.O.T. .045"	\$63.94	C8286		.005" Copper	\$35.38	C8863	\$45.99
CB750K 2V	73-78	C8804	72mm	MLS/C.O.T. .045"	\$63.94	C8287		.010" Copper	\$35.38	C8863	\$45.99
CB750K 2V	73-78	C8804	72mm	MLS/C.O.T. .045"	\$63.94	C8288		.020" Copper	\$35.38	C8863	\$45.99
CB750K 2V	73-78	C8804	72mm	MLS/C.O.T. .045"	\$63.94	C8289		.020" Fiber	\$13.97	C8863	\$45.99
CB750L,F,K,C,SC 4V DOHC	79-83	C8003	65mm	Fiber .043"	\$54.34	C8451	74mm	.005" Copper	\$35.38		
CB750L,F,K,C,SC 4V DOHC	79-83	C8003	65mm	Fiber .043"	\$54.34	C8452	74mm	.010" Copper	\$33.68		
CB750L,F,K,C,SC 4V DOHC	79-83	C8003	65mm	Fiber .043"	\$54.34	C8453	74mm	.020" Copper	\$33.68		
CB750L,F,K,C,SC 4V DOHC	79-83	C8003	65mm	Fiber .043"	\$54.34	C8454	74mm	.020" Fiber	\$13.29		
CB750L,F,K,C,SC 4V DOHC	79-83	C8004	70mm	Fiber .043"	\$54.34	C8451	74mm	.005" Copper	\$35.38		
CB750L,F,K,C,SC 4V DOHC	79-83	C8004	70mm	Fiber .043"	\$54.34	C8452	74mm	.010" Copper	\$33.68		
CB750L,F,K,C,SC 4V DOHC	79-83	C8004	70mm	Fiber .043"	\$54.34	C8453	74mm	.020" Copper	\$33.68		
CB750L,F,K,C,SC 4V DOHC	79-83	C8004	70mm	Fiber .043"	\$54.34	C8454	74mm	.020" Fiber	\$13.29		
VFR750	90-94	C8498	72mm	Fiber .043"	\$54.34						
CB900F Super Sport	81-82	C8005	68mm	Fiber .043"	\$54.34	C8451	74mm	.005" Copper	\$35.38		
CB900F Super Sport	81-82	C8005	68mm	Fiber .043"	\$54.34	C8452	74mm	.010" Copper	\$33.68		
CB900F Super Sport	81-82	C8005	68mm	Fiber .043"	\$54.34	C8453	74mm	.020" Copper	\$33.68		
CB900F Super Sport	81-82	C8005	68mm	Fiber .043"	\$54.34	C8454	74mm	.020" Fiber	\$13.29		
CB900F Super Sport	81-82	C8224	72mm	Copper .043"	\$65.64	C8451	74mm	.005" Copper	\$35.38		
CB900F Super Sport	81-82	C8224	72mm	Copper .043"	\$65.64	C8452	74mm	.010" Copper	\$33.68		
CB900F Super Sport	81-82	C8224	72mm	Copper .043"	\$65.64	C8453	74mm	.020" Copper	\$33.68		
CB900F Super Sport	81-82	C8224	72mm	Copper .043"	\$65.64	C8454	74mm	.020" Fiber	\$13.29		
CB900C 900 Custom	80-82	C8005	68mm	Fiber .043"	\$54.34	C8451	74mm	.005" Copper	\$35.38		
CB900C 900 Custom	80-82	C8005	68mm	Fiber .043"	\$54.34	C8452	74mm	.010" Copper	\$33.68		
CB900C 900 Custom	80-82	C8005	68mm	Fiber .043"	\$54.34	C8453	74mm	.020" Copper	\$33.68		
CB900C 900 Custom	80-82	C8005	68mm	Fiber .043"	\$54.34	C8454	74mm	.020" Fiber	\$13.29		
CB900C 900 Custom	80-82	C8224	72mm	Copper .043"	\$65.64	C8451	74mm	.005" Copper	\$35.38		
CB900C 900 Custom	80-82	C8224	72mm	Copper .043"	\$65.64	C8452	74mm	.010" Copper	\$33.68		
CB900C 900 Custom	80-82	C8224	72mm	Copper .043"	\$65.64	C8453	74mm	.020" Copper	\$33.68		
CB900C 900 Custom	80-82	C8224	72mm	Copper .043"	\$65.64	C8454	74mm	.020" Fiber	\$13.29		
CBR900	93-99	C8267	72mm	MLS/C.O.T. .040"	\$83.52					C8211	\$39.80
CBR900	93-99	C8267-018	72mm	MLS/C.O.T. .018"	\$95.45					C8211	\$39.80
CBR900	93-99	C8268	74mm	MLS/C.O.T. .040"	\$87.73					C8211	\$39.80
CBR900	93-99	C8268-018	74mm	MLS/C.O.T. .018"	\$95.45					C8211	\$39.80
CBR900	93-99	C8401	73mm	MLS/C.O.T. .040"	\$83.52					C8211	\$39.80
CBR900	93-99	C8401-018	73mm	MLS/C.O.T. .018"	\$95.45					C8211	\$39.80
CBR900	93-99	C8406	75mm	MLS/C.O.T. .040"	\$83.52					C8211	\$39.80
CBR900	93-99	C8406-018	75mm	MLS/C.O.T. .018"	\$95.45					C8211	\$39.80
919 (CB900F)	02-07	C8267	72mm	MLS/C.O.T. .040"	\$83.52					C8211	\$39.80
919 (CB900F)	02-07	C8267-018	72mm	MLS/C.O.T. .018"	\$95.45					C8211	\$39.80
919 (CB900F)	02-07	C8268	74mm	MLS/C.O.T. .040"	\$87.73					C8211	\$39.80





# STREET-ROAD RACE-STRIP



Cometic Gasket - An Exclusive NASCAR Performance® Product

## HONDA

Model	Year	Head Gasket Part#	Bore	Material/Thickness	Price	Base Gasket Part#	Bore	Material/Thickness	Price	Case Kit Part#	Price
919 (CB900F)	02-07	C8268-018	74mm	MLS/C.O.T. .018"	\$95.45					C8211	\$39.80
919 (CB900F)	02-07	C8401	73mm	MLS/C.O.T. .040"	\$83.52					C8211	\$39.80
919 (CB900F)	02-07	C8401-018	73mm	MLS/C.O.T. .018"	\$95.45					C8211	\$39.80
919 (CB900F)	02-07	C8406	75mm	MLS/C.O.T. .040"	\$83.52					C8211	\$39.80
919 (CB900F)	02-07	C8406-018	75mm	MLS/C.O.T. .018"	\$95.45					C8211	\$39.80
CBR929	00-01	C8568	76mm	MLS/C.O.T. .030"	\$87.73					C8634	\$41.79
CBR929	00-01	C8568-018	76mm	MLS/C.O.T. .018"	\$100.22					C8634	\$41.79
CBR954	02-03	C8568	76mm	MLS/C.O.T. .030"	\$87.73					C8634	\$41.79
CBR954	02-03	C8568-018	76mm	MLS/C.O.T. .018"	\$100.22					C8634	\$41.79
CBR1000	87-95	C8008	79mm	Stainless .010"	\$87.73	C8410	84.5mm	.005" Copper	\$35.38		
CBR1000 RR	04-07	C8702-018	75mm	MLS/C.O.T. .018"	\$100.22						
CBR1000 RR	04-07	C8702-027	75mm	MLS/C.O.T. .027"	\$87.73						
CBR1000 RR	04-07	C8703-018	76mm	MLS/C.O.T. .018"	\$100.22						
CBR1000 RR	04-07	C8703-027	76mm	MLS/C.O.T. .027"	\$87.73						
CBR1000 RR	04-07	C8727	77mm	MLS/C.O.T. .027"	\$87.73						
CBR1000 RR	04-07	C8727-018	77mm	MLS/C.O.T. .018"	\$100.22						
CBR1000 RR	08-19	C8779	77mm	MLS/C.O.T. .027"	\$87.73	C8780		.010" RC	\$29.24		
CBR1000 RR	08-19	C8779-018	77mm	MLS/C.O.T. .018"	\$100.22	C8780		.010" RC	\$29.24		
RVT1000R/RC51	00-06	C8766	103.5mm	MLS/C.O.T. .027"	\$83.52						
RVT1000R/RC51	00-06	C8569	101.5mm	MLS/C.O.T. .027"	\$83.52						
RVT1000R/RC51	00-06	C8765	102.5mm	MLS/C.O.T. .027"	\$83.52						
CB1100F	83-83	C8006	72mm	Fiber .043"	\$54.34	C8521	79.5mm	.020" Copper	\$35.38		
CB1100F	83-83	C8007	75mm	.020" Copper	\$59.46	C8521	79.5mm	.020" Copper	\$35.38		
CB1100F	83-83	C8224	72mm	Copper .043"	\$65.64	C8521	79.5mm	.020" Copper	\$35.38		
CB1100F	83-83	C8225	74mm	Copper .043"	\$62.51	C8521	79.5mm	.020" Copper	\$35.38		
CBR1100XX Blackbird	97-03	C8499	81mm	MLS/C.O.T. .030"	\$87.73					C8586	\$46.00
CBR1100XX Blackbird	97-03	C8499-018	81mm	MLS/C.O.T. .018"	\$95.45					C8586	\$46.00
CBX 6 Cylinder	79-82	C8319	67.5mm	Copper .043	\$96.19	C8342		.020" Fiber	\$26.51		
CBX 6 Cylinder	79-82	C8341	68mm	Fiber .043"	\$83.65	C8342		.020" Fiber	\$26.51		
CBX 6 Cylinder	79-82	C8396	65mm	Copper .043	\$96.19	C8342		.020" Fiber	\$26.51		
CBX 6 Cylinder	79-82	C8407	65mm	Fiber .043"	\$83.65	C8342		.020" Fiber	\$26.51		

## HUSQVARNA

Model	Year	Head Gasket Part#	Bore	Material/Thickness	Price	Base Gasket Part#	Bore	Material/Thickness	Price	Case Kit Part#	Price
Vitpilen 401	18	89mm	MLS/C.O.T. .027"	C8897	\$33.23	C8899		.014" RC Steel	\$11.87		
Vitpilen 401	18	91mm	MLS/C.O.T. .027"	C8898	\$33.23	C8899		.014" RC Steel	\$11.87		
Svartpilen 401	18	89mm	MLS/C.O.T. .027"	C8897	\$33.23	C8899		.014" RC Steel	\$11.87		
Svartpilen 401	18	91mm	MLS/C.O.T. .027"	C8898	\$33.23	C8899		.014" RC Steel	\$11.87		

## KAWASAKI

Model	Year	Head Gasket Part#	Bore	Material/Thickness	Price	Base Gasket Part#	Bore	Material/Thickness	Price	Case Kit Part#	Price
919 (CB900F)	02-07	C8406	75mm	MLS/C.O.T. .040"	\$83.52					C8211	\$39.80
EX250 Ninja	86-07	C8828	62mm	SLS .012"	\$31.47						
EX250 Ninja	86-07	C8829	64mm	SLS .012"	\$31.47						
EX250 Ninja	08-12	C8859	62mm	SLS .012"	\$31.47						
EX250 Ninja	08-12	C8860	64mm	SLS .012"	\$31.47						
EX250 Ninja	08-12	C8861	66mm	SLS .012"	\$31.47						
Ninja 400 EX400	18	C8938	70mm	MLS/C.O.T. .018"	\$51.73						
Ninja 500,500R,EX500	87-09	C8318	75.5mm	CFM-20 .043"	\$51.68						
GP, GPz 550	81-85	C8009	61mm	Fiber .043"	\$54.34						
Zeyphr 550	90-91	C8009	61mm	Fiber .043"	\$54.34						
KZ 550 Ltd.	80-83	C8009	61mm	Fiber .043"	\$54.34						
Ninja 600R ZX600	87-94	C8010	62mm	Fiber .043"	\$51.73	C8589	2.680"	.005" Copper	\$33.68		
Ninja ZX-6R	95-02	C8270	68mm	MLS/C.O.T. .030"	\$83.52	C8698		.010" RC	\$29.26	C8303	\$25.50
Ninja ZX-6R	95-02	C8270-018	68mm	MLS/C.O.T. .018"	\$95.45	C8698		.010" RC	\$29.26	C8303	\$25.50
Ninja ZX-6R	00-02	C8693	68mm	MLS/C.O.T. .027"	\$83.52	C8698		.010" RC	\$29.26	C8303	\$25.50
Ninja ZX-6R	00-02	C8693-018	68mm	MLS/C.O.T. .018"	\$95.45	C8698		.010" RC	\$29.26	C8303	\$25.50
Ninja ZX-6R	00-02	C8694	70mm	MLS/C.O.T. .027"	\$83.52	C8698		.010" RC	\$29.26	C8303	\$25.50







# STREET-ROAD RACE-STRIP



Cometic Gasket - An Exclusive NASCAR Performance® Product

## KAWASAKI

Model	Year	Head Gasket Part#	Bore	Material/Thickness	Price	Base Gasket Part#	Bore	Material/Thickness	Price	Case Kit Part#	Price
Ninja ZX-6R	00-02	C8694-018	70mm	MLS/C.O.T. .018"	\$95.45	C8698		.010" RC	\$29.26	C8303	\$25.50
Ninja ZX-6R	03-06	C8690	68mm	MLS/C.O.T. .027"	\$83.52	C8692		.010" RC	\$30.72	C8685	\$54.80
Ninja ZX-6R	03-06	C8690-018	68mm	MLS/C.O.T. .018"	\$95.45	C8692		.010" RC	\$30.72	C8685	\$54.80
Ninja ZX-6R	03-06	C8696	70mm	MLS/C.O.T. .027"	\$83.52	C8692		.010" RC	\$30.72	C8685	\$54.80
Ninja ZX-6R	03-06	C8696-018	70mm	MLS/C.O.T. .018"	\$100.22	C8692		.010" RC	\$30.72	C8685	\$54.80
Ninja ZX-6R	03-06	C8701	69mm	MLS/C.O.T. .027"	\$83.52	C8692		.010" RC	\$30.72	C8685	\$54.80
Ninja ZX-6R	03-06	C8701-018	69mm	MLS/C.O.T. .018"	\$100.22	C8692		.010" RC	\$30.72	C8685	\$54.80
Ninja ZX-6R	07-19	C8751	68mm	MLS/C.O.T. .027"	\$87.73					C8750	\$53.80
Ninja ZX-6R	07-19	C8751-018	68mm	MLS/C.O.T. .018"	\$100.22					C8750	\$53.80
Ninja ZX-6RR	03	C8696	70mm	MLS/C.O.T. .027"	\$83.52	C8692		.010" RC	\$30.72	C8685	\$54.80
Ninja ZX-6RR	03	C8696-018	70mm	MLS/C.O.T. .018"	\$100.22	C8692		.010" RC	\$30.72	C8685	\$54.80
Ninja ZX-6RR	03	C8701	69mm	MLS/C.O.T. .027"	\$83.52	C8692		.010" RC	\$30.72	C8685	\$54.80
Ninja ZX-6RR	03	C8701-018	69mm	MLS/C.O.T. .018"	\$100.22	C8692		.010" RC	\$30.72	C8685	\$54.80
Ninja ZX-6RR	04-06	C8691	68mm	MLS/C.O.T. .027"	\$87.73	C8692		.010" RC	\$30.72	C8685	\$54.80
Ninja ZX-6RR	04-06	C8691-018	68mm	MLS/C.O.T. .018"	\$100.22	C8692		.010" RC	\$30.72	C8685	\$54.80
Ninja ZX-6RR	04-06	C8697	70mm	MLS/C.O.T. .027"	\$87.73	C8692		.010" RC	\$30.72	C8685	\$54.80
Ninja ZX-6RR	04-06	C8697-018	70mm	MLS/C.O.T. .018"	\$100.22	C8692		.010" RC	\$30.72	C8685	\$54.80
ZZR600	05-08	C8694	70mm	MLS/C.O.T. .027"	\$83.52	C8698	2.925"	.010" RC	\$30.72	C8685	\$54.80
ZZR600	05-08	C8694-018	70mm	MLS/C.O.T. .018"	\$95.45	C8354	2.925"	.010" Copper	\$33.68	C8685	\$54.80
EX650 Ninja, KLE650 Versys	06-16	C8722	84mm	MLS/C.O.T. .027"	\$51.73	C8723		.010" RC	\$9.99	C8721	\$29.24
EX650 Ninja, KLE650 Versys	06-16	C8862	86mm	MLS/C.O.T. .027"	\$51.73	C8723		.010" RC	\$9.99	C8721	\$29.24
KZ650	77-83	C8011	65mm	Fiber .043"	\$51.73	B1211020F		.020" Fiber	\$26.21		
KZ, GPZ750, ZX750 Turbo	84-85	C8012	69mm	Fiber .043"	\$54.34	B1211020F		.020" Fiber	\$26.21		
ZX750 Ninja	87-90	C8320	69mm	.010" Copper	\$65.64	C8343	3.110"	.020" Fiber	\$13.29		
ZX-7	91-95	C8274	72mm	MLS/C.O.T. .030"	\$87.73	C8290	3.210"	.005" Copper	\$33.73	C8304	\$21.63
ZX-7	91-95	C8274-018	72mm	MLS/C.O.T. .018"	\$95.45	C8291	3.210"	.010" Copper	\$35.38	C8304	\$21.63
ZX-7	91-95					C8292	3.210"	.020" Copper	\$33.61	C8304	\$21.63
ZX-7	91-95					C8344	3.210"	.010" RC	\$30.72	C8304	\$21.63
ZX-7R	96-03	C8428	73mm	MLS/C.O.T. .030"	\$83.52	C8524		.010" Copper	\$35.38	C8619	\$21.63
ZX-7R	96-03	C8428-018	73mm	MLS/C.O.T. .018"	\$100.22	C8525		.020" Copper	\$33.61	C8619	\$21.63
ZX-7R	96-03	C8429	75mm	MLS/C.O.T. .030"	\$87.73					C8619	\$21.63
ZX-7R	96-03	C8429-018	75mm	MLS/C.O.T. .018"	\$100.22					C8619	\$21.63
ZX-7RR	96-97	C8428	73mm	MLS/C.O.T. .030"	\$83.52	C8524		.010" Copper	\$35.38	C8619	\$21.63
ZX-7RR	96-97	C8428-018	73mm	MLS/C.O.T. .018"	\$100.22	C8525		.020" Copper	\$33.61	C8619	\$21.63
ZX-7RR	96-97	C8429	75mm	MLS/C.O.T. .030"	\$87.73					C8619	\$21.63
ZX-7RR	96-97	C8429-018	75mm	MLS/C.O.T. .018"	\$100.22					C8619	\$21.63
ZX-9R	94-97	C8272	75mm	MLS/C.O.T. .030"	\$87.73	C8290	3.210"	.005" Copper	\$33.73		
ZX-9R	94-97					C8291	3.210"	.010" Copper	\$35.38		
ZX-9R	94-97					C8292	3.210"	.020" Copper	\$33.61		
ZX-9R	94-97					C8344	3.210"	.010" RC	\$30.72		
ZX-9R	98-99	C8515	77mm		\$83.52	C8505		.005" Copper	\$35.38	C8620	\$37.19
ZX-9R	00-01	C8570	77mm	MLS/C.O.T. .027"	\$87.73	C8595		.010" Copper	\$35.38		
ZX-9R	00-01	C8570-018	77mm	MLS/C.O.T. .018"	\$100.22	C8596		.020" Copper	\$35.38		
ZX-9R	00-01	C8609	79mm	MLS/C.O.T. .027"	\$87.73						
ZX-9R	00-01	C8609-018	79mm	MLS/C.O.T. .018"	\$100.22						
ZX-9R	02-03	C8570	77mm	MLS/C.O.T. .027"	\$87.73	C8595		.010" Copper	\$35.38		
ZX-9R	02-03	C8570-018	77mm	MLS/C.O.T. .018"	\$100.22	C8596		.020" Copper	\$35.38		
ZX-9R	02-03	C8609	79mm	MLS/C.O.T. .027"	\$87.73						
ZX-9R	02-03	C8609-018	79mm	MLS/C.O.T. .018"	\$100.22						
KZ1000J 10mm Pin	81-83	C8152	70mm	Copper .043"	\$65.64	C8864	3.210" 70-76mm	.020" Fiber	\$13.29	C8306	\$26.46
KZ1000J 10mm Pin	81-83	C8153	71mm	Copper .043"	\$65.64					C8306	\$26.46
KZ1000J	81-83	C8842-040	71mm	MLS/C.O.T. .040"	83.52					C8306	\$26.46
KZ1000J 10mm Pin	81-83	C8154	72mm	Copper .043"	\$65.64					C8306	\$26.46
KZ1000J	81-83	C8324	72mm 2 pc	Fiber .043"	\$51.73					C8306	\$26.46
KZ1000J	81-83	C8018	72mm	Fiber .043"	\$54.34					C8306	\$26.46
KZ1000J 10mm Pin	81-83	C8181	73mm	Copper .043"	\$65.64					C8306	\$26.46
KZ1000J	81-83	C8843-040	73mm	MLS/C.O.T. .040"	83.52					C8306	\$26.46
KZ1000J	81-83	C8325	74mm 2 pc.	Fiber .043"	\$54.34					C8306	\$26.46
KZ1000J	81-83	C8244	74mm	Copper .043"	\$65.64					C8306	\$26.46
KZ1000J 10mm Pin	81-83	C8182	75mm	Copper .043"	\$65.64					C8306	\$26.46
KZ1000J	81-83	C8017	75mm	Fiber .043"	\$51.73					C8306	\$26.46
KZ1000J	81-83	C8326	76mm 2 pc.	Fiber .043"	\$54.34					C8306	\$26.46
KZ1000J 10mm Pin	81-83	C8156	76mm	Copper .043"	\$65.64					C8306	\$26.46
KZ1000J	81-83	C8844-040	76mm	MLS/C.O.T. .040"	83.52					C8306	\$26.46







# STREET-ROAD RACE-STRIP



Cometic Gasket - An Exclusive NASCAR Performance® Product

## KAWASAKI

Model	Year	Head Gasket Part#	Bore	Material/Thickness	Price	Base Gasket Part#	Bore	Material/Thickness	Price	Case Kit Part#	Price
GPZ1100 10mm Pin	81-82	C8183	77mm	Copper .043"	\$65.64	C8865	3.285" 77-79mm	.020" Fiber	\$13.29	C8306	\$26.46
GPZ1100 10mm Pin	81-82	C8157	78mm	Copper .043"	\$65.64					C8306	\$26.46
GPZ1100	81-82	C8845-040	78mm	MLS/C.O.T. .040"	83.52					C8306	\$26.46
GPZ1100	81-82									C8306	\$26.46
GPZ1100 10mm Pin	81-82	C8158	80mm n	Copper .043"	\$65.64	C8866	3.475" 80-82mm	.020" Fiber	\$13.29	C8306	\$26.46
GPZ1100 10mm Pin	81-82	C8159	82mm	Copper .043"	\$65.64					C8306	\$26.46
GPZ1100 D Dowel Pin	81-82	C8432	82mm	Copper .043"	\$65.64					C8306	\$26.46
GPZ1100	81-82									C8306	\$26.46
GPZ1100 10mm Pin	81-82	C8160	83mm	Copper .043"	\$65.64	C8121	3.560" 83-84mm	.005" Copper	\$33.61	C8306	\$26.46
GPZ1100 D Dowel Pin	81-82	C8433	83mm	Copper .043"	\$65.64	C8122	3.560" 83-84mm	.010" Copper	\$33.61	C8306	\$26.46
GPZ1100 D Dowel Pin	81-82	C8161	84mm	Copper .043"	\$65.64	C8123	3.560" 83-84mm	.020" Copper	\$33.61	C8306	\$26.46
KZ900 10mm Pin	76-77	C8152	70mm	Copper .043"	\$65.64	C8093	3.210" 70-76mm	.020" Fiber	\$13.24	C8072	\$36.96
KZ900 10mm Pin	76-77	C8153	71mm	Copper .043"	\$65.64	C8094	3.210" 70-76mm	.005" Copper	\$33.61	C8072	\$36.96
KZ900	76-77	C8842-040	71mm	MLS/C.O.T. .040"	83.52	C8095	3.210" 70-76mm	.010" Copper	\$33.61	C8072	\$36.96
KZ900 10mm Pin	76-77	C8154	72mm	Copper .043"	\$65.64	C8096	3.210"	.020" Copper	\$33.61	C8072	\$36.96
KZ900	76-77	C8324	72mm 2 pc.	Fiber .043"	\$51.73					C8072	\$36.96
KZ900	76-77	C8018	72mm	Fiber .043"	\$54.34					C8072	\$36.96
KZ900 10mm Pin	76-77	C8181	73mm	Copper .043"	\$65.64					C8072	\$36.96
KZ900	76-77	C8843-040	73mm	MLS/C.O.T. .040"	83.52					C8072	\$36.96
KZ900	76-77	C8325	74mm 2 pc.	Fiber .043"	\$54.34					C8072	\$36.96
KZ900	76-77	C8244	74mm	Copper .043"	\$65.64					C8072	\$36.96
KZ900 10mm Pin	76-77	C8182	75mm	Copper .043"	\$65.64					C8072	\$36.96
KZ900	76-77	C8017	75mm	Fiber .043"	\$51.73					C8072	\$36.96
KZ900	76-77	C8326	76mm 2 pc.	Fiber .043"	\$54.34					C8072	\$36.96
KZ900 10mm Pin	76-77	C8156	76mm	Copper .043"	\$65.64					C8072	\$36.96
KZ900	76-77	C8841-040	76mm	MLS/C.O.T. .040"	83.52					C8072	\$36.96
KZ900 10mm Pin	76-77	C8183	77mm	Copper .043"	\$65.64	C8097	3.285" 77-79mm	.020" Fiber	\$13.24	C8072	\$36.96
KZ900 10mm Pin	76-77	C8157	78mm	Copper .043"	\$65.64	C8098	3.285" 77-79mm	.005" Copper	\$33.61	C8072	\$36.96
KZ900	76-77	C8845-040	78mm	MLS/C.O.T. .040"	83.52	C8099	3.285" 77-79mm	.010" Copper	\$33.61	C8072	\$36.96
KZ900	76-77					C8100	3.285" 77-79mm	.020" Copper	\$33.61	C8072	\$36.96
KZ900 10mm Pin	76-77	C8158	80mm	Copper .043"	\$65.64	C8101	3.475" 80-82mm	.020" Fiber	\$13.23	C8072	\$36.96
KZ900 10mm Pin	76-77	C8159	82mm	Copper .043"	\$65.64	C8102	3.475" 80-82mm	.005" Copper	\$33.61	C8072	\$36.96
KZ900D Dowel Pin	76-77	C8432	82mm	Copper .043"	\$65.64	C8103	3.475" 80-82mm	.010" Copper	\$33.61	C8072	\$36.96
KZ900	76-77					C8104	3.475" 80-82mm	.020" Copper	\$33.61	C8072	\$36.96
KZ900 10mm Pin	76-77	C8160	83mm	Copper .043"	\$65.64	C8121	3.560" 83-84mm	.005" Copper	\$33.61	C8072	\$36.96
KZ900 D Dowel Pin	76-77	C8433	83mm	Copper .043"	\$65.64	C8122	3.560"	.010" Copper	\$33.61	C8072	\$36.96
KZ900 D Dowel Pin	76-77	C8161	84mm	Copper .043"	\$65.64	C8123	3.560" 83-84mm	.020" Copper	\$33.61	C8072	\$36.96
Z1 10mm Pin	73-75	C8152	70mm	Copper .043"	\$65.64	C8093	3.210" 70-76mm	.020" Fiber	\$13.24	C8072	\$36.96
Z1 10mm Pin	73-75	C815371mm	71mm	Copper .043"	\$65.64	C8094	3.210" 70-76mm	.005" Copper	\$33.61	C8072	\$36.96
Z1	73-75	C8842-040	71mm	MLS/C.O.T. .040"	83.52	C8095	3.210" 70-76mm	.010" Copper	\$33.61	C8072	\$36.96
Z1 10mm Pin	73-75	C8154	72mm	Copper .043"	\$65.64	C8096	3.210" 70-76mm	.020" Copper	\$33.61	C8072	\$36.96







# STREET-ROAD RACE-STRIP



Cometic Gasket - An Exclusive NASCAR Performance® Product

## KAWASAKI

Model	Year	Head Gasket Part#	Bore	Material/Thickness	Price	Base Gasket Part#	Bore	Material/Thickness	Price	Case Kit Part#	Price
KZ1000	79-80	C8324	72mm 2 pc.	Fiber .043"	\$51.73					C8072	\$36.96
KZ1000	79-80	C8018	72mm	Fiber .043"	\$54.34					C8072	\$36.96
KZ1000 10mm Pin	79-80	C8181	73mm	Fiber .043"	\$65.64					C8072	\$36.96
KZ1000	79-80	C8843-040	73mm	MLS/C.O.T. .040"	83.52					C8072	\$36.96
KZ1000	79-80	C8325	74mm 2 pc.	Fiber .043"	\$54.34					C8072	\$36.96
KZ1000	79-80	C8244	74mm	Copper .043"	\$65.64					C8072	\$36.96
KZ1000 10mm Pin	79-80	C8182	75mm	Copper .043"	\$65.64					C8072	\$36.96
KZ1000	79-80	C8017	75mm	Fiber .043"	\$51.73					C8072	\$36.96
KZ1000	79-80	C8326	76mm 2 pc.	Fiber .043"	\$54.34					C8072	\$36.96
KZ1000 10mm Pin	79-80	C8156	76mm	Copper .043"	\$65.64					C8072	\$36.96
KZ1000	79-80	C8844-040	76mm	MLS/C.O.T. .040"	83.52					C8072	\$36.96
KZ1000 10mm Pin	79-80	C8183	77mm	Copper .043"	\$65.64	C8097	3.285" 77-79mm	.020" Fiber	\$13.24	C8072	\$36.96
KZ1000 10mm Pin	79-80	C8157	78mm	Copper .043"	\$65.64	C8098	3.285" 77-79mm	.005" Copper	\$32.02	C8072	\$36.96
KZ1000	79-80	C8845-040	78mm	MLS/C.O.T. .040"	83.52	C8099	3.285" 77-79mm	.010" Copper	\$32.02	C8072	\$36.96
KZ1000	79-80					C8100	3.285" 77-79mm	.020" Copper	\$32.02	C8072	\$36.96
KZ1000 10mm Pin	79-80	C8158	80mm	Copper .043"	\$65.64	C8101	3.475" 80-82mm	.020" Fiber	\$13.23	C8072	\$36.96
KZ1000 10mm Pin	79-80	C8159	82mm	Copper .043"	\$65.64	C8102	3.475" 80-82mm	.005" Copper	\$33.61	C8072	\$36.96
KZ1000 D Dowel Pin	79-80	C8432	82mm	Copper .043	\$65.64	C8103	3.475" 80-82mm	.010" Copper	\$33.61	C8072	\$36.96
KZ1000	77-78					C8104	3.475" 80-82mm	.020" Copper	\$33.61	C8072	\$36.96
KZ1000 10mm Pin	77-78	C8160	83mm	Copper .043"	\$65.64	C8121	3.560" 83-84mm	.005" Copper	\$33.61	C8072	\$36.96
KZ1000 D Dowel Pin	77-78	C8433	83mm D	Copper .043	\$65.64	C8122	3.560" 83-84mm	.010" Copper	\$33.61	C8072	\$36.96
KZ1000 D Dowel Pin	77-78	C8161	84mm	Copper .043	\$65.64	C8123	3.560" 83-84mm	.020" Copper	\$33.61	C8072	\$36.96
KZ1000 10mm Pin	79-80	C8152	70mm	Copper .043"	\$65.64	C8093	3.210" 83-84mm	.020" Fiber	\$13.24	C8072	\$36.96
KZ1000 10mm Pin	79-80	C8153	71mm	Copper .043"	\$65.64	C8094	3.210" 70-76mm	.005" Copper	\$33.61	C8072	\$36.96
KZ1000	79-80	C8842-040	71mm	MLS/C.O.T. .040"	83.52	C8095	3.210" 70-76mm	.010" Copper	\$33.61	C8072	\$36.96
KZ1000 10mm Pin	79-80	C8154	72mm	Copper .043"	\$65.64	C8096	3.210" 70-76mm	.020" Copper	\$33.61	C8072	\$36.96
KZ1000	79-80	C8324	72mm 2 pc.	Fiber .043"	\$51.73					C8072	\$36.96
KZ1000	79-80	C8018	72mm	Fiber .043"	\$54.34					C8072	\$36.96
KZ1000 10mm Pin	79-80	C8181	73mm	Fiber .043"	\$65.64					C8072	\$36.96
KZ1000	79-80	C8843-040	73mm	MLS/C.O.T. .040"	83.52					C8072	\$36.96
KZ1000	79-80	C8325	74mm 2 pc.	Fiber .043"	\$54.34					C8072	\$36.96
KZ1000	79-80	C8244	74mm	Copper .043"	\$65.64					C8072	\$36.96
KZ1000 10mm Pin	79-80	C8182	75mm	Copper .043"	\$65.64					C8072	\$36.96
KZ1000	79-80	C8017	75mm	Fiber .043"	\$51.73					C8072	\$36.96
KZ1000	79-80	C8326	76mm 2 pc.	Fiber .043"	\$54.34					C8072	\$36.96
KZ1000 10mm Pin	79-80	C8156	76mm	Copper .043"	\$65.64					C8072	\$36.96
KZ1000	79-80	C8844-040	76mm	MLS/C.O.T. .040"	83.52					C8072	\$36.96
KZ1000 10mm Pin	79-80	C8183	77mm	Copper .043"	\$65.64	C8097	3.285" 77-79mm	.020" Fiber	\$13.24	C8072	\$36.96
KZ1000 10mm Pin	79-80	C8157	78mm	Copper .043"	\$65.64	C8098	3.285" 77-79mm	.005" Copper	\$32.02	C8072	\$36.96
KZ1000	79-80	C8845-040	78mm	MLS/C.O.T. .040"	83.52	C8099	3.285" 77-79mm	.010" Copper	\$32.02	C8072	\$36.96
KZ1000	79-80					C8100	3.285" 77-79mm	.020" Copper	\$32.02	C8072	\$36.96
KZ1000 10mm Pin	79-80	C8158	80mm	Copper .043"	\$65.64	C8101	3.475" 80-82mm	.020" Fiber	\$13.23	C8072	\$36.96
KZ1000 10mm Pin	79-80	C8159	82mm	Copper .043"	\$65.64	C8102	3.475" 80-82mm	.005" Copper	\$33.61	C8072	\$36.96
KZ1000 D Dowel Pin	79-80	C8432	82mm	Copper .043	\$65.64	C8103	3.475" 80-82mm	.010" Copper	\$33.61	C8072	\$36.96







# STREET-ROAD RACE-STRIP



Cometic Gasket - An Exclusive NASCAR Performance® Product

## KAWASAKI

Model	Year	Head Gasket Part#	Bore	Material/Thickness	Price	Base Gasket Part#	Bore	Material/Thickness	Price	Case Kit Part#	Price
KZ1000	79-80					C8104	3.475" 80-82mm	.020" Copper	\$33.61	C8072	\$36.96
KZ1000 10mm Pin	79-80	C8160	83mm	Copper .043"	\$65.64	C8121	3.560" 83-84mm	.005" Copper	\$33.61	C8072	\$36.96
KZ1000 D Dowel Pin	79-80	C8433	83mm	Copper .043	\$65.64	C8122	3.560" 83-84mm	.010" Copper	\$33.61	C8072	\$36.96
KZ1000 D Dowel Pin	79-80	C8161	84mm	Copper .043	\$65.64	C8123	3.560" 83m-84mm	.020" Copper	\$33.61	C8072	\$36.96
Ninja 1000R ZX1000	86-87	C8013	75mm	CFM-20	\$54.34	C8346	3.230"	.010"RC	\$30.72	C8305AFM	\$25.50
Z1000 (ZR1000)	03-09	C8708-018	79mm	MLS/C.O.T. .018"	\$83.19						
Z1000 (ZR1000)	03-09	C8709-018	81mm	MLS/C.O.T. .018"	\$83.19						
ZX1000 Ninja, ZX10	88-90	C8271	75.5mm	MLS/C.O.T. .030"	\$87.73						
ZX1000 Ninja ZX-10R	04-05	C8680	76mm	MLS/C.O.T. .027"	\$87.73					C8682	\$39.80
ZX1000 Ninja ZX-10R	04-05	C8680-018	76mm	MLS/C.O.T. .018"	\$95.45					C8682	\$39.80
ZX1000 Ninja ZX-10R	04-05	C8681	78mm	MLS/C.O.T. .027"	\$87.73					C8682	\$39.80
ZX1000 Ninja ZX-10R	04-05	C8681-018	78mm	MLS/C.O.T. .018"	\$95.45					C8682	\$39.80
ZX1000 Ninja ZX-10R	06-07	C8714	76mm	MLS/C.O.T. .027"	\$87.73					C8715	\$54.80
ZX1000 Ninja ZX-10R	06-07	C8714-018	76mm	MLS/C.O.T. .018"	\$95.45					C8715	\$54.80
ZX1000 Ninja ZX-10R	06-07	C8576	78mm	MLS/C.O.T. .027"	\$87.73					C8715	\$54.80
ZX1000 Ninja ZX-10R	06-07	C8576-018	78mm	MLS/C.O.T. .018"	\$95.45					C8715	\$54.80
ZX1000 Ninja ZX-10R	08-10	C8714	76mm	MLS/C.O.T. .027"	\$87.73					C8715	\$54.80
ZX1000 Ninja ZX-10R	08-10	C8714-018	76mm	MLS/C.O.T. .018"	\$95.45					C8715	\$54.80
ZX1000 Ninja ZX-10R	08-10	C8576	78mm	MLS/C.O.T. .027"	\$87.73					C8715	\$54.80
ZX1000 Ninja ZX-10R	08-10	C8576-018	78mm	MLS/C.O.T. .018"	\$95.45					C8715	\$54.80
ZX1000 Ninja ZX-10R	11-15	C8848	77mm	MLS/C.O.T. .018"	\$83.52					C8846	\$54.80
ZX1000 Ninja ZX-10R	11-15	C8849	79mm	MLS/C.O.T. .018"	\$83.52					C8846	\$54.80
ZX1100-C1 (Ninja ZX-11)	90-93	C8740	76mm	MLS/C.O.T. .030"	\$83.52	C8358	3.290"	.010"	\$30.72		
ZX1100-C1 (Ninja ZX-11)	90-93	C8603	77mm	MLS/C.O.T. .030"	\$83.52	C8358	3.290"	.010"	\$30.72		
ZX1100-C1 (Ninja ZX-11)	90-93	C8603-018	77mm	MLS/C.O.T. .018"	\$95.45	C8358	3.290"	.010"	\$30.72		
ZX1100-C1 (Ninja ZX-11)	90-93	C8273	78mm	MLS/C.O.T. .030"	\$83.52	C8358	3.290"	.010"	\$30.72		
ZX1100-C1 (Ninja ZX-11)	90-93	C8273-018	78mm	MLS/C.O.T. .018"	\$95.45	C8358	3.290"	.010"	\$30.72		
ZX1100-C1 (Ninja ZX-11)	90-93	C8483	78mm	Copper .032"	\$65.64	C8358	3.290"	.010"	\$30.72		
ZX1100-E1 (GPZ 1100)	95-97	C8740	76mm	MLS/C.O.T. .030"	\$83.52	C8358	3.290"	.010"	\$30.72		
ZX1100-E1 (GPZ 1100)	95-97	C8603	77mm	MLS/C.O.T. .030"	\$83.52	C8358	3.290"	.010"	\$30.72		
ZX1100-E1 (GPZ 1100)	95-97	C8603-018	77mm	MLS/C.O.T. .018"	\$95.45	C8358	3.290"	.010"	\$30.72		
ZX1100-E1 (GPZ 1100)	95-97	C8273	78mm	MLS/C.O.T. .030"	\$83.52	C8358	3.290"	.010"	\$30.72		
ZX1100-E1 (GPZ 1100)	95-97	C8273-018	78mm	MLS/C.O.T. .018"	\$95.45	C8358	3.290"	.010"	\$30.72		
ZX1100-E1 (GPZ 1100)	95-97	C8483	78mm	Copper .032"	\$65.64	C8358	3.290"	.010"	\$30.72		
ZX1100-F1 (GPZ 1100 ABS)	1996	C8740	76mm	MLS/C.O.T. .030"	\$83.52	C8358	3.290"	.010"	\$30.72		
ZX1100-F1 (GPZ 1100 ABS)	1996	C8603	77mm	MLS/C.O.T. .030"	\$83.52	C8358	3.290"	.010"	\$30.72		
ZX1100-F1 (GPZ 1100 ABS)	1996	C8603-018	77mm	MLS/C.O.T. .018"	\$95.45	C8358	3.290"	.010"	\$30.72		
ZX1100-F1 (GPZ 1100 ABS)	1996	C8273	78mm	MLS/C.O.T. .030"	\$83.52	C8358	3.290"	.010"	\$30.72		
ZX1100-F1 (GPZ 1100 ABS)	1996	C8273-018	78mm	MLS/C.O.T. .018"	\$95.45	C8358	3.290"	.010"	\$30.72		
ZX1100-F1 (GPZ 1100 ABS)	1996	C8483	78mm	Copper .032"	\$65.64	C8358	3.290"	.010"	\$30.72		
ZR1100-C3 (ZRX1100) (99)	99-00	C8740	76mm	MLS/C.O.T. .030"	\$83.52	C8358	3.290"	.010"	\$30.72		
ZR1100-C3 (ZRX1100) (99)	99-00	C8603	77mm	MLS/C.O.T. .030"	\$83.52	C8358	3.290"	.010"	\$30.72		
ZR1100-C3 (ZRX1100) (99)	99-00	C8603-018	77mm	MLS/C.O.T. .018"	\$95.45	C8358	3.290"	.010"	\$30.72		
ZR1100-C3 (ZRX1100) (99)	99-00	C8273	78mm	MLS/C.O.T. .030"	\$83.52	C8358	3.290"	.010"	\$30.72		
ZR1100-C3 (ZRX1100) (99)	99-00	C8273-018	78mm	MLS/C.O.T. .018"	\$95.45	C8358	3.290"	.010"	\$30.72		
ZR1100-C3 (ZRX1100) (99)	99-00	C8483	78mm	Copper .032"	\$65.64	C8358	3.290"	.010"	\$30.72		
ZR1100	92-95	C8229	82mm	CFM-20	\$54.34	C8358	3.290"	.010"	\$30.72		
ZR1200-A (ZRX1200)	01-05	C8711	80mm	MLS/C.O.T. .027"	\$87.73	B0554020RC		.020"	\$32.36		
ZX1200-C (ZZR1200)	02-05	C8711	80mm	MLS/C.O.T. .027"	\$87.73	B0554020RC		.020"	\$32.36		
ZX-12R	00-01	C8642	83mm	MLS/C.O.T. .030"	\$87.73	C8579		.010"	\$30.72	C8497	\$42.87
ZX-12R	00-01	C8642-018	83mm	MLS/C.O.T. .018"	\$95.45	C8579		.010"	\$30.72	C8497	\$42.87
ZX-12R	00-01	C8573	84mm	MLS/C.O.T. .030"	\$87.73	C8579		.010"	\$30.72	C8497	\$42.87
ZX-12R	00-01	C8573-018	84mm	MLS/C.O.T. .018"	\$95.45	C8579		.010"	\$30.72	C8497	\$42.87
ZX-12R	00-01	C8643	85mm	MLS/C.O.T. .030"	\$87.73	C8579		.010"	\$30.72	C8497	\$42.87
ZX-12R	00-01	C8643-018	85mm	MLS/C.O.T. .018"	\$95.45	C8579		.010"	\$30.72	C8497	\$42.87
ZX-12R	00-01	C8641	86mm	MLS/C.O.T. .030"	\$87.73	C8579		.010"	\$30.72	C8497	\$42.87
ZX-12R	00-01	C8641-018	86mm	MLS/C.O.T. .018"	\$95.45	C8579		.010"	\$30.72	C8497	\$42.87
ZX-12R	02-06	C8642	83mm	MLS/C.O.T. .030"	\$87.73	C8579		.010"	\$30.72	C8497	\$42.87
ZX-12R	02-06	C8642-018	83mm	MLS/C.O.T. .018"	\$95.45	C8579		.010"	\$30.72	C8497	\$42.87
ZX-12R	02-06	C8573	84mm	MLS/C.O.T. .030"	\$87.73	C8579		.010"	\$30.72	C8497	\$42.87





# STREET-ROAD RACE-STRIP



Cometic Gasket - An Exclusive NASCAR Performance® Product

## KAWASAKI

Model	Year	Head Gasket Part#	Bore	Material/Thickness	Price	Base Gasket Part#	Bore	Material/Thickness	Price	Case Kit Part#	Price
ZX-12R	02-06	C8573-018	84mm	MLS/C.O.T. .018"	\$95.45	C8579		.010"	\$30.72	C8497	\$42.87
ZX-12R	02-06	C8643	85mm	MLS/C.O.T. .030"	\$87.73	C8579		.010"	\$30.72	C8497	\$42.87
ZX-12R	02-06	C8643-018	85mm	MLS/C.O.T. .018"	\$95.45	C8579		.010"	\$30.72	C8497	\$42.87
ZX-12R	02-06	C8641	86mm	MLS/C.O.T. .030"	\$87.73	C8579		.010"	\$30.72	C8497	\$42.87
ZX-12R	02-06	C8641-018	86mm	MLS/C.O.T. .018"	\$95.45	C8579		.010"	\$30.72	C8497	\$42.87
Ninja ZX-14	06-19	C8460-018	84mm	MLS/C.O.T. .018"	\$87.73					C8713	\$54.80
Ninja ZX-14	06-19	C8621	86mm	MLS/C.O.T. .018"	\$87.73					C8713	\$54.80
Ninja ZX-14	06-19	C8622	87mm	MLS/C.O.T. .018"	\$87.73					C8713	\$54.80

## KTM

Model	Year	Head Gasket Part#	Bore	Material/Thickness	Price	Base Gasket Part#	Bore	Material/Thickness	Price	Case Kit Part#	Price
RC390	13-17	C8897	89mm	MLS/C.O.T. .027"	\$33.23	C8899		.014" RC	\$11.87		
RC390	13-17	C8898	91mm	MLS/C.O.T. .027"	\$33.23	C8899		.014" RC	\$11.87		
390 Duke	13-19	C8897	89mm	MLS/C.O.T. .027"	\$33.23	C8899		.014" RC	\$11.87		
390 Duke	13-19	C8898	91mm	MLS/C.O.T. .027"	\$33.23	C8899		.014" RC	\$11.87		
RC8 1190	09-14	C8939	106mm	MLS/C.O.T. .030"	\$68.74						
1190 Adventure	14-17	C8939	106mm	MLS/C.O.T. .030"	\$68.74						
1290 Super Adventure	14-18	C8940	108mm	MLS/C.O.T. .032"	\$68.74						
1290 Super Duke	14-18	C8940	108mm	MLS/C.O.T. .032"	\$68.74						

## VICTORY

Model	Year	Head Gasket Part#	Bore	Material/Thickness	Price	Base Gasket Part#	Bore	Material/Thickness	Price	Case Kit Part#	Price
V92C	99-04	C8652	97mm	MLS/C.O.T. .065"	\$182.22						
V92C	99-04	C8653	101mm	MLS/C.O.T. .065"	\$182.22						

## SUZUKI

Model	Year	Head Gasket Part#	Bore	Material/Thickness	Price	Base Gasket Part#	Bore	Material/Thickness	Price	Case Kit Part#	Price
GS550E 2 Valve	77-86	C8024	60mm	CFM-20 .043"	\$51.73						
GSF600S Bandit	96-99	C8025	66.5mm	CFM-20 .043"	\$51.73						
GSF600S Bandit	00-03	C8025	66.5mm	CFM-20 .043"	\$51.73						
GSX600F Katana	98-06	C8025	66.5mm	CFM-20 .043"	\$51.73						
GSX600FT Katana	88-96	C8025	66.5mm	CFM-20 .043"	\$51.73						
GSX600FV	97	C8025	66.5mm	CFM-20 .043"	\$51.73						
GSX600F Katana	93	C8025	66.5mm	CFM-20 .043"	\$51.73						
GSX-R600	97-00	C8413	65.5mm	MLS/C.O.T. .030"	\$83.52	C8422		.010" RC	\$30.72	C8592	\$26.51
GSX-R600	01-03	C8644	68mm	MLS/C.O.T. .027"	\$87.73					C8206	\$54.82
GSX-R600	01-03	C8644-018	68mm	MLS/C.O.T. .018"	\$100.22					C8206	\$54.82
GSX-R600	01-03	C8645	69mm	MLS/C.O.T. .027"	\$87.73					C8206	\$54.82
GSX-R600	01-03	C8645-018	69mm	MLS/C.O.T. .018"	\$100.22					C8206	\$54.82
GSX-R600	01-03	C8646	70mm	MLS/C.O.T. .027"	\$87.73					C8206	\$54.82
GSX-R600	04-05	C8632	68mm	MLS/C.O.T. .030"	\$87.73					C8689	\$44.47
GSX-R600	04-05	C8632-018	68mm	MLS/C.O.T. .018"	\$100.22					C8689	\$44.47
GSX-R600	04-05	C8724	70mm	MLS/C.O.T. .030"	\$87.73					C8689	\$44.47
GSX-R600	04-05	C8724-018	70mm	MLS/C.O.T. .018"	\$100.22					C8689	\$44.47
GSX-R600	06-07										
GSX-R600	08-19	C8293	70mm	MLS/C.O.T. .027"	\$83.52					C8742	\$44.47
GSX-R600	08-19	C8293-018	70mm	MLS/C.O.T. .018"	\$95.45					C8742	\$44.47
GSX-R600	08-19	C8302	68mm	MLS/C.O.T. .027"	\$87.73					C8742	\$44.47
GSX-R600	08-19	C8302-018	68mm	MLS/C.O.T. .018"	\$100.22					C8742	\$44.47
RF600RT	94-96	C8275	67mm	MLS/C.O.T. .030"	\$83.52					C8143	\$19.87
RF600R	95	C8275	67mm	MLS/C.O.T. .030"	\$83.52					C8143	\$19.87
GSX-R600WP	92-93	C8275	67mm	MLS/C.O.T. .030"	\$83.52	C8137	3.265"	.020" Copper	\$35.38	C8143	\$19.87
DL650 V Strom	04-19	C8593	84mm	MLS/C.O.T. .030"	\$92.84	C8771		.020" RC	\$35.38		
\$7.99DL650 V Strom	04-19	C8593-018	84mm	MLS/C.O.T. .018"	\$104.77	C8615		.005" Copper	\$35.38		
DL650 V Strom	04-19	C8600	83mm	MLS/C.O.T. .030"	\$92.84	C8616		.010" Copper	\$35.38		







# STREET-ROAD RACE-STRIP



Cometic Gasket - An Exclusive NASCAR Performance® Product

Valve Cover Part#	Price	Magneto Cover Part#	Price	Clutch Cover Part#	Price	Exhaust Gasket Part#	Price	Shift Shaft Part#	Price	Output Shaft Part#	Price
EC881032AFM	\$11.36	EC882032AFM	\$15.85	EC882032AFM	\$15.85	C8745	\$27.30	OS269	\$1.48	OS397	\$4.99
EC881032AFM	\$11.36	EC882032AFM	\$15.85	EC882032AFM	\$15.85	C8745	\$27.30	OS269	\$1.48	OS397	\$4.99
EC881032AFM	\$11.36	EC882032AFM	\$15.85	EC882032AFM	\$15.85	C8745	\$27.30	OS269	\$1.48	OS397	\$4.99
EC881032AFM	\$11.36	EC882032AFM	\$15.85	EC882032AFM	\$15.85	C8745	\$27.30	OS269	\$1.48	OS397	\$4.99
EC881032AFM	\$11.36	EC882032AFM	\$15.85	EC882032AFM	\$15.85	C8745	\$27.30	OS269	\$1.48	OS397	\$4.99
EC1161032AFM	\$15.44	EC1159032AFM	\$20.22	EC1159032AFM	\$20.22	C8873	\$35.95	OS269	\$1.48	OS411	\$5.99
EC1161032AFM	\$15.44	EC1159032AFM	\$20.22	EC1159032AFM	\$20.22	C8873	\$35.95	OS269	\$1.48	OS411	\$5.99
EC1161032AFM	\$15.44	EC1159032AFM	\$20.22	EC1159032AFM	\$20.22	C8873	\$35.95	OS269	\$1.48	OS411	\$5.99

Valve Cover Part#	Price	Magneto Cover Part#	Price	Clutch Cover Part#	Price	Exhaust Gasket Part#	Price	Shift Shaft Part#	Price	Output Shaft Part#	Price
								OS331	\$3.71	OS412	\$2.79
								OS331	\$3.71	OS412	\$2.79
								OS331	\$3.71	OS412	\$2.79
								OS331	\$3.71	OS412	\$2.79

Valve Cover Part#	Price	Magneto Cover Part#	Price	Clutch Cover Part#	Price	Exhaust Gasket Part#	Price	Shift Shaft Part#	Price	Output Shaft Part#	Price

Valve Cover Part#	Price	Magneto Cover Part#	Price	Clutch Cover Part#	Price	Exhaust Gasket Part#	Price	Shift Shaft Part#	Price	Output Shaft Part#	Price
						C8884	\$35.95	OS420	\$3.99	OS413	\$10.99
EC014020F	\$6.25	EC012020F	\$6.25	EC012020F	\$6.25	C8884	\$35.95	OS420	\$3.99	OS414	\$7.99
EC014020F	\$6.25	EC012020F	\$6.25	EC012020F	\$6.25	C8884	\$35.95	OS420	\$3.99	OS414	\$7.99
EC014020F	\$6.25	EC012020F	\$6.25	EC012020F	\$6.25	C8884	\$35.95	OS420	\$3.99	OS414	\$7.99
EC014020F	\$6.25	EC012020F	\$6.25	EC012020F	\$6.25	C8884	\$35.95	OS420	\$3.99	OS414	\$7.99
EC014020F	\$6.25	EC012020F	\$6.25	EC012020F	\$6.25	C8884	\$35.95	OS420	\$3.99	OS414	\$7.99
EC014020F	\$6.25	EC012020F	\$6.25	EC012020F	\$6.25	C8884	\$35.95	OS420	\$3.99	OS414	\$7.99
EC090031F	\$4.94	EC091020F	\$8.52	EC091020F	\$8.52	C8886	\$35.95	OS305	\$5.77	OS415	\$12.99
EC519032AFM	\$10.15	EC518032AFM	\$15.90	EC518032AFM	\$15.90	C8886	\$35.95	OS305	\$5.77	OS415	\$12.99
EC519032AFM	\$10.15	EC518032AFM	\$15.90	EC518032AFM	\$15.90	C8886	\$35.95	OS305	\$5.77	OS415	\$12.99
EC519032AFM	\$10.15	EC518032AFM	\$15.90	EC518032AFM	\$15.90	C8886	\$35.95	OS305	\$5.77	OS415	\$12.99
EC519032AFM	\$10.15	EC518032AFM	\$15.90	EC518032AFM	\$15.90	C8886	\$35.95	OS305	\$5.77	OS415	\$12.99
EC946032AFM	\$8.29	EC518032AFM	\$15.90	EC518032AFM	\$15.90	C8886	\$35.95	OS305	\$5.77	OS415	\$12.99
EC946032AFM	\$8.29	EC518032AFM	\$15.90	EC518032AFM	\$15.90	C8886	\$35.95	OS305	\$5.77	OS415	\$12.99
EC946032AFM	\$8.29	EC518032AFM	\$15.90	EC518032AFM	\$15.90	C8886	\$35.95	OS305	\$5.77	OS415	\$12.99
EC1278032AFM	\$11.87	EC1276032AFM	\$14.25	EC1276032AFM	\$14.25	C8886	\$35.95	OS305	\$5.77	OS416	\$27.99
EC1278032AFM	\$11.87	EC1276032AFM	\$14.25	EC1276032AFM	\$14.25	C8886	\$35.95	OS305	\$5.77	OS416	\$27.99
EC1278032AFM	\$11.87	EC1276032AFM	\$14.25	EC1276032AFM	\$14.25	C8886	\$35.95	OS305	\$5.77	OS416	\$27.99
EC1278032AFM	\$11.87	EC1276032AFM	\$14.25	EC1276032AFM	\$14.25	C8886	\$35.95	OS305	\$5.77	OS416	\$27.99
		EC022020F	\$4.94					OS305	\$5.77	OS415	\$12.99
		EC022020F	\$4.94					OS305	\$5.77	OS415	\$12.99
		EC022020F	\$4.94					OS305	\$5.77	OS415	\$12.99
						C8746	\$13.66	OS305	5.77	OS417	\$7.99
						C8746	\$13.66	OS305	\$5.77	OS417	\$7.99
						C8746	\$13.66	OS305	\$5.77	OS417	\$7.99





# STREET-ROAD RACE-STRIP



Cometic Gasket - An Exclusive NASCAR Performance® Product

## SUZUKI

Model	Year	Head Gasket Part#	Bore	Material/Thickness	Price	Base Gasket Part#	Bore	Material/Thickness	Price	Case Kit Part#	Price
DL650 V Strom	04-19	C8593-018	84mm	MLS/C.O.T. .018"	\$104.77	C8615		.005" Copper	\$35.38		
DL650 V Strom	04-19	C8600	83mm	MLS/C.O.T. .030"	\$92.84	C8616		.010" Copper	\$35.38		
DL650 V Strom	04-19	C8600-018	83mm	MLS/C.O.T. .018"	\$104.77	C8617		.020" Copper	\$35.38		
DL650 V Strom	04-19	C8613	87mm	MLS/C.O.T. .030"	\$92.84						
DL650 V Strom	04-19	C8613-018	87mm	MLS/C.O.T. .018"	\$104.77						
DL650 V Strom	04-19	C8614	81mm	MLS/C.O.T. .030"	\$92.84						
DL650 V Strom	04-19	C8614-018	81mm	MLS/C.O.T. .018"	\$104.77						
7.99SV650	04-19	C8593	84mm	MLS/C.O.T. .030"	\$92.84	C8771		.020" RC	\$35.38		
SV650	04-19	C8593-018	84mm	MLS/C.O.T. .018"	\$104.77	C8615		.005" Copper	\$35.38		
SV650	04-19	C8600	83mm	MLS/C.O.T. .030"	\$92.84	C8616		.010" Copper	\$35.38		
SV650	04-19	C8600-018	83mm	MLS/C.O.T. .018"	\$104.77	C8617		.020" Copper	\$35.38		
SV650	04-19	C8613	87mm	MLS/C.O.T. .030"	\$92.84						
SV650	04-19	C8613-018	87mm	MLS/C.O.T. .018"	\$104.77						
SV650	04-19	C8614	81mm	MLS/C.O.T. .030"	\$92.84						
SV650	04-19	C8614-018	81mm	MLS/C.O.T. .018"	\$104.77						
GS750 2 Valve	77-79	C8028	69mm	CFM-20 .043"	\$54.34	C8528	2.900"	.020" Fiber	\$13.97		
GS750E 4 Valve	80-82	C8027	70mm	CFM-20 .043"	\$54.34	C8549	2.953"	.020" Fiber	\$13.97		
GSX-R750	86-92	C8466	71mm	MLS/C.O.T. .030"	\$83.52	B0285020F3.280"		.020" Fiber	\$13.29		
GSX-R750	86-92	C8415	74mm	MLS/C.O.T. .030"	\$83.52	B0285020F3.280"		.020" Fiber	\$13.29		
GSX-R750	86-92	C8464	77mm	MLS/C.O.T. .030"	\$83.52	B0285020F3.280"		.020" Fiber	\$13.29		
GSX-R750	86-92	C8463	79mm	MLS/C.O.T. .030"	\$87.73	B0285020F3.280"		.020" Fiber	\$13.29		
GSXR750W	93-95	C8276	71 mm	MLS/C.O.T. .030"	\$83.52	C8137	83 mm	.020" Copper	\$35.38	C8143	\$19.87
GSXR750W	93-95	C8337	75 mm	MLS/C.O.T. .030"	\$83.52	C8137	83 mm	.020" Copper	\$35.38	C8143	\$19.87
GSXR750W	93-95	C8338	77 mm	MLS/C.O.T. .030"	\$87.73	C8137	83 mm	.020" Copper	\$35.38	C8143	\$19.87
GSX-R750	96-99	C8387	72 mm	MLS/C.O.T. .030"	\$83.52	C8421		.010" RC	\$30.72	C8403	\$26.51
GSX-R750	96-99	C8387-018	72 mm	MLS/C.O.T. .018"	\$100.22	C8421		.010" RC	\$30.72	C8403	\$26.51
GSX-R750	96-99	C8414	74 mm	MLS/C.O.T. .030"	\$87.73	C8421		.010" RC	\$30.72	C8403	\$26.51
GSX-R750	96-99	C8414-018	74 mm	MLS/C.O.T. .018"	\$100.22	C8421		.010" RC	\$30.72	C8403	\$26.51
GSX-R750	96-99	C8445	75 mm	MLS/C.O.T. .030"	\$87.73	C8421		.010" RC	\$30.72	C8403	\$26.51
GSX-R750	96-99	C8445-018	75 mm	MLS/C.O.T. .018"	\$100.22	C8421		.010" RC	\$30.72	C8403	\$26.51
GSX-R750	00-05	C8663	73 mm	MLS/C.O.T. .030"	\$83.52					C8206	\$54.82
GSX-R750	00-05	C8663-018	73 mm	MLS/C.O.T. .018"	\$95.45					C8206	\$54.82
GSX-R750	00-05	C8574	74 mm	MLS/C.O.T. .030"	\$83.52					C8206	\$54.82
GSX-R750	00-05	C8574-018	74 mm	MLS/C.O.T. .018"	\$100.22					C8206	\$54.82
GSX-R750	00-05	C8214	75 mm	MLS/C.O.T. .030"	\$87.73					C8206	\$54.82
GSX-R750	00-05	C8214-018	75 mm	MLS/C.O.T. .018"	\$100.22					C8206	\$54.82
GSX-R750	00-05	C8602	76 mm	MLS/C.O.T. .030"	\$87.73					C8206	\$54.82
GSX-R750	00-05	C8602-018	76 mm	MLS/C.O.T. .018"	\$100.22					C8206	\$54.82
GSX-R750	04-19	C8717	70mm	MLS/C.O.T. .027"	\$87.73					C8742	\$44.47
GSX-R750	04-19	C8717-018	70mm	MLS/C.O.T. .018"	\$100.22					C8742	\$44.47
GSX-R750	04-19	C8718	72mm	MLS/C.O.T. .027"	\$87.73					C8742	\$44.47
GSX-R750	04-19	C8718-018	72mm	MLS/C.O.T. .018"	\$100.22					C8742	\$44.47
GSX-R750	15-18	C8717	70mm	MLS/C.O.T. .027"	\$87.73					C8742	\$44.47
GSX-R750	15-18	C8717-018	70mm	MLS/C.O.T. .018"	\$100.22					C8742	\$44.47
GSX-R750	15-18	C8718	72mm	MLS/C.O.T. .027"	\$87.73					C8742	\$44.47
GSX-R750	15-18	C8718-018	72mm	MLS/C.O.T. .018"	\$100.22					C8742	\$44.47
GSX-750F, Katana	88-97	C8415	74 mm	MLS/C.O.T. .030"	\$83.52	C8137		.020" Copper	\$35.38	C8423	\$25.21
GS850	79-83	C8028	69mm	CFM-20 .043"	\$54.34						
RF900RV	94-97	C8338	77mm	MLS/C.O.T. .027"	\$87.73	C8138	3.265"	.020" Fiber	\$13.29	C8143	\$19.87
RF900RV	94-97	C8277	78mm	MLS/C.O.T. .027"	\$87.73	C8138	3.265"	.020" Fiber	\$13.29	C8143	\$19.87
DL1000 V-Strom	02-13	C8502	99mm	MLS/C.O.T. .030"	\$87.73	C8509	4.450"	.010" RC	\$41.68		
GS1000 2 Valve	78-80	C8030	73.5mm	CFM-20 .043"	\$54.34	C8364	3.110"	.020" Copper	\$35.38		
GS1000 2 Valve	78-80	C8408	73.5mm	Copper .043"	\$65.64	C8364	3.110"	.020" Copper	\$35.38		
GS1000S 4 valve	82	C8031	75 mm	CFM-20 .043"	\$54.34	C8109	3.130"	.020" Fiber	\$13.29	C8073	\$15.90
GS1000S 4 valve	82	C8031	75 mm	CFM-20 .043"	\$54.34	C8110	3.130"	.005" Copper	\$33.68	C8073	\$15.90
GS1000S 4 valve	82	C8031	75 mm	CFM-20 .043"	\$54.34	C8111	3.130"	.010" Copper	\$33.68	C8073	\$15.90
GS1000S 4 valve	82	C8031	75 mm	CFM-20 .043"	\$54.34	C8112	3.130"	.020" Copper	\$33.68	C8073	\$15.90
GS1000S 4 valve	82	C8035	84 mm	CFM-20 .043"	\$54.34	C8177	3.460"	.005" Copper	\$33.68	C8073	\$15.90
GS1000S 4 valve	1982	C8035	84 mm	CFM-20 .043"	\$54.34	C8178	3.460"	.010" Copper	\$33.68	C8073	\$15.90
GS1000S 4 valve	1982	C8035	84 mm	CFM-20 .043"	\$54.34	C8179	3.460"	.020" Copper	\$33.68	C8073	\$15.90
GS1000S 4 valve	1982	C8035	84 mm	CFM-20 .043"	\$54.34	C8180	3.460"	.020" Fiber	\$13.29	C8073	\$15.90
GSX-R1000	01-02	C8663	73 mm	MLS/C.O.T. .030"	\$83.52					C8582	\$44.47
GSX-R1000	01-02	C8663-018	73 mm	MLS/C.O.T. .018"	\$95.45					C8582	\$44.47
GSX-R1000	01-02	C8574	74 mm	MLS/C.O.T. .030"	\$83.52					C8582	\$44.47
GSX-R1000	01-02	C8574-018	74 mm	MLS/C.O.T. .018"	\$100.22					C8582	\$44.47







# STREET-ROAD RACE-STRIP



Cometic Gasket - An Exclusive NASCAR Performance® Product

## SUZUKI

Model	Year	Head Gasket Part#	Bore	Material/Thickness	Price	Base Gasket Part#	Bore	Material/Thickness	Price	Case Kit Part#	Price
GSX-R1000	01-02	C8214	75 mm	MLS/C.O.T. .030"	\$87.73					C8582	\$44.47
GSX-R1000	01-02	C8214-018	75 mm	MLS/C.O.T. .018"	\$100.22					C8582	\$44.47
GSX-R1000	01-02	C8602	76 mm	MLS/C.O.T. .030"	\$87.73					C8582	\$44.47
GSX-R1000	01-02	C8602-018	76 mm	MLS/C.O.T. .018"	\$100.22					C8582	\$44.47
GSX-R1000	03-04	C8663	73 mm	MLS/C.O.T. .030"	\$83.52					C8689	\$44.47
GSX-R1000	03-04	C8663-018	73 mm	MLS/C.O.T. .018"	\$95.45					C8689	\$44.47
GSX-R1000	03-04	C8574	74 mm	MLS/C.O.T. .030"	\$83.52					C8689	\$44.47
GSX-R1000	03-04	C8574-018	74 mm	MLS/C.O.T. .018"	\$100.22					C8689	\$44.47
GSX-R1000	03-04	C8214	75 mm	MLS/C.O.T. .030"	\$87.73					C8689	\$44.47
GSX-R1000	03-04	C8214-018	75 mm	MLS/C.O.T. .018"	\$100.22					C8689	\$44.47
GSX-R1000	03-04	C8602	76 mm	MLS/C.O.T. .030"	\$87.73					C8689	\$44.47
GSX-R1000	03-04	C8602-018	76 mm	MLS/C.O.T. .018"	\$100.22					C8689	\$44.47
GSX-R1000	05-06	C8214	75 mm	MLS/C.O.T. .030"	\$87.73					C8689	\$44.47
GSX-R1000	05-06	C8214-018	75 mm	MLS/C.O.T. .018"	\$100.22					C8689	\$44.47
GSX-R1000	05-06	C8602	76 mm	MLS/C.O.T. .030"	\$87.73					C8689	\$44.47
GSX-R1000	05-06	C8602-018	76 mm	MLS/C.O.T. .018"	\$100.22					C8689	\$44.47
GSX-R1000	07-08	C8214	75 mm	MLS/C.O.T. .030"	\$87.73					C8752AFM	\$53.80
GSX-R1000	07-08	C8214-018	75 mm	MLS/C.O.T. .018"	\$100.22					C8752AFM	\$53.80
GSX-R1000	07-08	C8602	76 mm	MLS/C.O.T. .030"	\$87.73					C8752AFM	\$53.80
GSX-R1000	07-08	C8602-018	76 mm	MLS/C.O.T. .018"	\$100.22					C8752AFM	\$53.80
GSX-S1000	17-18	C8214	75 mm	MLS/C.O.T. .030"	\$87.73					C8752AFM	\$53.80
GSX-S1000	17-18	C8214-018	75 mm	MLS/C.O.T. .018"	\$100.22					C8752AFM	\$53.80
GSX-S1000	17-18	C8602	76 mm	MLS/C.O.T. .030"	\$87.73					C8752AFM	\$53.80
GSX-R1000	09-16	C8772	74.5 mm	MLS/C.O.T. .027"	\$83.52					C8893AFM	\$33.75
GSX-R1000	09-16	C8772-018	74.5 mm	MLS/C.O.T. .018"	\$83.52					C8893AFM	\$33.75
GSX-R1000	09-16	C8773	76 mm	MLS/C.O.T. .027"	\$83.52					C8893AFM	\$33.75
GSX-R1000	09-16	C8773-018	76 mm	MLS/C.O.T. .018"	\$83.52					C8893AFM	\$33.75
GSX-R1000	17-18	C8929	76 mm	MLS/C.O.T. .023"	\$83.52						
SV1000S	03-06	C8502	99mm	MLS/C.O.T. .030"	\$87.73	C8509	4.450"	.010" RC	\$41.68		
TL1000 R/S V-Twin	97-03	C8502	99mm	MLS/C.O.T. .030"	\$87.73	C8509	4.450"	.010" RC	\$41.68		
GS1100E 11mm Pin	80-81	C8163	72 mm	Copper .043"	\$65.64	C8109	3.130"	.020" Fiber	\$13.29	C8073	\$15.90
GS1100E 11mm Pin	80-81	C8163	72 mm	Copper .043"	\$65.64	C8110	3.130"	.005" Copper	\$33.68	C8073	\$15.90
GS1100E 11mm Pin	80-81	C8163	72 mm	Copper .043"	\$65.64	C8111	3.130"	.010" Copper	\$33.68	C8073	\$15.90
GS1100E 11mm Pin	80-81	C8163	72 mm	Copper .043"	\$65.64	C8112	3.130"	.020" Copper	\$33.68	C8073	\$15.90
GS1100E 11mm Pin	80-81	C8185	75 mm	Copper .043"	\$65.64	C8109	3.130"	.020" Fiber	\$13.29	C8073	\$15.90
GS1100E 11mm Pin	80-81	C8185	75 mm	Copper .043"	\$65.64	C8110	3.130"	.005" Copper	\$33.68	C8073	\$15.90
GS1100E 11mm Pin	80-81	C8185	75 mm	Copper .043"	\$65.64	C8111	3.130"	.010" Copper	\$33.68	C8073	\$15.90
GS1100E 11mm Pin	80-81	C8185	75 mm	Copper .043"	\$65.64	C8112	3.130"	.020" Copper	\$33.68	C8073	\$15.90
GS1100E 11mm Pin	80-81	C8728-045	75mm	MLS/C.O.T. .045"	\$87.73	C8109	3.130"	.020" Fiber	\$13.29	C8073	\$15.90
GS1100E 11mm Pin	80-81	C8728-045	75mm	MLS/C.O.T. .045"	\$87.73	C8110	3.130"	.005" Copper	\$33.68	C8073	\$15.90
GS1100E 11mm Pin	80-81	C8728-045	75mm	MLS/C.O.T. .045"	\$87.73	C8111	3.130"	.010" Copper	\$33.68	C8073	\$15.90
GS1100E 11mm Pin	80-81	C8728-045	75mm	MLS/C.O.T. .045"	\$87.73	C8112	3.130"	.020" Copper	\$33.68	C8073	\$15.90
GS1100E 11mm Pin	80-81	C8165	76 mm	Copper .043"	\$65.64	C8113	3.290"	.020" Fiber	\$13.29	C8073	\$15.90
GS1100E 11mm Pin	80-81	C8165	76 mm	Copper .043"	\$65.64	C8114	3.290"	.005" Copper	\$33.68	C8073	\$15.90
GS1100E 11mm Pin	80-81	C8165	76 mm	Copper .043"	\$65.64	C8115	3.290"	.010" Copper	\$33.68	C8073	\$15.90
GS1100E 11mm Pin	80-81	C8165	76 mm	Copper .043"	\$65.64	C8116	3.290"	.020" Copper	\$33.68	C8073	\$15.90
GS1100E 11mm Pin	80-81	C8729-045	76 mm	MLS/C.O.T. .045"	\$87.73	C8113	3.290"	.020" Fiber	\$13.29	C8073	\$15.90
GS1100E 11mm Pin	80-81	C8729-045	76 mm	MLS/C.O.T. .045"	\$87.73	C8114	3.290"	.005" Copper	\$33.68	C8073	\$15.90
GS1100E 11mm Pin	80-81	C8729-045	76 mm	MLS/C.O.T. .045"	\$87.73	C8115	3.290"	.010" Copper	\$33.68	C8073	\$15.90
GS1100E 11mm Pin	80-81	C8729-045	76 mm	MLS/C.O.T. .045"	\$87.73	C8116	3.290"	.020" Copper	\$33.68	C8073	\$15.90
GS1100E 11mm Pin	80-81	C8186	77 mm	Copper .043"	\$65.64	C8113	3.290"	.020" Fiber	\$13.29	C8073	\$15.90
GS1100E 11mm Pin	80-81	C8186	77 mm	Copper .043"	\$65.64	C8114	3.290"	.005" Copper	\$33.68	C8073	\$15.90
GS1100E 11mm Pin	80-81	C8186	77 mm	Copper .043"	\$65.64	C8115	3.290"	.010" Copper	\$33.68	C8073	\$15.90
GS1100E 11mm Pin	80-81	C8186	77 mm	Copper .043"	\$65.64	C8116	3.290"	.020" Copper	\$33.68	C8073	\$15.90
GS1100E 11mm Pin	80-81	C8166	78 mm	Copper .043"	\$65.64	C8113	3.290"	.020" Fiber	\$13.29	C8073	\$15.90
GS1100E 11mm Pin	80-81	C8166	78 mm	Copper .043"	\$65.64	C8114	3.290"	.005" Copper	\$33.68	C8073	\$15.90
GS1100E 11mm Pin	80-81	C8166	78 mm	Copper .043"	\$65.64	C8115	3.290"	.010" Copper	\$33.68	C8073	\$15.90
GS1100E 11mm Pin	80-81	C8166	78 mm	Copper .043"	\$65.64	C8116	3.290"	.020" Copper	\$33.68	C8073	\$15.90
GS1100E 11mm Pin	80-81	C8167	79 mm	Copper .043"	\$65.64	C8113	3.290"	.020" Fiber	\$13.29	C8073	\$15.90
GS1100E 11mm Pin	80-81	C8167	79 mm	Copper .043"	\$65.64	C8114	3.290"	.005" Copper	\$33.68	C8073	\$15.90
GS1100E 11mm Pin	80-81	C8167	79 mm	Copper .043"	\$65.64	C8115	3.290"	.010" Copper	\$33.68	C8073	\$15.90
GS1100E 11mm Pin	80-81	C8167	79 mm	Copper .043"	\$65.64	C8116	3.290"	.020" Copper	\$33.68	C8073	\$15.90
GS1100E 11mm Pin	80-81	C8730-045	79 mm	MLS/C.O.T. .045"	\$87.73	C8113	3.290"	.020" Fiber	\$13.29	C8073	\$15.90
GS1100E 11mm Pin	80-81	C8730-045	79 mm	MLS/C.O.T. .045"	\$87.73	C8114	3.290"	.005" Copper	\$33.68	C8073	\$15.90
GS1100E 11mm Pin	80-81	C8730-045	79 mm	MLS/C.O.T. .045"	\$87.73	C8115	3.290"	.010" Copper	\$33.68	C8073	\$15.90









# STREET-ROAD RACE-STRIP



Cometic Gasket - An Exclusive NASCAR Performance® Product

## SUZUKI

Model	Year	Head Gasket Part#	Bore	Material/Thickness	Price	Base Gasket Part#	Bore	Material/Thickness	Price	Case Kit Part#	Price
GS1100E 11mm Pin	80-81	C8730-045	79 mm	MLS/C.O.T. .045"	\$87.73	C8116	3.290"	.020" Copper	\$33.68	C8073	\$15.90
GS1100E 11mm Pin	80-81	C8168	80 mm	Copper .043"	\$65.64	C8177	3.460"	.005" Copper	\$33.68	C8073	\$15.90
GS1100E 11mm Pin	80-81	C8168	80 mm	Copper .043"	\$65.64	C8178	3.460"	.010" Copper	\$33.68	C8073	\$15.90
GS1100E 11mm Pin	80-81	C8168	80 mm	Copper .043"	\$65.64	C8179	3.460"	.020" Copper	\$33.68	C8073	\$15.90
GS1100E 11mm Pin	80-81	C8168	80 mm	Copper .043"	\$65.64	C8180	3.460"	.020" Fiber	\$13.29	C8073	\$15.90
GS1100E 11mm Pin	80-81	C8731-045	80 mm	MLS/C.O.T. .045"	\$87.73	C8177	3.460"	.005" Copper	\$33.68	C8073	\$15.90
GS1100E 11mm Pin	80-81	C8731-045	80 mm	MLS/C.O.T. .045"	\$87.73	C8178	3.460"	.010" Copper	\$33.68	C8073	\$15.90
GS1100E 11mm Pin	80-81	C8731-045	80 mm	MLS/C.O.T. .045"	\$87.73	C8179	3.460"	.020" Copper	\$33.68	C8073	\$15.90
GS1100E 11mm Pin	80-81	C8731-045	80 mm	MLS/C.O.T. .045"	\$87.73	C8180	3.460"	.020" Fiber	\$13.29	C8073	\$15.90
GS1100E D Pin	80-81	C8470	82 mm	Copper .043"	\$65.64	C8177	3.460"	.005" Copper	\$33.68	C8073	\$15.90
GS1100E D Pin	80-81	C8470	82 mm	Copper .043"	\$65.64	C8178	3.460"	.010" Copper	\$33.68	C8073	\$15.90
GS1100E D Pin	80-81	C8470	82 mm	Copper .043"	\$65.64	C8179	3.460"	.020" Copper	\$33.68	C8073	\$15.90
GS1100E D Pin	80-81	C8470	82 mm	Copper .043"	\$65.64	C8180	3.460"	.020" Fiber	\$13.29	C8073	\$15.90
GS1100E 11mm Pin	80-81	C8169	82 mm	Copper .043"	\$65.64	C8177	3.460"	.005" Copper	\$33.68	C8073	\$15.90
GS1100E 11mm Pin	80-81	C8169	82 mm	Copper .043"	\$65.64	C8178	3.460"	.010" Copper	\$33.68	C8073	\$15.90
GS1100E 11mm Pin	80-81	C8169	82 mm	Copper .043"	\$65.64	C8179	3.460"	.020" Copper	\$33.68	C8073	\$15.90
GS1100E 11mm Pin	80-81	C8169	82 mm	Copper .043"	\$65.64	C8180	3.460"	.020" Fiber	\$13.29	C8073	\$15.90
GS1100E D Pin	80-81	C8471	83 mm	Copper .043"	\$65.64	C8117	3.560"	.020" Fiber	\$13.29	C8073	\$15.90
GS1100E D Pin	80-81	C8471	83 mm	Copper .043"	\$65.64	C8118	3.560"	.005" Copper	\$33.68	C8073	\$15.90
GS1100E D Pin	80-81	C8471	83 mm	Copper .043"	\$65.64	C8119	3.560"	.010" Copper	\$33.68	C8073	\$15.90
GS1100E D Pin	80-81	C8471	83 mm	Copper .043"	\$65.64	C8120	3.560"	.020" Copper	\$33.68	C8073	\$15.90
GS1100E 11mm Pin	80-81	C8170	83 mm	Copper .043"	\$65.64	C8117	3.560"	.020" Fiber	\$13.29	C8073	\$15.90
GS1100E 11mm Pin	80-81	C8170	83 mm	Copper .043"	\$65.64	C8118	3.560"	.005" Copper	\$33.68	C8073	\$15.90
GS1100E 11mm Pin	80-81	C8170	83 mm	Copper .043"	\$65.64	C8119	3.560"	.010" Copper	\$33.68	C8073	\$15.90
GS1100E 11mm Pin	80-81	C8170	83 mm	Copper .043"	\$65.64	C8120	3.560"	.020" Copper	\$33.68	C8073	\$15.90
GS1100E D Pin	80-81	C8732-045	83 mm	MLS/C.O.T. .045"	\$87.73	C8117	3.560"	.020" Fiber	\$13.29	C8073	\$15.90
GS1100E D Pin	80-81	C8732-045	83 mm	MLS/C.O.T. .045"	\$87.73	C8118	3.560"	.005" Copper	\$33.68	C8073	\$15.90
GS1100E D Pin	80-81	C8732-045	83 mm	MLS/C.O.T. .045"	\$87.73	C8119	3.560"	.010" Copper	\$33.68	C8073	\$15.90
GS1100E D Pin	80-81	C8732-045	83 mm	MLS/C.O.T. .045"	\$87.73	C8120	3.560"	.020" Copper	\$33.68	C8073	\$15.90
GS1100E 11mm Pin	80-81	C8035	84 mm	Fiber .043"	\$54.34	C8117	3.560"	.020" Fiber	\$13.29	C8073	\$15.90
GS1100E 11mm Pin	80-81	C8035	84 mm	Fiber .043"	\$54.34	C8118	3.560"	.005" Copper	\$33.68	C8073	\$15.90
GS1100E 11mm Pin	80-81	C8035	84 mm	Fiber .043"	\$54.34	C8119	3.560"	.010" Copper	\$33.68	C8073	\$15.90
GS1100E 11mm Pin	80-81	C8035	84 mm	Fiber .043"	\$54.34	C8120	3.560"	.020" Copper	\$33.68	C8073	\$15.90
GS1100E 6mm Pin	80-81	C8187	85 mm	Copper .043"	\$65.64	C8117	3.560"	.020" Fiber	\$13.29	C8073	\$15.90
GS1100E 6mm Pin	80-81	C8187	85 mm	Copper .043"	\$65.64	C8118	3.560"	.005" Copper	\$33.68	C8073	\$15.90
GS1100E 6mm Pin	80-81	C8187	85 mm	Copper .043"	\$65.64	C8119	3.560"	.010" Copper	\$33.68	C8073	\$15.90
GS1100E 6mm Pin	80-81	C8187	85 mm	Copper .043"	\$65.64	C8120	3.560"	.020" Copper	\$33.68	C8073	\$15.90
GS1100E 8mm Pin	80-81	C8439	85 mm	Copper .043"	\$65.64	C8117	3.560"	.020" Fiber	\$13.29	C8073	\$15.90
GS1100E 8mm Pin	80-81	C8439	85 mm	Copper .043"	\$65.64	C8118	3.560"	.005" Copper	\$33.68	C8073	\$15.90
GS1100E 8mm Pin	80-81	C8439	85 mm	Copper .043"	\$65.64	C8119	3.560"	.010" Copper	\$33.68	C8073	\$15.90
GS1100E 8mm Pin	80-81	C8439	85 mm	Copper .043"	\$65.64	C8120	3.560"	.020" Copper	\$33.68	C8073	\$15.90
GS1100E D Pin	80-81	C8473	85 mm	Copper .043"	\$65.64	C8117	3.560"	.020" Fiber	\$13.29	C8073	\$15.90
GS1100E D Pin	80-81	C8473	85 mm	Copper .043"	\$65.64	C8118	3.560"	.005" Copper	\$33.68	C8073	\$15.90
GS1100E D Pin	80-81	C8473	85 mm	Copper .043"	\$65.64	C8119	3.560"	.010" Copper	\$33.68	C8073	\$15.90
GS1100E D Pin	80-81	C8473	85 mm	Copper .043"	\$65.64	C8120	3.560"	.020" Copper	\$33.68	C8073	\$15.90
GS1100E D Pin	80-81	C8733-045	85 mm	MLS/C.O.T. .045"	\$87.73	C8117	3.560"	.020" Fiber	\$13.29	C8073	\$15.90
GS1100E D Pin	80-81	C8733-045	85 mm	MLS/C.O.T. .045"	\$87.73	C8118	3.560"	.005" Copper	\$33.68	C8073	\$15.90
GS1100E D Pin	80-81	C8733-045	85 mm	MLS/C.O.T. .045"	\$87.73	C8119	3.560"	.010" Copper	\$33.68	C8073	\$15.90
GS1100E D Pin	80-81	C8733-045	85 mm	MLS/C.O.T. .045"	\$87.73	C8120	3.560"	.020" Copper	\$33.68	C8073	\$15.90
GS1100E 6mm Pin	80-81	C8171	87 mm	Copper .043"	\$65.64	C8117	3.560"	.020" Fiber	\$13.29	C8073	\$15.90
GS1100E 6mm Pin	80-81	C8171	87 mm	Copper .043"	\$65.64	C8118	3.560"	.005" Copper	\$33.68	C8073	\$15.90
GS1100E 6mm Pin	80-81	C8171	87 mm	Copper .043"	\$65.64	C8119	3.560"	.010" Copper	\$33.68	C8073	\$15.90
GS1100E 6mm Pin	80-81	C8171	87 mm	Copper .043"	\$65.64	C8120	3.560"	.020" Copper	\$33.68	C8073	\$15.90
GS1100E 6mm Pin	80-81	C8734-045	87 mm	MLS/C.O.T. .045"	\$87.73	C8117	3.560"	.020" Fiber	\$13.29	C8073	\$15.90
GS1100E 6mm Pin	80-81	C8734-045	87 mm	MLS/C.O.T. .045"	\$87.73	C8118	3.560"	.005" Copper	\$33.68	C8073	\$15.90
GS1100E 6mm Pin	80-81	C8734-045	87 mm	MLS/C.O.T. .045"	\$87.73	C8119	3.560"	.010" Copper	\$33.68	C8073	\$15.90
GS1100E 6mm Pin	80-81	C8734-045	87 mm	MLS/C.O.T. .045"	\$87.73	C8120	3.560"	.020" Copper	\$33.68	C8073	\$15.90
GS1100E	80-81	C8735-045	89 mm	MLS/C.O.T. .045"	\$87.73	C8375	3.660"	.005" Copper	\$33.68	C8073	\$15.90
GS1100E	80-81	C8735-045	89 mm	MLS/C.O.T. .045"	\$87.73	C8376	3.660"	.010" Copper	\$33.68	C8073	\$15.90
GS1100E	80-81	C8735-045	89 mm	MLS/C.O.T. .045"	\$87.73	C8377	3.660"	.020" Copper	\$33.68	C8073	\$15.90
GS1100E 11mm Pin	82-83	C8163	72 mm	Copper .043"	\$65.64	C8109	3.130"	.020" Fiber	\$13.29	C8073	\$15.90
GS1100E 11mm Pin	82-83	C8163	72 mm	Copper .043"	\$65.64	C8110	3.130"	.005" Copper	\$33.68	C8073	\$15.90
GS1100E 11mm Pin	82-83	C8163	72 mm	Copper .043"	\$65.64	C8111	3.130"	.010" Copper	\$33.68	C8073	\$15.90
GS1100E 11mm Pin	82-83	C8163	72 mm	Copper .043"	\$65.64	C8112	3.130"	.020" Copper	\$33.68	C8073	\$15.90
GS1100E 11mm Pin	82-83	C8185	75 mm	Copper .043"	\$65.64	C8109	3.130"	.020" Fiber	\$13.29	C8073	\$15.90









# STREET-ROAD RACE-STRIP



Cometic Gasket - An Exclusive NASCAR Performance® Product

## SUZUKI

Model	Year	Head Gasket Part#	Boze	Material/Thickness	Price	Base Gasket Part#	Boze	Material/Thickness	Price	Case Kit Part#	Price
GS1100E 11mm Pin	82-83	C8185	75 mm	Copper .043"	\$65.64	C8110	3.130"	.005" Copper	\$33.68	C8073	\$15.90
GS1100E 11mm Pin	82-83	C8185	75 mm	Copper .043"	\$65.64	C8111	3.130"	.010" Copper	\$33.68	C8073	\$15.90
GS1100E 11mm Pin	82-83	C8185	75 mm	Copper .043"	\$65.64	C8112	3.130"	.020" Copper	\$33.68	C8073	\$15.90
GS1100E 11mm Pin	82-83	C8728-045	75mm	MLS/C.O.T. .045"	\$87.73	C8109	3.130"	.020" Fiber	\$13.29	C8073	\$15.90
GS1100E 11mm Pin	82-83	C8728-045	75mm	MLS/C.O.T. .045"	\$87.73	C8110	3.130"	.005" Copper	\$33.68	C8073	\$15.90
GS1100E 11mm Pin	82-83	C8728-045	75mm	MLS/C.O.T. .045"	\$87.73	C8111	3.130"	.010" Copper	\$33.68	C8073	\$15.90
GS1100E 11mm Pin	82-83	C8728-045	75mm	MLS/C.O.T. .045"	\$87.73	C8112	3.130"	.020" Copper	\$33.68	C8073	\$15.90
GS1100E 11mm Pin	82-83	C8165	76 mm	Copper .043"	\$65.64	C8113	3.290"	.020" Fiber	\$13.29	C8073	\$15.90
GS1100E 11mm Pin	82-83	C8165	76 mm	Copper .043"	\$65.64	C8114	3.290"	.005" Copper	\$33.68	C8073	\$15.90
GS1100E 11mm Pin	82-83	C8165	76 mm	Copper .043"	\$65.64	C8115	3.290"	.010" Copper	\$33.68	C8073	\$15.90
GS1100E 11mm Pin	82-83	C8165	76 mm	Copper .043"	\$65.64	C8116	3.290"	.020" Copper	\$33.68	C8073	\$15.90
GS1100E 11mm Pin	82-83	C8729-045	76 mm	MLS/C.O.T. .045"	\$87.73	C8113	3.290"	.020" Fiber	\$13.29	C8073	\$15.90
GS1100E 11mm Pin	82-83	C8729-045	76 mm	MLS/C.O.T. .045"	\$87.73	C8114	3.290"	.005" Copper	\$33.68	C8073	\$15.90
GS1100E 11mm Pin	82-83	C8729-045	76 mm	MLS/C.O.T. .045"	\$87.73	C8115	3.290"	.010" Copper	\$33.68	C8073	\$15.90
GS1100E 11mm Pin	82-83	C8729-045	76 mm	MLS/C.O.T. .045"	\$87.73	C8116	3.290"	.020" Copper	\$33.68	C8073	\$15.90
GS1100E 11mm Pin	82-83	C8186	77 mm	Copper .043"	\$65.64	C8113	3.290"	.020" Fiber	\$13.29	C8073	\$15.90
GS1100E 11mm Pin	82-83	C8186	77 mm	Copper .043"	\$65.64	C8114	3.290"	.005" Copper	\$33.68	C8073	\$15.90
GS1100E 11mm Pin	82-83	C8186	77 mm	Copper .043"	\$65.64	C8115	3.290"	.010" Copper	\$33.68	C8073	\$15.90
GS1100E 11mm Pin	82-83	C8186	77 mm 1	Copper .043"	\$65.64	C8116	3.290"	.020" Copper	\$33.68	C8073	\$15.90
GS1100E 11mm Pin	82-83	C8166	78 mm	Copper .043"	\$65.64	C8113	3.290"	.020" Fiber	\$13.29	C8073	\$15.90
GS1100E 11mm Pin	82-83	C8166	78 mm	Copper .043"	\$65.64	C8114	3.290"	.005" Copper	\$33.68	C8073	\$15.90
GS1100E 11mm Pin	82-83	C8166	78 mm	Copper .043"	\$65.64	C8115	3.290"	.010" Copper	\$33.68	C8073	\$15.90
GS1100E 11mm Pin	82-83	C8166	78 mm	Copper .043"	\$65.64	C8116	3.290"	.020" Copper	\$33.68	C8073	\$15.90
GS1100E 11mm Pin	82-83	C8167	79 mm	Copper .043"	\$65.64	C8113	3.290"	.020" Fiber	\$13.29	C8073	\$15.90
GS1100E 11mm Pin	82-83	C8167	79 mm	Copper .043"	\$65.64	C8114	3.290"	.005" Copper	\$33.68	C8073	\$15.90
GS1100E 11mm Pin	82-83	C8167	79 mm	Copper .043"	\$65.64	C8115	3.290"	.010" Copper	\$33.68	C8073	\$15.90
GS1100E 11mm Pin	82-83	C8167	79 mm	Copper .043"	\$65.64	C8116	3.290"	.020" Copper	\$33.68	C8073	\$15.90
GS1100E 11mm Pin	82-83	C8730-045	79 mm	MLS/C.O.T. .045"	\$87.73	C8113	3.290"	.020" Fiber	\$13.29	C8073	\$15.90
GS1100E 11mm Pin	82-83	C8730-045	79 mm	MLS/C.O.T. .045"	\$87.73	C8114	3.290"	.005" Copper	\$33.68	C8073	\$15.90
GS1100E 11mm Pin	82-83	C8730-045	79 mm	MLS/C.O.T. .045"	\$87.73	C8115	3.290"	.010" Copper	\$33.68	C8073	\$15.90
GS1100E 11mm Pin	82-83	C8730-045	79 mm	MLS/C.O.T. .045"	\$87.73	C8116	3.290"	.020" Copper	\$33.68	C8073	\$15.90
GS1100E 11mm Pin	82-83	C8168	80 mm	Copper .043"	\$65.64	C8177	3.460"	.005" Copper	\$33.68	C8073	\$15.90
GS1100E 11mm Pin	82-83	C8168	80 mm	Copper .043"	\$65.64	C8178	3.460"	.010" Copper	\$33.68	C8073	\$15.90
GS1100E 11mm Pin	82-83	C8168	80 mm	Copper .043"	\$65.64	C8179	3.460"	.020" Copper	\$33.68	C8073	\$15.90
GS1100E 11mm Pin	82-83	C8168	80 mm	Copper .043"	\$65.64	C8180	3.460"	.020" Fiber	\$13.29	C8073	\$15.90
GS1100E 11mm Pin	82-83	C8731-045	80 mm	MLS/C.O.T. .045"	\$87.73	C8177	3.460"	.005" Copper	\$33.68	C8073	\$15.90
GS1100E 11mm Pin	82-83	C8731-045	80 mm	MLS/C.O.T. .045"	\$87.73	C8178	3.460"	.010" Copper	\$33.68	C8073	\$15.90
GS1100E 11mm Pin	82-83	C8731-045	80 mm	MLS/C.O.T. .045"	\$87.73	C8179	3.460"	.020" Copper	\$33.68	C8073	\$15.90
GS1100E 11mm Pin	82-83	C8731-045	80 mm	MLS/C.O.T. .045"	\$87.73	C8180	3.460"	.020" Fiber	\$13.29	C8073	\$15.90
GS1100E D Pin	82-83	C8470	82 mm	Copper .043"	\$65.64	C8177	3.460"	.005" Copper	\$33.68	C8073	\$15.90
GS1100E D Pin	82-83	C8470	82 mm	Copper .043"	\$65.64	C8178	3.460"	.010" Copper	\$33.68	C8073	\$15.90
GS1100E D Pin	82-83	C8470	82 mm	Copper .043"	\$65.64	C8179	3.460"	.020" Copper	\$33.68	C8073	\$15.90
GS1100E D Pin	82-83	C8470	82 mm	Copper .043"	\$65.64	C8180	3.460"	.020" Fiber	\$13.29	C8073	\$15.90
GS1100E 11mm Pin	82-83	C8169	82 mm	Copper .043"	\$65.64	C8177	3.460"	.005" Copper	\$33.68	C8073	\$15.90
GS1100E 11mm Pin	82-83	C8169	82 mm	Copper .043"	\$65.64	C8178	3.460"	.010" Copper	\$33.68	C8073	\$15.90
GS1100E 11mm Pin	82-83	C8169	82 mm	Copper .043"	\$65.64	C8179	3.460"	.020" Copper	\$33.68	C8073	\$15.90
GS1100E 11mm Pin	82-83	C8169	82 mm	Copper .043"	\$65.64	C8180	3.460"	.020" Fiber	\$13.29	C8073	\$15.90
GS1100E D Pin	82-83	C8471	83 mm	Copper .043"	\$65.64	C8117	3.560"	.020" Fiber	\$13.29	C8073	\$15.90
GS1100E D Pin	82-83	C8471	83 mm	Copper .043"	\$65.64	C8118	3.560"	.005" Copper	\$33.68	C8073	\$15.90
GS1100E D Pin	82-83	C8471	83 mm	Copper .043"	\$65.64	C8119	3.560"	.010" Copper	\$33.68	C8073	\$15.90
GS1100E D Pin	82-83	C8471	83 mm	Copper .043"	\$65.64	C8120	3.560"	.020" Copper	\$33.68	C8073	\$15.90
GS1100E 11mm Pin	82-83	C8170	83 mm	Copper .043"	\$65.64	C8117	3.560"	.020" Fiber	\$13.29	C8073	\$15.90
GS1100E 11mm Pin	82-83	C8170	83 mm	Copper .043"	\$65.64	C8118	3.560"	.005" Copper	\$33.68	C8073	\$15.90
GS1100E 11mm Pin	82-83	C8170	83 mm	Copper .043"	\$65.64	C8119	3.560"	.010" Copper	\$33.68	C8073	\$15.90
GS1100E 11mm Pin	82-83	C8170	83 mm	Copper .043"	\$65.64	C8120	3.560"	.020" Copper	\$33.68	C8073	\$15.90
GS1100E D Pin	82-83	C8732-045	83 mm	MLS/C.O.T. .045"	\$87.73	C8117	3.560"	.020" Fiber	\$13.29	C8073	\$15.90
GS1100E D Pin	82-83	C8732-045	83 mm	MLS/C.O.T. .045"	\$87.73	C8118	3.560"	.005" Copper	\$33.68	C8073	\$15.90
GS1100E D Pin	82-83	C8732-045	83 mm	MLS/C.O.T. .045"	\$87.73	C8119	3.560"	.010" Copper	\$33.68	C8073	\$15.90
GS1100E D Pin	82-83	C8732-045	83 mm	MLS/C.O.T. .045"	\$87.73	C8120	3.560"	.020" Copper	\$33.68	C8073	\$15.90
GS1100E 11mm Pin	82-83	C8035	84 mm	Fiber .043"	\$54.34	C8117	3.560"	.020" Fiber	\$13.29	C8073	\$15.90
GS1100E 11mm Pin	82-83	C8035	84 mm	Fiber .043"	\$54.34	C8118	3.560"	.005" Copper	\$33.68	C8073	\$15.90
GS1100E 11mm Pin	82-83	C8035	84 mm	Fiber .043"	\$54.34	C8119	3.560"	.010" Copper	\$33.68	C8073	\$15.90
GS1100E 11mm Pin	82-83	C8035	84 mm	Fiber .043"	\$54.34	C8120	3.560"	.020" Copper	\$33.68	C8073	\$15.90
GS1100E 6mm Pin	82-83	C8187	85 mm	Copper .043"	\$65.64	C8117	3.560"	.020" Fiber	\$13.29	C8073	\$15.90
GS1100E 6mm Pin	82-83	C8187	85 mm	Copper .043"	\$65.64	C8118	3.560"	.005" Copper	\$33.68	C8073	\$15.90







# STREET-ROAD RACE-STRIP



Cometic Gasket - An Exclusive NASCAR Performance® Product

## SUZUKI

Model	Year	Head Gasket Part#	Bore	Material/Thickness	Price	Bass Gasket Part#	Bore	Material/Thickness	Price	Case Ktt Part#	Price
GS1100E 6mm Pin	82-83	C8187	85 mm	Copper .043"	\$65.64	C8119	3.560"	.010" Copper	\$33.68	C8073	\$15.90
GS1100E 6mm Pin	82-83	C8187	85 mm	Copper .043"	\$65.64	C8120	3.560"	.020" Copper	\$33.68	C8073	\$15.90
GS1100E 8mm Pin	82-83	C8439	85 mm	Copper .043"	\$65.64	C8117	3.560"	.020" Fiber	\$13.29	C8073	\$15.90
GS1100E 8mm Pin	82-83	C8439	85 mm	Copper .043"	\$65.64	C8118	3.560"	.005" Copper	\$33.68	C8073	\$15.90
GS1100E 8mm Pin	82-83	C8439	85 mm	Copper .043"	\$65.64	C8119	3.560"	.010" Copper	\$33.68	C8073	\$15.90
GS1100E 8mm Pin	82-83	C8439	85 mm	Copper .043"	\$65.64	C8120	3.560"	.020" Copper	\$33.68	C8073	\$15.90
GS1100E D Pin	82-83	C8473	85 mm	Copper .043"	\$65.64	C8117	3.560"	.020" Fiber	\$13.29	C8073	\$15.90
GS1100E D Pin	82-83	C8473	85 mm	Copper .043"	\$65.64	C8118	3.560"	.005" Copper	\$33.68	C8073	\$15.90
GS1100E D Pin	82-83	C8473	85 mm	Copper .043"	\$65.64	C8119	3.560"	.010" Copper	\$33.68	C8073	\$15.90
GS1100E D Pin	82-83	C8473	85 mm	Copper .043"	\$65.64	C8120	3.560"	.020" Copper	\$33.68	C8073	\$15.90
GS1100E D Pin	82-83	C8733-045	85 mm	MLS/C.O.T. .045"	\$87.73	C8117	3.560"	.020" Fiber	\$13.29	C8073	\$15.90
GS1100E D Pin	82-83	C8733-045	85 mm	MLS/C.O.T. .045"	\$87.73	C8118	3.560"	.005" Copper	\$33.68	C8073	\$15.90
GS1100E D Pin	82-83	C8733-045	85 mm	MLS/C.O.T. .045"	\$87.73	C8119	3.560"	.010" Copper	\$33.68	C8073	\$15.90
GS1100E D Pin	82-83	C8733-045	85 mm	MLS/C.O.T. .045"	\$87.73	C8120	3.560"	.020" Copper	\$33.68	C8073	\$15.90
GS1100E 6mm Pin	82-83	C8171	87 mm	Copper .043"	\$65.64	C8117	3.560"	.020" Fiber	\$13.29	C8073	\$15.90
GS1100E 6mm Pin	82-83	C8171	87 mm	Copper .043"	\$65.64	C8118	3.560"	.005" Copper	\$33.68	C8073	\$15.90
GS1100E 6mm Pin	82-83	C8171	87 mm	Copper .043"	\$65.64	C8119	3.560"	.010" Copper	\$33.68	C8073	\$15.90
GS1100E 6mm Pin	82-83	C8171	87 mm	Copper .043"	\$65.64	C8120	3.560"	.020" Copper	\$33.68	C8073	\$15.90
GS1100E 6mm Pin	82-83	C8734-045	87 mm	MLS/C.O.T. .045"	\$87.73	C8117	3.560"	.020" Fiber	\$13.29	C8073	\$15.90
GS1100E 6mm Pin	82-83	C8734-045	87 mm	MLS/C.O.T. .045"	\$87.73	C8118	3.560"	.005" Copper	\$33.68	C8073	\$15.90
GS1100E 6mm Pin	82-83	C8734-045	87 mm	MLS/C.O.T. .045"	\$87.73	C8119	3.560"	.010" Copper	\$33.68	C8073	\$15.90
GS1100E 6mm Pin	82-83	C8734-045	87 mm	MLS/C.O.T. .045"	\$87.73	C8120	3.560"	.020" Copper	\$33.68	C8073	\$15.90
GS1100E No Pins	82-83	C8735-045	89 mm	MLS/C.O.T. .045"	\$87.73	C8375	3.660"	Copper	\$33.68	C8073	\$15.90
GS1100E No Pins	82-83	C8735-045	89 mm	MLS/C.O.T. .045"	\$87.73	C8376	3.660"	.010" Copper	\$33.68	C8073	\$15.90
GS1100E No Pins	82-83	C8735-045	89 mm	MLS/C.O.T. .045"	\$87.73	C8377	3.660"	.020" Copper	\$33.68	C8073	\$15.90
GSX-R1100	89-92	C8189	78mm	Copper .032"	\$65.64	C8297	3.370"	.005" Copper	\$35.38	C8081AFM	\$30.49
GSX-R1100	89-92	C8189	78mm	Copper .032"	\$65.64	C8069	3.370"	.010" Copper	\$35.38	C8081AFM	\$30.49
GSX-R1100	89-92	C8189	78mm	Copper .032"	\$65.64	C8462	3.370"	.020" Copper	\$35.38	C8081AFM	\$30.49
GSX-R1100	89-92	C8189	78mm	Copper .032"	\$65.64	C8298	3.370"	.020" Fiber	\$13.97	C8081AFM	\$30.49
GSX-R1100	89-92	C8189	78mm	Copper .032"	\$65.64	C8372	3.370"	.010" RC	\$30.72	C8081AFM	\$30.49
GSX-R1100	89-92	C8322	78mm	MLS/C.O.T. .030"	\$87.73	C8297	3.370"	.005" Copper	\$35.38	C8081AFM	\$30.49
GSX-R1100	89-92	C8322	78mm	MLS/C.O.T. .030"	\$87.73	C8069	3.370"	.010" Copper	\$35.38	C8081AFM	\$30.49
GSX-R1100	89-92	C8322	78mm	MLS/C.O.T. .030"	\$87.73	C8462	3.370"	.020" Copper	\$35.38	C8081AFM	\$30.49
GSX-R1100	89-92	C8322	78mm	MLS/C.O.T. .030"	\$87.73	C8298	3.370"	.020" Fiber	\$13.97	C8081AFM	\$30.49
GSX-R1100	89-92	C8322	78mm	MLS/C.O.T. .030"	\$87.73	C8372	3.370"	.010" RC	\$30.72	C8081AFM	\$30.49
GSX-R1100	89-92	C8037	80mm	CFM-20	\$54.34	C8297	3.370"	.005" Copper	\$35.38	C8081AFM	\$30.49
GSX-R1100	89-92	C8037	80mm	CFM-20	\$54.34	C8069	3.370"	.010" Copper	\$35.38	C8081AFM	\$30.49
GSX-R1100	89-92	C8037	80mm	CFM-20	\$54.34	C8462	3.370"	.020" Copper	\$35.38	C8081AFM	\$30.49
GSX-R1100	89-92	C8037	80mm	CFM-20	\$54.34	C8298	3.370"	.020" Fiber	\$13.97	C8081AFM	\$30.49
GSX-R1100	89-92	C8037	80mm	CFM-20	\$54.34	C8372	3.370"	.010" RC	\$30.72	C8081AFM	\$30.49
GSX-R1100	89-92	C8190	80mm	Copper .032"	\$65.64	C8297	3.370"	.005" Copper	\$35.38	C8081AFM	\$30.49
GSX-R1100	89-92	C8190	80mm	Copper .032"	\$65.64	C8069	3.370"	.010" Copper	\$35.38	C8081AFM	\$30.49
GSX-R1100	89-92	C8190	80mm	Copper .032"	\$65.64	C8462	3.370"	.020" Copper	\$35.38	C8081AFM	\$30.49
GSX-R1100	89-92	C8190	80mm	Copper .032"	\$65.64	C8298	3.370"	.020" Fiber	\$13.97	C8081AFM	\$30.49
GSX-R1100	89-92	C8190	80mm	Copper .032"	\$65.64	C8372	3.370"	.010" RC	\$30.72	C8081AFM	\$30.49
GSX-R1100	89-92	C8368	80mm	MLS/C.O.T. .030"	\$87.73	C8297	3.370"	.005" Copper	\$35.38	C8081AFM	\$30.49
GSX-R1100	89-92	C8368	80mm	MLS/C.O.T. .030"	\$87.73	C8069	3.370"	.010" Copper	\$35.38	C8081AFM	\$30.49
GSX-R1100	89-92	C8368	80mm	MLS/C.O.T. .030"	\$87.73	C8462	3.370"	.020" Copper	\$35.38	C8081AFM	\$30.49
GSX-R1100	89-92	C8368	80mm	MLS/C.O.T. .030"	\$87.73	C8298	3.370"	.020" Fiber	\$13.97	C8081AFM	\$30.49
GSX-R1100	89-92	C8368	80mm	MLS/C.O.T. .030"	\$87.73	C8372	3.370"	.010" RC	\$30.72	C8081AFM	\$30.49
GSX-R1100	89-92	C8191	81mm	Copper .032"	\$65.64	C8203	3.460"	.005" Copper	\$35.38	C8081AFM	\$30.49
GSX-R1100	89-92	C8191	81mm	Copper .032"	\$65.64	C8070	3.460"	.010" Copper	\$35.38	C8081AFM	\$30.49
GSX-R1100	89-92	C8191	81mm	Copper .032"	\$65.64	C8526	3.460"	.020" Copper	\$35.38	C8081AFM	\$30.49
GSX-R1100	89-92	C8191	81mm	Copper .032"	\$65.64	C8373	3.460"	.010" RC	\$30.72	C8081AFM	\$30.49
GSX-R1100	89-92	C8279	81mm	MLS/C.O.T. .030"	\$87.73	C8203	3.460"	.005" Copper	\$35.38	C8081AFM	\$30.49
GSX-R1100	89-92	C8279	81mm	MLS/C.O.T. .030"	\$87.73	C8070	3.460"	.010" Copper	\$35.38	C8081AFM	\$30.49
GSX-R1100	89-92	C8279	81mm	MLS/C.O.T. .030"	\$87.73	C8526	3.460"	.020" Copper	\$35.38	C8081AFM	\$30.49
GSX-R1100	89-92	C8279	81mm	MLS/C.O.T. .030"	\$87.73	C8373	3.460"	.010" RC	\$30.72	C8081AFM	\$30.49
GSX-R1100	89-92	C8243	82mm	Copper .032"	\$65.64	C8203	3.460"	.005" Copper	\$35.38	C8081AFM	\$30.49
GSX-R1100	89-92	C8243	82mm	Copper .032"	\$65.64	C8070	3.460"	.010" Copper	\$35.38	C8081AFM	\$30.49
GSX-R1100	89-92	C8243	82mm	Copper .032"	\$65.64	C8526	3.460"	.020" Copper	\$35.38	C8081AFM	\$30.49
GSX-R1100	89-92	C8243	82mm	Copper .032"	\$65.64	C8373	3.460"	.010" RC	\$30.72	C8081AFM	\$30.49
GSX-R1100	89-92	C8391	82mm	MLS/C.O.T. .030"	\$87.73	C8203	3.460"	.005" Copper	\$35.38	C8081AFM	\$30.49
GSX-R1100	89-92	C8391	82mm	MLS/C.O.T. .030"	\$87.73	C8070	3.460"	.010" Copper	\$35.38	C8081AFM	\$30.49
GSX-R1100	89-92	C8391	82mm	MLS/C.O.T. .030"	\$87.73	C8526	3.460"	.020" Copper	\$35.38	C8081AFM	\$30.49







# STREET-ROAD RACE-STRIP



Cometic Gasket - An Exclusive NASCAR Performance® Product

## SUZUKI

Model	Year	Head Gasket Part#	Bore	Material/Thickness	Price	Base Gasket Part#	Bore	Material/Thickness	Price	Case Kit Part#	Price
GSX-R1100	89-92	C8391	82mm	MLS/C.O.T. .030"	\$87.73	C8373	3.460"	.010" RC	\$30.72	C8081AFM	\$30.49
GSX-R1100	89-92	C8036	83mm	CFM-20	\$54.34	C8246	3.560"	.005" Copper	\$35.38	C8081AFM	\$30.49
GSX-R1100	89-92	C8036	83mm	CFM-20	\$54.34	C8247	3.560"	.010" Copper	\$35.38	C8081AFM	\$30.49
GSX-R1100	89-92	C8036	83mm	CFM-20	\$54.34	C8446	3.560"	.020" Copper	\$35.38	C8081AFM	\$30.49
GSX-R1100	89-92	C8036	83mm	CFM-20	\$54.34	C8374	3.560"	.010" RC	\$30.72	C8081AFM	\$30.49
GSX-R1100	89-92	C8192	83mm	Copper .032"	\$65.64	C8246	3.560"	.005" Copper	\$35.38	C8081AFM	\$30.49
GSX-R1100	89-92	C8192	83mm	Copper .032"	\$65.64	C8247	3.560"	.010" Copper	\$35.38	C8081AFM	\$30.49
GSX-R1100	89-92	C8192	83mm	Copper .032"	\$65.64	C8446	3.560"	.020" Copper	\$35.38	C8081AFM	\$30.49
GSX-R1100	89-92	C8391	82mm	MLS/C.O.T. .030"	\$87.73	C8373	3.460"	.010" RC	\$30.72	C8081AFM	\$30.49
GSX-R1100	89-92	C8036	83mm	CFM-20	\$54.34	C8246	3.560"	.005" Copper	\$35.38	C8081AFM	\$30.49
GSX-R1100	89-92	C8036	83mm	CFM-20	\$54.34	C8247	3.560"	.010" Copper	\$35.38	C8081AFM	\$30.49
GSX-R1100	89-92	C8036	83mm	CFM-20	\$54.34	C8446	3.560"	.020" Copper	\$35.38	C8081AFM	\$30.49
GSX-R1100	89-92	C8036	83mm	CFM-20	\$54.34	C8374	3.560"	.010" RC	\$30.72	C8081AFM	\$30.49
GSX-R1100	89-92	C8192	83mm	Copper .032"	\$65.64	C8246	3.560"	.005" Copper	\$35.38	C8081AFM	\$30.49
GSX-R1100	89-92	C8192	83mm	Copper .032"	\$65.64	C8247	3.560"	.010" Copper	\$35.38	C8081AFM	\$30.49
GSX-R1100	89-92	C8192	83mm	Copper .032"	\$65.64	C8446	3.560"	.020" Copper	\$35.38	C8081AFM	\$30.49
GSX-R1100	89-92	C8192	83mm	Copper .032"	\$65.64	C8374	3.560"	.010" RC	\$30.72	C8081AFM	\$30.49
GSX-R1100	89-92	C8323	83mm	MLS/C.O.T. .030"	\$87.73	C8246	3.560"	.005" Copper	\$35.38	C8081AFM	\$30.49
GSX-R1100	89-92	C8323	83mm	MLS/C.O.T. .030"	\$87.73	C8247	3.560"	.010" Copper	\$35.38	C8081AFM	\$30.49
GSX-R1100	89-92	C8323	83mm	MLS/C.O.T. .030"	\$87.73	C8446	3.560"	.020" Copper	\$35.38	C8081AFM	\$30.49
GSX-R1100	89-92	C8323	83mm	MLS/C.O.T. .030"	\$87.73	C8374	3.560"	.010" RC	\$30.72	C8081AFM	\$30.49
GSX-R1100	89-92	C8340	85mm	MLS/C.O.T. .030"	\$83.52	C8246	3.560"	.005" Copper	\$35.38	C8081AFM	\$30.49
GSX-R1100	89-92	C8340	85mm	MLS/C.O.T. .030"	\$83.52	C8247	3.560"	.010" Copper	\$35.38	C8081AFM	\$30.49
GSX-R1100	89-92	C8340	85mm	MLS/C.O.T. .030"	\$83.52	C8446	3.560"	.020" Copper	\$35.38	C8081AFM	\$30.49
GSX-R1100	89-92	C8340	85mm	MLS/C.O.T. .030"	\$83.52	C8374	3.560"	.010" RC	\$30.72	C8081AFM	\$30.49
GSX-R1100	89-92	C8437	85mm	Copper .032"	\$65.64	C8246	3.560"	.005" Copper	\$35.38	C8081AFM	\$30.49
GSX-R1100	89-92	C8437	85mm	Copper .032"	\$65.64	C8247	3.560"	.010" Copper	\$35.38	C8081AFM	\$30.49
GSX-R1100	89-92	C8437	85mm	Copper .032"	\$65.64	C8446	3.560"	.020" Copper	\$35.38	C8081AFM	\$30.49
GSX-R1100	89-92	C8437	85mm	Copper .032"	\$65.64	C8374	3.560"	.010" RC	\$30.72	C8081AFM	\$30.49
GSX-R1100	89-92	C8194	85mm	Copper .032"	\$65.64	C8246	3.560"	.005" Copper	\$35.38	C8081AFM	\$30.49
GSX-R1100	89-92	C8194	85mm	Copper .032"	\$65.64	C8247	3.560"	.010" Copper	\$35.38	C8081AFM	\$30.49
GSX-R1100	89-92	C8194	85mm	Copper .032"	\$65.64	C8446	3.560"	.020" Copper	\$35.38	C8081AFM	\$30.49
GSX-R1100	89-92	C8194	85mm	Copper .032"	\$65.64	C8374	3.560"	.010" RC	\$30.72	C8081AFM	\$30.49
GSX-R1100	89-92	C8195	86mm	Copper .032"	\$65.64					C8081AFM	\$30.49
GSX-R1100W Water Cooled	93-98	C8280	77 mm	MLS/C.O.T. .030"	\$83.52	C8370	3.265"	.010" RC	\$29.24	C8144	\$19.87
GSX-R1100W Water Cooled	93-98	C8280	77 mm	MLS/C.O.T. .030"	\$83.52	C8307	3.310"	.005" Copper	\$33.68	C8144	\$19.87
GSX-R1100W Water Cooled	93-98	C8280	77 mm	MLS/C.O.T. .030"	\$83.52	C8308	3.310"	.010" Copper	\$33.68	C8144	\$19.87
GSX-R1100W Water Cooled	93-98	C8280	77 mm	MLS/C.O.T. .030"	\$83.52	C8444	3.310"	.020" Copper	\$33.68	C8144	\$19.87
GSX-R1100W Water Cooled	93-98	C8280	77 mm	MLS/C.O.T. .030"	\$83.52	C8309	3.310"	.020" Fiber	\$13.29	C8144	\$19.87
GSX-R1100W Water Cooled	93-98	C8280	77 mm	MLS/C.O.T. .030"	\$83.52	C8371	3.310"	.010" RC	\$29.24	C8144	\$19.87
GSX-R1100W Water Cooled	93-98	C8281	79.5 mm	MLS/C.O.T. .030"	\$83.52	C8307	3.310"	.005" Copper	\$33.68	C8144	\$19.87
GSX-R1100W Water Cooled	93-98	C8281	79.5 mm	MLS/C.O.T. .030"	\$83.52	C8308	3.310"	.010" Copper	\$33.68	C8144	\$19.87
GSX-R1100W Water Cooled	93-98	C8281	79.5 mm	MLS/C.O.T. .030"	\$83.52	C8444	3.310"	.020" Copper	\$33.68	C8144	\$19.87
GSX-R1100W Water Cooled	93-98	C8281	79.5 mm	MLS/C.O.T. .030"	\$83.52	C8309	3.310"	.020" Fiber	\$13.29	C8144	\$19.87
GSX-R1100W Water Cooled	93-98	C8281	79.5 mm	MLS/C.O.T. .030"	\$83.52	C8371	3.310"	.010" RC	\$29.24	C8144	\$19.87
GSX-R1100W Water Cooled	93-98	C8478	78 mm	MLS/C.O.T. .030"	\$83.52	C8307	3.310"	.005" Copper	\$33.68	C8144	\$19.87
GSX-R1100W Water Cooled	93-98	C8478	78 mm	MLS/C.O.T. .030"	\$83.52	C8308	3.310"	.010" Copper	\$33.68	C8144	\$19.87
GSX-R1100W Water Cooled	93-98	C8478	78 mm	MLS/C.O.T. .030"	\$83.52	C8444	3.310"	.020" Copper	\$33.68	C8144	\$19.87
GSX-R1100W Water Cooled	93-98	C8478	78 mm	MLS/C.O.T. .030"	\$83.52	C8309	3.310"	.020" Fiber	\$13.29	C8144	\$19.87
GSX-R1100W Water Cooled	93-98	C8478	78 mm	MLS/C.O.T. .030"	\$83.52	C8371	3.310"	.010" RC	\$29.24	C8144	\$19.87
GSX-R1100W Water Cooled	93-98	C8479	78 mm	Copper .032"	\$62.51	C8307	3.310"	.005" Copper	\$33.68	C8144	\$19.87
GSX-R1100W Water Cooled	93-98	C8479	78 mm	Copper .032"	\$62.51	C8308	3.310"	.010" Copper	\$33.68	C8144	\$19.87
GSX-R1100W Water Cooled	93-98	C8479	78 mm	Copper .032"	\$62.51	C8444	3.310"	.020" Copper	\$33.68	C8144	\$19.87
GSX-R1100W Water Cooled	93-98	C8479	78 mm	Copper .032"	\$62.51	C8309	3.310"	.020" Fiber	\$13.29	C8144	\$19.87
GSX-R1100W Water Cooled	93-98	C8479	78 mm	Copper .032"	\$62.51	C8371	3.310"	.010" RC	\$29.24	C8144	\$19.87
GSX-R1100W Water Cooled	93-98	C8480	79.5 mm	Copper .032"	\$62.51	C8307	3.310"	.005" Copper	\$33.68	C8144	\$19.87
GSX-R1100W Water Cooled	93-98	C8480	79.5 mm	Copper .032"	\$62.51	C8308	3.310"	.010" Copper	\$33.68	C8144	\$19.87
GSX-R1100W Water Cooled	93-98	C8480	79.5 mm	Copper .032"	\$62.51	C8444	3.310"	.020" Copper	\$33.68	C8144	\$19.87
GSX-R1100W Water Cooled	93-98	C8480	79.5 mm	Copper .032"	\$62.51	C8309	3.310"	.020" Fiber	\$13.29	C8144	\$19.87
GSX-R1100W Water Cooled	93-98	C8480	79.5 mm	Copper .032"	\$62.51	C8371	3.310"	.010" RC	\$29.24	C8144	\$19.87
GSX-R1100W Water Cooled	93-98	C8481	79.75 mm	Copper .032"	\$62.51	C8307	3.310"	.005" Copper	\$33.68	C8144	\$19.87
GSX-R1100W Water Cooled	93-98	C8481	79.75 mm	Copper .032"	\$62.51	C8308	3.310"	.010" Copper	\$33.68	C8144	\$19.87
GSX-R1100W Water Cooled	93-98	C8481	79.75 mm	Copper .032"	\$62.51	C8444	3.310"	.020" Copper	\$33.68	C8144	\$19.87
GSX-R1100W Water Cooled	93-98	C8481	79.75 mm	Copper .032"	\$62.51	C8309	3.310"	.020" Fiber	\$13.29	C8144	\$19.87
GSX-R1100W Water Cooled	93-98	C8481	79.75 mm	Copper .032"	\$62.51	C8371	3.310"	.010" RC	\$29.24	C8144	\$19.87







# STREET-ROAD RACE-STRIP



Cometic Gasket - An Exclusive NASCAR Performance® Product

## SUZUKI

Model	Year	Head Gasket Part#	Bore	Material/Thickness	Price	Base Gasket Part#	Bore	Material/Thickness	Price	Case Kit Part#	Price
GSX1100F Katana	88-93	C8189	78mm	Copper .032"	\$65.64	C8297	3.370"	.005" Copper	\$35.38	C8081AFM	\$30.49
GSX1100F Katana	88-93	C8189	78mm	Copper .032"	\$65.64	C8069	3.370"	.010" Copper	\$35.38	C8081AFM	\$30.49
GSX1100F Katana	88-93	C8189	78mm	Copper .032"	\$65.64	C8462	3.370"	.020" Copper	\$35.38	C8081AFM	\$30.49
GSX1100F Katana	88-93	C8189	78mm	Copper .032"	\$65.64	C8298	3.370"	.020" Fiber	\$13.97	C8081AFM	\$30.49
GSX1100F Katana	88-93	C8189	78mm	Copper .032"	\$65.64	C8372	3.370"	.010" RC	\$30.72	C8081AFM	\$30.49
GSX1100F Katana	88-93	C8322	78mm	MLS/C.O.T. .030"	\$87.73	C8297	3.370"	.005" Copper	\$35.38	C8081AFM	\$30.49
GSX1100F Katana	88-93	C8322	78mm	MLS/C.O.T. .030"	\$87.73	C8069	3.370"	.010" Copper	\$35.38	C8081AFM	\$30.49
GSX1100F Katana	88-93	C8322	78mm	MLS/C.O.T. .030"	\$87.73	C8462	3.370"	.020" Copper	\$35.38	C8081AFM	\$30.49
GSX1100F Katana	88-93	C8322	78mm	MLS/C.O.T. .030"	\$87.73	C8298	3.370"	.020" Fiber	\$13.97	C8081AFM	\$30.49
GSX1100F Katana	88-93	C8322	78mm	MLS/C.O.T. .030"	\$87.73	C8372	3.370"	.010" RC	\$30.72	C8081AFM	\$30.49
GSX1100F Katana	88-93	C8037	80mm	CFM-20 .043"	\$54.34	C8297	3.370"	.005" Copper	\$35.38	C8081AFM	\$30.49
GSX1100F Katana	88-93	C8037	80mm	CFM-20 .043"	\$54.34	C8069	3.370"	.010" Copper	\$35.38	C8081AFM	\$30.49
GSX1100F Katana	88-93	C8037	80mm	CFM-20 .043"	\$54.34	C8462	3.370"	.020" Copper	\$35.38	C8081AFM	\$30.49
GSX1100F Katana	88-93	C8037	80mm	CFM-20 .043"	\$54.34	C8298	3.370"	.020" Fiber	\$13.97	C8081AFM	\$30.49
GSX1100F Katana	88-93	C8037	80mm	CFM-20 .043"	\$54.34	C8372	3.370"	.010" RC	\$30.72	C8081AFM	\$30.49
GSX1100F Katana	88-93	C8190	80mm	Copper .032"	\$65.64	C8297	3.370"	.005" Copper	\$35.38	C8081AFM	\$30.49
GSX1100F Katana	88-93	C8190	80mm	Copper .032"	\$65.64	C8069	3.370"	.010" Copper	\$35.38	C8081AFM	\$30.49
GSX1100F Katana	88-93	C8190	80mm	Copper .032"	\$65.64	C8462	3.370"	.020" Copper	\$35.38	C8081AFM	\$30.49
GSX1100F Katana	88-93	C8190	80mm	Copper .032"	\$65.64	C8298	3.370"	.020" Fiber	\$13.97	C8081AFM	\$30.49
GSX1100F Katana	88-93	C8190	80mm	Copper .032"	\$65.64	C8372	3.370"	.010" RC	\$30.72	C8081AFM	\$30.49
GSX1100F Katana	88-93	C8368	80mm	MLS/C.O.T. .030"	\$87.73	C8297	3.370"	.005" Copper	\$35.38	C8081AFM	\$30.49
GSX1100F Katana	88-93	C8368	80mm	MLS/C.O.T. .030"	\$87.73	C8069	3.370"	.010" Copper	\$35.38	C8081AFM	\$30.49
GSX1100F Katana	88-93	C8368	80mm	MLS/C.O.T. .030"	\$87.73	C8462	3.370"	.020" Copper	\$35.38	C8081AFM	\$30.49
GSX1100F Katana	88-93	C8368	80mm	MLS/C.O.T. .030"	\$87.73	C8298	3.370"	.020" Fiber	\$13.97	C8081AFM	\$30.49
GSX1100F Katana	88-93	C8368	80mm	MLS/C.O.T. .030"	\$87.73	C8372	3.370"	.010" RC	\$30.72	C8081AFM	\$30.49
GSX1100F Katana	88-93	C8191	81mm	Copper .032"	\$65.64	C8203	3.460"	.005" Copper	\$35.38	C8081AFM	\$30.49
GSX1100F Katana	88-93	C8191	81mm	Copper .032"	\$65.64	C8070	3.460"	.010" Copper	\$35.38	C8081AFM	\$30.49
GSX1100F Katana	88-93	C8191	81mm	Copper .032"	\$65.64	C8526	3.460"	.020" Copper	\$35.38	C8081AFM	\$30.49
GSX1100F Katana	88-93	C8191	81mm	Copper .032"	\$65.64	C8373	3.460"	.010" RC	\$30.72	C8081AFM	\$30.49
GSX1100F Katana	88-93	C8279	81mm	MLS/C.O.T. .030"	\$87.73	C8203	3.460"	.005" Copper	\$35.38	C8081AFM	\$30.49
GSX1100F Katana	88-93	C8279	81mm	MLS/C.O.T. .030"	\$87.73	C8070	3.460"	.010" Copper	\$35.38	C8081AFM	\$30.49
GSX1100F Katana	88-93	C8279	81mm	MLS/C.O.T. .030"	\$87.73	C8526	3.460"	.020" Copper	\$35.38	C8081AFM	\$30.49
GSX1100F Katana	88-93	C8279	81mm	MLS/C.O.T. .030"	\$87.73	C8373	3.460"	.010" RC	\$30.72	C8081AFM	\$30.49
GSX1100F Katana	88-93	C8243	82mm	Copper .032"	\$65.64	C8203	3.460"	.005" Copper	\$35.38	C8081AFM	\$30.49
GSX1100F Katana	88-93	C8243	82mm	Copper .032"	\$65.64	C8070	3.460"	.010" Copper	\$35.38	C8081AFM	\$30.49
GSX1100F Katana	88-93	C8243	82mm	Copper .032"	\$65.64	C8526	3.460"	.020" Copper	\$35.38	C8081AFM	\$30.49
GSX1100F Katana	88-93	C8243	82mm	Copper .032"	\$65.64	C8373	3.460"	.010" RC	\$30.72	C8081AFM	\$30.49
GSX1100F Katana	88-93	C8036	83mm	CFM-20 .043"	\$54.34	C8246	3.560"	.005" Copper	\$35.38	C8081AFM	\$30.49
GSX1100F Katana	88-93	C8036	83mm	CFM-20 .043"	\$54.34	C8247	3.560"	.010" Copper	\$35.38	C8081AFM	\$30.49
GSX1100F Katana	88-93	C8036	83mm	CFM-20 .043"	\$54.34	C8446	3.560"	.020" Copper	\$35.38	C8081AFM	\$30.49
GSX1100F Katana	88-93	C8036	83mm	CFM-20 .043"	\$54.34	C8374	3.560"	.010" RC	\$30.72	C8081AFM	\$30.49
GSX1100F Katana	88-93	C8192	83mm	Copper .032"	\$65.64	C8246	3.560"	.005" Copper	\$35.38	C8081AFM	\$30.49
GSX1100F Katana	88-93	C8192	83mm	Copper .032"	\$65.64	C8247	3.560"	.010" Copper	\$35.38	C8081AFM	\$30.49
GSX1100F Katana	88-93	C8192	83mm	Copper .032"	\$65.64	C8446	3.560"	.020" Copper	\$35.38	C8081AFM	\$30.49
GSX1100F Katana	88-93	C8192	83mm	Copper .032"	\$65.64	C8374	3.560"	.010" RC	\$30.72	C8081AFM	\$30.49
GSX1100F Katana D Pin	88-93	C8323	83mm	MLS/C.O.T. .030"	\$87.73	C8246	3.560"	.005" Copper	\$35.38	C8081AFM	\$30.49
GSX1100F Katana D Pin	88-93	C8323	83mm	MLS/C.O.T. .030"	\$87.73	C8247	3.560"	.010" Copper	\$35.38	C8081AFM	\$30.49
GSX1100F Katana D Pin	88-93	C8323	83mm	MLS/C.O.T. .030"	\$87.73	C8446	3.560"	.020" Copper	\$35.38	C8081AFM	\$30.49
GSX1100F Katana D Pin	88-93	C8323	83mm	MLS/C.O.T. .030"	\$87.73	C8374	3.560"	.010" RC	\$30.72	C8081AFM	\$30.49
GSX1100F Katana D Pin	88-93	C8340	85mm	MLS/C.O.T. .030"	\$83.52	C8246	3.560"	.005" Copper	\$35.38	C8081AFM	\$30.49
GSX1100F Katana D Pin	88-93	C8340	85mm	MLS/C.O.T. .030"	\$83.52	C8247	3.560"	.010" Copper	\$35.38	C8081AFM	\$30.49
GSX1100F Katana D Pin	88-93	C8340	85mm	MLS/C.O.T. .030"	\$83.52	C8446	3.560"	.020" Copper	\$35.38	C8081AFM	\$30.49
GSX1100F Katana D Pin	88-93	C8340	85mm	MLS/C.O.T. .030"	\$83.52	C8374	3.560"	.010" RC	\$30.72	C8081AFM	\$30.49
GSX1100F Katana 6mm Pin	88-93	C8437	85mm	Copper .032"	\$65.64	C8246	3.560"	.005" Copper	\$35.38	C8081AFM	\$30.49
GSX1100F Katana 6mm Pin	88-93	C8437	85mm	Copper .032"	\$65.64	C8247	3.560"	.010" Copper	\$35.38	C8081AFM	\$30.49
GSX1100F Katana 6mm Pin	88-93	C8437	85mm	Copper .032"	\$65.64	C8446	3.560"	.020" Copper	\$35.38	C8081AFM	\$30.49
GSX1100F Katana 6mm Pin	88-93	C8437	85mm	Copper .032"	\$65.64	C8374	3.560"	.010" RC	\$30.72	C8081AFM	\$30.49
GSX1100F Katana D Pin	88-93	C8194	85mm	Copper .032"	\$65.64	C8246	3.560"	.005" Copper	\$35.38	C8081AFM	\$30.49
GSX1100F Katana D Pin	88-93	C8194	85mm	Copper .032"	\$65.64	C8247	3.560"	.010" Copper	\$35.38	C8081AFM	\$30.49
GSX1100F Katana D Pin	88-93	C8194	85mm	Copper .032"	\$65.64	C8446	3.560"	.020" Copper	\$35.38	C8081AFM	\$30.49
GSX1100F Katana D Pin	88-93	C8194	85mm	Copper .032"	\$65.64	C8374	3.560"	.010" RC	\$30.72	C8081AFM	\$30.49









# STREET-ROAD RACE-STRIP



Cometic Gasket - An Exclusive NASCAR Performance® Product

## SUZUKI

Model	Year	Head Gasket Part#	Bore	Material/Thickness	Price	Base Gasket Part#	Bore	Material/Thickness	Price	Case Kit Part#	Price
GSX1100F Katana 6mm Pin	88-93	C8195	86mm	Copper .032"	\$65.64					C8081AFM	\$30.49
GS1150E 11mm Pin	84-86	C8185	75 mm	Copper .043"	\$65.64	C8109	3.130"	.020" Fiber	\$13.29	C8073	\$15.90
GS1150E 11mm Pin	84-86	C8185	75 mm	Copper .043"	\$65.64	C8110	3.130"	.005" Copper	\$33.68	C8073	\$15.90
GS1150E 11mm Pin	84-86	C8185	75 mm	Copper .043"	\$65.64	C8111	3.130"	.010" Copper	\$33.68	C8073	\$15.90
GS1150E 11mm Pin	84-86	C8185	75 mm	Copper .043"	\$65.64	C8112	3.130"	.020" Copper	\$33.68	C8073	\$15.90
GS1150E 11mm Pin	84-86	C8728-045	75mm	MLS/C.O.T. .045"	\$87.73	C8109	3.130"	.020" Fiber	\$13.29	C8073	\$15.90
GS1150E 11mm Pin	84-86	C8728-045	75mm	MLS/C.O.T. .045"	\$87.73	C8110	3.130"	.005" Copper	\$33.68	C8073	\$15.90
GS1150E 11mm Pin	84-86	C8728-045	75mm	MLS/C.O.T. .045"	\$87.73	C8111	3.130"	.010" Copper	\$33.68	C8073	\$15.90
GS1150E 11mm Pin	84-86	C8728-045	75mm	MLS/C.O.T. .045"	\$87.73	C8112	3.130"	.020" Copper	\$33.68	C8073	\$15.90
GS1150E 11mm Pin	84-86	C8165	76 mm	Copper .043"	\$65.64	C8113	3.290"	.020" Fiber	\$13.29	C8073	\$15.90
GS1150E 11mm Pin	84-86	C8165	76 mm	Copper .043"	\$65.64	C8114	3.290"	.005" Copper	\$33.68	C8073	\$15.90
GS1150E 11mm Pin	84-86	C8165	76 mm	Copper .043"	\$65.64	C8115	3.290"	.010" Copper	\$33.68	C8073	\$15.90
GS1150E 11mm Pin	84-86	C8165	76 mm	Copper .043"	\$65.64	C8116	3.290"	.020" Copper	\$33.68	C8073	\$15.90
GS1150E 11mm Pin	84-86	C8729-045	76 mm	MLS/C.O.T. .045"	\$87.73	C8113	3.290"	.020" Fiber	\$13.29	C8073	\$15.90
GS1150E 11mm Pin	84-86	C8729-045	76 mm	MLS/C.O.T. .045"	\$87.73	C8114	3.290"	.005" Copper	\$33.68	C8073	\$15.90
GS1150E 11mm Pin	84-86	C8729-045	76 mm	MLS/C.O.T. .045"	\$87.73	C8115	3.290"	.010" Copper	\$33.68	C8073	\$15.90
GS1150E 11mm Pin	84-86	C8729-045	76 mm	MLS/C.O.T. .045"	\$87.73	C8116	3.290"	.020" Copper	\$33.68	C8073	\$15.90
GS1150E 11mm Pin	84-86	C8186	77 mm	Copper .043"	\$65.64	C8113	3.290"	.020" Fiber	\$13.29	C8073	\$15.90
GS1150E 11mm Pin	84-86	C8186	77 mm	Copper .043"	\$65.64	C8114	3.290"	.005" Copper	\$33.68	C8073	\$15.90
GS1150E 11mm Pin	84-86	C8186	77 mm	Copper .043"	\$65.64	C8115	3.290"	.010" Copper	\$33.68	C8073	\$15.90
GS1150E 11mm Pin	84-86	C8186	77 mm	Copper .043"	\$65.64	C8116	3.290"	.020" Copper	\$33.68	C8073	\$15.90
GS1150E 11mm Pin	84-86	C8166	78 mm	Copper .043"	\$65.64	C8113	3.290"	.020" Fiber	\$13.29	C8073	\$15.90
GS1150E 11mm Pin	84-86	C8166	78 mm	Copper .043"	\$65.64	C8114	3.290"	.005" Copper	\$33.68	C8073	\$15.90
GS1150E 11mm Pin	84-86	C8166	78 mm	Copper .043"	\$65.64	C8115	3.290"	.010" Copper	\$33.68	C8073	\$15.90
GS1150E 11mm Pin	84-86	C8166	78 mm	Copper .043"	\$65.64	C8116	3.290"	.020" Copper	\$33.68	C8073	\$15.90
GS1150E 11mm Pin	84-86	C8167	79 mm	Copper .043"	\$65.64	C8113	3.290"	.020" Fiber	\$13.29	C8073	\$15.90
GS1150E 11mm Pin	84-86	C8167	79 mm	Copper .043"	\$65.64	C8114	3.290"	.005" Copper	\$33.68	C8073	\$15.90
GS1150E 11mm Pin	84-86	C8167	79 mm	Copper .043"	\$65.64	C8115	3.290"	.010" Copper	\$33.68	C8073	\$15.90
GS1150E 11mm Pin	84-86	C8167	79 mm	Copper .043"	\$65.64	C8116	3.290"	.020" Copper	\$33.68	C8073	\$15.90
GS1150E 11mm Pin	84-86	C8730-045	79 mm	MLS/C.O.T. .045"	\$87.73	C8113	3.290"	.020" Fiber	\$13.29	C8073	\$15.90
GS1150E 11mm Pin	84-86	C8730-045	79 mm	MLS/C.O.T. .045"	\$87.73	C8114	3.290"	.005" Copper	\$33.68	C8073	\$15.90
GS1150E 11mm Pin	84-86	C8730-045	79 mm	MLS/C.O.T. .045"	\$87.73	C8115	3.290"	.010" Copper	\$33.68	C8073	\$15.90
GS1150E 11mm Pin	84-86	C8730-045	79 mm	MLS/C.O.T. .045"	\$87.73	C8116	3.290"	.020" Copper	\$33.68	C8073	\$15.90
GS1150E 11mm Pin	84-86	C8168	80 mm	Copper .043"	\$65.64	C8177	3.460"	.005" Copper	\$33.68	C8073	\$15.90
GS1150E 11mm Pin	84-86	C8168	80 mm	Copper .043"	\$65.64	C8178	3.460"	.010" Copper	\$33.68	C8073	\$15.90
GS1150E 11mm Pin	84-86	C8168	80 mm	Copper .043"	\$65.64	C8179	3.460"	.020" Copper	\$33.68	C8073	\$15.90
GS1150E 11mm Pin	84-86	C8168	80 mm	Copper .043"	\$65.64	C8180	3.460"	.020" Fiber	\$13.29	C8073	\$15.90
GS1150E 11mm Pin	84-86	C8731-045	80 mm	MLS/C.O.T. .045"	\$87.73	C8177	3.460"	.005" Copper	\$33.68	C8073	\$15.90
GS1150E 11mm Pin	84-86	C8731-045	80 mm	MLS/C.O.T. .045"	\$87.73	C8178	3.460"	.010" Copper	\$33.68	C8073	\$15.90
GS1150E 11mm Pin	84-86	C8731-045	80 mm	MLS/C.O.T. .045"	\$87.73	C8179	3.460"	.020" Copper	\$33.68	C8073	\$15.90
GS1150E 11mm Pin	84-86	C8731-045	80 mm	MLS/C.O.T. .045"	\$87.73	C8180	3.460"	.020" Fiber	\$13.29	C8073	\$15.90
GS1150E D Pin	84-86	C8470	82 mm	Copper .043"	\$65.64	C8177	3.460"	.005" Copper	\$33.68	C8073	\$15.90
GS1150E D Pin	84-86	C8470	82 mm	Copper .043"	\$65.64	C8178	3.460"	.010" Copper	\$33.68	C8073	\$15.90
GS1150E D Pin	84-86	C8470	82 mm	Copper .043"	\$65.64	C8179	3.460"	.020" Copper	\$33.68	C8073	\$15.90
GS1150E D Pin	84-86	C8470	82 mm	Copper .043"	\$65.64	C8180	3.460"	.020" Fiber	\$13.29	C8073	\$15.90
GS1150E 11mm Pin	84-86	C8169	82 mm	Copper .043"	\$65.64	C8177	3.460"	.005" Copper	\$33.68	C8073	\$15.90
GS1150E 11mm Pin	84-86	C8169	82 mm	Copper .043"	\$65.64	C8178	3.460"	.010" Copper	\$33.68	C8073	\$15.90
GS1150E 11mm Pin	84-86	C8169	82 mm	Copper .043"	\$65.64	C8179	3.460"	.020" Copper	\$33.68	C8073	\$15.90
GS1150E 11mm Pin	84-86	C8169	82 mm	Copper .043"	\$65.64	C8180	3.460"	.020" Fiber	\$13.29	C8073	\$15.90
GS1150E D Pin	84-86	C8471	83 mm	Copper .043"	\$65.64	C8117	3.560"	.020" Fiber	\$13.29	C8073	\$15.90
GS1150E D Pin	84-86	C8471	83 mm	Copper .043"	\$65.64	C8118	3.560"	.005" Copper	\$33.68	C8073	\$15.90
GS1150E D Pin	84-86	C8471	83 mm	Copper .043"	\$65.64	C8119	3.560"	.010" Copper	\$33.68	C8073	\$15.90
GS1150E D Pin	84-86	C8471	83 mm	Copper .043"	\$65.64	C8120	3.560"	.020" Copper	\$33.68	C8073	\$15.90
GS1150E 11mm Pin	84-86	C8170	83 mm	Copper .043"	\$65.64	C8117	3.560"	.020" Fiber	\$12.65	C8073	\$15.90
GS1150E 11mm Pin	84-86	C8170	83 mm	Copper .043"	\$65.64	C8118	3.560"	.005" Copper	\$33.68	C8073	\$15.90
GS1150E 11mm Pin	84-86	C8170	83 mm	Copper .043"	\$65.64	C8119	3.560"	.010" Copper	\$33.68	C8073	\$15.90
GS1150E 11mm Pin	84-86	C8170	83 mm	Copper .043"	\$65.64	C8120	3.560"	.020" Copper	\$33.68	C8073	\$15.90
GS1150E D Pin	84-86	C8732-045	83 mm	MLS/C.O.T. .045"	\$87.73	C8117	3.560"	.020" Fiber	\$13.29	C8073	\$15.90
GS1150E D Pin	84-86	C8732-045	83 mm	MLS/C.O.T. .045"	\$87.73	C8118	3.560"	.005" Copper	\$33.68	C8073	\$15.90
GS1150E D Pin	84-86	C8732-045	83 mm	MLS/C.O.T. .045"	\$87.73	C8119	3.560"	.010" Copper	\$33.68	C8073	\$15.90
GS1150E D Pin	84-86	C8732-045	83 mm	MLS/C.O.T. .045"	\$87.73	C8120	3.560"	.020" Copper	\$33.68	C8073	\$15.90
GS1150E 11mm Pin	84-86	C8035	84 mm	Fiber .043"	\$54.34	C8117	3.560"	.020" Fiber	\$13.29	C8073	\$15.90
GS1150E 11mm Pin	84-86	C8035	84 mm	Fiber .043"	\$54.34	C8118	3.560"	.005" Copper	\$33.68	C8073	\$15.90
GS1150E 11mm Pin	84-86	C8035	84 mm	Fiber .043"	\$54.34	C8119	3.560"	.010" Copper	\$33.68	C8073	\$15.90
GS1150E 11mm Pin	84-86	C8035	84 mm	Fiber .043"	\$54.34	C8120	3.560"	.020" Copper	\$33.68	C8073	\$15.90









# STREET-ROAD RACE-STRIP



Cometic Gasket - An Exclusive NASCAR Performance® Product

## SUZUKI

Model	Year	Head Gasket Part#	Bore	Material/Thickness	Price	Base Gasket Part#	Bore	Material/Thickness	Price	Case Kit Part#	Price
GS1150E 6mm Pin	84-86	C8187	85 mm	Copper .043"	\$65.64	C8117	3.560"	.020" Fiber	\$13.29	C8073	\$15.90
GS1150E 6mm Pin	84-86	C8187	85 mm	Copper .043"	\$65.64	C8118	3.560"	.005" Copper	\$33.68	C8073	\$15.90
GS1150E 6mm Pin	84-86	C8187	85 mm	Copper .043"	\$65.64	C8119	3.560"	.010" Copper	\$33.68	C8073	\$15.90
GS1150E 6mm Pin	84-86	C8187	85 mm	Copper .043"	\$65.64	C8120	3.560"	.020" Copper	\$33.68	C8073	\$15.90
GS1150E 8mm Pin	84-86	C8439	85 mm	Copper .043"	\$65.64	C8117	3.560"	.020" Fiber	\$12.65	C8073	\$15.90
GS1150E 8mm Pin	84-86	C8439	85 mm	Copper .043"	\$65.64	C8118	3.560"	.005" Copper	\$33.68	C8073	\$15.90
GS1150E 8mm Pin	84-86	C8439	85 mm	Copper .043"	\$65.64	C8119	3.560"	.010" Copper	\$33.68	C8073	\$15.90
GS1150E 8mm Pin	84-86	C8439	85 mm	Copper .043"	\$65.64	C8120	3.560"	.020" Copper	\$33.68	C8073	\$15.90
GS1150E D Pin	84-86	C8473	85 mm	Copper .043"	\$65.64	C8117	3.560"	.020" Fiber	\$13.29	C8073	\$15.90
GS1150E D Pin	84-86	C8473	85 mm	Copper .043"	\$65.64	C8118	3.560"	.005" Copper	\$33.68	C8073	\$15.90
GS1150E D Pin	84-86	C8473	85 mm	Copper .043"	\$65.64	C8119	3.560"	.010" Copper	\$33.68	C8073	\$15.90
GS1150E D Pin	84-86	C8473	85 mm	Copper .043"	\$65.64	C8120	3.560"	.020" Copper	\$33.68	C8073	\$15.90
GS1150E D Pin	84-86	C8733-045	85 mm	MLS/C.O.T. .045"	\$87.73	C8117	3.560"	.020" Fiber	\$13.29	C8073	\$15.90
GS1150E D Pin	84-86	C8733-045	85 mm	MLS/C.O.T. .045"	\$87.73	C8118	3.560"	.005" Copper	\$33.68	C8073	\$15.90
GS1150E D Pin	84-86	C8733-045	85 mm	MLS/C.O.T. .045"	\$87.73	C8119	3.560"	.010" Copper	\$33.68	C8073	\$15.90
GS1150E D Pin	84-86	C8733-045	85 mm	MLS/C.O.T. .045"	\$87.73	C8120	3.560"	.020" Copper	\$33.68	C8073	\$15.90
GS1150E 6mm Pin	84-86	C8171	87 mm	Copper .043"	\$65.64	C8117	3.560"	.020" Fiber	\$13.29	C8073	\$15.90
GS1150E 6mm Pin	84-86	C8171	87 mm	Copper .043"	\$65.64	C8118	3.560"	.005" Copper	\$33.68	C8073	\$15.90
GS1150E 6mm Pin	84-86	C8171	87 mm	Copper .043"	\$65.64	C8119	3.560"	.010" Copper	\$33.68	C8073	\$15.90
GS1150E 6mm Pin	84-86	C8171	87 mm	Copper .043"	\$65.64	C8120	3.560"	.020" Copper	\$33.68	C8073	\$15.90
GS1150E 6mm Pin	84-86	C8734-045	87 mm	MLS/C.O.T. .045"	\$87.73	C8117	3.560"	.020" Fiber	\$13.29	C8073	\$15.90
GS1150E 6mm Pin	84-86	C8734-045	87 mm	MLS/C.O.T. .045"	\$87.73	C8118	3.560"	.005" Copper	\$33.68	C8073	\$15.90
GS1150E 6mm Pin	84-86	C8734-045	87 mm	MLS/C.O.T. .045"	\$87.73	C8119	3.560"	.010" Copper	\$33.68	C8073	\$15.90
GS1150E 6mm Pin	84-86	C8734-045	87 mm	MLS/C.O.T. .045"	\$87.73	C8120	3.560"	.020" Copper	\$33.68	C8073	\$15.90
GS1150E	84-86	C8735-045	89 mm	MLS/C.O.T. .045"	\$87.73	C8375	3.660"	.005" Copper	\$33.68	C8073	\$15.90
GS1150E	84-86	C8735-045	89 mm	MLS/C.O.T. .045"	\$87.73	C8376	3.660"	.010" Copper	\$33.68	C8073	\$15.90
GS1150E	84-86	C8735-045	89 mm	MLS/C.O.T. .045"	\$87.73	C8377	3.660"	.020" Copper	\$33.68	C8073	\$15.90
GSF1200SX Bandit	97-05	C8279	81mm	MLS/C.O.T. .030"	\$87.73	B0963010S86mm		.010" RC	\$29.24	C8081AFM	\$30.49
GSF1200SX Bandit	97-05	C8368	80mm	MLS/C.O.T. .030"	\$87.73	B0963010S86mm		.010" RC	\$29.24	C8081AFM	\$30.49
GSF1200SX Bandit 11 mm Pin	97-05	C8391	82mm	MLS/C.O.T. .030"	\$87.73	B0963010S86mm		.010" RC	\$29.24	C8081AFM	\$30.49
GSF1200SX Bandit / D Pin	97-05	C8323	83mm	MLS/C.O.T. .030"	\$87.73	B0963010S86mm		.010" RC	\$29.24	C8081AFM	\$30.49
GSX1300R Hayabusa	99-07	C8656	81mm	MLS/C.O.T. .030"	\$83.52	C8585	93mm	.010" RC	\$29.24	C8587AFM	\$72.97
GSX1300R Hayabusa	99-07	C8656-018	81mm	MLS/C.O.T. .018"	\$95.45	C8585	93mm	.010" RC	\$29.24	C8587AFM	\$72.97
GSX1300R Hayabusa	99-07	C8218	81mm	MLS/C.O.T. .030"	\$83.52	C8747	93mm	.010" RC	\$29.24	C8587AFM	\$72.97
w/13 mm studs											
GSX1300R Hayabusa	99-07	C8660	82mm	MLS/C.O.T. .030"	\$83.52	C8585	93mm	.010" RC	\$29.24	C8587AFM	\$72.97
GSX1300R Hayabusa	99-07	C8657-018	83mm	MLS/C.O.T. .018"	\$95.45	C8585	93mm	.010" RC	\$29.24	C8587AFM	\$72.97
GSX1300R Hayabusa	99-07	C8657	83mm	MLS/C.O.T. .030"	\$83.52	C8585	93mm	.010" RC	\$29.24	C8587AFM	\$72.97
GSX1300R Hayabusa	99-07	C8219	83mm	MLS/C.O.T. .030"	\$83.52	C8747	93mm	.010" RC	\$29.24	C8587AFM	\$72.97
w/13mm studs											
GSX1300R Hayabusa	99-07	C8658	84mm	MLS/C.O.T. .030"	\$83.52	C8585	93mm	.010" RC	\$29.24	C8587AFM	\$72.97
GSX1300R Hayabusa	99-07	C8658-018	84mm	MLS/C.O.T. .018"	\$95.45	C8585	93mm	.010" RC	\$29.24	C8587AFM	\$72.97
GSX1300R Hayabusa	99-07	C8220	84mm	MLS/C.O.T. .030"	\$83.52	C8747	93mm	.010" RC	\$29.24	C8587AFM	\$72.97
w/13mm studs											
GSX1300R Hayabusa	99-07	C8659	85mm	MLS/C.O.T. .030"	\$83.52	C8585	93mm	.010" RC	\$29.24	C8587AFM	\$72.97
GSX1300R Hayabusa	99-07	C8659-018	85mm	MLS/C.O.T. .018"	\$95.45	C8585	93mm	.010" RC	\$29.24	C8587AFM	\$72.97
GSX1300R Hayabusa	99-07	C8913	85mm	MLS/C.O.T. .030"	\$83.52	C8747	93mm	.010" RC	\$29.24	C8587AFM	\$72.97
w/13mm studs											
GSX1300R Hayabusa	99-07	C8913-018	85mm	MLS/C.O.T. .018"	\$83.52	C8747	93mm	.010" RC	\$29.24	C8587AFM	\$72.97
w/13mm studs											
GSX1300R Hayabusa	08-18	C8656	81mm	MLS/C.O.T. .030"	\$83.52	C8585	93mm	.010" RC	\$29.24	C8587AFM	\$72.97
GSX1300R Hayabusa	08-18	C8656-018	81mm	MLS/C.O.T. .018"	\$95.45	C8585	93mm	.010" RC	\$29.24	C8587AFM	\$72.97
GSX1300R Hayabusa	08-18	C8218	81mm	MLS/C.O.T. .030"	\$83.52	C8747	93mm	.010" RC	\$29.24	C8587AFM	\$72.97
w/13mm studs											
GSX1300R Hayabusa	08-18	C8660	82mm	MLS/C.O.T. .030"	\$83.52	C8585	93mm	.010" RC	\$29.24	C8587AFM	\$72.97
GSX1300R Hayabusa	08-18	C8657-018	83mm	MLS/C.O.T. .018"	\$95.45	C8585	93mm	.010" RC	\$29.24	C8587AFM	\$72.97
GSX1300R Hayabusa	08-18	C8657	83mm	MLS/C.O.T. .030"	\$83.52	C8585	93mm	.010" RC	\$29.24	C8587AFM	\$72.97
GSX1300R Hayabusa	08-18	C8219	83mm	MLS/C.O.T. .030"	\$83.52	C8747	93mm	.010" RC	\$29.24	C8587AFM	\$72.97
w/13mm studs											
GSX1300R Hayabusa	08-18	C8658	84mm	MLS/C.O.T. .030"	\$83.52	C8585	93mm	.010" RC	\$29.24	C8587AFM	\$72.97
GSX1300R Hayabusa	08-18	C8658-018	84mm	MLS/C.O.T. .018"	\$95.45	C8585	93mm	.010" RC	\$29.24	C8587AFM	\$72.97

All Component Parts can be purchased individually.



**WARNING:** Cancer and Reproductive Harm [www.P65Warnings.ca.gov](http://www.P65Warnings.ca.gov)





# STREET-ROAD RACE-STRIP



Cometic Gasket - An Exclusive NASCAR Performance® Product

## SUZUKI

Model	Year	Head Gasket Part#	Bore	Material/Thickness	Price	Base Gasket Part#	Bore	Material/Thickness	Price	Case Kit Part#	Price
GSX1300R Hayabusa	08-18	C8220	84mm	MLS/C.O.T. .030"	\$83.52	C8747	93mm	.010" RC	\$29.24	C8587AFM	\$72.97
			w/13mm studs								
GSX1300R Hayabusa	08-18	C8659	85mm	MLS/C.O.T. .030"	\$83.52	C8585	93mm	.010" RC	\$29.24	C8587AFM	\$72.97
GSX1300R Hayabusa	08-18	C8659-018	85mm	MLS/C.O.T. .018"	\$95.45	C8585	93mm	.010" RC	\$29.24	C8587AFM	\$72.97
GSX1300R Hayabusa	08-18	C8913	85mm	MLS/C.O.T. .030"	\$83.52	C8747	93mm	.010" RC	\$29.24	C8587AFM	\$72.97
			w/13mm studs								
GSX1300R Hayabusa	08-18	C8913-018	85mm	MLS/C.O.T. .018"	\$83.52	C8747	93mm	.010" RC	\$29.24	C8587AFM	\$72.97

## TRIUMPH

Model	Year	Head Gasket Part#	Bore	Material/Thickness	Price	Base Gasket Part#	Bore	Material/Thickness	Price	Case Kit Part#	Price
Bonneville T100	06-14	C8850	90mm	MLS/C.O.T. .030"	\$77.46	C8853	105mm	.020" RC	\$25.83		
Scrambler	06-14	C8850	90mm	MLS/C.O.T. .030"	\$77.46	C8853	105mm	.020" RC	\$25.83		
Thruxton	06-14	C8850	90mm	MLS/C.O.T. .030"	\$77.46	C8853	105mm	.020" RC	\$25.83		
Bonneville America	06-14	C8850	90mm	MLS/C.O.T. .030"	\$77.46	C8853	105mm	.020" RC	\$25.83		
Speedmaster	06-14	C8850	90mm	MLS/C.O.T. .030"	\$77.46	C8853	105mm	.020" RC	\$25.83		
Bonneville T100	06-14	C8851	92mm	MLS/C.O.T. .030"	\$77.46	C8853	105mm	.020" RC	\$25.83		
Scrambler	06-14	C8851	92mm	MLS/C.O.T. .030"	\$77.46	C8853	105mm	.020" RC	\$25.83		
Thruxton	06-14	C8851	92mm	MLS/C.O.T. .030"	\$77.46	C8853	105mm	.020" RC	\$25.83		
Bonneville America	06-14	C8851	92mm	MLS/C.O.T. .030"	\$77.46	C8853	105mm	.020" RC	\$25.83		
Speedmaster	06-14	C8851	92mm	MLS/C.O.T. .030"	\$77.46	C8853	105mm	.020" RC	\$25.83		
Bonneville T100	06-14	C8852	96.5mm	MLS/C.O.T. .030"	\$77.46	C8854	106mm	.020" RC	\$25.83		
Scrambler	06-14	C8852	96.5mm	MLS/C.O.T. .030"	\$77.46	C8854	106mm	.020" RC	\$25.83		
Thruxton	06-14	C8852	96.5mm	MLS/C.O.T. .030"	\$77.46	C8854	106mm	.020" RC	\$25.83		
Bonneville America	06-14	C8852	96.5mm	MLS/C.O.T. .030"	\$77.46	C8854	106mm	.020" RC	\$25.83		
Speedmaster	06-19	C8852	96.5mm	MLS/C.O.T. .030"	\$77.46	C8854	106mm	.020" RC	\$25.83		
T100 Bonneville	16-19	C8926	85mm	MLS/C.O.T. .030"	\$77.46	C8928		.010" RC	\$25.83		
T120 Bonneville	16-19	C8927	98mm	MLS/C.O.T. .030"	\$77.46	C8928		.010" RC	\$25.83		
Bonneville Bobber	17-19	C8927	98mm	MLS/C.O.T. .030"	\$77.46	C8928		.010" RC	\$25.83		
Bonneville Speedmaster	18-19	C8927	98mm	MLS/C.O.T. .030"	\$77.46	C8928		.010" RC	\$25.83		
Thruxton 1200	17-19	C8927	8mm	MLS/C.O.T. .030"	\$77.46	C8928		.010" RC	\$25.83		

## YAMAHA

Model	Year	Head Gasket Part#	Bore	Material/Thickness	Price	Base Gasket Part#	Bore	Material/Thickness	Price	Case Kit Part#	Price
YZF-R25	15-16	C8910	68mm	MLS/C.O.T. .018"	47.37						
YZF-R3	15-19	C8908	68mm	MLS/C.O.T. .018"	47.37						
YZF-R3	15-19	C8909	70mm	MLS/C.O.T. .018"	47.37						
RD350	73-75	C8871	66mm	Copper.043"	\$37.19	C8872		.020" Fiber	\$15.32		
RZ350	84-90	C8869	66mm	MLS/C.O.T. .030"	\$37.19	C8868		.020" Fiber	\$13.42		
FZR400	89-97	C8443	58mm	SLS .010"	\$83.52	C8427	65 mm				
FZR600	89-99	C8282	60.5 mm	SLS .010"	\$83.52	C8427	65 mm	.020" Copper	\$33.68	C8402	\$19.87
YZF600R	94-98	C8424	63 mm	SLS .010"	\$87.73	C8427	65 mm	.020" Copper	\$33.68	C8402	\$19.87
YZF600R	97-07	C8424	63 mm	SLS .010"	\$87.73	C8427	65 mm	.020" Copper	\$33.68	C8402	\$19.87
YZF-R6	99-02	C8575	68mm	MLS/C.O.T. .030"	\$83.52					C8612AFM	\$19.87
YZF-R6	99-02	C8575-018	68mm	MLS/C.O.T. .018"	\$100.22					C8612AFM	\$19.87
YZF-R6	03-05	C8684	68 mm	MLS/C.O.T. .027"	\$87.73					C8683	\$29.24
YZF-R6	03-05	C8684-018	68 mm	MLS/C.O.T. .018"	\$100.22					C8683	\$29.24
YZF-R6	03-05	C8699	70 mm	MLS/C.O.T. .027"	\$87.73					C8683	\$29.24
YZF-R6	03-05	C8699-018	70 mm	MLS/C.O.T. .018"	\$100.22					C8683	\$29.24
YZF-R6	06-18	C8710	68 mm	MLS/C.O.T. .027"	\$87.73					C8720	\$29.24
YZF-R6	06-18	C8710-018	68 mm	MLS/C.O.T. .018"	\$100.22					C8720	\$29.24
YZF-R6	06-18	C8712	70 mm	MLS/C.O.T. .027"	\$87.73					C8720	\$29.24
YZF-R6	06-18	C8712-018	70 mm	MLS/C.O.T. .018"	\$100.22					C8720	\$29.24
TX,XS650	74-82	C8810	75mm	MLS/C.O.T. .045"	\$57.20	B0377031F	3.390"	.031" Fiber	\$13.29	C8820	\$37.99
TX,XS650	74-82	C8811	77mm	MLS/C.O.T. .045"	\$57.20	B0377031F	3.390"	.031" Fiber	\$13.29	C8820	\$37.99
TX,XS650	74-82	C8812	79mm	MLS/C.O.T. .045"	\$57.20	B0377031F	3.390"	.031" Fiber	\$13.29	C8820	\$37.99
TX,XS650	74-82	C8813	81mm	MLS/C.O.T. .045"	\$57.20	B0377031F	3.390"	.031" Fiber	\$13.29	C8820	\$37.99







# STREET·ROAD RACE·STRIP



Cometic Gasket - An Exclusive NASCAR Performance® Product

Valve Cover Part#	Price	Magneto Cover Part#	Price	Clutch Cover Part#	Price	Exhaust Gasket Part#	Price	Shift Shaft Part#	Price	Output Shaft Part#	Price
EC374060AFM	\$11.36	EC370060AFM	\$15.85	C8745	\$27.30	OS305	\$5.77	OS416	\$27.99		
EC374060AFM	\$11.36	EC370060AFM	\$15.85	C8745	\$27.30	OS305	\$5.77	OS416	\$27.99		
EC374060AFM	\$11.36	EC370060AFM	\$15.85	C8745	\$27.30	OS305	\$5.77	OS416	\$27.99		
EC374060AFM	\$11.36	EC370060AFM	\$15.85	C8745	\$27.30	OS305	\$5.77	OS416	\$27.99		

Valve Cover Part#	Price	Magneto Cover Part#	Price	Clutch Cover Part#	Price	Exhaust Gasket Part#	Price	Shift Shaft Part#	Price	Output Shaft Part#	Price
				EC890060AFM	\$27.26			OS236	\$4.23	OS424	\$7.99
				EC890060AFM	\$27.26			OS236	\$4.23	OS424	\$7.99
				EC890060AFM	\$27.26			OS236	\$4.23	OS424	\$7.99
				EC890060AFM	\$27.26			OS236	\$4.23	OS424	\$7.99
				EC890060AFM	\$27.26			OS236	\$4.23	OS424	\$7.99
				EC890060AFM	\$27.26			OS236	\$4.23	OS424	\$7.99
				EC890060AFM	\$27.26			OS236	\$4.23	OS424	\$7.99
				EC890060AFM	\$27.26			OS236	\$4.23	OS424	\$7.99
				EC890060AFM	\$27.26			OS236	\$4.23	OS424	\$7.99
				EC890060AFM	\$27.26			OS236	\$4.23	OS424	\$7.99
				EC890060AFM	\$27.26			OS236	\$4.23	OS424	\$7.99
				EC890060AFM	\$27.26			OS236	\$4.23	OS424	\$7.99
				EC890060AFM	\$27.26			OS236	\$4.23	OS424	\$7.99
				EC890060AFM	\$27.26			OS236	\$4.23	OS424	\$7.99
				EC890060AFM	\$27.26			OS236	\$4.23	OS424	\$7.99

Valve Cover Part#	Price	Magneto Cover Part#	Price	Clutch Cover Part#	Price	Exhaust Gasket Part#	Price	Shift Shaft Part#	Price	Output Shaft Part#	Price
								OS227	2.67	OS431	5.99
								OS227	2.67	OS431	5.99
								OS227	2.67	OS268	8.34
						C8870	\$10.10	OS227	2.67	OS268	8.34
						C8876	\$22.00	OS227	2.67	OS268	8.34
EC087020F	\$5.17	EC086020F	\$4.94	C8876	\$22.00	OS227	2.67	OS268	8.34		
EC087020F	\$5.17	EC086020F	\$4.94	C8876	\$22.00	OS227	2.67	OS175	12.99		
EC087020F	\$5.17	EC086020F	\$4.94	C8876	\$22.00	OS227	2.67	OS175	12.99		
EC421020F	\$5.51	EC356032AFM	\$5.28	C8876	\$22.00	OS227	2.67	OS425	8.99		
EC421020F	\$5.51	EC356032AFM	\$5.28	C8876	\$22.00	OS227	2.67	OS425	8.99		
EC938032AFM	\$4.72	EC939032AFM	\$10.68	C8876	\$22.00	OS227	2.67	OS425	8.99		
EC938032AFM	\$4.72	EC939032AFM	\$10.68	C8876	\$22.00	OS227	2.67	OS425	8.99		
EC938032AFM	\$4.72	EC939032AFM	\$10.68	C8876	\$22.00	OS227	2.67	OS425	8.99		
EC938032AFM	\$4.72	EC939032AFM	\$10.68	C8876	\$22.00	OS227	2.67	OS425	8.99		
EC1104018AFM	\$12.99	EC1151032AFM	\$16.64	C8873	35.95	OS227	2.67	OS425	8.99		
EC1104018AFM	\$12.99	EC1151032AFM	\$16.64	C8873	35.95	OS227	2.67	OS425	8.99		
EC1104018AFM	\$12.99	EC1151032AFM	\$16.64	C8873	35.95	OS227	2.67	OS425	8.99		
EC1104018AFM	\$12.99	EC1151032AFM	\$16.64	C8873	35.95	OS227	2.67	OS425	8.99		
EC1646032AFM	\$25.43	EC1647032AFM	\$16.13	C8880	\$17.99	OS197	2.46	OS426	7.99		
EC1646032AFM	\$25.43	EC1647032AFM	\$16.13	C8880	\$17.99	OS197	2.46	OS426	7.99		
EC1646032AFM	\$25.43	EC1647032AFM	\$16.13	C8880	\$17.99	OS197	2.46	OS426	7.99		
EC1646032AFM	\$25.43	EC1647032AFM	\$16.13	C8880	\$17.99	OS197	2.46	OS426	7.99		

**WARNING:** Cancer and Reproductive Harm [www.P65Warnings.ca.gov](http://www.P65Warnings.ca.gov)





# STREET-ROAD RACE-STRIP



Cometic Gasket - An Exclusive NASCAR Performance® Product

## YAMAHA

Model	Year	Head Gasket Part#	Bore	Material/Thickness	Price	Base Gasket Part#	Bore	Material/Thickness	Price	Case Kit Part#	Price
TX, XS650	74-82	C8814	82mm	MLS/C.O.T. .045"	\$57.20	B0377031F3.390"		.031" Fiber	\$13.29	C8820	\$37.99
TX, XS650	74-82	C8043	80.50 mm	CFM-20 .043"	\$54.34	B0377031F3.390"		.031" Fiber	\$13.29	C8820	\$37.99
FZ-07	15-17	C8890	81mm	MLS/C.O.T. .023"	\$37.68					C8892	\$32.08
FZ-07	15-17	C8891	83mm	MLS/C.O.T. .023"	\$37.68					C8892	\$32.08
MT-07	18-19	C8890	81mm	MLS/C.O.T. .023"	\$37.68					C8892	\$32.08
MT-07	18-19	C8891	83mm	MLS/C.O.T. .023"	\$37.68					C8892	\$32.08
FZ-09	14-19	C8918	78mm	MLS/C.O.T. .023"	\$62.63						
FZ-09	14-19	C8919	80mm	MLS/C.O.T. .023"	\$62.63						
FJ-09	15-19	C8918	78mm	MLS/C.O.T. .023"	\$62.63						
FJ-09	15-19	C8919	80mm	MLS/C.O.T. .023"	\$62.63						
Tracer 900	19	C8918	78mm	MLS/C.O.T. .023"	\$62.63						
Tracer 900	19	C8919	80mm	MLS/C.O.T. .023"	\$62.63						
MT-09	18-19	C8918	78mm	MLS/C.O.T. .023"	\$62.63						
MT-09	18-19	C8919	80mm	MLS/C.O.T. .023"	\$62.63						
XSR900	17-19	C8918	78mm	MLS/C.O.T. .023"	\$62.63						
XSR900	17-19	C8919	80mm	MLS/C.O.T. .023"	\$62.63						
XS750	89-19	C8283	77 mm	MLS/C.O.T. .030"	\$87.73	C8382	3.260"	.010" RC	\$30.72	C8088	\$17.26
FZR1000	89-19	C8384	76.5 mm	MLS/C.O.T. .030"	\$83.52	C8382	3.260"	.010" RC	\$30.72	C8088	\$17.26
FZR1000	89-19	C8388	78 mm	MLS/C.O.T. .030"	\$87.73	C8382	3.260"	.010" RC	\$30.72	C8088	\$17.26
YFZ1000R	97-19	C8384	76.5	MLS/C.O.T. .030"	\$83.52	C8382	3.260"	.010" RC	\$30.72		
YFZ1000R	97-19	C8283	77 mm	MLS/C.O.T. .030"	\$87.73	C8382	3.260"	.010" RC	\$30.72		
YFZ1000R	97-19	C8388	78 mm	MLS/C.O.T. .030"	\$87.73	C8382	3.260"	.010" RC	\$30.72		
YZF-R1	98-19	C8562	75 mm	MLS/C.O.T. .027"	\$83.52					C8588	\$29.19
YZF-R1	98-19	C8563	77 mm	MLS/C.O.T. .027"	\$87.73					C8588	\$29.19
YZF-R1	04-19	C8686	78mm	MLS/C.O.T. .018"	\$83.52	C8687		.010" RC	\$30.72	C8688	\$26.74
YZF-R1	04-19	C8695	79mm	MLS/C.O.T. .018"	\$83.52	C8687		.010" RC	\$30.72	C8688	\$26.74
YZF-R1	07-19	C8266	78mm	MLS/C.O.T. .018"	\$83.52	C8687		.010" RC	\$30.72	C8688	\$26.74
YZF-R1	07-19	C8767	79mm	MLS/C.O.T. .018"	\$83.52	C8687		.010" RC	\$30.72	C8688	\$26.74
YZF-R1	09-19	C8794	79mm	MLS/C.O.T. .018"	\$83.52	C8796		.010" RC	\$24.22		
YZF-R1	15-19	C8894	79mm	MLS/C.O.T. .027"	\$83.52	C8895		.010" RC	\$23.29	C8896	\$28.05
FJ1100, 1200	84-96	C8327	77 mm	MLS/C.O.T. .030"	\$83.52	C8139	3.285"	.005" Copper	\$33.68	C8146	\$20.90
FJ1100, 1200	84-96	C8327	77 mm	MLS/C.O.T. .030"	\$83.52	C8140	3.285"	.010" Copper	\$35.38	C8146	\$20.90
FJ1100, 1200	84-96	C8327	77 mm	MLS/C.O.T. .030"	\$83.52	C8597	3.285"	.010" RC	\$29.24	C8146	\$20.90
FJ1100, 1200	84-96	C8327	77 mm	MLS/C.O.T. .030"	\$83.52	C8141	3.285"	.020" Copper	\$35.38	C8146	\$20.90
FJ1100, 1200	84-96	C8327	77 mm	MLS/C.O.T. .030"	\$83.52	C8142	3.285"	.020" Fiber	\$13.97	C8146	\$20.90
FJ1100, 1200 Legend Approved	84-96	C8285	77.5mm	MLS/C.O.T. .030"	\$83.52	C8139	3.285"	.005" Copper	\$33.68	C8146	\$20.90
FJ1100, 1200 Legend Approved	84-96	C8285	77.5mm	MLS/C.O.T. .030"	\$83.52	C8140	3.285"	.010" Copper	\$35.38	C8146	\$20.90
FJ1100, 1200 Legend Approved	84-96	C8285	77.5mm	MLS/C.O.T. .030"	\$83.52	C8597	3.285"	.010" RC	\$29.24	C8146	\$20.90
FJ1100, 1200 Legend Approved	84-96	C8285	77.5mm	MLS/C.O.T. .030"	\$83.52	C8141	3.285"	.020" Copper	\$35.38	C8146	\$20.90
FJ1100, 1200 Legend Approved	84-96	C8285	77.5mm	MLS/C.O.T. .030"	\$83.52	C8142	3.285"	.020" Fiber	\$13.97	C8146	\$20.90
FJ1100, 1200	84-96	C8351	78 mm	MLS/C.O.T. .030"	\$87.73	C8139	3.285"	.005" Copper	\$33.68	C8146	\$20.90
FJ1100, 1200	84-96	C8351	78 mm	MLS/C.O.T. .030"	\$87.73	C8140	3.285"	.010" Copper	\$35.38	C8146	\$20.90
FJ1100, 1200	84-96	C8351	78 mm	MLS/C.O.T. .030"	\$87.73	C8597	3.285"	.010" RC	\$29.24	C8146	\$20.90
FJ1100, 1200	84-96	C8351	78 mm	MLS/C.O.T. .030"	\$87.73	C8141	3.285"	.020" Copper	\$35.38	C8146	\$20.90
FJ1100, 1200	84-96	C8351	78 mm	MLS/C.O.T. .030"	\$87.73	C8142	3.285"	.020" Fiber	\$13.97	C8146	\$20.90
FJ1100, 1200	84-96	C8330	79 mm	MLS/C.O.T. .030"	\$83.52	C8139	3.285"	.005" Copper	\$33.68	C8146	\$20.90
FJ1100, 1200	84-96	C8330	79 mm	MLS/C.O.T. .030"	\$83.52	C8140	3.285"	.010" Copper	\$35.38	C8146	\$20.90
FJ1100, 1200	84-96	C8330	79 mm	MLS/C.O.T. .030"	\$83.52	C8597	3.285"	.010" RC	\$29.24	C8146	\$20.90
FJ1100, 1200	84-96	C8330	79 mm	MLS/C.O.T. .030"	\$83.52	C8141	3.285"	.020" Copper	\$35.38	C8146	\$20.90
FJ1100, 1200	84-96	C8330	79 mm	MLS/C.O.T. .030"	\$83.52	C8142	3.285"	.020" Fiber	\$13.97	C8146	\$20.90
FJ1100, 1200 Legend Approved	84-96	C8174	79mm	.032" Copper	\$65.64	C8139	3.285"	.005" Copper	\$33.68	C8146	\$20.90
FJ1100, 1200 Legend Approved	84-96	C8174	79mm	.032" Copper	\$65.64	C8140	3.285"	.010" Copper	\$35.38	C8146	\$20.90
FJ1100, 1200 Legend Approved	84-96	C8174	79mm	.032" Copper	\$65.64	C8597	3.285"	.010" RC	\$29.24	C8146	\$20.90
FJ1100, 1200 Legend Approved	84-96	C8174	79mm	.032" Copper	\$65.64	C8141	3.285"	.020" Copper	\$35.38	C8146	\$20.90
FJ1100, 1200 Legend Approved	84-96	C8174	79mm	.032" Copper	\$65.64	C8142	3.285"	.020" Fiber	\$13.97	C8146	\$20.90
FJ1100, 1200	84-96	C8328	81 mm	MLS/C.O.T. .030"	\$87.73	C8239	3.460"	.020" Fiber	\$13.97	C8146	\$20.90
FJ1100, 1200	84-96	C8328	81 mm	MLS/C.O.T. .030"	\$87.73	C8240	3.460"	.005" Copper	\$33.68	C8146	\$20.90
FJ1100, 1200	84-96	C8328	81 mm	MLS/C.O.T. .030"	\$87.73	C8241	3.460"	.010" Copper	\$35.38	C8146	\$20.90
FJ1100, 1200	84-96	C8328	81 mm	MLS/C.O.T. .030"	\$87.73	C8242	3.460"	.020" Copper	\$35.38	C8146	\$20.90
FJ1100, 1200	84-96	C8328	81 mm	MLS/C.O.T. .030"	\$87.73	C8598	3.460"	.010" RC	\$30.72	C8146	\$20.90
FJ1100, 1200	84-96	C8329	83 mm	MLS/C.O.T. .030"	\$87.73	C8239	3.460"	.020" Fiber	\$13.97	C8146	\$20.90
FJ1100, 1200	84-96	C8329	83 mm	MLS/C.O.T. .030"	\$87.73	C8240	3.460"	.005" Copper	\$33.68	C8146	\$20.90
FJ1100, 1200	84-96	C8329	83 mm	MLS/C.O.T. .030"	\$87.73	C8241	3.460"	.010" Copper	\$35.38	C8146	\$20.90
FJ1100, 1200	84-96	C8329	83 mm	MLS/C.O.T. .030"	\$87.73	C8242	3.460"	.020" Copper	\$35.38	C8146	\$20.90
FJ1100, 1200	84-96	C8329	83 mm	MLS/C.O.T. .030"	\$87.73	C8598	3.460"	.010" RC	\$30.72	C8146	\$20.90







# STREET-ROAD RACE-STRIP



Cometic Gasket - An Exclusive NASCAR Performance® Product

## YAMAHA

Model	Year	Head Gasket Part#	Bore	Material/Thickness	Price	Base Gasket Part#	Bore	Material/Thickness	Price	Case Kit Part#	Price
XS1100	78-81	C8046	76 mm	CFM-20 .043"	\$54.34						
VMX12 V-Max / XVZ13 Royal Star	83-07	C8535	85mm	MLS/C.O.T. .030"	\$87.73						
VMX12 V-Max / XVZ13 Royal Star	83-07	C8536	80mm	MLS/C.O.T. .030"	\$87.73						
XV1600 Road Star /Midnight Star	99-03	C8673	95 mm	MLS/C.O.T. .030"	\$59.52						
XV1600 Road Star/ Midnight Star	99-03	C8674	97 mm	MLS/C.O.T. .030"	\$59.52						
XV1600 Road Star/ Midnight Star	99-03	C8675	100 mm	MLS/C.O.T. .030"	\$59.52						
XV1600 Road Star/ Midnight Star	99-03	C8676	102 mm	MLS/C.O.T. .030"	\$59.52						
XV1700 Road Star	04-14	C8678	100 mm	MLS/C.O.T. .030"	\$59.52						
XV1700 Road Star	04-14	C8679	102 mm	MLS/C.O.T. .030"	\$59.52						
XV1700 Road Star Warrior	04-09	C8677	97 mm	MLS/C.O.T. .030"	\$59.52						
XV1900 Raider, Roadliner, Stratoliner	06-14	C8857	102 mm	MLS/C.O.T. .030"	\$43.54						
XV1900 Raider, Roadliner, Stratoliner	06-14	C8858	103 mm	MLS/C.O.T. .030"	\$43.54						



## Personal Watercraft

Model	Displ. cc	Bore mm	Top End Kit Part #	Price
<b>ARCTCO</b> Barracuda, Daytona 94-95, Montego, Montego Deluxe 94-97, TT640R 98-99, TS640L 98, Tigershark, Tigershark Daytona 93	639	77mm	C6052	\$44.97
Monte Carlo, Daytona 96-97, TS770, TS-L770, TS-R 98-99	770	84mm	C6144	\$60.81
Tigershark 900 95, Monte Carlo 900 96, Daytona 1000 97	900	O-Ring	C6116	\$72.97
TS-11000, TS-R1000 98	999	O-Ring	C6162	\$72.97
<b>KAWASAKI</b> JS300, JS300SX 86-94	300	78mm	C6001	\$21.86
JS440, JSX440, JSX440SX 82-92	440	70mm	C6002	\$39.99
JS440, JSX440, JSX440SX 82-92	475	73mm	C6003	\$39.99
JS550 thru 82-88	550	77mm	C6004	\$59.57
JS550, JSX550 89-95	550	78mm	C6015	\$59.57
JS650SC 91-95, JF650X2 86-95, JF650TS 89-96	650	78mm	C6005	\$42.54
JS650SX 87-93, JS650SC 91-95, JF650X2 86-95	701	80mm	C6078	\$42.54
JS750SX 92-95, JS750Sxi 95-97, JH750Xi 93-97, JH750SS 92-97, JH750XiR 94	750	83mm	C6043	\$42.54
JT750STS 95-97, JT750ST 94-95, 750ZXi 95-97, 750SXi 98-02				
750Xi 95-97, SXI Pro 98-02, STX 98	766	81mm	C6215	\$42.54
750ZXi 95-97, SXI Pro 98-02, STX 98, SX800R 03-06	779	83mm	C6126	\$42.54
750ZXi 95-97, SXI Pro 98-02, STX 98, SX800R 03-06	830	84.5mm	C6158	\$42.54
800 SXR 03-11	779	82mm	C6214	\$58.99
900ZXi 95-97, STX 97-06	941	75mm	C6118	\$60.81
1100ZXi 96-03, 1100STX 97-99, STX D. I. 00-03	1097	81mm	C6145	\$72.97
1100Zxi 96-03, 1100STX 97-99, STX D. I. 00-03	1195	84.5mm	C6159	\$85.12
Ultra 150 99-05, 1200STX '02-05	1205	81mm	C6202	\$85.12
Ultra 250/260X 07-10 (Head Gasket Only)	1498	84mm	C6222	\$103.17
<b>POLARIS</b> SL650 92-95, SL650STD 92-95	650	67mm	C6044	\$60.81
SLTH 96-03, SLT 700 96-03, SL700DLX 96-03, SLH 96-03, SL700 96-03	700	O-Ring	C6146	\$72.97
SL750 92-96, SLT 92-96	750	71.25mm	C6055	\$72.97
SL750 92-96, SLT 92-96	782	72mm	C6089	\$72.97
SLX780 95-97, SL780 95-96, SLT780 95-96	780	71.5mm	C6143	\$60.81
SLX 785 Pro 97-01	785	72mm	C6181	\$60.81
SL900 96-97	900	O-Ring	C6147	\$60.81
SLTX1050 97-04, SL1050 96-04, SLXH 98-04	1051	O-Ring	C6148	\$60.81
Genesis Ffi 00-04, Pro 1200 00-04, SLX, Virage TX 00-04	1176	86mm	C6212	\$97.27

All Component Parts can be purchased individually.



**WARNING:** Cancer and Reproductive Harm www.P65Warnings.ca.gov



# STREET·ROAD RACE·STRIP



Cometic Gasket - An Exclusive NASCAR Performance® Product

Valve Cover Part#	Price	Magneto Cover Part#	Price	Clutch Cover Part#	Price	Exhaust Gasket Part#	Price	Shift Shaft Part#	Price	Output Shaft Part#	Price
						C8882	\$29.98	OS227	2.67	N/A	N/A
						C8880	\$17.99	OS227	2.67	N/A	N/A
						C8880	\$17.99	OS227	2.67	N/A	N/A
								OS286	4.29	OS429	17.99
								OS286	4.29	OS429	17.99
								OS286	4.29	OS429	17.99
								OS286	4.29	OS429	17.99
								OS286	4.29	OS429	17.99
								OS286	4.29	OS429	17.99
								OS286	4.29	OS430	15.99
								OS286	4.29	OS430	15.99



# Personal Watercraft

Model	Displ. cc	Bore mm	Top End Kit Part #	Price
<b>SEA DOO</b>				
580 Yellow Motor 91, 580XP 91, 580GT 90-91	580	O-Ring	C6010	\$60.81
580 White Motor, 580 SP, XP, SPX, SPi, GTS, GTX 92-96	580	O-Ring	C6095	\$60.81
650XP 93-94, 650XPI 94-95, 650SPX 94-95, GTX650 94-95	657	O-Ring	C6056	\$60.81
GTI750, SPX750, XP750, HX750, GS750, GTS 750 97-01	717	O-Ring	C6119	\$60.81
XP 800, GSX800, GTX800, SPX800, XP800 Ready, RFI800, 97-01 (Lay Down Motor)	787	O-Ring	C6154	\$60.81
GSX950 Limited 97-99, GTX950 Limited 98-00	993	90mm	C6157	\$97.27
XP950 Limited 98-00, GTX950 00, RX950 00, LRV950 00				
GSX950 Limited 97-99, GTX950 Limited 98-00	1017	90mm	C6203	\$97.27
XP950 Limited 98-00, GTX950 00, RX950 00, LRV950 00				
4TEC 02-14 (Head Gasket Only)	1494	101mm	C6223	\$103.17
<b>SUZUKI</b>				
Wet Bike 78-92		86mm	C6163	\$39.99
<b>YAMAHA</b>				
Waverunner III 90-93, VXR 91-95, Waverunner 90-93, Super Jet ALL, LX633 90-96	633	79mm	C6012	\$43.77
Waveblaster 93-95, Super Jet 94-95, Waverunner III 94-97, Pro-VXR 93-94, FX700 94-95, Waveraider 700 96-99 (Kit works with all single carb models)	701	83mm	C6057	\$43.77
Waveblaster 96-97, Super Jet 97-00, Wave Venture 700 95-97, Waveraider 700 93-95, Waveraider Deluxe 93-95, XL700 thru 99-00 (Kit works with all dual carb models)	701	83mm	C6084	\$47.41
Waveblaster 96-97, Super Jet 97-00, Wave Venture 700 95-97, Waveraider 700 93-95, Waveraider Deluxe 93-95, XL700 thru 99-00 (Kit works with all dual carb models)	760	85mm	C6086	\$47.41
Waveraider 760 96-99, Waveblaster II 96-99, Wave Venture 760 97, Waverunner 96-97, Waverunner GP 760 '00	754	85mm	C6149	\$47.41
Waveraider 760 96-99, Waveblaster II 96-99, Wave Venture 760 97, Waverunner 96-97	789	86mm	C6155	\$47.41
800 GP 98-00	800	86mm	C6199	\$47.41
Waveraider 1100 95-97, Wave Venture 1100 96-97	1051	83mm	C6121	\$97.27
1200 GP 97-99, SUV1200 00, XI 1200 00	1131	86mm	C6160	\$97.27
GP1200R 01-10 (with power valve)	1176	82mm	C6220	\$142.52
FZR Waverunner 08-14 (Head Gasket Only)	1812	86mm	C6221	\$103.17

All Component Parts can be purchased individually.

**WARNING:** Cancer and Reproductive Harm www.P65Warnings.ca.gov



**AFM® Series Gaskets • Aluminum Foamet Composite Material**

Cometic Part #-C9888 Complete Primary Kit FLT, FLHT, FXR 94-06

Cometic Part #-C9889 Complete Primary Kit FLT, FLHT, FXR 80-93

**Cometic Part #-C9261**  
 Starter Shaft Seal 94-06  
 Dyna 94-05  
 All B/T Models  
 Replaces: 12066  
**Cometic Part #-C9379**  
 Starter Shaft Seal 89-93  
 All B/T Models  
 Replaces: 12053

**Cometic Part #-C9441**  
 Inner Primary to Motor  
 Case O-Ring  
 Dyna L82-05  
 All Models L82-06  
 Replaces: 11147

**Cometic Part #-C9536**  
 Inner Primary to Motor  
 Case O-Ring  
 All Models 70-E82  
 Replaces: 11125

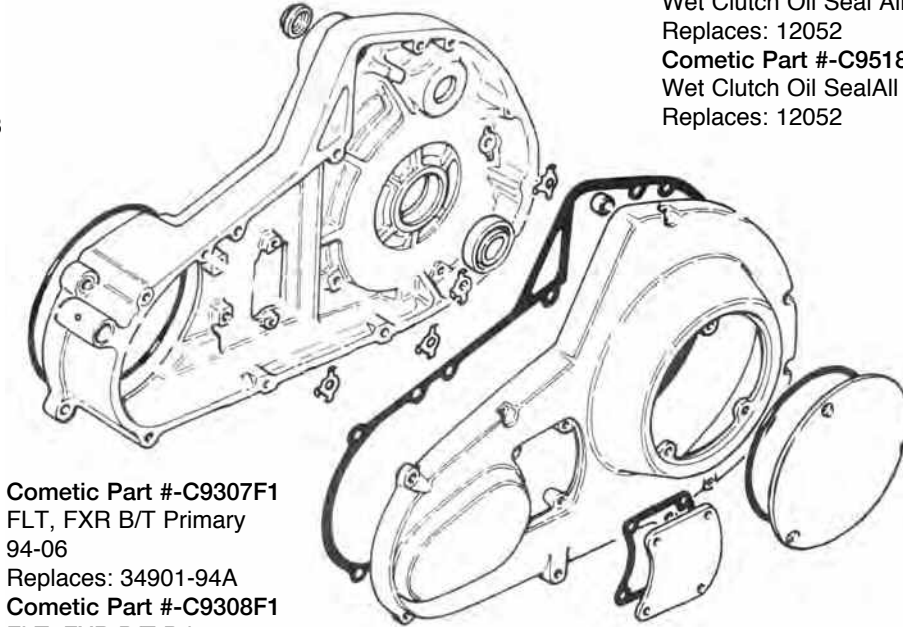

**Cometic Part #-C9307F1**  
 FLT, FXR B/T Primary  
 94-06  
 Replaces: 34901-94A  
**Cometic Part #-C9308F1**  
 FLT, FXR B/T Primary  
 80-93  
 Replaces: 34901-79A

**Cometic Part #-C9305F1**  
 FLT, FXR Inspection Cover 85-06  
 Replaces: 34906-85A

**Cometic Part #-C9303F1**  
 FLT, FXR Inspection Cover 80-84  
 Replaces: 34906-79A

**Cometic Part #-C9261**  
 Starter Shaft Seal  
 Dyna 94-05, All B/T  
 Models 94-06 Replaces: 12066

**Cometic Part #-C9379**  
 Starter Shaft Seal 89-93 All B/T Models  
 Replaces: 12053

**Cometic Part #-C9260**  
 Wet Clutch Oil Seal All Models L84-UP  
 Replaces: 12052

**Cometic Part #-C9518**  
 Wet Clutch Oil Seal All Models 70-E84  
 Replaces: 12052

**Cometic Part #-C9441**  
 Inner Primary to  
 Motor Case O-Ring  
 All Models L82-06,  
 Dyna L82-05  
 Replaces: 11147

**Cometic Part #-C9536**  
 Inner Primary to  
 Motor Case O-Ring All  
 Models 70-E82  
 Replaces: 11125

**Cometic Part #-C9942F1**  
 Primary Spacer Gasket "Pair"  
 Softail 95-06

**Cometic Part #-C9331F1** Inspection Cover Gasket  
 Dyna & Softail, 4 & 5 Speed Dyna 65-05 , Softail 65-06

**Cometic Part #-C9260**  
 Wet Clutch Oil Seal All Models L84-17  
 Replaces: 12052

**Cometic Part #-C9518**  
 Wet Clutch Oil Seal All Models 70-E84  
 Replaces: 12052

**Cometic Part #-C9662**  
 Derby Cover O-Ring  
 All Big Twin Models  
 99-06, Dyna 99-05  
 Replaces: 25416-99

**Cometic Part #-C9442**  
 Derby Cover O-Ring  
 All Big Twin Models  
 L84-98  
 Replaces: 25416-84

**Cometic Part #-C9997F1**  
 Derby Cover Gasket  
 Replaces O-Ring  
 All Big Twin Models  
 99-15 5 Hole  
 Replaces: 25416-99C

**Cometic Part #-C9309F1**  
 Primary Gasket Softail 89-06, Dyna 89-05  
 Replaces: 60539-89

**Cometic Part #-C9607F1**  
 Primary Gasket Softail, Superglide 65-88  
 All Four Speeds  
 Replaces: 60538-81C

**Cometic Part #-C9885**  
 94-06 FXST, 94-05 FXD Primary Kit

**Cometic Part #-C9886**  
 89-93 FXST, FXD Primary Kit

**Cometic Part #-C9887**  
 65-88 FXST, FX, FL 4-Speed Primary Kit

**Cometic Part #-C9338F1**  
 Derby Cover Gasket  
 All 4 Speed Models 70-83  
 Replaces: 25416-70

**Cometic Part #-C9662**  
 Derby Cover O-Ring  
 All Big Twin Models  
 99-06, Dyna 99-05  
 Replaces: 25416-99

**Cometic Part #-C9442**  
 Derby Cover O-Ring  
 All Big Twin Models  
 L84-98  
 Replaces: 25416-84

**Cometic Part #-C9997F1**  
 Derby Cover Gasket  
 Replaces O-Ring  
 All Big Twin Models  
 99-15 5 Hole

Replaces: 25416-99C

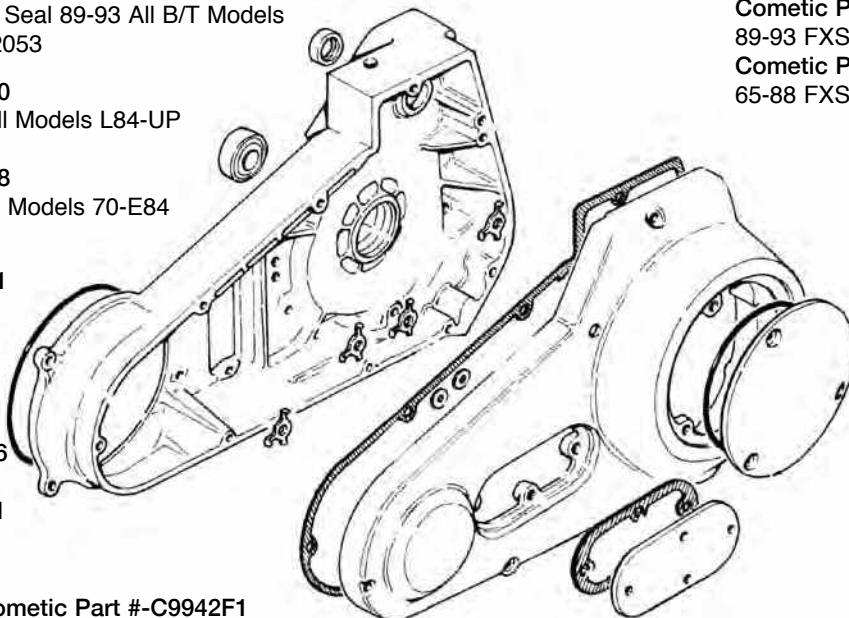





# Gaskets for Harley-Davidson®



Cometic Gasket - An Exclusive NASCAR Performance® Product

## Big Twin Primary Gasket & Seal Kits (All kits contain all Gaskets and Seals needed to R&R Inner & Outer Primary)

Cometic Part #	Description	Price
C10196	2017-19, ALL M8 FL MODELS	\$66.95
C10248	2018-19, ALL M8 FXST MODELS	\$66.95
C9173	07-16 FL Models Primary Kit	\$93.72
C9150	06-14 Dyna Primary Kit, 07-17 Softail	\$93.72
C9885	94-06 FXST, 94-05 FXD Primary Kit	\$105.17
C9888	94-06 FLT, FLHT, FXR Primary Kit	\$99.90
C9886	89-93 FXST, FXD Primary Kit	\$105.69
C9889	80-93 FLT, FLHT, FXR Primary Kit	\$76.51
C9887	65-88 FXST, FX, FL 4-Speed Primary Kit	\$76.51

## Primary Gaskets Big Twin, Twin Cam

Cometic Part #	OE#	Description	Single Price	5 Pack Price
C10198F1	25700378	2017-19 ALL M8 FL MODELS, PRIMARY GASKET	\$34.74	\$156.28
C10241F1	25700564	2018-19 ALL M8 FXST MODELS PRIMARY GASKET	\$34.74	156.28
C9179F1	34901-07	07-16 FL Models Primary	\$34.74	\$156.28
C9145F1	60547-06	06-14 Dyna, 07-17 Softail	\$34.74	\$156.28
C9199F1	34934-06	06-17 Dyna, 06-17 ALL FXST, 07-16 ALL FL, Inner Primary Spacer/Seal	\$27.49	\$137.44
C9942F1	63859-95A	95-06 Softail primary spacer gasket (Pair)	\$2.29	\$10.06
C9307F1	34901-94A	94-06 FLT, FXR Big Twin Primary	\$34.74	\$156.28
C9308F1	34901-79A	80-93 Big Twin Primary FLT/FXR	\$34.74	\$156.28
C9309F1	60539-89	89-06 Softail, 89-05 Dyna	\$34.74	\$156.28
C9607F1	60538-81C	65-88 FXST, FX / FL 4 -SPEED	\$34.74	\$156.28

## Inspection Cover Gaskets Big Twin , Twin Cam

Cometic Part #	OE#	Description	Single Price	5 Pack Price
C9305F1	34906-85A	85-06 FXR, FLT Insp. Cover	\$8.30	\$33.16
C9303F1	34906-79A	80-84 FXR,FLT Insp. Cover	\$7.79	\$33.16
C9326F1	60567-36	36-58-64-69 FL, XLCH Inspection Cover	\$4.09	\$21.17
C9331F1	60567-65B	65-06 Softail 4&5 Speed, 89-05 Dyna Inspection Cover	\$5.44	\$23.87

## Derby Cover Gasket Big Twin

Cometic Part #	OE#	Description	Single Price	5 Pack Price
C10140F1	25416-16	2016 FL SLIM, 2017-19 ALL FL, 2018-19 ALL FXST, Derby Cover Gasket	\$6.32	\$27.60
C9997F1	25416-99C	99-16 FL MODELS, 99-17 FXD & FXST Derby Cover Repl. O-ring, 5 Hole	\$6.32	\$27.60
C9997F1-SD	25416-99C	99-16 FL MODELS, 99-17 FXD & FXST Derby Cover Repl. "Solid", 5 Hole	\$6.32	\$27.60
C9183F1	C9183F5	84-98 All Derby Cover Replaces O-Ring , 3 Hole	\$6.32	\$27.60
C9152F1	C9152F5	06-14 Dyna, 07-14 All Twin Cam Models O-ring	\$6.32	\$27.60
C9338F1	C9338F5	70-83 FL, FXR Derby Cover	\$7.79	\$39.08

## Cam Cover Gaskets Big Twin , Twin Cam

Cometic Part #	OE#	Description	Single Price	5 Pack Price
C10173F1	C10173F5	17-19 ALL M8 FL MODELS, 2018-19 ALL M8 FXST MODELS Cam Cover	\$7.16	\$32.19
C9575F1	C9575F5	25244-99 99-16 FL MODELS, 2000-17 FXD & FXST Twin Cam, Cam Cover	\$11.29	\$56.21
C9328F1	C9328F5	25225-93X 93-98 Big Twin Cam Cover	\$6.96	\$34.51
C9302F1	C9302F5	25225-70X 70-92 Big Twin Cam Cover	\$6.96	\$34.51
C9334F1	C9334F5	25225-36C 41-69 Big Twin Cam Cover	\$14.27	\$57.09

## Sportster Primary Gasket and Seal Kit

Cometic Part #	Description	Price
C9125	04-19 Sportster Complete Primary Rebuild	\$30.38
C9211	91-03 Sportster Complete Primary Rebuild	\$40.88
C9210	96-90 Sportster Complete Primary Rebuild	\$40.88

## Sportster Primary Gasket

Cometic Part #	OE#	Description	Single Price	5 Pack Price
C9943F1	C9943F5	34955-04 04-19 Sportster Primary	\$24.09	\$108.31
C9314F1	C9314F5	34955-89A 91-03 Sporty Primary	\$24.09	\$108.31
C9310F1	C9310F5	34955-75X 77-90 Sporty Primary	\$24.09	\$108.31

## Sportster Cam Cover Gasket

Cometic Part #	OE#	Description	Single Price	5 Pack Price
C9944F1	C9944F5	25263-90D 04-19 Sportster Cam Cover	\$7.79	\$33.16
C9313F1	C9313F5	25263-90B 91-03 Sporty Cam Cover	\$12.52	\$62.47
C9311F1	C9311F5	25263-86 86-90 Sporty Cam Cover	\$13.93	\$69.42
C10029F1	C10029F5	25279-08 08-UP XR1200 Cam Cover	\$7.79	\$33.16

## Street 500-750 Alternator Cover Gasket

Cometic Part #	OE#	Description	Single Price	5 Pack Price
C10131F1	C10131F5	25700224 2014-19 Street 500/750 Alternator Cvr Gasket	\$11.05	\$49.72

## Street 500-750 Primary Cover Gasket

Cometic Part #	OE#	Description	Single Price	5 Pack Price



Gaskets for Harley-Davidson®



Cometic Gasket - An Exclusive NASCAR Performance® Product

MLS® Multi-Layer Steel

Part #	Description	Price
<b>V - Rod MLS Head Gaskets (Pairs) 2001-16</b>		
C9895	V-Rod .027" Std Bore Head Gasket	\$98.08
C9896	V-Rod .030" Std Bore Head Gasket	\$98.08
C9897	V-Rod .027" 4.250" Bore Head Gasket	\$98.08
C9898	V-Rod .030" 4.250" Bore Head Gasket	\$98.08
<b>V - Rod EXTREME DUTY Exhaust Gaskets (Pair) 2001-16</b>		
C9928	V-Rod Extreme Performance Exhaust Gasket	\$10.90
C10060	V-Rod OE Replacement Gasket Pair (Replaces 65109-01)	\$24.50

**Twin Cam, Twin Cooled MLS Head Gaskets (Pairs) Select 2014 -16 Touring Models & Trikes**

**NOTE: TWIN COOLED H/G WILL RETRO TO AIR COOLED HEADS & CYLINDERS**

C10081	3.875", .027"MLS, Twin Cooled 2014-16	\$46.34
C10081-030	3.875", .030"MLS, Twin Cooled 2014-16	\$46.34
C10081-036	3.875", .036"MLS, Twin Cooled 2014-16	\$46.34
C10081-040	3.875", .040"MLS, Twin Cooled 2014-16	\$46.34
C10081-045	3.875", .045"MLS, Twin Cooled 2014-16	\$46.34
C10083	3.937", .027"MLS, Twin Cooled 2014-16	\$46.34
C10083-030	3.937", .030"MLS, Twin Cooled 2014-16	\$46.34
C10083-036	3.937", .036"MLS, Twin Cooled 2014-16	\$46.34
C10083-040	3.937", .040"MLS, Twin Cooled 2014-16	\$46.34
C10083-045	3.937", .045"MLS, Twin Cooled 2014-16	\$46.34
C10084	4.000", .027"MLS, Twin Cooled 2014-16	\$46.34
C10084-030	4.000", .030"MLS, Twin Cooled 2014-16	\$46.34
C10084-036	4.000", .036"MLS, Twin Cooled 2014-16	\$46.34
C10084-040	4.000", .040"MLS, Twin Cooled 2014-16	\$46.34
C10084-045	4.000", .045"MLS, Twin Cooled 2014-16	\$46.34
C10085	4.060", .027"MLS, Twin Cooled 2014-16	\$46.34
C10085-030	4.060", .030"MLS, Twin Cooled 2014-16	\$46.34
C10085-036	4.060", .036"MLS, Twin Cooled 2014-16	\$46.34
C10085-040	4.060", .040"MLS, Twin Cooled 2014-16	\$46.34
C10085-045	4.060", .045"MLS, Twin Cooled 2014-16	\$46.34
C10086	4.125", .027"MLS, Twin Cooled 2014-16	\$46.34
C10086-030	4.125", .030"MLS, Twin Cooled 2014-16	\$46.34
C10086-036	4.125", .036"MLS, Twin Cooled 2014-16	\$46.34
C10086-040	4.125", .040"MLS, Twin Cooled 2014-16	\$46.34
C10086-045	4.125", .045"MLS, Twin Cooled 2014-16	\$46.34
C10087	4.160", .027"MLS, Twin Cooled 2014-16	\$46.34
C10087-030	4.160", .030"MLS, Twin Cooled 2014-16	\$46.34
C10087-036	4.160", .036"MLS, Twin Cooled 2014-16	\$46.34
C10087-040	4.160", .040"MLS, Twin Cooled 2014-16	\$46.34
C10087-045	4.160", .045"MLS, Twin Cooled 2014-16	\$46.34
C10088	4.250", .027"MLS, Twin Cooled 2014-16	\$46.34
C10088-030	4.250", .030"MLS, Twin Cooled 2014-16	\$46.34
C10088-036	4.250", .036"MLS, Twin Cooled 2014-16	\$46.34
C10088-040	4.250", .040"MLS, Twin Cooled 2014-16	\$46.34
C10088-045	4.250", .045"MLS, Twin Cooled 2014-16	\$46.34

**Twin Cam MLS Head Gaskets (Pairs)**

\*2007 Twin Cams 96" displacement increase was made by increasing the stroke to 4.375" std. 96" and big bore 103" are the same bore size as 88" and 95" bores.

C9790	3.750" Head Gasket .030" MLS All Twin Cam Models Std bore 1999-17	\$46.34
C9745	3.750" Head Gasket .040" MLS All Twin Cam Models Std bore 1999-17	\$46.34
C9181	3.750" Head Gasket .045" MLS All Twin Cam Models Std bore 1999-17	\$46.34
C9157	3.750" Head Gasket .051" MLS All Twin Cam Models Std bore 1999-17	\$46.34
C9158	3.750" Head Gasket .060" MLS All Twin Cam Models Std bore 1999-17	\$68.83
C9721	3.875" Head Gasket .030" MLS All Twin Cam Models 95" & 103" 1999-17	\$46.34
C9721-040	3.875" Head Gasket .040" MLS All Twin Cam Models 95" & 103" 1999-17	\$46.34
C9721-045	3.875" Head Gasket .045" MLS All Twin Cam Models 95" & 103" 1999-17	\$46.34
C9721-051	3.875" Head Gasket .051" MLS All Twin Cam Models 95" & 103" 1999-17	\$46.34
C9721-060	3.875" Head Gasket .060" MLS All Twin Cam Models 95" & 103" 1999-17	\$68.83





MLS® Multi-Layer Steel

Part # Description Price

Twin Cam MLS Head Gaskets (Pairs) con't.

\*2007 Twin Cams 96" displacement increase was made by increasing the stroke to 4.375" std. 96 and big bore 103" are the same bore size as 88" and 95" bores.

Table listing various Twin Cam MLS Head Gaskets (Pairs) with part numbers, descriptions, and prices ranging from \$46.34 to \$46.34.

Twin Cam SLS Base Gasket (Pairs) Single Layer Steel 1999-17

Table listing Twin Cam SLS Base Gaskets (Pairs) Single Layer Steel 1999-17 with part numbers, descriptions, and prices ranging from \$24.57 to \$24.57.

S&S Head Gaskets

Table listing S&S Head Gaskets with part numbers, descriptions, and prices ranging from \$46.34 to \$70.91.

S&S Base Gaskets

Table listing S&S Base Gaskets with part numbers, descriptions, and prices ranging from \$24.57 to \$24.57.

Street 500 & 750 Head & Base Gaskets 2014-19

Table listing Street 500 & 750 Head & Base Gaskets 2014-19 with part numbers, descriptions, and prices ranging from \$42.50 to \$56.95.

EVO Big Twin & Sportster MLS Head Gaskets (Pairs)

Table listing EVO Big Twin & Sportster MLS Head Gaskets (Pairs) with part numbers, descriptions, and prices ranging from \$46.33 to \$68.83.



# Gaskets for Harley-Davidson®



Cometic Gasket - An Exclusive NASCAR Performance® Product

## Head & Base Gaskets

Part #	Description	Price
<b>EVO Big Twin &amp; Sportster MLS Head Gaskets (Pairs) con't</b>		
C9690	3 5/8" Big Bore EVO's .030", 1984-99 B/T, 1984-19 XL	\$46.33
C9691	3 5/8" Big Bore EVO's .040" 1984-99 B/T, 1984-19 XL	\$46.33
C9694	3 3/4" Big Bore EVO's .030" 1984-99 B/T, 1984-19 XL	\$46.33
C9695	3 3/4" Big Bore EVO's .040" 1984-99 B/T, 1984-19 XL	\$46.33
C9692	3 13/16" Big Bore EVO's .030" 1984-99 B/T, 1984-19 XL	\$46.33
C9693	3 13/16" Big Bore EVO's .040" 1984-99 B/T, 1984-19 XL	\$46.33
C9877	4.000" Bore S&S and TP cylinders .027" solid dowels	\$46.33
C9878	4.000" Bore S&S and TP cylinders .030" solid dowels	\$46.33
C9879	4.000" Bore S&S and TP cylinders .036" solid dowels	\$46.33
C9880	4.000" Bore S&S and TP cylinders .040" solid dowels	\$46.33
C9881	4.125" Bore TP cylinders .027" solid dowels	\$46.33
C9882	4.125" Bore TP cylinders .030" solid dowels	\$46.33
C9883	4.125" Bore TP cylinders .036" solid dowels	\$46.33
C9884	4.125" Bore TP cylinders .040" solid dowels	\$46.33
C10069	4.250" Bore S&S and TP cylinders head & Base kit .030" head, .020" base	\$56.78
<b>EVO Big Twin SLS Base Gaskets (Pairs) Single Layer Steel</b>		
C9101	1340 Evolution B/T STD bore .010" 1984-99	\$24.57
C9551	1340 Evolution B/T STD bore .020" 1984-99	\$24.57
C9532	3 5/8" & 3 3/4" Big Bore 1340 B/T EVO's .010" 1984-99	\$24.57
C9552	3 5/8" & 3 3/4" Big Bore 1340 B/T EVO's .020" 1984-99	\$24.57
C9869	3 13/16" Evolution B/T .010" 1984-99	\$24.57
C9870	3 13/16" Evolution B/T .020" 1984-99	\$24.57
C9871	4.000" S&S and TP cylinder .010"	\$24.57
C9872	4.000" S&S and TP cylinder .020"	\$24.57
C9873	4.125" TP cylinder .010"	\$24.57
C9874	4.125" TP cylinder .020"	\$24.57
<b>EVO Sportster SLS Base Gaskets (Pairs) Single Layer Steel</b>		
C9100	883/1200 EVO Sportsters .010" 1984-19	\$24.57
C9553	883/1200 EVO Sportsters .020" 1984-19	\$24.57
C9554	3 5/8" Big Bore 883/1200 EVO Sportsters .010" (Also fits Wiseco 3 3/4" Steel Sleeve Big Bore)	\$24.57
C9555	3 5/8" Big Bore 883/1200 EVO Sportsters .020" (Also fits Wiseco 3 3/4" Steel Sleeve Big Bore)	\$24.57
C9875	3 3/4" & 3 13/16" Evo Sporty Millenium Cylinders .010" (Either bore utilizes a 4.00" O.D. Spigot Diameter)	\$24.57
C9876	3 3/4" & 3 13/16" Evo Sporty Millenium Cylinders .020" (Either bore utilizes a 4.00" O.D. Spigot Diameter)	\$24.57
<b>Shovelhead and Panhead MLS Head Gaskets (Pairs)</b>		
C9984	Std Bore Head Gasket .040" MLS Shovelhead 74" & 80" 1966-84	\$46.34
C9985	3 5/8" Head Gasket .040" MLS Shovelhead Big Bore 1966-84	\$46.34
C10037	3 13/16" Head Gasket .040" MLS Shovelhead Big Bore 1966-84	\$46.34
C9137	Head Gasket .040" MLS Panhead Std. Bore 1948-65	\$46.34
C10070	3 5/8" Bore Head Gasket .040" MLS Panhead 1948-65	\$46.34
<b>Shovelhead and Panhead SLS Base Gaskets (Pairs)</b>		
C9206	Shovel Only Base Gasket Std bore .020" Viton Front & Rear Pair, 1966-84	\$24.57
C9207	3 5/8" Shovel Only Base Gasket .020" Viton 2 Fronts for S&S Cylinders, 1984-99	\$24.57
C10038	3 13/16" Shovel Only Base Gasket .020" Viton 2 Fronts for S&S Cylinders	\$24.57
C9987	Panhead Base Front & Rear Set .020" Viton 1948-84	\$24.57
C9988	Panhead Base 3 5/8" Front & Rear Set .020" Viton 1948-84	\$24.57
C9989	Panhead Base 3 5/8" 2 Fronts for S&S Cylinders Viton 48-84	\$24.57
C9893	Panhead Base 3 13/16" .020" Viton 1948-84	\$24.57

## EVO Viton Coated Steel Rocker Cover Gaskets

Part#	Description / Qty.	Thickness	Price	Part#	Description / Qty.	Thickness	Price
C9865	84-99 One piece Base All Evo's (2)	.020"	\$15.84	C9560	Right - All 883 thru 1340, '84-99 (5)	.010"	\$21.82
C9866	84-99 One piece Base All Evo's (10)	.020"	\$79.55	C9561	Right - All 883 thru 1340, '84-99 (5)	.020"	\$21.82
C9556	Right - All 883 thru 1340, '84-99 (1)	.010"	\$4.79	C9562	Left - All 883 thru 1340, '84-99 (5)	.010"	\$25.97
C9557	Right - All 883 thru 1340, '84-99 (1)	.020"	\$4.79	C9563	Left - All 883 thru 1340, '84-99 (5)	.020"	\$25.97
C9558	Left - All 883 thru 1340, '84-99 (1)	.010"	\$5.50	C9986	66-84 Shovelhead / OE#17540-69 (2)	.020"	\$21.82
C9559	Left - All 883 thru 1340, '84-99 (1)	.020"	\$5.50	C10008	66-84 Shovelhead / OE#17540-69 (2)	.043"	\$21.82
				C10008-10	66-84 Shovelhead / OE#17540-69 (10)	.043"	\$109.08







# Gaskets for Harley-Davidson®



Cometic Gasket - An Exclusive NASCAR Performance® Product

## Milwaukee 8®

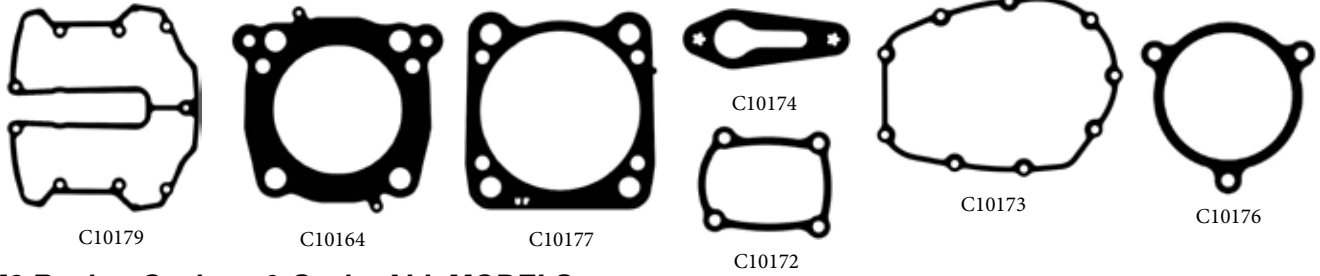

### • M8 Rocker Gaskets & Seals, ALL MODELS

Part#	Description	Year Fitment	OEM#	Price
C10226	MILWAUKEE 8, ROCKER BOX REBUILD KIT	17-19		\$59.74
C10179	MILWAUKEE 8, UPPER ROCKER GASKET, .020"RC, 10PK	17-19	25700372	\$88.07
C10179-2	MILWAUKEE 8, UPPER ROCKER GASKET, .020"RC, 2PK	17-19	25700372	\$19.57
C10183	MILWAUKEE 8 LOWER ROCKER RUBBER, 2PK	17-19	25700425	\$20.60
C10189	MILWAUKEE 8, BREATHER ASSEM O-RING, VITON, 10PK	17-19	11900116	\$9.79
C10202	MILWAUKEE 8, VALVE STEM SEAL, 8PK	17-19	18100044	\$20.39

### • M8 Coolant O-rings ALL MODELS

Part#	Description	Year Fitment	OEM#	Price
C10201	MILWAUKEE 8, COOLANT O-RING, 10PK	17-19	11900090	\$15.45

### • M8 Push Rod O-rings ALL MODELS

Part#	Description	Year Fitment	OEM#	Price
C9294	MILWAUKEE 8, UPPER PUSH-ROD O-RING, 10PK, VITON	17-19	11293	\$10.48
C9459	MILWAUKEE 8, MIDDLE PUSH-ROD O-RING, 25PK, BUNA	17-19	11132A	\$4.04
C9293	MILWAUKEE 8, LOWER PUSH-ROD O-RING, 25PK, BUNA	17-19	11145A	\$8.19
C9586	MILWAUKEE 8, PUSH-ROD O-RING KIT, ALL M8 MODELS	17-19	11133-M8	\$4.45
C9586-M8	MILWAUKEE 8, PUSH-ROD O-RING KIT w/TAPPET GASKETS	17-19	11133-M8	\$10.82

### • M8 Cam Gaskets ALL MODELS

Part#	Description	Year Fitment	OEM#	Price
C10178	MILWAUKEE 8, CAM CHANGE KIT	17-19	25700731	\$29.36
C10178-FP	MILWAUKEE 8, CAM CHANGE KIT w/ROCKER COVER	17-19	25700731	\$46.35
C10173	MILWAUKEE 8, CAM COVER GASKET, .032"AFM, 5PK	17-19	25700370	\$32.19
C10172	MILWAUKEE 8, TAPPET COVER GASKET, .032"AFM, 10PK	17-19	25700362	\$30.13
C10210	MILWAUKEE 8, CAM PLATE TO OIL PUMP, O-RING 10PK	17-19	11900103	\$8.81
C9294	MILWAUKEE 8, OIL PUMP TO ENGINE, O-RING, 10PK	17-19	11293	\$10.48

### • M8 Induction Gaskets ALL MODELS

Part#	Description	Year Fitment	OEM#	Price
C10190	MILWAUKEE 8, MAP SENSOR O-RING, VITON, 10 PK	17-19	32700065	\$9.79
C10176	MILWAUKEE 8, AIRBOX TO T/B CVO MODELS, .031"F, 1PK	17-19	29000149	\$2.52
C10200	MILWAUKEE 8, FUEL INJECTOR O-RING KIT	17-19	91800058-X	\$5.15
C10203	MILWAUKEE 8, SEAL INTAKE MANIFOLD TO HEAD, 4PK	17-19	27300087	\$17.51
C10204	MILWAUKEE 8, SEAL MANIFOLD TO THROTTLE BODY, 4PK	17-19	27300082	\$53.35
C10205	MILWAUKEE 8, REPLACES BLACK INJECTOR O-RING, 10PK	17-19	91800058-B	\$11.59
C10206	MILWAUKEE 8, REPLACES ORANG INJECTOR O-RING, 10PK	17-19	91800058-O	\$11.59
C10207	MILWAUKEE 8, AIR CLEANER TO THOTTLE BODY SEAL, 4PK	17-19	29000108	\$22.15
C10247	MILWAUKEE 8, INTAKE MANIFOLD SERVICE KIT NON-CVO MODELS	17-19	27200038	\$30.90
C10247-CVO	MILWAUKEE 8, INTAKE MANIFOLD SERVICE KIT CVO MODELS	17-19	27200038-CVO	\$27.76

### • M8 Exhaust Gaskets ALL MODELS

Part#	Description	Year Fitment	OEM#	Price
C9247	EVO, TWIN CAM & M8 EX. RACE STYLE .240" THICK, 10PK	17-19	65324-83X	\$59.62
C9247-2	EVO, TWIN CAM & M8 EX. RACE STYLE .240" THICK, 2PK	17-19	65324-83X	\$11.85
C9540	EVO, T/C, M8. HI PERF.EX GASKET SPIRAL WOUND 10-PK	17-19	65324-83X	\$76.80
C9540-2	EVO, T/C, M8. HI PERF.EX GASKET SPIRAL WOUND 2-PK	17-19	65324-83X	\$15.55
C9719	EVO, T/C, M8 RACE STYLE EX. .110" THICK GASKET; 10PK	17-19	65324-83	\$41.63
C9719-2	EVO, T/C, M8 RACE STYLE EX. .110" THICK GASKET; 2PK	17-19	65324-83	\$8.24
C9288	EVO, T/C, M8, OE REPLACEMENT GASKET 10PK	17-19	65324-83A	\$49.24
C9288-2	EVO, T/C, M8, OE REPLACEMENT GASKET 2PK	17-19	65324-83A	\$9.89
C10232	HD MILWAUKEE 8 FXST MUFFLER GASKET STEEL MESH, 2PK	18-19	65900017	\$30.90



**WARNING:** Cancer and Reproductive Harm www.P65Warnings.ca.gov



# Gaskets for Harley-Davidson®



Cometic Gasket - An Exclusive NASCAR Performance® Product

## Milwaukee 8®

### • M8 Head Gaskets Oil & Coolant Cooled

Part#	Description	Year Fitment	OEM#	Price
C10164	MILWAUKEE 8 H/G PR 3.937" .040"MLS,STOCK BORE 107CI	17-19	16500326	\$46.34
C10164-030	MILWAUKEE 8 H/G PR 3.937" .030"MLS,STOCK BORE 107CI	17-19	16500326	\$46.34
C10164-HB-030	MILWAUKEE 8 H/G PR 3.937" .030"MLS H/G, .014" BASE	17-19	16500326	\$61.80
C10165	MILWAUKEE 8 H/G PR 4.00" .040"MLS,STOCK BORE 114CI	17-19	16500305	\$46.34
C10165-030	MILWAUKEE 8 H/G PR 4.00" .030"MLS,STOCK BORE 114CI	17-19	16500305	\$46.34
C10166	MILWAUKEE 8 H/G PR 4.075" .040"MLS,GASKET BORE 4.095"	17-19		\$46.34
C10166-030	MILWAUKEE 8 H/G PR 4.075" .030"MLS,GASKET BORE 4.095"	17-19		\$46.34
C10166-HB-030	MILWAUKEE 8 H/G PR 4.075" .030"MLS H/G, .014" BASE	17-19	16500326	\$61.80
C10167	MILWAUKEE 8 H/G PR 4.125" .040"MLS,GASKET BORE 4.145"	17-19		\$46.34
C10167-030	MILWAUKEE 8 H/G PR 4.125" .030"MLS,GASKET BORE 4.145"	17-19		\$46.34
C10167-036	MILWAUKEE 8 H/G PR 4.125" .036"MLS,GASKET BORE 4.145"	17-19		\$46.34
C10167-045	MILWAUKEE 8 H/G PR 4.125" .045"MLS,GASKET BORE 4.145"	17-19		\$46.34
C10167-HB-030	MILWAUKEE 8 H/G PR 4.125" .030"MLS H/G, .014" BASE	17-19	16500326	\$61.80
C10167-HB-040	MILWAUKEE 8 H/G PR 4.125" .040"MLS H/G, .014" BASE	17-19	16500326	\$61.80
C10168	MILWAUKEE 8 H/G PR 4.185" .040"MLS,GASKET BORE 4.205"	17-19		\$46.34
C10168-030	MILWAUKEE 8 H/G PR 4.185" .030"MLS,GASKET BORE 4.205"	17-19		\$46.34
C10168-036	MILWAUKEE 8 H/G PR 4.185" .036"MLS,GASKET BORE 4.205"	17-19		\$46.34
C10169	MILWAUKEE 8 H/G PR 4.200" .040"MLS,GASKET BORE 4.220"	17-19		\$46.34
C10169-030	MILWAUKEE 8 H/G PR 4.200" .030"MLS,GASKET BORE 4.220"	17-19		\$46.34
C10181	MILWAUKEE 8 H/G PR 4.250" .040"MLS,PAIR	17-19		\$46.34
C10181-030	MILWAUKEE 8 H/G PR 4.250" .030"MLS,PAIR	17-19		\$46.34
C10181-HB	MILWAUKEE 8 H/G PR 4.250" .040"MLS, .014"RC H&B KIT	17-19		\$61.80
C10181-HB-030-014	MILWAUKEE 8 H/G PR 4.250" .030"MLS, .014"RC H&B KIT	17-19		\$61.80
C10181-HB-030-020	MILWAUKEE 8 H/G PR 4.250" .030"MLS, .020"RC H&B KIT	17-19		\$61.80

### • M8 Head Gaskets Oil & Coolant Cooled Heads

**Note: ALL bores over 4.250" on Oil Cooled Heads must have the Oil Holes Welded**

Part#	Description	Year Fitment	Price
C10182	MILWAUKEE 8 H/G PR 4.320" .040"MLS,PAIR, OIL COOLED ONLY	17-19	\$46.34
C10182-030	MILWAUKEE 8 H/G PR 4.320" .030"MLS,PAIR, OIL COOLED ONLY	17-19	\$46.34
C10192	MILWAUKEE 8 H/G PR 4.320" .040"MLS,PAIR, COOLANT COOLED ONLY	17-19	\$46.34
C10192-HB	MILWAUKEE 8 H&B KIT 4.320" .040"HG, .014"BG, COOLANT COOLED ONLY	17-19	\$61.80
C10193	MILWAUKEE 8 H/G PR 4.500" .040"MLS,PAIR, COOLANT COOLED ONLY	17-19	\$46.34
C10193-HB	MILWAUKEE 8 H&B KIT 4.500" .040"HG, .014"BG, COOLANT COOLED ONLY	17-19	\$61.80
C10193-HB-027-014	MILWAUKEE 8 H&B KIT 4.500" .027"HG, .014"BG, COOLANT COOLED ONLY	17-19	\$61.80

### • M8 Base Gaskets ALL MODELS

Part#	Description	Year Fitment	OEM#	Price
C10177	MILWAUKEE 8 BASE GASKET .014" RC, "STOCK THICKNESS" PR	17-19	16500332	\$24.57
C10177-010	MILWAUKEE 8 BASE GASKET .010" RC, PR	17-19	16500332	\$24.57
C10177-020	MILWAUKEE 8 BASE GASKET .020" RC, PR	17-19	16500332	\$24.57
C10177-030	MILWAUKEE 8 BASE GASKET .030" RC, PR	17-19	16500332	\$24.57
C10242	MILWAUKEE 8 BASE GASKET .014" RC,GEN2 EMBOSSING, PR	17-19	16500332	\$24.57
C10242-010	MILWAUKEE 8 BASE GASKET .010" RC,GEN2 EMBOSSING, PR	17-19	16500332	\$24.57
C10242-020	MILWAUKEE 8 BASE GASKET .020" RC,GEN2 EMBOSSING, PR	17-19	16500332	\$24.57
C10242-030	MILWAUKEE 8 BASE GASKET .030" RC,GEN2 EMBOSSING, PR	17-19	16500332	\$24.57
C10194	MILWAUKEE 8 BASE GASKET .014" RC, 4.320" BIG BORE	17-19	16500332	\$24.57
C10195	MILWAUKEE 8 BASE GASKET .014" RC, 4.500" BIG BORE	17-19	16500332	\$24.57

### • M8 Engine Case Gaskets & Seals

Part#	Description	Year Fitment	OEM#	Price
C10174	MILWAUKEE 8,PISTON JET COOLER GASKET,.032"AFM, 2PK	17-19	25700433	\$3.14
C10208	MILWAUKEE 8, OIL PRESSURE CHECK VALVE O-RING, 10K	17-19	11900010	\$11.59
C10209	MILWAUKEE 8, SEAL ENGINE CRANK, 4PK	17-19	11000134	\$20.39



Gaskets for Harley-Davidson®



Cometic Gasket - An Exclusive NASCAR Performance® Product

# Milwaukee 8®

## • M8 Primary Gaskets

Part#	Description	Year Fitment	OEM#	Price
C10196	2017 MILWAUKEE 8 ALL FL PRIMARY & SEAL KIT COMPLETE	17-19	25700746	\$66.95
C10198F1	MILWAUKEE 8 PRIMARY GASKET ALL FL .060"AFM 1PK	17-19	25700378	\$34.74
C10198F5	MILWAUKEE 8 PRIMARY GASKET ALL FL .060"AFM, 5 PK	17-19	25700378	\$156.28
C10248	MILWAUKEE 8, ALL SOFTAIL PRIMARY & SEAL KIT COMPLETE	18-19	25701007	\$66.95
C10241F1	MILWAUKEE 8 PRIMARY GASKET ALL FXST, .032"AFM 1PK	18-19	25700564	\$34.74
C10241F5	MILWAUKEE 8 PRIMARY GASKET ALL FXST, .032"AFM, 5PK	18-19	25700564	\$156.28
C10211	MILWAUKEE 8, PRIMARY TO ENGINE GASKET ALL M8, 1PK	17-19	25700455	\$24.72
C9220	MILWAUKEE 8, SPORT GLIDE, CLUTCH SEAL, 5PK, BUNA	18-19	25463-94A	\$36.49
C9220F1	MILWAUKEE 8, SPORT GLIDE, CLUTCH SEAL, 1PK, BUNA	18-19	25463-94A	\$7.31
C10140F1	DERBY CVR GASKET 5 HOLE ALL FL, 2017,M8, ALL M8 SOFTAIL,2018	17-19	25416-16	\$6.32
C10140F5	DERBY CVR GASKET 5 HOLE ALL FL, 2017, M8, ALL M8 SOFTAIL,2018	17-19	25416-16	\$27.60
C9152F1	CLUTCH COVER SEAL "RUBBER" ALL FL, 2017, M8, M8 SOFTAIL,2018, 1PK	17-19	17369-06	\$6.32
C9152F5	CLUTCH COVER SEAL "RUBBER" ALL FL, 2017, M8, M8 SOFTAIL,2018, 5PK	17-19	17369-06	\$27.60
C9201	O-RING, STARTER TO CASE ALL M8, 5PK	17-19	27444-00Y	\$14.63

## • M8 Top End Gasket Sets for Coolant & Oil Cooled Engines

Part#	Description	Year Fitment	OEM#	Price
C10278	MILWAUKEE 8,T/E, W/OUT HEAD & BASE GASKETS	17-19		\$121.54
C10217	MILWAUKEE 8, 3.937" 107CU, T/E KIT,.040"H/G	17-19	25700729	\$185.40
C10217-030	MILWAUKEE 8, 3.937" 107CU, T/E KIT,.030"H/G	17-19	25700729	\$185.40
C10218	MILWAUKEE 8, 4.00" 114CU, CVO,T/E KIT,.040"H/G	17-19	25700729	\$185.40
C10218-030	MILWAUKEE 8, 4.00" 14CU, CVO,T/E KIT,.030"H/G	17-19	25700729	\$185.40
C10219	MILWAUKEE 8, 4.075" 114CU, T/E KIT,.040"H/G	17-19	25700729	\$185.40
C10219-030	MILWAUKEE 8, 4.075" 114CU, T/E KIT,.030"H/G	17-19	25700729	\$185.40
C10220	MILWAUKEE 8, 4.125" 117CU, T/E KIT,.040"H/G	17-19	25700729	\$185.40
C10220-030	MILWAUKEE 8, 4.125" 117CU, T/E KIT,.030"H/G	17-19	25700729	\$185.40
C10221	MILWAUKEE 8, 4.185" 120CU, T/E KIT,.040"H/G	17-19	25700729	\$185.40
C10221-030	MILWAUKEE 8, 4.185" 120CU, T/E KIT,.030"H/G	17-19	25700729	\$185.40
C10222	MILWAUKEE 8, 4.200" 121CU, T/E KIT,.040"H/G	17-19	25700729	\$185.40
C10222-030	MILWAUKEE 8, 4.200" 121CU, T/E KIT,.030"H/G	17-19	25700729	\$185.40
C10223	MILWAUKEE 8, 4.250" 124CU,T/E KIT040"H/G	17-19	25700729	\$185.40
C10223-030	MILWAUKEE 8, 4.250" 124CU,T/E KIT030"H/G	17-19	25700729	\$185.40

## • M8 Top End Gasket Sets for Coolant & Oil Cooled Heads

**Note: ALL bores over 4.250" on Oil Cooled Heads must have the Oil Holes Welded**

Part#	Description	Year Fitment	OEM#	Price
C10224	MILWAUKEE 8, 4.320"128CU,T/E KIT040"H/G	17-19	25700729	\$185.40
C10225	MILWAUKEE 8, 4.500" 139CU,T/E KIT040"H/G	17-19	25700729	\$185.40

## • M8 Engine only Gasket Sets for Oil & Coolant Cooled Engines

Part#	Description	Year Fitment	Price
C10279	MILWAUKEE 8 ENGINE ONLY,W/OUT HEAD & BASE GASKETS	17-19	\$142.14
C10250	MILWAUKEE 8, ALL MODELS 3.937", 107CU ENGINE GASKET KIT,.040"H/G	17-19	\$206.00
C10250-030	MILWAUKEE 8, ALL MODELS 3.937", 107CU ENGINE GASKET KIT,.030"H/G	17-19	\$206.00
C10251	MILWAUKEE 8, ALL MODELS 4.00", 114CU ENGINE GASKET KIT,.040"H/G	17-19	\$206.00
C1051-030	MILWAUKEE 8, ALL MODELS 4.00", 114CU ENGINE GASKET KIT,.030"H/G	17-19	\$206.00
C10252	MILWAUKEE 8, ALL MODELS 4.075", 117CU ENGINE GASKET KIT,.040"H/G	17-19	\$206.00
C10252-030	MILWAUKEE 8, ALL MODELS 4.075", 117CU ENGINE GASKET KIT,.030"H/G	17-19	\$206.00
C10253	MILWAUKEE 8, ALL MODELS 4.125", 117CU ENGINE GASKET KIT,.040"H/G	17-19	\$206.00
C10253-030	MILWAUKEE 8, ALL MODELS 4.125", 117CU ENGINE GASKET KIT,.030"H/G	17-19	\$206.00
C10254	MILWAUKEE 8, ALL MODELS 4.185", 120CU ENGINE GASKET KIT,.040"H/G	17-19	\$206.00
C10254-030	MILWAUKEE 8, ALL MODELS 4.185", 120CU ENGINE GASKET KIT,.030"H/G	17-19	\$206.00
C10255	MILWAUKEE 8, ALL MODELS 4.200", 124CU ENGINE GASKET KIT,.040"H/G	17-19	\$206.00
10255-030	MILWAUKEE 8, ALL MODELS 4.200", 124CU ENGINE GASKET KIT,.030"H/G	17-19	\$206.00
C10256	MILWAUKEE 8, 4.250" 124CU, ENGINE GASKET KIT,.040"H/G	17-19	\$206.00
C10256-030	MILWAUKEE 8, 4.250" 124CU, ENGINE GASKET KIT,.030"H/G	17-19	\$206.00

All Component Parts can be purchased individually.



**WARNING:** Cancer and Reproductive Harm www.P65Warnings.ca.gov





# Gaskets for Harley-Davidson®



Cometic Gasket - An Exclusive NASCAR Performance® Product

## Milwaukee 8®

### • M8 Engine only Gasket Sets for Coolant & Oil Cooled engines

**Note: ALL bores over 4.250" on Oil Cooled Heads must have the Oil Holes Welded**

Part#	Description	Year Fitment	Price
C10257	MILWAUKEE 8, 4.320" 128CU, ENGINE GASKET KIT, .040"H/G	17-19	\$206.00
C10257-030	MILWAUKEE 8, 4.320" 128CU, ENGINE GASKET KIT, .030"H/G	17-19	\$206.00
C10258	MILWAUKEE 8, 4.500" 139CU, ENGINE GASKET KIT, .040"H/G	17-19	\$206.00
C10258-030	MILWAUKEE 8, 4.500" 139CU, ENGINE GASKET KIT, .030"H/G	17-19	\$206.00

### • M8 Complete Engine & Primary Gasket Sets All Milwaukee 8 Touring Model, Coolant & Oil Cooled

Part#	Description	Year Fitment	Price
C10280	MILWAUKEE 8, ALL FL W/PRIMARY, NO HEAD & BASE	17-19	\$198.79
C10260	MILWAUKEE 8, ALL FL MODELS 3.937", 107CU, .040"H/G	17-19	\$262.65
C10260-030	MILWAUKEE 8, ALL FL MODELS 3.937", 107CU, .030"H/G	17-19	\$262.65
C10261	MILWAUKEE 8, ALL FL MODELS 4.00", 114CU, .040"H/G	17-19	\$262.65
C10261-030	MILWAUKEE 8, ALL FL MODELS 4.00", 114CU, .030"H/G	17-19	\$262.65
C10262	MILWAUKEE 8, ALL FL MODELS 4.075", 117CU, .040"H/G	17-19	\$262.65
C10262-030	MILWAUKEE 8, ALL FL MODELS 4.075", 117CU, .030"H/G	17-19	\$262.65
C10263	MILWAUKEE 8, ALL FL MODELS 4.125", 117CU, .040"H/G	17-19	\$262.65
C10263-030	MILWAUKEE 8, ALL FL MODELS 4.125", 117CU, .030"H/G	17-19	\$262.65
C10264	MILWAUKEE 8, ALL FL MODELS 4.185", 120CU, .040"H/G	17-19	\$262.65
C10264-030	MILWAUKEE 8, ALL FL MODELS 4.185", 120CU, .030"H/G	17-19	\$262.65
C10265	MILWAUKEE 8, ALL FL MODELS 4.200", 124CU, .040"H/G	17-19	\$262.65
C10265-030	MILWAUKEE 8, ALL FL MODELS 4.200", 124CU, .030"H/G	17-19	\$262.65
C10266	MILWAUKEE 8, ALL FL MODELS 4.250" 124CU, .040"H/G	17-19	\$262.65
C10266-030	MILWAUKEE 8, ALL FL MODELS 4.250" 124CU, .030"H/G	17-19	\$262.65

### • M8 Complete Engine & Primary Gasket Sets All M8 Touring Model, Coolant & Oil Cooled

**Note: ALL bores over 4.250" on Oil Cooled Heads must have the Oil Holes Welded**

Part#	Description	Year Fitment	Price
C10267	MILWAUKEE 8, ALL FL MODELS 4.320" 128CU, .040"H/G	17-19	\$262.65
C10267-030	MILWAUKEE 8, ALL FL MODELS 4.320" 128CU, .030"H/G	17-19	\$262.65
C10268	MILWAUKEE 8, ALL FL MODELS 4.500" 139CU, .040"H/G	17-19	\$262.65
C10268-030	MILWAUKEE 8, ALL FL MODELS 4.500" 139CU, .030"H/G	17-19	\$262.65

### • M8 Complete Engine & Primary Gasket Sets All M8 Softail Models

Part#	Description	Year Fitment	Price
C10281	MILWAUKEE 8, ALL FXST W/PRIMARY, NO HEAD & BASE	18-19	\$198.79
C10269	MILWAUKEE 8, ALL SOFTAIL MODELS 3.937", 107CU, .040"H/G	18-19	\$262.65
C10269-030	MILWAUKEE 8, ALL SOFTAIL MODELS 3.937", 107CU, .030"H/G	18-19	\$262.65
C10270	MILWAUKEE 8, ALL SOFTAIL MODELS 4.00", 114CU, .040"H/G	18-19	\$262.65
C10270-030	MILWAUKEE 8, ALL SOFTAIL MODELS 4.00", 114CU, .030"H/G	18-19	\$262.65
C10271	MILWAUKEE 8, ALL SOFTAIL MODELS 4.075", 117CU, .040"H/G	18-19	\$262.65
C10271-030	MILWAUKEE 8, ALL SOFTAIL MODELS 4.075", 117CU, .030"H/G	18-19	\$262.65
C10272	MILWAUKEE 8, ALL SOFTAIL MODELS 4.125", 117CU, .040"H/G	18-19	\$262.65
C10272-030	MILWAUKEE 8, ALL SOFTAIL MODELS 4.125", 117CU, .030"H/G	18-19	\$262.65
C10273	MILWAUKEE 8, ALL SOFTAIL MODELS 4.185", 120CU, .040"H/G	18-19	\$262.65
C10273-030	MILWAUKEE 8, ALL SOFTAIL MODELS 4.185", 120CU, .030"H/G	18-19	\$262.65
C10274	MILWAUKEE 8, ALL SOFTAIL MODELS 4.200", 124CU, .040"H/G	18-19	\$262.65
C10274-030	MILWAUKEE 8, ALL SOFTAIL MODELS 4.200", 124CU, .030"H/G	18-19	\$262.65
C10275	MILWAUKEE 8, ALL SOFTAIL MODELS 4.250" 124CU, .040"H/G	18-19	\$262.65
C10275-030	MILWAUKEE 8, ALL SOFTAIL MODELS 4.250" 124CU, .030"H/G	18-19	\$262.65

### • M8 Complete Engine & Primary Gasket Sets All M8 Softail Models

**Note: ALL bores over 4.250" on Oil Cooled Heads must have the Oil Holes Welded**

Part#	Description	Year Fitment	Price
C10276	MILWAUKEE 8, ALL SOFTAIL MODELS 4.320" 128CU, .040"H/G	18-19	\$262.65
C10276-030	MILWAUKEE 8, ALL SOFTAIL MODELS 4.320" 128CU, .030"H/G	18-19	\$262.65
C10277	MILWAUKEE 8, ALL SOFTAIL MODELS 4.500" 139CU, .040"H/G	18-19	\$262.65
C10277-030	MILWAUKEE 8, ALL SOFTAIL MODELS 4.500" 139CU, .030"H/G	18-19	\$262.65





## Milwaukee 8®

### • M8 Transmission Gasket Sets

Part#	Description	Year Fitment	OEM#	Price
C10197	MILWAUKEE 8 TRANS. W/ OIL PAN GSKT REBUILD, ALL FL.....	17-19		\$77.50
C10249	MILWAUKEE 8 TRANS. W OIL PAN GSKT REBUILD, ALL SOFTAIL.....	18-19		\$99.40
C10212	MILWAUKEE 8, OIL RETURN O-RING,TRANS PLUG, 10PK, OIL COOLED.....	17-19	11900092	\$8.81
C10213	MILWAUKEE 8, TRANS SHIFT SHAFT SEAL,ALL M8 MODELS, 5PK.....	17-19	11000101	\$18.03
C10214	MILWAUKEE 8, ENGINE TO TRAN GASKET,ALL M8 MODELS, 1PK.....	17-19	24400215	\$8.81
C10215	MILWAUKEE 8, OIL PAN GASKET ALL FL MODELS,.032"AFM, 1PK.....	17-19	25700452	\$16.43
C10216	MILWAUKEE 8, TRANS TOP LID ALL FL,.060"AFM GASKET, 1PK.....	17-19	25700453	\$6.13
C9187	BEARING CVR GSKT,.032"AFM ALL M8 MODELS, 10PK.....	17-19	35654-06	\$26.68
C9187F5	BEARING CVR GSKT,.032"AFM ALL M8 MODELS, 5PK.....	17-19	35654-06	\$12.97
C9188	CLUTCH RELEASE CVR.GSKT,.032"AFM ALL M8 MODELS, 10PK.....	17-19	36805-06	\$25.74
C9188F5	CLUTCH RELEASE CVR.GSKT,.032"AFM ALL M8 MODELS, 5PK.....	17-19	36805-06	\$12.86
C9200	TRANS OUTPUT SEAL, ALL M8 MODELS 10PK.....	17-19	12077	\$69.60
C9200F1	TRANS OUTPUT SEAL, ALL M8 MODELS 1PK.....	17-19	12077	\$6.75
C9215	TRANS M/S SEAL, ALL M8 MODELS 1PK.....	17-19	12074	\$10.41
C9434	5TH GEAR M/S, ALL M8 MODELS 10PK.....	17-19	11187/11201	\$8.19
C9435	ENGINE,TRANS DRAIN PLUG, ALL M8 MODELS, 10PK.....	17-19	11105/11102/11273	\$4.68
C9459	TRANS OIL FILL O-RING, ALL M8 MODELS, 25PK.....	17-19	11132	\$4.04
C9668	SPEED SENSOR O-RING ALL M8 MODELS, 25PK.....	17-19	11241/11140/11289	\$4.04
C9961	OIL DIP STICK O-RING, ALL M8 MODELS, 5 PCK.....	17-19	11120	\$4.04
C10243	MILWAUKEE 8, OIL PAN GASKET .032", ALL FXST MODELS, 1PK.....	18-19	25700593	\$16.43
C10244	MILWAUKEE 8, DIP STICK O-RING ALL FXST MODELS, 10PK.....	18-19	62700212	\$15.45
C10245	MILWAUKEE 8, OIL FILL SPOUT SEAL ALL FXST MODELS, 1PK.....	18-19	62800053	\$2.58
C10246	MILWAUKEE 8, TRANS TOP COVER GASKET, ALL FXST 1PK.....	18-19	34800044	\$18.49

### Cometic Installation Procedure for Harley Davidson Milwaukee 8 MLS Head Gaskets

- Check all gasket surfaces for flatness and imperfections, an excessively rough finish may cause gasket failure.
- A surface finish on both the head and cylinder of 50RA or finer is recommended.
- Check all hardware for defects.
  - Bores 3.937" to 4.250" use the triangular shaped embossments on both Oil and Coolant cooled heads.
  - All Oil Cooled heads on larger than 4.250" bores **MUST BE WELDED**. The oil port is exposed to the bore.
  - Coolant Cooled heads require the circular embossments on bores larger than 4.250".
- Clean all threads and lubricate both threads and the underside of the bolt flanges with a light machine oil. Wipe away any excess.
- All surfaces must be clean and dry.
- **No sealants are required when installing a Cometic MLS gasket.**

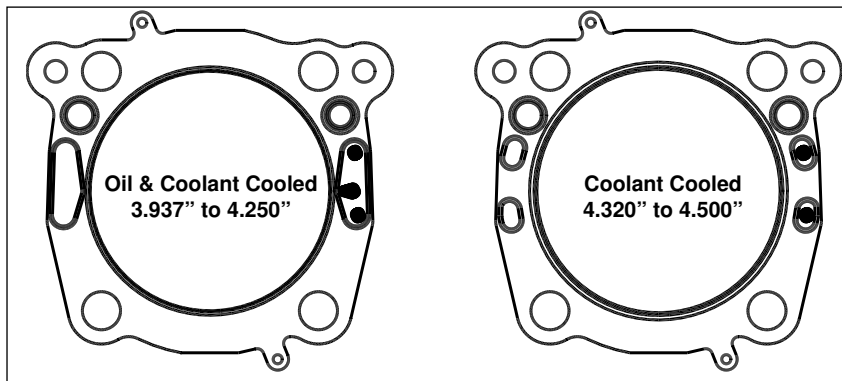

### Cometic recommends following all OE Torque Procedures in the service manual.

1. Tighten the head bolts in the recommended X pattern to 20-30ft-lbs.
2. Loosen all head bolts one turn.
3. Tighten all head bolts using recommended X pattern to 9-11ft-lbs.
4. Tighten all head bolts using recommended X pattern to 25-27ft-lbs.
5. Final torque is a 90 degree turn using the recommended X pattern.





# Gaskets for Harley-Davidson®



Cometic Gasket - An Exclusive NASCAR Performance® Product

## Twin Cam®

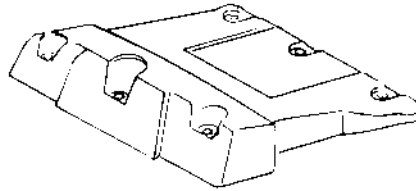

**Cometic Part #-C9577**  
Rocker Cover  
All 1999-17  
Replaces: 17286-99

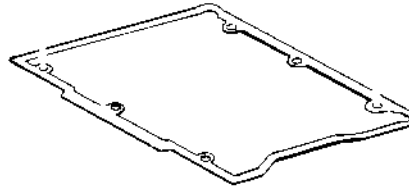

**Cometic Part #-C9579**  
Breather Cover  
All 1999-10  
Replaces: 17591-99

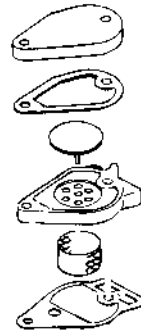

**Cometic Part #-C9633**  
Rocker Umbrella Valve  
All 1999-17  
Replaces: 26858-99

**Cometic Part #-C9294**  
Pushrod Cover  
O-Ring Upper  
Replaces: 11293

**Cometic Part #-C9629**  
Rocker Arm Support  
O-Ring  
All 1999-17  
Replaces: 11270

**Cometic Part #-C9679**  
Breather Baffle Element  
All 1999-17  
Replaces: 63815-99

**Cometic Part #-C9580**  
Breather Baffle Housing  
All 1999-10  
Replaces: 17592-99

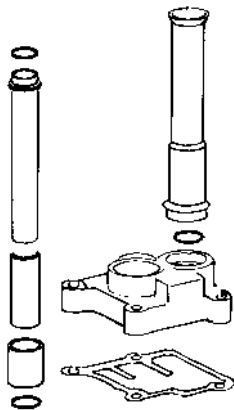

**Cometic Part #-C9293**  
Pushrod Cover  
O-Ring Lower  
Replaces: 11145

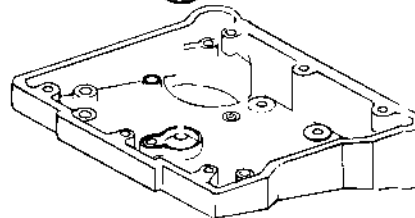

**Cometic Part #-C9576**  
Rocker Housing  
All 1999-17  
Replaces: 16719-99

**Cometic Part #-C9459**  
Pushrod Cover  
O-Ring Middle  
Replaces: 11132

**Cometic Part #-C9578**  
Lifter Cover 1999-17  
Replaces: 18635-99

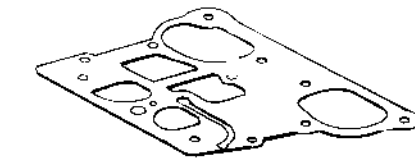

**Cometic Part #-C9836**  
Valve Stem Seal Viton  
All 1999-03  
Replaces: 18001-83B

**Cometic Part #-C9153**  
Valve Stem Seal Hat Style  
Viton  
2003-17  
Replaces: 18094-02

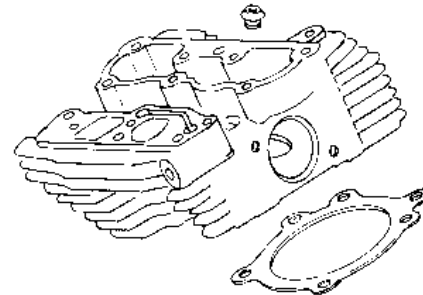

**Cometic Part #-C9790** Std. Bore Head - MLS .030" - All 1999-17  
**Cometic Part #-C9745** Std. Bore Head - MLS .040" - All 1999-17  
**Cometic Part #-C9721** 1550 Big Bore Head - MLS .030" - All 1999-17  
**Cometic Part #-C9722** 1550 Big Bore Head - MLS .040" - All 1999-17





Complete • Top End • Rocker Box Kits & Individual Replacement Parts

Table with columns: Part #, Description, Price. Includes sections for EST TWIN CAM HI-PERFORMANCE KITS, Complete Gasket Kit, Top End Gasket Kit, and Motor Only Gasket Kit.





# Gaskets for Harley-Davidson®



Cometic Gasket - An Exclusive NASCAR Performance® Product

## Complete • Top End • Rocker Box Kits & Individual Replacement Parts

Part #	Description	Price
<b>• Rocker Box Gasket Kit for 88", 95" &amp; 103" Twin Cam</b>		
C9588	99-17 88", 95" & 103" Twin Cam Rocker Box Gasket Kit, inc. gaskets for '11 Breathers	\$34.17
C9167	99-17 Screamin Eagle Heads Rocker Box Rebuild w/seals for .530" O.D. guides	\$42.34
C9840	1999-17 Twin Cam FATSO Rocker Box Rebuild Kit	\$32.87
C9155	S&S Rocker Box Rebuild Kit (Die Cast Box)	\$56.97
<b>• Twin Cam Engine &amp; Trans Cover Gasket Kit Perfect for covers being chromed or powder coated</b>		
C10099	Twin Cam 96 All FL Models, Engine and Trans Cover Gaskets Only	\$94.54

Cometic Part #	OEM Part #	Description	Pkg. Qty.	Price
----------------	------------	-------------	-----------	-------

### TWIN CAM INDIVIDUAL REPLACEMENT GASKETS,SEALS, O-RINGS 1999-17

#### • Cam Service Kits for Twin Cam

C9664	17045-99	Cam Service Kit All T/C Models 1999 -17	KIT	\$55.80
-------	----------	---	-----	---------

#### Twin Cooled Coolant Service Parts

C10139	26064-08X	14-16 Twin Cooled O-Ring Kit	KIT	\$23.00
--------	-----------	------------------------------	-----	---------

#### • Rocker Box Assembly Gaskets

C9577	17286-99	Rocker Cover Gasket All Models 1999 -17 .020" Rubber Coated Steel	10	\$81.36
C9579	17591-99	Breather Cover Gasket All Models 1999 -10	10	\$10.59
C9633	26858-99	Rocker Cover Umbrella Vlv All Models 1999 -17	10	\$40.36
C9679	63815-99	Breather Filter Element All Models 1999 -17	10	\$15.55
C9580	17592-99	Breather Baffle Gasket All Models 1999 -10	10	\$10.59
C10039	26500002	Breather element gasket All Twin Cam 2011-17	10	\$15.55
C9576	16719-99	Rocker Housing Gasket All Models 1999 -17 .020" Rubber Coated Steel	10	\$81.36
C9629	11270	Rocker Arm Support O-ring All Models 1999 -17	10	\$4.14

#### • Pushrod, Tappet Gaskets and Valve Stem Seals

C9586		Pushrod Seal Kit, All Twin Cam Models, 1999-17	KIT	\$4.45
C9294	11293	Pushrod Cvr O-ring UPPER all Models 1999 -17	10	\$10.48
C9459	11132	Pushrod Cvr O-ring MIDDLE all Models 1999 -17	25	\$4.04
C9293	11145	Pushrod Cvr O-ring LOWER all Models 1999 -17	25	\$8.19
C9578F	18635-99	Lifter Cvr Gasket All Models 1999 -17	10	\$7.01
C9166		Viton Valve Seals for Screamin Eagle Heads or .530" O.D. guides	10	\$31.29
C9836		Valve Stem Oil Seal All Models 1999 -02( Viton )	25	\$75.62
C9153	18094-02	Valve Stem Oil Seal Hat Style All Models 03-17 (Viton)	25	\$98.60

#### • Head and Base Gaskets

C9790	16775-99	Head Gasket 3.750" .030" Spring Steel All Models Std Bore '99 -17	2	\$46.34
C9745		Head Gasket 3.750" .040" Spring Steel All Models Std Bore '99 -17	2	\$51.36
C9721		Head Gasket 3.875" .030" Spring Steel All Models 1999-17	2	\$46.34
C9722		Head Gasket 3.875" .040" Spring Steel All Models 1999-17	2	\$46.34
C9894		3.937" Head Gasket .030" MLS All Twin Cam Models 99-17	2	\$46.34
C9894-040		3.937" Head Gasket .040" MLS All Twin Cam Models 99-17	2	\$46.34
C9894-051		3.937" Head Gasket .051" MLS All Twin Cam Models 99-17	2	\$46.34
C9725		4.00" Head Gasket Twin Cam All Models .030" Spring Steel '99-17	2	\$46.34
C9726		4.00" Head Gasket Twin Cam All Models .040" Spring Steel '99-17	2	\$46.34
C9070-030		4.060" Bore .030" MLS Head Gasket Twin Cam, 99-17	2	\$46.34
C9070-040		4.060" Bore .040" MLS Head Gasket Twin Cam, 99-17	2	\$46.34
C9910		4.125" Bore .030" MLS All Twin Cam Models 1999 - 17	2	\$46.34
C9743		4.125" Bore .040" MLS All Twin Cam Models 1999 - 17	2	\$46.34
C9076-030		4.250" Bore .030" MLS Head Gasket Twin Cam, 99-17	2	\$46.34
C9076-040		4.250" Bore .040" MLS Head Gasket Twin Cam, 99-17	2	\$46.34
C9628	11256	Cylinder Base O-ring All Models 1999 -17	10	\$17.14
C9438	11273	Cylinder Locating Dowel O-ring All Models 1999 -17	10	\$6.78







## Complete • Top End • Rocker Box Kits & Individual Replacement Parts

Cometic Part #	OEM Part #	Description	Pkg. Qty.	Price
<b>• Motor Case O-rings and Seals</b>				
C9287	26432-76A	Engine Case Locating Dowel O-ring 1999 -17	10	\$12.29
C9667	11289	Crankshaft Position Sensor O-ring 1999 -17	25	\$4.04
C9632	12068	Motor Sprocket Shaft Oil Seal 1999 -17	5	\$31.88
C9201	27444-00Y	O-ring Starter to primary case 07-16 All Twin Cam, 06-17 Dyna	5	\$14.63
<b>• Intake and Exhaust Gaskets</b>				
C9247		Exhaust Gasket All Models 99 -17 "Race Style" .240" thick	10	\$59.62
C9540		Exhaust Gasket All Models 99 -17 "Extreme Performance"	10	\$76.80
C9719		Exhaust Gasket All Models 99 - 17 "Race Style"	10	\$41.63
C9288	65324-83A	Exhaust Gasket All Models 99 -17 "Tapered"	10	\$49.24
C9290	26995-86B	Intake Manifold to Head 1999 -17 for Carb & EFI Models	10	\$20.47
C9223		S&S Big Bore Manifold to Head Seal	4	\$19.12
C9131		All Twin Cam Carb Models, Int. Manifold Seal Kit, 1999-02	Kit	\$10.29
C9088	27002-89	Carb.to Intake Manifold Seal All Models 1999-02	1	\$6.78
C9227		50mm Carb. to Manifold Seal 1999-17	1	\$5.03
<b>• Oil and Oil Pump Gaskets</b>				
C10032	17045-99A	99-06 Oil Pump Re-build kit All Twin Cams	1	\$12.05
C10033	17045-99C	07-17 Oil Pump Re-build kit All Twin Cams	1	\$10.44
C9437	11286	Outer Oil Pump O-ring All Models 1999-06, Dyna 05	10	\$3.04
C9449	11301	Cam plate to engine case O-ring All Models 1999-17	10	\$9.54
C9294	11293	Oil Pump to engine case O-ring All Models 1999-17	10	\$10.48
C9294	11293	Oil Filter Mnt Brkt O-ring All Models 1999-17	10	\$10.48
C9667	11140	Piston Cooling Jet O-ring All Models 1999-17	10	\$4.04
C9646F	26072-99	Oil Pan Gasket DYNA 1999-17	10	\$95.10
C9647F	26077-99	Oil Pan Gasket (1) FLT 1999-17	10	\$95.10
<b>• Primary Housing Gaskets</b>				
C9179F1	34901-07	07-16 FL Models Primary Gasket	1	\$34.74
C9145F1	60547-06	06-17 Dyna, 07-17 Softail	1	\$34.74
C9307F5	34901-94	Primary Gasket FLT, FXR 1994-06, AFM .060	5	\$156.28
C9309F5	60539-89	Primary Gasket Softail 1989-06, Dyna 1989-05, AFM .060	5	\$156.28
C9662	25416-99	Derby Cover O-ring All Big Twin Models 99-06, Dyna 99-05	5	\$19.88
C9997F1	25416-99C	99-14 Derby Cover Gasket Replaces O-ring, 5 hole	1	\$6.32
C9183F1		84-98 All Derby Cover Gasket Replaces O-ring, 3 hole	1	\$6.32
C9152F1	17369-06	06-17 Dyna, 07-17 All Twin Cam Models, O-ring Derby Cover	1	\$6.32
C9305F5	34906-85A	Inspection Cover Gasket FLT, FXR Models 1999 -06, AFM .060	5	\$33.16
C9331F5	60567-90A	Ins. Cover Dyna Models '99-05, Softail 00-06 Models, .060" AFM	5	\$23.87
C9441	11147	Inner Primary to Case O-ring All Models 99-06, Dyna 99-05	10	\$23.22
C9199F1	34934-06	06 Dyna, 07-17 All T/C Inner Primary spacer/seal	1	\$27.49
C9260	12052	Wet Clutch Oil Seal All Models 1999-17	5	\$12.29
C9261	12066	Starter Motor Shaft Oil Seal All Models 99-06, Dyna 99-05	5	\$19.12
C9201	27444-00Y	Starter Motor Shaft Oil Seal Dyna 06-17, All Models 07-16	5	\$14.63
<b>• Cam Housing</b>				
C10047		99-17 All Twin Cam, Cam Service kit with Rocker Box kit	1	\$70.04
C9627	11288	Cam Position Sensor O-ring All Models 1999-00	10	\$6.08
C9631	11298	Cam Support Plate Plug O-ring All Models 99-06, Dyna 99-05	10	\$3.88
C9575F5	25244-99	Cam Cover Gasket All Models 1999-17, AFM .060	5	\$54.04
<b>• Carb and EFI Gaskets</b>				
C10007	29645-08	HD All FL Models 08-16, Air Filter Element Gasket	10	\$26.76
C9626F	29062-95	Twin Cam Carb to Backing Plt. Gasket Carb Models 1999-02	10	\$17.49
C9634F	29313-95	Twin Cam Air Filter Mnt. Gasket Carb Models 1999- 02	10	\$18.01
C9641F	29368-99	EFI T/C Ind Module to Bck Plt Gasket 1999-17	10	\$19.19
C9643F	29463-99	EFI T/C Filter Element Gskt EFI Only 1999-17	10	\$22.57
C9630	11291	EFI T/C MAP Sensor Seal EFI Only 1999-17	10	\$16.43
C10072	27270-95	Air Temp Sensor Gasket, 1995-05, .039" Fiber	10	\$16.33
C10073	27635-01B	Induction Module O-ring Kit, 2001-05 Fuel Injected Models	KIT	\$15.70
C10074	27628-01A	Idle Air Control Motor O-Ring, 2001-05 Fuel Injected Models	10	\$12.26
C10075	27655-06	IAFM O-ring Kit, 2006-17 Fuel Injected Models	Kit	\$9.29
C10076	27659-06	TPS Sensor O-Ring, 2006-17 Twin Cams, 2006-07 Touring	10	\$12.88





# Gaskets for Harley-Davidson®



Cometic Gasket - An Exclusive NASCAR Performance® Product

## Evo Big Twin®

**Cometic Part #-C9459**  
Pushrod O-Ring  
Middle 1984-99  
Replaces: 11132

**Cometic Part #-C9481**  
Umbrella Valve Seal  
1993-99  
Replaces: 26856-89

**Cometic Part #-C9286**  
Rocker Cover Washer  
1984-99  
Replaces: 63858-49

**Cometic Part #-C9278**  
Upper Rocker Cover  
1992-99  
Replaces: 17356-92

**Cometic Part #-C9293**  
Pushrod O-Ring  
Lower 1984-99  
Replaces: 11145

**Cometic Part #-C9292**  
Pushrod O-Ring  
Upper 1984-99  
Replaces: 11157

**Cometic Part #-C9282**  
Lower Rocker Cover  
1992-99  
Replaces: 17355-92

**Cometic Part #-C9297**  
Rear Tappet Block  
Replaces: 18633-48D  
**Cometic Part #-C9298**  
Front Tappet Block  
Replaces: 18634-48C

**Cometic Part #-C9283**  
Inner Rocker Cover  
1984-99  
Replaces: 17358-84A

**Cometic Part #-C9328**  
Cam Cover 1993-99  
Replaces: 25225-93  
**Cometic Part #-C9302**  
Cam Cover 1984-92  
Replaces: 25225-70B

**Cometic Part #-C9865**  
One Piece Rocker Base  
1984-99  
Replaces: 16778-97X & 16779-97X

**Cometic Part #-C9435**  
Check Valve & Check Ball Cap O-Ring,  
All Big Twins Replaces: 11105

**Cometic Part #-C9350**  
Cam Seal 1984-99  
Replaces: 83162-51DL

**Cometic Part #-C9836**  
Valve Stem Seal  
1984-99  
Replaces: 18001-83A

**Cometic Part #-C9384**  
Oil Pump Cover 1992-99  
Replaces: 26276-92  
**Cometic Part #-C9382**  
Oil Pump Cover 1984-91  
Replaces: 26276-80A

**Cometic Part #-C9383**  
Oil Pump Body 1992-99  
Replaces: 26273-92  
**Cometic Part #-C9381**  
Oil Pump Body 1984-91  
Replaces: 26273-80B

**Cometic Part #-C9290**  
Intake Manifold Seal  
1990-99  
Replaces: 26995-86A

**Cometic Part #-C9349**  
Oil Pump Drive Gear Seal, 1984-99  
Replaces: 26227-58

**Cometic Part #-C9719**  
Race Style Exhaust  
1984-99 "Flat"  
Replaces: 65424-83  
**Cometic Part #-C9288**  
Std. Exhaust "Tapered"  
Replaces: 65324-83A

**Cometic Part #-C9684**  
Oil Pump Lower Cover O-Ring All Big Twins, 1992-98  
Replaces: 11241

**Cometic Part #-C9688** Std. Bore Head - MLS .030" - 1984-99  
**Cometic Part #-C9689** Std. Bore Head - MLS .040" - 1984-99



Gaskets for Harley-Davidson®



Cometic Gasket - An Exclusive NASCAR Performance® Product

Complete • Top End • Rocker Box Kits & Individual Replacement Parts

Table with columns: Part #, Description, Price. Includes sub-sections: EST BIG TWIN EVOLUTION MOTOR KITS, Complete Gasket Kit, Big Bore Complete Gasket Kit, Top End Gasket Kit, Evo Big Twin Motor Only Gasket Kit, Big Bore Top End Gasket Kit, Rocker Box Rebuild Gasket Kit.

Complete • Top End • Rocker Box Kits & Individual Replacement Parts

Table with columns: Cometic Part #, OEM Part #, Description, Pkg. Qty., Price. Sub-section: 1984-99 BIG TWIN & EVO INDIVIDUAL REPLACEMENT GASKETS, SEALS, O-RINGS, Rocker Box Gaskets.

WARNING: Cancer and Reproductive Harm www.P65Warnings.ca.gov





**Gaskets for Harley-Davidson®**



Cometic Gasket - An Exclusive NASCAR Performance® Product

## Complete • Top End • Rocker Box Kits & Individual Replacement Parts

Cometic Part #	OEM Part #	Description	Pkg. Qty.	Price
<b>1984-99 BIG TWIN &amp; EVO INDIVIDUAL REPLACEMENT GASKETS,SEALS, O-RINGS</b>				
<b>Rocker Box Gaskets</b>				
C9561	16778-97X	84-99 Lower Right Rocker Gasket .020" rubber coated steel	5	\$21.82
C9285	16778-84A	84-99 Lower Right Rocker Gasket fiber	5	\$10.88
C9563	16779-97X	84-99 Lower Left Rocker Gasket .020" rubber coated steel	5	\$25.97
C9284	16779-84A	84-99 Lower Left Rocker Gasket fiber	5	\$17.73
C9865		84-99 One piece Rocker Base all Evo's .020" rubber coated steel	2	\$15.84
C9866		84-99 One piece Rocker Base all Evo's .020" rubber coated steel	10	\$79.55
C9224		S&S Outer Rocker Gasket w/ Breather Flapper	4	\$41.61
C9225		S&S Inner Rocker O-Ring Seal	8	\$13.05
C9226		S&S Rocker Cover Bolt Washer Seal	24	\$23.62
<b>• Pushrod and Tappet Guide Gaskets</b>				
C9292	11157	84-99 Upper Pushrod Tube O-ring	25	\$20.94
C9459	11132	84-99 Middle Pushrod Tube O-ring	25	\$4.04
C9293	11145	84-99 Lower Pushrod Tube O-ring	25	\$8.19
C10023		84-99 Tappet Block Pair Front & Rear .060" AFM Pair	2	\$9.13
C9297F	18633-48D	84-99 Rear Tappet Block Gasket AFM	10	\$6.78
C9298F	18634-48C	84-99 Front Tappet Block Gasket AFM	10	\$8.19
C9586		84-99 Evo Pushrod O-ring Set	Kit	\$4.45
C9836		84-99 Valve Guide Seals "Viton"	25	\$75.62
<b>• Head and Base Gaskets</b>				
C9688		Stock Bore EVO's 3.500" through 3.570" .030" MLS Design	2	\$46.34
C9689		Stock Bore EVO's 3.500" through 3.570" .040" MLS Design	2	\$46.34
C9690		3 5/8" Big Bore EVO's .030" MLS Design	2	\$46.34
C9691		3 5/8" Big Bore EVO's .040" MLS Design	2	\$46.34
C9694		3 3/4" Big Bore EVO's .030" MLS Design	2	\$46.34
C9695		3 3/4" Big Bore EVO's .040" MLS Design	2	\$46.34
C9692		3 13/16" Big Bore EVO's .030" MLS Design	2	\$46.34
C9693		3 13/16" Big Bore EVO's .040" MLS Design	2	\$46.34
C9287	26432-76A	84-99 Cylinder Stud Insert O-ring	10	\$12.29
C9551		84-99 Stock Sleeve Cylinder Base Gasket .020" Rubber Coated Steel	2	\$24.57
C9009	16774-86	84-99 Stock Sleeve Cylinder Base Gasket .020" Fiber	2	\$4.62
C9615	16777-86S	84-99 3 5/8" Base Gasket .020" Fiber	2	\$8.25
C10009	93-1033	84-99 3 5/8" Base Gasket .020" Fiber fits S&S cylinder only	2	\$24.57
C9552		84-99 3 5/8" Base Gasket .020" Rubber Coated Metal	2	\$24.57
C9615		84-99 3 3/4" Base Gasket .020" Fiber	2	\$8.25
C9082		84-99 3 13/16" Head Gasket .043" Copper	2	\$40.89
C9617		84-99 3 13/16" Base Gasket .020" Fiber	2	\$4.14
C9609		84-99 4" Head Gasket .043" copper w / Axtell Cyl.	2	\$40.89
C9621		84-99 4" Base Gasket w / S&S Cyl. .020" Fiber	2	\$8.25
<b>• EVO Cam Service Kits</b>				
C9623		1970-92 All Big Twins	Kit	\$23.68
C9624F		1993-99 All Big Twins	Kit	\$19.12
<b>• Cam Housing Gaskets</b>				
C9328F5	25225-93	93-99 Cam Cover Gasket AFM	5	\$34.51
C9302F5	25225-70B	84-92 Cam Cover Gasket AFM	5	\$30.47
C9306F	32591-80	84-99 Point Cover Gasket	10	\$11.46
C9350	83162-51DL	84-99 Point Seal double lip	5	\$19.12







**Gaskets for Harley-Davidson®**



Cometic Gasket - An Exclusive NASCAR Performance® Product

## Complete • Top End • Rocker Box Kits & Individual Replacement Parts

Cometic Part #	OEM Part #	Description	Pkg. Qty.	Price
<b>• Intake and Exhaust</b>				
C10035	54-0505	Edlebrock rectangle port intake seal Pair	2	\$3.21
C9227		50mm Carb. to Manifold Seal 1999-UP	1	\$5.03
C9131		All EVO Intake Manifold Seal Kit, Head to Manifold and Carb Seal	Kit	\$10.29
C9088	27002-89	89 to Present Carb to Manifold Sealing Ring	1	\$6.78
C9299	29242-83	84-89 Intake to Head Compliance Fitting Gasket	10	\$13.64
C9290	26995-86A	90-99 Intake to Head Compliance Fitting Gasket	10	\$20.47
C9540	01-931	Extreme Performance Exhaust Gasket	10	\$76.80
C9719	65324-83	84-91 Exhaust Port Gasket Race Style	10	\$41.63
C9288	65324-83A	92-99 Exhaust Port Gasket Taper Style	5	\$49.24
C9247		Exhaust Gasket All Models 99 -UP Race Style .240" thick	10	\$59.62
C9223		S&S Big Bore Manifold to Head Seal	4	\$19.12
<b>• Oil Pump Gaskets and Seals</b>				
C10028		81-91 Oil Pump Rebuild Kit	1	\$5.32
C9168		92-99 Oil Pump Rebuild Kit	1	\$20.00
C9435	11105	84-99 Oil Pump Cap O-ring	25	\$4.68
C9684	11241	92-99 Oil Pump Cover O-ring	25	\$2.64
C9349	26227-58	84-99 Oil Pump Drive Gear Seal	5	\$12.29
C9383	26273-92	92-99 Oil Pump Body Gasket paper	10	\$9.54
C9381	26273-80B	84-91 Oil Pump Body Gasket paper	10	\$9.54
C9382	26276-80A	84-91 Oil Pump Cover Gasket paper	10	\$8.19
C9384	26276-92	92-99 Oil Pump Cover Gasket paper	10	\$9.54
C10011	63528-92	HD Oil Line Ferrule 92-98 ALL	5	\$16.60
<b>• Misc. O-ring and Seal</b>				
C9438	11170	95-99 Crankshaft Postion Sensor O-ring	25	\$6.78
C9351	12026B	84-99 Sprocket Shaft Seal	5	\$15.03
<b>• Derby Cover Gaskets and O-rings</b>				
C9183F1	25416-70C	84-98 All B/T 3 Hole	1	\$6.32
C9338F5	25416-70C	70-E84 Derby Cover Gasket , AFM60	5	\$39.08
<b>• Inspection Cover Gaskets</b>				
C9442	25416-84	L84-98 Derby Cover O-ring	10	\$17.73
C9363	31433-84A	84-98 Derby Cover Bolt Washer metal	5	\$6.61
C9303F5	34906-79	80-84 FXR, FLT Primary Inspec. Cover Gasket, AFM60	5	\$33.16
C9305F5	34906-85	85-UP FXR, FLT Primary Inspection Cvr. Gasket, AFM60	5	\$33.16
C9326F5	60567-36	36-64 FL, FLTH, 58-69 XLCH Inspection Cover Gasket, AFM60	5	\$21.17
C9331F5	60567-65C	65-UP Inspec. Cover Gasket Dyna & Softails, AFM60	5	\$23.87
<b>• Inner Primary Gaskets, O-rings</b>				
C9536	11125	70-E82 Inner Primary O-ring	10	\$67.85
C9441	11147	L82-99 Inner Primary O-ring	10	\$23.22
C9518	12018	70-E84 Inner Primary Bearing Seal	5	\$15.03
C9260	12052	L84-99 Inner Primary Bearing Seal double lip	5	\$12.29
C9343	60629-55	55-64 Chain Housing to Motor Gasket	10	\$22.99
<b>• Starter Housing Gaskets, O-rings</b>				
C9451	11101	L66-82 Starter Oil Deflector O-ring	10	\$4.62
C9433	11116	91-99 Starter Housing O-ring	25	\$6.78
C9436	11171	89-90 Starter Bolt O-ring	10	\$6.78
C9491	12051	L84-88 Starter Shaft Seal	5	\$12.29
C9261	12066	94-99 Starter Shaft Seal	5	\$19.12
C9379	12053	89-93 Starter Shaft Seal	5	\$19.12
C9507F	31320-80	80-86 Starter Housing Gasket	10	\$6.78
C9508F	31321-80	80-86 Starter Cover Gasket	10	\$14.34
C9509	31341-80-DL	80-86 Starter Shaft Seal	5	\$21.82
C9717F	60518-65	65-88 Starter Hole Block Off Gasket	10	\$27.49
C9330F	60559-80	65-85 Starter Housing Gasket	10	\$8.19



# Gaskets for Harley-Davidson®



Cometic Gasket - An Exclusive NASCAR Performance® Product

Cometic Part #	OEM Part #	Description	Pkg. Qty.	Price
----------------	------------	-------------	-----------	-------

**• Shifter Shaft Seals**

C9484	11117	L84-99 FXR,DYNA Shifter Sleeve O-ring	25	\$12.29
C9357	11148	82-E84 Shifter Shaft Quad Seal	10	\$12.29
C9661	11191	90-99 FXST, FLST Shift Lever O-ring	25	\$4.45
C9525	60641-74	74-85 Shifter Shaft Seal	5	\$13.64

**1936 BIG TWIN & EVO INDIVIDUAL REPLACEMENT GASKETS,SEALS, O-RINGS**

**Seals, O-rings and Washers**

C9498	6007	80-98 Drain Plug Washer	10	\$8.66
C9435	11105	90-99 Drain Plug O-ring	10	\$4.68
C9529	11115	65-86 Counter Shaft O-ring	10	\$8.19
C9459	11132	90-99 Dipstick Cover O-ring upper	25	\$4.04
C9667	11140	96-99 Speedometer Sensor O-ring	25	\$4.04
C9495	11162	L84-86 Mainshaft O-ring right end	25	\$6.78
C9361	11165	L84-99 Mainshaft Quad Seal	10	\$13.64
C9530	11166	84-86 Mainshaft Bearing O-ring	25	\$8.19
C9263	11178	87-98 Filler Plug O-ring	10	\$5.44
C9447	11179	87-99 Clutch Cable O-ring	25	\$4.04
C9531	12010	L79-86 Shifter Shaft Seal	5	\$12.29
C9493	12013A	L81-86 Main Drive Gear Seal	5	\$11.52
C9494	12014	65-E84 Clutch Hub Nut Seal	5	\$8.19
C9518	12018	71-E84 Inner Primary Clutch Seal	5	\$15.03
C9506	12022	L66-E81 Main Drive Gear Seal	5	\$11.52
C9351	12026B	70-98 Mainshaft Seal, Engine	5	\$15.03
C9258	12035A	91-99 Main Drive Gear Seal, Transmission	5	\$9.54
C9528	12043	80-86 Starter Shaft Seal	5	\$10.88
C9527	12044DL	80-E84 Main Drive Gear Seal	1	\$8.19
C9259	12045DL	80-06 Shifter Shaft Seal	5	\$12.29
C9359	12050	L84-94 Main Shaft Seal	1	\$5.44
C9260	12052DL	L84-99 Inner Primary Clutch Seal	5	\$12.29
C9262	12067A	95-99 Mainshaft Seal	1	\$6.78
C9632	12068	99-UP Twin Cam, 04-UP Sportster Engine Main Shaft Seal	5	\$31.88
C9497	33043-80	65-95 Neutral Indicator Washer	10	\$8.66
C9374	33076-37	37-86 Starter Crank Seal	10	\$12.29
C9519	34036-36	36-E79 Cam Shaft Seal rubber	10	\$6.78
C9510	34036-80	80-86 Shift Fork Shaft O-ring	10	\$6.78
C9523	35230-39DL	36-79 Mainshaft Seal	5	\$21.82
C9411	35231-36	36-E77 Mainshaft Oil Seal cork washer	10	\$8.19
C9496	37091-80	80-86 Filler Plug Washer	10	\$18.07
C9354	37101-84	84-86 Clutch Release Lever O-ring	1	\$2.69
C9513	37741-67A	L79-81 Mainshaft Seal Double Lip	5	\$27.31
C9514	37741-82DL	82-86 Main Drive Gear Seal Double Lip	5	\$31.40
C9485	62672-90	91-98 Dipstick Cover O-ring	10	\$6.78
C9460	62673-90	91-98 Dipstick O-ring	10	\$4.04
C9403	62702-52	36-86 Drain Plug Washer	10	\$12.29





## Complete Transmission Kits & Individual Gaskets

**Cometic Part #-C9459**  
Trans/Clutch Oil Dipstick  
O-Ring, All Big Twin  
Replaces: 11132

**Cometic Part #-C9460**  
Oil Dipstick O-Ring  
Dyna 91-05  
Replaces: 62673-90

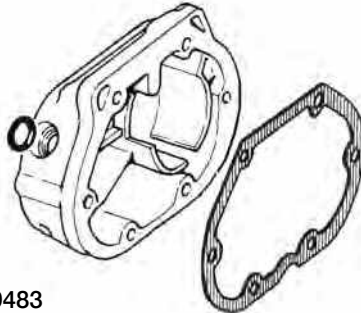

**Cometic Part #-C9483**  
Clutch Release Cover  
All Big Twin 88-06  
Replaces: 36801-87B

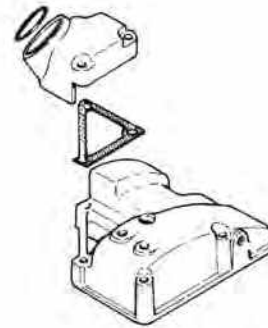

**Cometic Part #-C94891F5**  
Oil Tank Spout  
Dyna 91-05  
Replaces: 62423-90

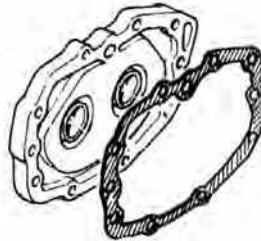

**Cometic Part #-C9264**  
Trans Bearing Cover  
All Big Twin 86-98  
Replaces: 35652-79B  
**Cometic Part #-C9644**  
Trans Bearing Cover  
All Big Twin 99-06  
Replaces: 35653-98

**Cometic Part #-C9459**  
Oil Tank Filler Cap O-Ring  
Top, Dyna 91-98  
Replaces: 11132

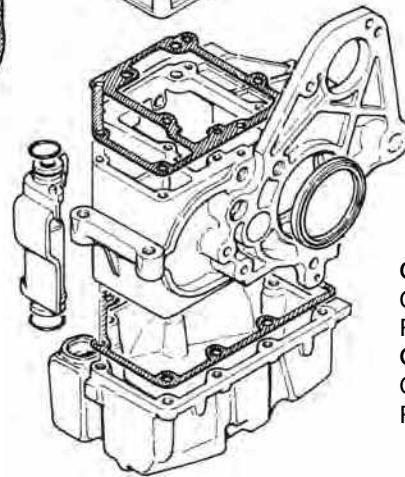

**Cometic Part #-C9488**  
Trans Top Cover  
Dyna 91-98  
Replaces: 34917-90A

**Cometic Part #-C9262**  
Trans Main Drive Seal  
Big Twin L94-06  
Replaces: 12067A

**Cometic Part #-C9485**  
Oil Tank Filler Cap O-Ring  
Bottom, Dyna 91-98  
Replaces: 62672-90

**Cometic Part #-C9646**  
Oil Pan, Dyna 99-UP  
Replaces: 26072-99  
**Cometic Part #-C9490**  
Oil Pan, Dyna 91-98  
Replaces: 26072-90A

Cometic Part #	OEM Part #	Description	Price
----------------	------------	-------------	-------

### 1970-UP BIG TWIN EVO & TWIN CAM INDIVIDUAL REPLACEMENT GASKETS,SEALS, O-RINGS

#### •Complete Transmission Kits

C9464	33031-70	E70-E 79 Big Twin	\$54.45
C9464F	33031-70	E70-E 79 Big Twin EST Kit	\$33.80
C9465	33031-80	L79-82 Big Twin 4 Speed	\$50.93
C9466	33031-82	80-E84 Big Twin 5 Speed	\$65.32
C9467	33031-85	L84-92 Big Twin Except Dyna 5 Speeds	\$77.50
C9468	33031-91	91-99 Dyna & FXDB-S Evolution Models	\$42.22
C9469	33031-93	93-99 FLT,FLH, FXR, Dyna & Softails Evolution Models w/Fiber	\$61.23
C9469F	33031-93	93-99 FLT,FLH, FXR, Dyna & Softails Evolution Models w/AFM	\$61.23
C9639	26072-99	99-06 FLT, FLH, Softail 00-06, Twin Cam Models w/Fiber	\$35.50
C9639F	26072-99	99-06 FLT, FLH, Softail 00-06, Twin Cam Models w/AFM	\$30.71
C9640	26072-99	99-05 Dyna Twin Cam Models	\$35.50
C9151	26072-99	06-17 Dyna Twin Cam 6 Speed Trans Kit	\$56.32
C9174	26072-99	07-17 Softail Models Twin Cam 6 Speed Trans Kit	\$77.50
C9175	26072-99	07-16 FL Models Twin Cam 6 Speed Trans Kit	\$77.50

(Kit contains all of the necessary gaskets, seals, o-rings, end cover, top cover gaskets and all washers needed to completely rebuild the transmission)



# Gaskets for Harley-Davidson®



Cometic Gasket - An Exclusive NASCAR Performance® Product

## Complete Transmission Kits & Individual Gaskets

Cometic Part #	OEM Part #	Description	Pkg. Qty.	Price
----------------	------------	-------------	-----------	-------

### 1936-UP BIG TWIN EVO & TWIN CAM INDIVIDUAL REPLACEMENT GASKETS,SEALS, O-RINGS

#### • Transmission Gaskets

C9434	11201	T/C Mainshaft 5th Gear O-ring 07-14	10	\$8.19
C9642	11290	Twin Cam Neutral Ind. Switch O-ring All Models 1999 -14	10	\$12.34
C9215	12074	T/C Mainshaft Oil Seal 07-14 All, 06-14 Dyna	1	\$10.41
C9200	12077	06 DYNA, All 07-17 Oil Seal Output Gear End Seal	10	\$69.60
C9490F	26072-90	90-98 Oil Pan Gasket Dyna	10	\$43.68
C9646F	26072-99	T/C DYNA Oil Pan Gasket 1999-17	10	\$95.10
C9265F	26077-93	93-98 Oil Pan Gasket FLT	5	\$47.56
C9647F	26077-99	T/C Oil Pan Gasket FLT's 1999-16	10	\$95.10
C9517F	33196-79	L79-86 Shifter Cover Gasket	10	\$8.19
C9515-032AFM33295-36	36-86	End Cover Gasket	10	\$38.42
C9520F	34552-52	52-E79 Ratchet Cover Gasket	10	\$15.03
C9521F	34565-52	52-E79 Shifter Adapter Plate Gasket	10	\$6.78
C9522F	34824-36	36-E79 Top Cover Gasket	10	\$9.54
C9516-032AFM34824-79	L79-86	Top Cover Gasket	10	\$6.78
C9499F	34904-79	80-86 Top Cover Gasket	10	\$30.12
C9983F	34904-86B	87-99 Top Cover Gasket Thin Version	10	\$24.45
C9267	34904-86XC	T/C Trans Cover Gasket All Models 1999 -14 Wide Version	10	\$24.04
C9488F	34917-90A	90-98 Top Cover Gasket Dyna	10	\$35.01
C9645F	34917-99	T/C DYNA Trans. Top Cover Gasket 1999-05	10	\$24.04
C9189	34917-06	T/C Trans. Top Cover Gasket 07-17 All Models	10	\$23.99
C9190F5	35607-06	Trans to Eng. Case Gasket Dyna 06-17 & FL 07-16 Models	1	\$84.36
C9264F	35652-79A	80-98 Bearing Housing Gasket	10	\$32.22
C9644F	35653-98	T/C Bearing Housing Gasket All Models 1999 -06, 99-05 Dyna	10	\$26.68
C9187	35654-06	T/C Bearing Housing Gasket All Models 07 -16	10	\$26.68
C9526F	36801-79	80-86 End Cover Gasket	10	\$17.95
C9483F	36801-87B	87-05 Dyna, 87-06 All Models Clutch Release Gasket	10	\$25.74
C9188	36805-06	T/C Trans End Cover All Models 07-17	10	\$25.74
C9489F	62423-90	91-98 Dyna Oil Filler Spout Gasket	10	\$12.29
C9266F	62432-93	93-06 FLT Oil Filler Spout Gasket	10	\$47.56
C9512F	67141-36	36-83 Speedometer Drive Gasket	10	\$6.78

#### • Carburetor Gaskets

C9452	11107	66-71 XL, 67-70 Big Twin Tillotson Spacer O-ring	10	\$10.88
C9088	27002-89	88-98 XL, 90-99 Big Twin Keihin CV Seal Ring	1	\$6.78
C9417	27023-71	72- E76, 79-85 XL; 71-75 Big Twin Bendix Manifold Gasket	10	\$6.32
C9425	27077-78	78-89 Big Twin Keihin Manifold Gasket	10	\$6.78
C9300	29058-77	L76-87 XL, 76-89 Big Twin Keihin Air Cleaner Gasket	10	\$9.25
C9301	29059-88	88-98 XL, 90-99 Big Twin Keihin CV Air Cleaner Gasket	20	\$17.19







# Gaskets for Harley-Davidson®



Cometic Gasket - An Exclusive NASCAR Performance® Product

## Shovelhead & Panhead®

Cometic Part #-C9365  
Oil Line Sleeve Seal  
1963-84  
Replaces: 63529-57

Cometic Part #-C9986  
Rocker Cover Viton Coated Embossed  
Shovelhead 1966-84

Cometic Part #-C9336  
Rocker Cover 1966-84  
Replaces: 17540-69

Cometic Part #-C9451  
Upper Pushrod Cover  
O-Ring Late 1979-81  
Replaces: 11101

Cometic Part #-C9711  
Upper Pushrod Cover  
O-Ring Late 1981-84  
Replaces: 11118

Cometic Part #-C9998  
Valve Stem Seal 1980-84  
Replaces: 18000-81

Cometic Part #-C9459  
Middle Pushrod Cover  
O-Ring Late 1979-84  
Replaces: 11132

Cometic Part #-C9451  
Rocker Shaft O-Ring  
1966-84  
Replaces: 11101

Cometic Part #-C9346  
Rocker Cover Felt Pad  
1948-65  
Replaces: 17507-48

Cometic Part #-C9342  
Rocker Cover 1948-65  
Replaces: 17541-48A

Cometic Part #-C9604  
Std. Bore Shovelhead  
.043" Fire Ring Head  
Replaces: 16770-66X

Cometic Part #-C9984  
"MLS" Std. Bore  
74 & 80 Shovelhead All  
Models .040" Head

Cometic Part #-C9598  
Pushrod Cover (Small)  
1948-65  
Replaces: 17955-36

Cometic Part #-C9460  
Lower Pushrod Cover  
O-Ring 1979-81  
Replaces: 11133

Cometic Part #-C9461  
Lower Pushrod Cover  
O-Ring Late 1981-84  
Replaces: 11133A

Cometic Part #-C9613  
Head 1948-65  
Replaces: 16770-48X

Cometic Part #-C9567  
Pan/Shovel Front Cylinder Base  
Gasket .031" (Fiber) 1948-84  
Replaces: 16776-48

Cometic Part #-C9987  
Shovel Front & Rear Pair  
Std. 74 & 80 Cylinders  
Viton Coated Embossed Base  
Gasket

Cometic Part #-C9297  
Rear Tappet Block  
1948-84  
Replaces: 18633-48D

Cometic Part #-C9606  
Pushrod Cover (Large)  
1948-E79  
Replaces: 17955-48

Cometic Part #-C9568  
Pan/Shovel Rear Cylinder Base  
Gasket .031" (Fiber) 1948-84  
Replaces: 16777-48

Cometic Part #-C9298  
Front Tappet Block  
1948-84  
Replaces: 18634-48C



# Gaskets for Harley-Davidson®



Cometic Gasket - An Exclusive NASCAR Performance® Product

## Complete • Top End • Rocker Box Kits & Individual Replacement Parts

Cometic Part #	OEM Part #	Description	Price
<b>EST MOTOR KITS FOR SHOVELHEAD &amp; PANHEAD MOTORS</b>			
<b>• Complete EST Gasket Kits for Shovelhead/Panhead</b>			
C9900	17029-66	1966-69 74" Shovelhead FL, FLH	\$172.59
C9964	17029-70A	1970-84 74" & 80" Shovelhead 4 Spd	\$146.40
C9154		1970-84 3 5/8" Shovelhead 4 Spd	\$190.49
C9965	17029-80	1980-84 80" Shovelhead 5 Spd. FLT	\$211.03
C9966	17028-48	1948-65 Panhead FL, FLH	\$146.40

### Motor Only Shovelhead Gasket Kits

C10091		1970-84 STD Bore Engine Only Gasket & Seal Kit NEW!	\$108.15
--------	--	---	----------

### • Top End EST Gasket Kits for Shovelhead/Panhead

C9967	17034-66X	1966-84 74" & 80" Shovelhead 4 or 5 Spd	\$103.11
C9968	17034-48	1948-65 Panhead FL, FLH	\$103.11

### • Big Bore Shovelhead Top End Gasket Kits

C9918		3 5/8" Bore 1966-84 All Models	\$103.11
C9969		3 13/16" Bore 1966-84 All Models, No Oil Drains in Head Gasket	\$103.11

EST Kits contain MLS head gaskets, steel viton coated base gaskets and AFM material

Cometic Part #	OEM Part #	Description	Pkg. Qty.	Price
----------------	------------	-------------	-----------	-------

## 1936-84 BIG TWIN PAN & SHOVEL INDIVIDUAL REPLACEMENT GASKETS,SEALS, O-RINGS

### • Rocker Housing Gaskets and O-rings

C10030	17535-38	36-47 Knucklehead Frt Rocker Tin Gasket, .031" Fiber	10	\$40.49
C10031	18265-37	36-47 Knucklehead Valve Guide Gasket	10	\$22.07
C10008	17540-69	66-84 Rocker Cover Gasket .043" CFM20	2	\$21.82
C9986	17540-69	66-84 Rocker Cover Gasket .020" Viton Coated Emb. Steel	2	\$21.82
C9336	17540-69	66-84 Rocker Cover Gasket .031" Fiber	10	\$19.35
C9342	17541-48A	48-65 Rocker Cover Gasket .031" Fiber	10	\$45.86
C9346	17507-48	48-65 Rocker Cover Felt Pad	10	\$23.22
C9451	11101	66-84 Rocker Shaft O-ring	25	\$4.62
C9424	18000-81	L81-84 Valve Guide Seal Teflon	25	\$46.61
C9419	18196-51	51-29 Valve Guide Gasket	20	\$11.46
C9998		Late Shovelhead & .625" O.D. Guides Viton Seal with garter	20	\$49.60

### • Pushrod O-rings and Tappet Block Gaskets

C9598	17955-36	36-E79 Push Rod Cover small cork	25	\$9.01
C9606	17955-48	48-E79 PushRod Cover Large cork	25	\$8.19
C9451	11101	L79-E81 Push Rod Cover O-ring Upper	10	\$4.62
C9459	11132	L79-84 Push Rod Cover O-ring Middle	25	\$4.04
C9460	11133	L79-E81 Push Rod Cover O-ring Lower	5	\$4.04
C9711	11118	L81-84 Push Rod Cover O-ring Upper	25	\$20.53
C9461	11133	L79-E81 Push Rod Cover Quad Seal Lower	10	\$9.54
C9297	18633-48D	48-84 Rear Tappet Block Gasket .020" Fiber	10	\$6.78
C9298	18634-48C	48-84 Front Tappet Block Gasket .020" Fiber	10	\$8.19
C9216		66-78 All Shovel Push Rod Tube Seal Set	Kit	\$6.04
C9584		L79-E81 All Shovel Push Rod Tube Seal Set	Kit	\$4.79
C9585		L81-84 All Shovel Push Rod Tube Seal Set	Kit	\$6.04

### • Head and Base Gaskets

C9984	16770-66X	66-84 Shovelhead MLS Stock Bore Head Gasket 74" & 80" .040"	2	\$46.34
C9985		66-84 Shovelhead MLS 3 5/8 BB Head Gasket .040"	2	\$46.34
C9206		Shovel Only Base Gasket Std bore .020" Viton FR & RR Pair	2	\$24.57
C9207		3 5/8" Shovel Only Base Gasket Std bore .020" Viton 2 Fronts	2	\$24.57
C9987		48-65 Panhead Base Front & Rear .020" Viton	2	\$24.57
C9988		48-65 Panhead Base 3 5/8" Front & Rear .020" Viton	2	\$24.57
C9989		48-65 Panhead Base 3 5/8" 2 Fronts for S&S Cylinders Viton	2	\$24.57
C9714		66-84 Shovelhead Stock Bore Head Gasket; .032" Copper	2	\$20.41





Gaskets for Harley-Davidson®



Cometic Gasket - An Exclusive NASCAR Performance® Product

## Complete • Top End • Rocker Box Kits & Individual Replacement Parts

Cometic Part #	OEM Part #	Description	Pkg. Qty.	Price
<b>• Head and Base Gaskets</b>				
C9713		66-84 Shovelhead 3 5/8" Copper Head Gasket: .032"	2	\$20.41
C9618		66-84 Pan/Shovel 3 5/8" Base Gasket: .031" Fiber	2	\$8.25
C9893		66-84 Pan/Shovel 3 13/16" Base Gasket: .020" RC Metal	2	\$21.12
C9567	16776-48	48-84 Pan/Shovel Front Cyl. Std. Bore base Gasket; .031" Fiber	10	\$21.53
C9568	16777-48	48-84 Pan/Shovel Rear Cyl. Std. Bore base Gasket; .031" Fiber	10	\$21.53
C9137	16770-48MLS	48-65 Panhead .040" MLS Head Gasket Pair	2	\$46.34
<b>• Cam / Gear Housing Gaskets and Seals</b>				
C9334F5	25225-36C	41-69 Gear Cover Gasket, AFM60	5	\$57.08
C9302F5	25225-70B	70-84 Cam Cover Gasket, AFM60	5	\$30.47
C9323	32591-70	70-79 Points Cover Gasket	10	\$11.52
C9306	32591-80	80-84 Points Cover Gasket	10	\$11.46
C9350	83162-51DL	70-84 Cam Cover Seal / Double Lip	5	\$19.12
C9337	32521-36	36-64 Timer Base Gasket	10	\$5.44
<b>• Intake and Exhaust Gaskets</b>				
C9453	27060-55	55-E78 Manifold to Head O-ring	10	\$6.78
C9608	27062-78	L78-84 Intake Seal Manifold to Head Rubber Band	10	\$20.36
C9587	65834-68X	66-84 Exhaust Gasket with Fire Ring	10	\$33.64
<b>• Oil Pump and Related Gaskets / Seals</b>				
C9435	1105	L70-84 Oil Screen Pump Plug O-ring	10	\$4.68
C9349	26227-58	68-84 Oil Pump Seal	5	\$12.29
C9715	26231-78	54-80 Oil Pump Relief Plug Gasket	10	\$13.64
C9397	26244-37	37-59 Oil Pump Body Gasket	10	\$9.25
C9393	26245-41	41-67 Oil Pump Gasket Fiber	10	\$8.59
C9391	26246-68D	68-E80 Oil Pump Body Fiber	10	\$8.19
C9394	26257-50A	L50-67 Oil Pump Cover Fiber	10	\$8.19
C9392	26258-68D	68-E80 Oil Pump Cover Gasket Fiber	10	\$13.64
C9382	26276-80A	L80-84 Oil Pump Cover Gasket Fiber	10	\$8.19
C9403	62702-52	66-E70 Oil Screen Plug Gasket	10	\$12.29
C9365	63529-57	63-84 Oil Line Sleeve Seal	10	\$9.25
C9351	12026A	70-84 Motor Main Shaft Seal	5	\$15.03
<b>• Generator Gaskets / Seals</b>				
C9322	30143-30	36-57 Gen. Gasket	10	\$10.88
C9321F	30143-58	58-69 Gen. Gasket	5	\$5.44



WARNING: Cancer and Reproductive Harm www.P65Warnings.ca.gov



# Gaskets for Harley-Davidson®



Cometic Gasket - An Exclusive NASCAR Performance® Product

## Evolution Sportster®

**Cometic Part #-C9294**  
Pushrod Tube O-Ring  
Upper 1991-03  
Replaces: 11190

**Cometic Part #-C9481**  
Umbrella Valve Seal  
1991-03  
Replaces: 26856-89

**Cometic Part #-C9286**  
Rocker Cover Washer  
1987-03  
Replaces: 63858-49

**Cometic Part #-C9276**  
Upper Rocker Box  
1991-03  
Replaces: 17354-89

**Cometic Part #-C9280**  
Lower Rocker Box  
1991-02  
Replaces: 17353-89A

**Cometic Part #-C9283**  
Center Rocker Box  
Replaces: 17358-84A

**Cometic Part #-C9865**  
One Piece Rocker Base  
1986-19  
Replaces: 16778-97X &  
16779-97X

**Cometic Part #-C9836**  
Viton Valve Stem Seal  
1986-02  
Replaces: 18001-83A

**Cometic Part #-C9290**  
Intake Manifold to  
Head Seal  
Replaces: 26995-86B

**Cometic Part #-C9688**  
Std. Bore Head .040" MLS  
1200 1986-19

**Cometic Part #-C9689**  
Std. Bore Head .030" MLS  
1200 1986-19

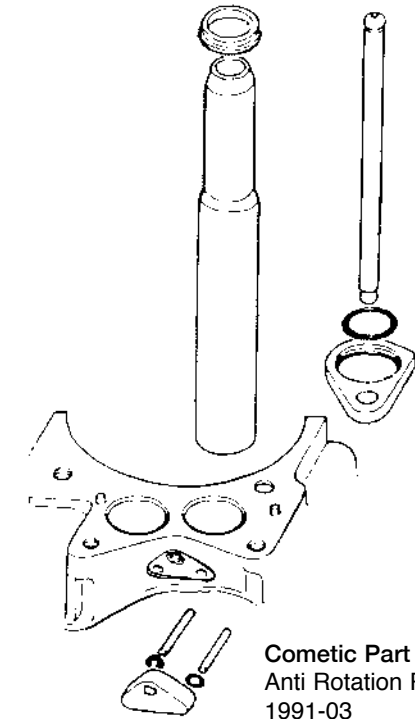

**Cometic Part #-C9296**  
Anti Rotation Pin O-Ring  
1991-03  
Replaces: 11176

**Cometic Part #-C9295**  
Pushrod Tube O-Ring  
Lower 1991-03  
Replaces: 17944-89

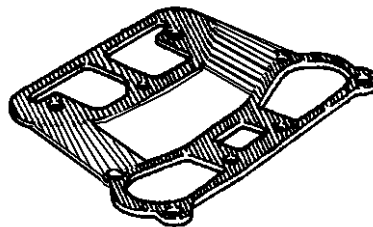
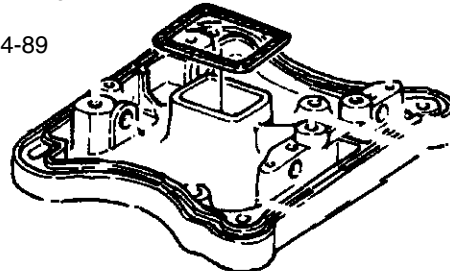
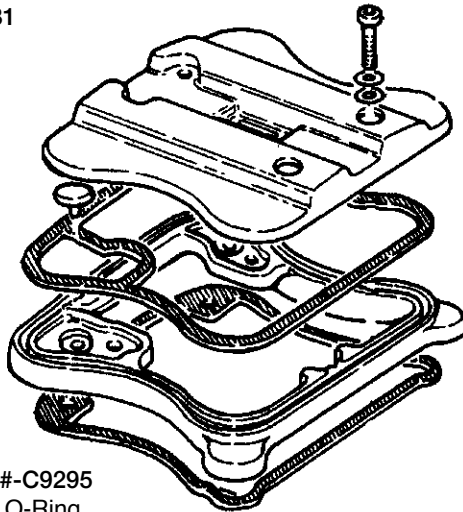

**Cometic Part #-C9355**  
Cam Seal 1986-03  
Replaces: 11124-DL

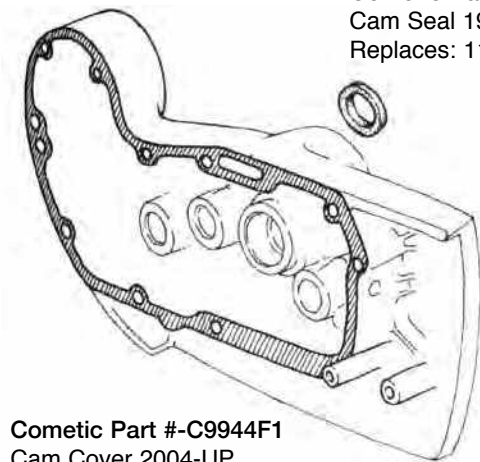

**Cometic Part #-C9944F1**  
Cam Cover 2004-UP  
Replaces: 25263-90D AFM  
**Cometic Part #-C9313F1**  
Cam Cover 1991-03  
Replaces: 25263-90B AFM  
**Cometic Part #-C9311F1**  
Cam Cover 1986-90  
Replaces: 25263-86 AFM

**Cometic Part #-C9719**  
Race Style Exhaust  
Replaces: 65324-83

**Cometic Part #-C9288**  
Std. Exhaust  
Replaces: 65324-83

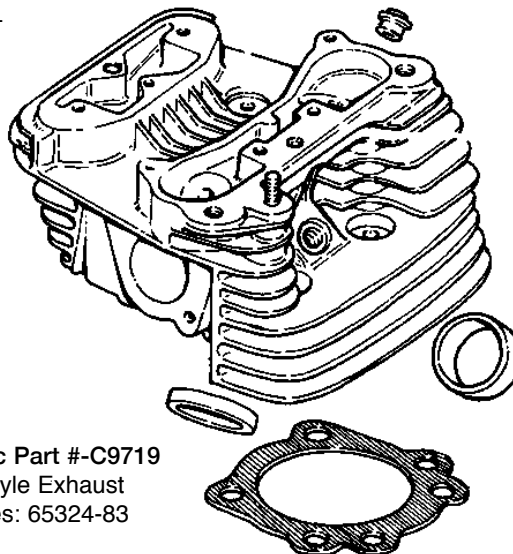





Gaskets for Harley-Davidson®



Cometic Gasket - An Exclusive NASCAR Performance® Product

Complete • Top End • Rocker Box Kits & Individual Replacement Parts

Cometic Part #	Description	Price
<b>EST BUELL FIREBOLT and BLAST</b>		
<b>• Top End and Complete Motor Rebuild Gasket Kits</b>		
C9204	Buell Firebolt Top End Rebuild Kit Std. Bore 04-06	\$109.37
C9856	Buell Firebolt Top End Rebuild Kit Std. Bore 00-03	\$109.37
C9857	Buell Firebolt Complete Motor Rebuild Kit Std. Bore 02-03	\$155.28
C9863	Buell Blast Big Bore Top End Rebuild 3 13/16"	\$86.67
C9863-STD	Buell Blast Big Bore Top End Rebuild STD Bore	\$86.67
C9864	Buell Blast Big Bore Complete Motor Kit 3 13/16"	\$128.74
C9864-STD	Buell Blast Big Bore Complete Motor Kit STD Bore	\$128.74
<b>• Rocker Box Rebuild Kit</b>		
C9213	Buell XB 9/12 98-02	\$49.19
<b>EST EVO SPORTSTER MOTOR GASKET KITS</b>		
<b>• Complete Gasket Kits</b>		
C9754F	86-90 883 EVO Sportster	\$186.29
C9755F	91-03 883 EVO Sportster	\$198.98
C9193	04-06 883 EVO Sportster	\$223.37
C9191	07-19 883 EVO Sportster	\$223.37
C9756F	86-87 1100 EVO Sportster	\$155.28
C9757F	88-90 1200 EVO Sportster	\$204.12
C9758F	91-03 1200 EVO Sportster	\$215.82
C9855F	91-03 1200 EVO Sportster W / .030" Head Gasket	\$155.28
C9133	91-03 1200 EVO Sportster 3 13/16" Big Bore w/.040" Head Gasket	\$155.28
C9124	91-03 1200 EVO Sportster 3 13/16" Big Bore W / .030" Head Gasket	\$155.28
C9952	04-06 1200 EVO Sportster	\$155.28
C9953	04-06 1200 EVO Sportster W / .030" Head Gasket	\$155.28
C9176	07-19 1200 EVO Sportster	\$223.37
<b>• Top End Gasket Kits</b>		
C9759	86-90 883 EVO Sportster	\$109.37
C9760	91-03 883 EVO Sportster	\$109.37
C9194	04-06 883 EVO Sportster	\$176.57
C9192	07-19 883 EVO Sportster	\$176.57
C9761	86-87 1100 EVO Sportster	\$109.37
C9762	88-90 1200 EVO Sportster	\$109.37
C9907	88-90 1200 EVO Sportster W / .030" Head Gasket	\$109.37
C9763	91-03 1200 EVO Sportster	\$109.37
C9854F	91-03 1200 EVO Sportster W / .030" Head Gasket	\$109.37
C9970	04-06 1200 EVO Sportster	\$109.37
C9971	04-06 1200 EVO Sportster W / .030" Head Gasket	\$109.37
C9177	07-19 1200 EVO Sportster	\$109.37
<b>• Big Bore Top End Gasket Kits</b>		
C10096	3.570" Top end kit w/.030" MLS Head Gasket 1991-03	\$109.37
C10095	3.570" Top end kit w/.030" MLS Head Gasket 2004-06	\$109.37
C10094	3.570" Top end kit w/.030" MLS Head Gasket 2007-19	\$109.37
C10048	3.562" Bore; 91-03 EVO Sportster W / .040" MLS Head Gasket	\$109.37
C10050	3.5/8" Bore; 91-03 EVO Sportster W / .027" MLS Head Gasket	\$109.37
C10050-040	3.5/8" Bore; 91-03 EVO Sportster W / .040" MLS Head Gasket	\$109.37
C9772	3 3/4" Bore; 86-90 883 EVO Sportster	\$109.37
C9773	3 3/4" Bore; 91-UP 883 EVO Sportster	\$114.45
C9774	3 3/4" Bore; 86-87 1100 EVO Sportster	\$109.37
C9775	3 3/4" Bore; 88-90 1200 EVO Sportster	\$109.37
C9776	3 3/4" Bore; 91-03 1200 EVO Sportster	\$215.64
C9138	3 13/16" Bore; 91-03 1200 EVO Sportster W / .040" MLS Head Gasket	\$109.37
C9141	3 13/16" Bore; 91-03 1200 EVO Sportster W / .030" MLS Head Gasket	\$109.37
C9219	3 13/16" Bore; 04-06 1200 EVO Sportster W / .040" MLS Head Gasket	\$109.37



Complete • Top End • Rocker Box Kits & Individual Replacement Parts

Table with 5 columns: Cometic Part #, OEM Part #, Description, Pkg. Qty., Price. Includes 'Rocker Box Rebuild Gasket Kit' items.

EVO SPORTSTER INDIVIDUAL REPLACEMENT GASKETS,SEALS, O-RINGS

• Rocker Cover Gaskets

Table with 5 columns: Cometic Part #, OEM Part #, Description, Pkg. Qty., Price. Lists various rocker cover gaskets and seals.

2004 SPORTSTER ROCKER BOXES ARE TWO PIECE AND DO NOT USE AN UPPER ROCKER RUBBER GASKET

• Head and Base Gaskets

Table with 5 columns: Cometic Part #, OEM Part #, Description, Pkg. Qty., Price. Lists various head and base gaskets.





Gaskets for Harley-Davidson®



Cometic Gasket - An Exclusive NASCAR Performance® Product

# Complete • Top End • Rocker Box Kits & Individual Replacement Parts

Cometic Part #	OEM Part #	Description	Pkg. Qty.	Price
<b>• Pushrod O-Ring Kit</b>				
C9143	91-03	Sportster Pushrod O-ring Kit	KIT	\$14.32
<b>• Pushrod and Tappet Block Gaskets and O-rings</b>				
C9955	17976	2004-19 Tappet block gasket	2	\$16.26
C9956	11377	2004-19 Lower pushrod tube O-ring	25	\$65.81
C9459	11132	86-90 Pushrod Tube O-ring Middle	25	\$4.04
C9293	11145	86-90 Pushrod Tube O-ring Lower	25	\$8.19
C9292	111157	86-90 Pushrod Tube O-ring Upper	25	\$20.94
C9448	11110	86-90 Tappet Screw O-ring	10	\$5.44
C9443	11167	86-90 Tappet Block O-ring Upper	25	\$10.88
C9444	11168	86-90 Tappet Block O-ring Lower	10	\$10.88
C9294	11190	91-19 Pushrod Tube O-ring Upper	10	\$10.48
C9295	17944-89	91-99 Pushrod Tube O-ring Lower	10	\$18.19
C9296	11176	91-99 Tappet Pin Cover O-ring - Anti Rotation Pin	10	\$1.06
<b>• Intake and Exhaust Gaskets</b>				
C9290	26995-86A	86-19 Intake Manifold to Head / Seal	10	\$20.47
C9088	27002-89	84-04 Intake Seal to Carb	1	\$6.78
C9719	65324-83	84-19 Exhaust Port Gasket Race Style	10	\$41.63
C9288	65324-83A	84-19 Exhaust Port Gasket Tapered Style	10	\$49.24
C9540		84-19 All Models Exhaust Extreme Performance	10	\$76.80
C9223		S&S Big Bore Manifold to Head Seal	4	\$19.12
<b>• Cam Cover Gaskets</b>				
C9355	11124-DL	86-99 Points Cover Seal Double Lip	5	\$10.59
C9306F	32591-80	86-99 Points Cover Gasket	10	\$11.46
C9311F5	25263-86	86-90 Cam Cover Gasket	10	\$69.42
C9313F5	25263-90B	91-03 Cam Cover Gasket	5	\$62.47
C9944F5	25263-90D	2004-19 Cam Cover Gasket	5	\$33.16
C10049F1	25262-90D	91-03 Sporty Cam Cover Gasket .060" AFM	1	\$12.52
C10049F5	25262-90D	91-03 Sporty Cam Cover Gasket .060" AFM	5	\$62.47
C10029F1	25279-08	2008-12 XR1200 Cam Cover Gasket	1	\$7.79
C10029F5	25279-08	2008-12 XR1200 Cam Cover Gasket	5	\$33.16
<b>• Primary Cover Gaskets ,Seals</b>				
C9125		2004-19 Sportster Complete Primary Rebuild	Kit	\$31.29
C9211		91-03 Sportster Complete Primary Rebuild	Kit	\$42.11
C9210		86-90 Sportster Complete Primary Rebuild	Kit	\$42.11
C9943F5	34955-04	2004-19 Primary Cover Gasket	5	\$108.31
C9957	34986-04	2004 -19 Chain Inspection Cover Gasket .060" AFM	5	\$23.87
C9435	11105	2004 -19 Primary drain plug O-ring	10	\$4.68
C9436	11171	86-19 Primary Inspection Cover Screw O-ring	10	\$6.78
C9447	11179	88-99 Clutch Cable O-ring	25	\$4.04
C9434	11187	91-93 Clutch Inspection Cover O-ring	10	\$8.19
C9439	11188	91-99 Inspection Cover O-ring	10	\$8.19
C9220	25463-94A	94-19 Clutch Cover O-ring	5	\$36.49
C9363	31433-84A	91-93 Sealing Washer	5	\$6.61
C9401	34624-77	77-90 Footpeg Stud Gasket	10	\$13.21
C9310F5	34955-75	77-90 Primary Cover Gasket, AFM60	5	\$108.31
C9314F5	34955-89A	91-03 Primary Cover Gasket, AFM60	5	\$108.31
C9943F5	34955-04	04-19 Sportster Primary Cover Gasket, AFM60	5	\$108.31
C9354	37101-84	86-UP Shifter Shaft Seal	1	\$2.69
C9353	35151-74	86-99 Motor Sprocket Shaft Seal	5	\$22.23
C9632	12068	2004-19 Motor Sprocket Shaft Seal	5	\$31.88
C9667	11289	2004-19 Crank Position Sensor O-ring	25	\$4.04



WARNING: Cancer and Reproductive Harm www.P65Warnings.ca.gov



## Complete • Top End • Rocker Box Kits & Individual Replacement Parts

Cometic Part #	OEM Part #	Description	Pkg. Qty.	Price
<b>• Oil Pump and Related Gaskets,Seals, and O-rings</b>				
C9376	12036A	86-90 Oil Pump Seal metal	5	\$7.89
C9449	26433-77	86-90 Oil Pump Check Valve O-ring	10	\$9.54
C9439	26434-76A	86-90 Oil Pump O-ring	10	\$8.19
C9437	26434-91	91-19 Oil Pump Cover O-ring	10	\$3.04
C9399F	26495-75	86-90 Oil Pump Gasket	10	\$9.54
C9315F	26495-89B	91-19 Oil Pump Gasket	10	\$8.19
C9961	11120	2004-19 Oil dipstick O-ring	5	\$4.04
C9962		2004-19 Oil jet assembly gasket	6	\$10.94
<b>• Starter and Transmission Gaskets,Seals, and O-rings</b>				
C9312F	31488-81B	86-UP Starter Gasket	10	\$7.89
C9362	12030	91-06 Main Drive Gear Seal	5	\$10.88
C9356	12049-DL	86-90 Transmission M/S Seal	5	\$10.59
C9359	12050	91-94 Transmission M/S Seal	1	\$5.44
C9262	12067A	95-04 Main Drive Gear Seal	1	\$6.78
C9361	11165	91-04 Main Shaft Quad Seal 5th Gear	10	\$13.64
C9460	11113	05-19 Main Shaft O-ring 5th Gear	5	\$4.04
C9215	12074	07-19 Main Shaft Seal	1	\$10.41

## Iron Sportster®

Part #-C9292  
Pushrod Cover O-Ring Upper  
1984-85  
Replaces: 111S7

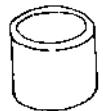

Part #-C9459  
Pushrod Cover O-Ring  
Middle 1979-85  
Replaces: 11132



Part #-C9451  
Lower & Top Pushrod O-Ring 1979-85  
Replaces: 11101

Part #-C9595  
Pushrod Cover Seal  
Lower, Middle, Top Early 1979 XL, XLCH



Part #-C9451  
Rocker Arm Shaft  
O-Ring 1957-85  
Replaces: 11101

Part #-C9602  
Rocker Cover Gasket  
1957-85  
Replaces: 17536-70

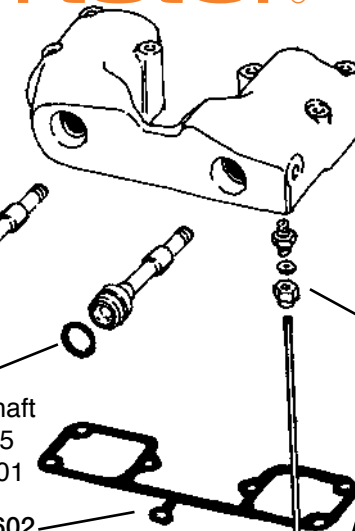

Part #-C9365  
Rubber Sleeve, Oil  
Line 1957-85  
Replaces 63529-57

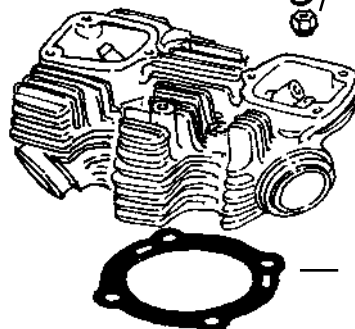

Part #-C9566  
1000cc Head Gasket  
.043" Copper  
Late 1973-85  
Replaces: 16769-82

Illustrations courtesy: Clymer® Publications Clymer.com





# Complete • Top End • Rocker Box Kits & Individual Replacement Parts

Cometic Part #	OEM Part #	Description	Pkg. Qty.	Price
----------------	------------	-------------	-----------	-------

## STANDARD MOTOR KITS FOR 900/1000 SPORTSTER

### • Complete Gasket Kits for 900/1000 Sportster

C9045F	17026-71	1957-71 900 Sportster XL, XLH, XLCH		\$141.77
C9047F	17026-72	1972-E73 1000 Sportster XLH, XLCH		\$121.07
C9049F	17026-73L	1973-76 1000 Sportster XLH, XLCH		\$118.91
C9051F	17026-79	1977-85 1000 Sportster XLH, XLCH, XLS Hi-Compression		\$135.95
C9117F	17026-82	1982-85 1000 Sportster XLH, XL, XLS Low Compression, .063" Head Gaskets		\$126.68

Kit contains .032" copper head gaskets and all of the necessary gaskets, seals and o-rings to rebuild the motor.

Base Gaskets are .031"

### • Top End Gasket Kits for 900/1000 Sportster

C9102	17030-57	1957-71 900 Sportster XL, XLH, XLCH		\$56.32
C9103	17030-72	1972-E73 1000 Sportster XLH, XLCH		\$56.32
C9104	17030-72AL	1973-76 1000 Sportster XLH, XLCH		\$56.32
C9052	17030-72B	1977-85 1000 Sportster XLH, XLCH, XLS Hi-Compression		\$56.32
C9116	17030-82	1982-85 1000 Sportster XLH, XL, XLS Low Compression, .063" Head Gaskets		\$56.32

Kit contains all of the necessary gaskets, seals and o-rings to rebuild the motor from the cylinder base up.

Head Gaskets are .032" copper except where noted and Base Gaskets are .031"

## 1957-85 XL IRONHEAD SPORTSTER INDIVIDUAL REPLACEMENT GASKETS,SEALS, O-RINGS

### • Rocker Cover Gaskets

C9400	6114	86 Rocker Cover Washer copper	10	\$6.78
C9451	11101	57-85 Rocker Arm Shaft O-ring	10	\$4.62

### • Rocker Cover Gaskets,Seals,and O-rings

C9448	11110	83-85 XR1000 Rocker Shaft O-ring	10	\$5.44
C9529	11115	83-85 XR1000 Rocker Arm Shaft O-ring	10	\$8.19
C9602	17536-70	57-85 Rocker Cover Gasket	10	\$10.24
C9365	63529-57	57-85 Rubber Sleeve, Oil Line	10	\$9.25

### • Head and Base Gaskets

C9698	16769-72A	72-E73 1000cc Head Gasket , .020" Copper	10	\$116.79
C9565	16769-73	L73-85 1000cc Head Gasket , .032" Copper	10	\$116.79
C9566	16769-82	L73-85 1000cc Head Gasket , .043" Copper	10	\$83.59
C9699	16774-57	57-71 900cc Cylinder Base Gasket, .012" Fiber	10	\$41.50
C9603	16774-72	72-85 1000cc Cylinder Base Gasket, .031" Fiber	10	\$21.10

### • Pushrod and Tappet Block Gaskets, O-rings

C10068		57-84 All Iron Sportsters Pushrod seal set	Kit	\$10.08
C9459	11132	79-85 Pushrod Cover O-ring (4) middle	25	\$3.92
C9292	11157	84-85 Pushrod Cover O-ring (4) upper	25	\$20.33
C9369	12023	83-85 XR 1000 Pushrod Cover Seal	5	\$14.59
C9598	17955-36	57-E79 Pushrod Cover Seal / cork	25	\$8.75
C9408	17955-36A	57-E79 Pushrod Cover Seal / rubber	100	\$61.10

### • Intake and Exhaust Gaskets

C9608	27062-78	79-85 Intake Manifold to Head O-ring	10	\$19.77
-------	----------	--------------------------------------	----	---------

### • Cam and Timer Compartment Gaskets

C9355	11124DL	71-85 Timer Compartment Seal / double lip	5	\$10.28
C9325	32522-37	57-64 XL, XLH Timer Base Gasket	10	\$10.56
C9316F5	25224-52A	57-81 Cam cover Gasket, XR750	5	\$70.47
C9332	25263-81	82-85 Cam Cover Gasket	10	\$87.36
C9323	32591-70	71-78 Point Cover Gasket	10	\$11.18
C9306	32591-80	80-85 Ignition Cover Gasket	10	\$11.13





# Gaskets for Harley-Davidson®



Cometic Gasket - An Exclusive NASCAR Performance® Product

## Complete • Top End • Rocker Box Kits & Individual Replacement Parts

Cometic Part #	OEM Part #	Description	Pkg. Qty.	Price
<b>• Charging and Starting Gaskets</b>				
C9433	11116	81-85 Starter Housing O-ring	25	\$6.78
C9701	31461-70	70-E79 Starter hole cover plate Gasket	10	\$26.14
C9324	31471-67A	67-80 Starter Housing Gasket	10	\$28.65
C9333	31488-77	67-80 Starter Housing Mount Gasket	10	\$5.44
C9312	31488-81	81-85 Starter Motor Gasket	10	\$7.89
C9702	60645-65	67-80 Solenoid Gasket	10	\$8.08
C9369	12023	68-69 XLCH Magneto Seal	5	\$15.03
C9327	29550-55	58-69 XLCH Magneto Cover Gasket	10	\$13.64
C9374	29603-48	58-E65 Magneto Seal	10	\$12.29
C9321	30143-58	58-E84 Generator Gasket	5	\$5.44
<b>• Oil System Gaskets, O-rings and Seals</b>				
C9376	12036A	77-78 / 83-85 Oil Pump Outer Plate Seal	5	\$7.89
C9404	24978-57	57-76 Oil Strainer Gasket	10	\$6.61
C9349	26227-58	L58-76 Oil Pump Oil Seal	5	\$12.29
C9390	26256-52	57-76 Oil Pump Gasket	10	\$9.54
C9385	26258-52	57-E62, 72-76 Oil Pump Outer Cover Gasket	10	\$12.29
C9389	26258-62	L62-71 Oil Pump Outer Cover Gasket	10	\$12.29
C9388	26259-52	57-E62, 72-76 Oil Pump Inner Cover Gasket	10	\$13.64
C9386	26259-62	L62-71 Oil Pump Inner Cover Gasket	10	\$12.29
C9287	26432-76A	77-85 Oil Pump Body O-ring	10	\$12.29
C9449	26433-77	77-85 Check Valve Oil Pump O-ring	10	\$9.54
C9445	26434-76A	77-85 Oil Pump Cover O-ring	10	\$6.78
C9399	26495-75	77-85 Oil Pump Gasket	10	\$9.54
C9286	63858-49	71-85 Oil Level Screw Gasket	10	\$6.04
<b>• Primary, Clutch, and Transmission Gaskets, Seals, and O-rings</b>				
C9446	11139	L78-85 Primary Filler Cap O-ring	10	\$6.78
C9317F5	34952-52	XR750, 58-69 XLCH Primary Cover Gasket AFM .060"	5	\$96.40
C9318F5	34955-67	67-76 XLH, 70-76 XLCH Primary Cover Gasket AFM .060"	5	\$120.78
C9703	34955-67A	67-76 XLH, 70-76 XLCH Primary Cover Gasket .031"	5	\$138.97
C9326	60567-36	36-64 FL, FLH 58-69 XLCH Inspection/Chain Cover .125" Cork	10	\$40.71
C9326F	60567-36	36-64 FL, FLH 58-69 XLCH Inspection/Chain Cover .125" Cork	5	\$21.17
C9326F1	60567-36	36-64 FL, FLH 58-69 XLCH Inspection/Chain Cover .060" AFM	1	\$4.09
C9326F5	60567-36	36-64 FL, FLH 58-69 XLCH Inspection/Chain Cover .060" AFM	5	\$21.17
C9458	11103	L57-66 XLH, 57-69 XLCH Clutch Gear O-ring	10	\$4.04
C9310F5	34955-75	77-90 Sportster Primary Cover Gasket AFM .060"	5	\$108.31
C9455	11119	67-70 XLH, 70 XLCH Clutch Gear O-ring	25	\$5.44
C9367	12021	67-70 XLH, 70 XLCH Clutch Gear Oil Seal	5	\$15.03
C9364	37339-53	57-70 Release Rod Oil Seal	10	\$9.25
C9368	37531-56B	57-66 XLH, 57-69 XLCH Clutch Gear Seal	5	\$10.59
C9371	37740-57	L57-66 XLH, 57-69 XLCH Clutch Shell Seal	5	\$20.47
C9513	37741-67	67-70 XLH, 70 XLCH Clutch Shell Seal	5	\$27.31
C9319	37762-52	57-70 Clutch Cover Gasket	10	\$45.97
C9374	33076-37	57-79 Kicker Shaft Seal	10	\$12.29
C9370	34035-52	57-85 Shifter Shaft Seal	5	\$10.88
C9401	34624-77	77-85 Left Footrest Stud Boss Gasket	10	\$13.21
C9356	12049DL	L84-85 Transmission Mainshaft Seal	5	\$10.59
C9366	35151-52A	57-E84 Trans Mainshaft Seal, 57-E74 Sprocket Shaft	5	\$13.64
C9353	35151-74	L84-85 Trans Mainshaft Seal, L74-85 Motor Sprocket Shaft	5	\$22.23





# Gaskets for Harley-Davidson®



Cometic Gasket - An Exclusive NASCAR Performance® Product

## Rotax 600 Gaskets

Part #	Description	Price
C9500	Head and Base Only, Long Stroke, 3.860" Bore Supplied with .010 and .020 Copper Base Gasket (4.120" Sleeve Dia)	\$42.47
C9501	Head and Base Only, Long Stroke, 3.908" Bore Supplied with .010 and .020 Copper Base Gasket (4.120" Sleeve Dia)	\$42.47
C9504	.005 Copper Base Gasket	\$12.52
C9502	.010 Copper Base Gasket	\$12.52
C9505	.016 Copper Base Gasket	\$12.52
C9503	.020 Copper Base Gasket	\$12.52
C9589	Ignition Cover Gasket	\$10.88
C9590	Clutch Cover Gasket	\$10.88

## Rotax 250 Gaskets

Part #	Description	Price
C9591	Center Case Gasket	\$13.64
C9592	Clutch Cover Gasket	\$15.03
C9593	Intake Gasket	\$5.67
C9594	Base Gasket .020" Kevlar Fiber	\$7.89

## Polaris Victory V92C Head & Base Gaskets

Part #	Description	Price
C8652	.97mm Head Gasket (1 Pair) / 754cc	\$182.22
C8653	101mm Head Gasket (1 Pair) / 817cc	\$182.22

### Cometic MLS Head Gasket Instructions for Harley Davidson Evolution & Twin Cam applications

**NOTE: DO NOT USE THE CYLINDER HEAD ALIGNMENT DOWEL O-RING WHEN USING AN MLS GASKET.**

**NOTE: COMETIC GASKET RECOMMENDS THE HEAD BOLTS BE SET AT A FINAL TORQUE OF 42FT-LBS.**

1. Check all gasket surfaces for flatness and imperfections, an excessively rough finish may cause gasket failure. A 50RA surface is recommended.
2. Check all hardware for defects, clean all threads and lubricate with light machine oil. Including the underside flange of the head bolts. (Wipe away any excess.)
3. There are two short and two long head bolts. The short go on the spark plug side while the long go on the pushrod side.
4. Before installing the head, place the head gasket on the cylinder and locate the gasket using the cylinder head alignment dowels (NOTE: The gasket is embossed around the dowel area and the dowel holes are smaller. Do not use dowel alignment o-rings with an MLS gasket.)
5. Once the gasket is located in place make sure the gasket fits your bore. The gasket should not hang in the bore or combustion chamber in any area.
6. If using a head or cylinder other than stock, check brass rivet location to ensure the rivet does not interfere with the sealing surface in any way. Some aftermarket castings are substantially larger than stock castings and may interfere. Simply remove the brass rivets, "side cutters work well".
7. Once proper fitment is established proceed with head installation and torque. (NOTE: See illustration for sequence.)
8. Alternately snug all the head bolts finger tight.
9. In sequence tighten all head bolts to 9 ft-lbs. Then in sequence tighten all head bolts to 14 ft-lbs. Again in sequence tighten all head bolts to 22 ft-lbs. Then in sequence tighten all head bolts to 35 ft-lbs and finally torque all head bolts to a final torque of 42ft-lbs in sequence.

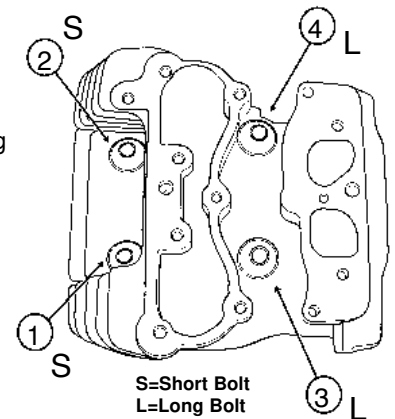

**Note: Failure to comply with any or all of these instructions may result in premature failure of the head and or base gasket.**

**Note: All Panhead, Shovelhead & Iron Sportster models use factory specs when using an MLS head gasket.**



**WARNING:** Cancer and Reproductive Harm [www.P65Warnings.ca.gov](http://www.P65Warnings.ca.gov)



# Karting Gaskets



Cometic Gasket - An Exclusive NASCAR Performance® Product

## BRIGGS & STRATTON

Model	Year	Bore Size	Top End Kit #	List Price	Component #	Component Description	List Price	OEM Part #
<b>5HP RAPTOR</b>	All	68.5MM	C104	\$22.32	H0694043F	68.5mm Bore Head Gasket Comp. Fiber	\$5.72	
					IR081047F	Intake Gasket (1.400" Spacing)	\$1.20	
					IR084015F	Carburetor Mount Gasket Tillotson	\$1.20	
					IR085125KF	Intake Gasket (1.800" Spacing)	\$1.20	
					EX113020C	Exhaust Gasket Copper	\$2.50	
					EX113042AM	Exhaust Gasket Fiber	\$2.13	
					CB021060F	Fuel Tank Mounting Gasket	\$1.20	
					CB023015R	Carburetor Diaphragm Gasket	\$2.13	
					EC102047F	Breather Cover Gasket	\$1.20	
					EC103015F	Side Cover Gasket .015"	\$1.92	
					EC103020F	Side Cover Gasket .020"	\$1.92	

• Suggested Oil: Klotz KL-870

<b>ANIMAL</b>	All	69.5MM	C187	\$34.35	H3590040S	69.5mm Head Gasket Multi-Layer Steel	\$19.24	555698	
			70.5MM	C200	\$34.35	H3590SP1040S	70.5mm Head Gasket Multi-Layer Steel	\$19.24	555698
		• Suggested Oil: Klotz KL-870				IR786060AFM	Intake Gasket	\$1.20	691885
						EC1424060AFM	Cylinder Head Plate Gasket	\$1.20	694088
						EC1426060AFM	Breather Cover Gasket	\$5.17	691890
						EC1425032AFM	Side Cover Gasket	\$7.54	699485

<b>LO206</b>	All	69.5MM	C199	\$34.04	H3590SP2060HTS	69.5mm Head Gasket Graphite	\$18.93	555723
					IR786060AFM	Intake Gasket	\$1.20	691885
					EC1424060AFM	Cylinder Head Plate Gasket	\$1.20	694088
					EC1426060AFM	Breather Cover Gasket	\$5.17	691890
					EC1425032AFM	Side Cover Gasket	\$7.54	699485

• Suggested Oil: Klotz KL-870

<b>WORLD FORMULA</b>	All	69.5MM	C188	\$36.78	H3590040S	69.5mm Head Gasket Multi-Layer Steel	\$19.24	555698
					IR1376015F	Intake Gasket	\$1.20	557044
					EX1676059F	Exhaust Gasket	\$2.43	691893
					EC1424060AFM	Cylinder Head Plate Gasket	\$1.20	694088
					EC1426060AFM	Breather Cover Gasket	\$5.17	691890
					EC1425032AFM	Side Cover Gasket	\$7.54	699485

• Suggested Oil: Klotz KL-870

## HONDA

Model	Year	Bore Size	Top End Kit #	List Price	Component #	Component Description	List Price	OEM Part #
<b>GX200 CLONE</b>	All	68MM	C192	\$39.80	H3096010S	68mm Head Gasket	\$14.44	
					IR836020F	Intake Gasket	\$1.20	
					CB307020F	Carburetor Flange Gasket	\$3.80	
					IR1381094KF	Air Filter Adapter Gasket	\$2.80	
					EX1033042AM	Exhaust Gasket	\$4.60	
					VC207047KF	Valve Cover Gasket	\$5.34	
					EC1453020F	Side Cover Gasket	\$11.42	

• Suggested Oil: Klotz KL-870

<b>STOCK SHIFTER CR125</b>	97-99	55MM	C189	\$50.93	H0225010S	55mm Head Gasket	\$17.38	12251-KZ4-A91
					B0314018AFM	Base Gasket	\$5.34	12191-KZ4-L10
					B0009018AFM	Base Gasket '97 Cylinders Only	\$5.34	2191-KZ4-860
					IR003018AFM	Intake Reed Gasket	\$3.80	14132-K56-701
					EX006042AM	Exhaust Gasket	\$4.65	18291-KZ4-700
					PV001018AFM	Right Power Valve Gasket	\$3.80	12108-KZ4-700
					PV002018AFM	Left Power Valve Gasket	\$3.80	12109-KZ4-700
					PV003018AFM	Upper Power Valve Gasket	\$3.80	12112-KZ4-700
					R19X3V	Water Outlet O-ring	\$3.02	91312-KE7-003

• Suggested Oil: Klotz KL-104

<b>STOCK SHIFTER CR125</b>	00	54MM	C190	\$39.53	H0928010S	54mm Head Gasket	\$17.38	12251-KZ4-A91
					B0314018AFM	Base Gasket	\$5.34	12191-KZ4-L10
					IR003018AFM	Intake Reed Gasket	\$3.80	14132-K56-701
					EX006042AM	Exhaust Gasket	\$4.65	18291-KZ4-700
					PV091032AFM	Power Valve Gasket	\$5.34	12108-KZ4-A90
					R19X3V	Water Outlet O-Ring	\$3.02	91312-KE7-003

• Suggested Oil: Klotz KL-104

<b>STOCK SHIFTER CR125</b>	01-02	54MM	C191	\$49.05	H0928010S	54mm Head Gasket	\$17.38	12251-KZ4-A91
					B0490018AFM	Base Gasket	\$7.38	12191-KZ4-L10
					EX006042AM	Exhaust Gasket	\$4.65	18291-KZ4-700
					IR003018AFM	Intake Gasket Reed To Carb Boot	\$3.80	14132-K56-701
					PV091032AFM	Power Valve Gasket	\$5.34	12108-KZ4-A90
					R124S	Expansion Cham O-Rings (2 Req.)	\$3.74	
					R19X3V	Water Outlet O-Ring	\$3.02	91312-KE7-003

• Suggested Oil: Klotz KL-104







# Karting Gaskets



Cometic Gasket - An Exclusive NASCAR Performance® Product

## HONDA

Model	Year	Bottom End Kit #	List Price	Component #	Component Description	List Price	OEM Part#
<b>STOCK SHIFTER CR125</b>	97-02	C189BE	\$61.16	EC083032AFM	Inner Clutch Cover Gasket	\$6.71	11394-KZ4-A90
				EC185020F	Center Case Gasket	\$16.13	11191-KZ4-620
				EC228	Clutch Cover Gasket	\$11.36	91311-KS6-700
				EC510060AFM	Magneto Cover Gasket	\$6.25	11352-KS6-700
				IR003018AFM	Intake Gasket	\$3.80	14132-KY4-970
				WP033018AFM	Water Pump Gasket	\$4.94	19229-KZ-620
				R16X3V	Fill Plus O-Ring	\$1.26	91303-800-000
				R20X2V	Output Shaft O-Ring	\$3.02	94109-12000
				WA133	Water Pump Drain Plug Gasket	\$0.90	90543-273-000
				WA117	Drain Plug Gasket	\$0.95	94109-12000

## IAME

Model	Year	Bore Size	Top End Kit #	List Price	Component #	Component Description	List Price	OEM Part #
<b>MINI SWIFT</b>	All	41.8MM	C193	\$21.61	H4377005C	Head Gasket .005"	\$6.25	A-61049
					B1358015F	Base Gasket	\$6.25	EBP-85045
					IR1380020F	Intake Gasket	\$2.80	A-61822
					EX1684059F	Exhaust Gasket	\$4.15	A-61360
					WA146	Copper Washer	\$2.16	
• Suggested Oil: Klotz KL-104								
<b>LEOPARD</b>	08-Later	54MM	C194	\$40.45	R143V	Inner Head O-Ring	\$8.35	DBP-95049
					R249B	Outer Head O-Ring	\$5.08	B-25820
					R8X1.5V	Stud O-Ring (4 Req.)	\$1.81	B-25825
					B1354015F	Base Gasket	\$6.25	BP-25045
					IR1370032AFM	Intake Manifold Gasket	\$3.45	11810
					IR1371031F	Intake Reed Block Gasket	\$2.80	11805-A
					CB456039F	Carburetor Gasket	\$1.20	10360-A
					EX1674059F	Exhaust Gasket	\$4.15	B-85360
					WA082063C	Temp Sensor Washer	\$1.93	B-25845
					• Suggested Oil: Klotz KL-104			
<b>LEOPARD MY09</b>	All	54MM	C195	\$39.80	R143V	Inner Head O-Ring	\$8.35	DBP-95049
					R249B	Outer Head O-Ring	\$5.08	B-25820
					R8X1.5V	Stud O-Ring (4 Req.)	\$1.81	B-25825
					B1213015F	Base Gasket	\$6.25	EBP-125045
					IR1368031F	Intake Manifold Gasket	\$2.80	F-11810
					IR1369031F	Intake Reed Block Gasket	\$2.80	F-11805
					CB456039F	Carburetor Gasket	\$1.20	10360-A
					EX1674059F	Exhaust Gasket	\$4.15	B-85360
					WA082063C	Temp Sensor Washer	\$1.93	B-25845
					• Suggested Oil: Klotz KL-104			
<b>X30</b>	All	54MM	C196	\$47.72	R59X2.5V	Inner Head O-Ring	\$6.84	D-37049
					R246B	Outer Head O-Ring	\$5.08	F-38820
					R8X1.5V	Stud O-Ring (4 Req.)	\$1.81	B-25825
					B1213015F	Base Gasket .015"	\$6.25	EBP-125045
					IR1369031F	Intake Manifold Gasket	\$2.80	F-11805
					IR1368032AFM	Intake Reed Block Gasket	\$2.80	X30125810
					CB456039F	Carburetor Gasket	\$1.20	10360-A
					EX1673059F	Exhaust Gasket	\$4.15	B-75360
					WA213043C	Temp Sensor Washer	\$1.40	B-25845
					WA214050C	Water Pipe Washer	\$1.65	B-25835
					EC2206032AFM	Magneto Cover Gasket	\$6.50	X30125878
					R329B	Magneto Damper O-Ring	\$1.81	X30125853
					• Suggested Oil: Klotz KL-104			

## PRD

Model	Year	Bore Size	Top End Kit #	List Price	Component #	Component Description	List Price	OEM Part #
<b>PRD FIREBALL</b>	All	54MM	C197	\$30.18	R143V	Inner Head O-Ring	\$8.85	9012555
					R249B	Outer Head O-Ring	\$5.08	9011555
					R015V	Stud O-Ring (4 Req.)	\$1.13	9024555
					B1355012F	Base Gasket	\$3.55	9057555A
					IR1374020F	Intake Manifold Gasket	\$2.15	9101555
					IR1375020F	Intake Reed Block Gasket	\$2.15	9100555
					CB457020F	Carburetor Gasket	\$0.83	9107555
					EX1675064AM	Exhaust Gasket	\$3.55	9021555
					• Suggested Oil: Klotz KL-104			



**WARNING:** Cancer and Reproductive Harm www.P65Warnings.ca.gov



# Karting Gaskets



Cometic Gasket - An Exclusive NASCAR Performance® Product

## ROTAX

Model	Year	Bore Size	Top End Kit #	List Price	Component #	Component Description	List Price	OEM Part #
FR125 MAX EVO	All	54MM	C198	\$36.62	R037V	Inner Head O-Ring	\$11.34	250 160
					R155B	Outer Head O-Ring	\$1.13	250 280
					R118B	Spark Plug O-Ring	\$1.13	430 782
					B1356012F	Base Gasket .012"	\$3.90	650 480
					B1356015F	Base Gasket .015"	\$3.90	650 481
					B1356020F	Base Gasket .020"	\$4.18	650 482
					B1356031F	Base Gasket .031"	\$4.18	650 483
					IR1377031F	Intake Manifold Gasket	\$2.28	250 521
					EX1677059F	Exhaust Gasket	\$3.75	250 271
					PV154031F	Power Valve Gasket	\$0.83	250 231

• Suggested Oil: Klotz KL-104

## YAMAHA

Model	Year	Bore Size	Top End Kit #	List Price	Component #	Component Description	List Price	OEM Part #
KT100	All	54MM	C134	\$24.38	H0524032C	Head Gasket	\$6.19	
					B0308015F	Base Gasket	\$2.70	
					CB030015F	Intake Carb Spacer (2 Req.)	\$1.35	
					CB031015F	Intake Manifold to Carb Gasket	\$1.61	
					EX131	Exhaust Gasket	\$6.86	
					EC181012F	Center Case Gasket	\$4.32	

• Suggested Oil: Klotz KL-104

YF200R1	All	71MM	C184	\$53.61	H1795036S	Head Gasket Multi-Layer Steel	\$11.18	F21-304-30
					IR369018AFM	Intake Gasket	\$4.60	F21-310-00
					EX476042AM	Exhaust Gasket	\$4.60	F21-309-00
					EC758018AFM	Tilloston Flange Gasket	\$4.77	F21-318-00
					EC759020RC	Side Cover Gasket	\$12.39	F21-317-00
					VC076060AFM	Valve Cover Gasket	\$8.06	F21-314-00
					VC077032AFM	Valve Cover Baffle	\$8.01	F21-315-00

• Suggested Oil: Klotz KL-870



## Karting Gasket Illustrations



B0009018AFM



B0308015F



B0314018AFM



B0490018AFM



B1213015F



B1354015F



B1355012F



B1356012F



B1358015F



CB021060F

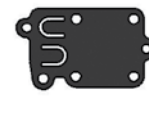

CB023015R



CB030015F



CB031015



CB307020F



CB456039F



CB457020F

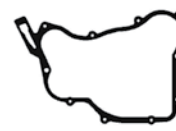

EC083032AFM



EC102047F



EC103015F



EC103020F



EC181012F



EC185020F



EC510050AFM



EC758018AFM

## Karting Gasket Illustrations



EX1675064AM



EX1676059F



EX1677059F



EX1684059F



H0225010S



H0694043F



H0928010S



H1795036S



H3096010S



H3590040S



H4377005C

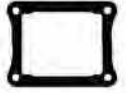

IR003018AFM



IR081047F



IR084015F



IR085125KF



IR369018AFM



IR786060AFM



IR836020F



IR836029F

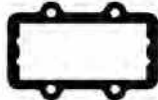

IR1368031F



IR1369031F

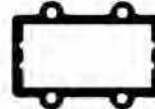

IR1370032AFM

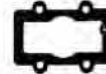

IR1371031F



IR1374020F



IR1375020F



IR1376015F



IR1377031F



IR1380020



IR1381094KF

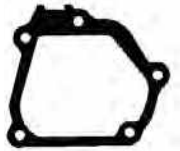

PV001018AFM



PV002018AFM



PV003018AFM



PV091032AFM



PV154031F



VC076060AFM



VC077032AFM



VC207047KF



EC759020RC



EC1424060AFM

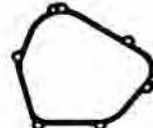

EC1425032AFM



EC1426060AFM

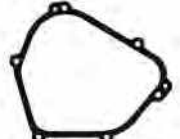

EC1453020F

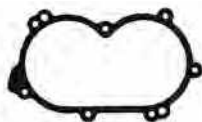

EC2206032AFM



EX1576SP1



EX006042AM



EX476042AM



EX1033042AM



EX1673059F



EX1674059F





Klotz Synthetic Lubricants are designed and engineered to be the best lubricants in the motorsports industry. Race tested and formulated for all engine types, Klotz offers a full line of Estorlin Synthetic Racing Oils, Power Additives, and Aerosols needed to keep you engine protected and performing at an optimal level. Racers, engine builders, and performance enthusiasts around the world rely on Klotz to get them to the checkered flag. Be Fast, Be First with Klotz Synthetic Lubricants. For more information, Tech Sheets, or MSDS Sheets please visit [shopengineparts.com](http://shopengineparts.com)

## 2-STROKE LUBRICANTS Available Individually, Case, 30 gal. & 55 gal. drum



### SUPER TECHNIPLATE®

Part#	Description	Price
KL-103-1	1 Pint Bottle	\$8.81
KL-100-1	1 Quart Bottle	\$14.39
KL-109-1	1/2 Gallon Bottle	\$27.09
KL-101-1	1 Gallon Bottle	\$54.68

### ORIGINAL TECHNIPLATE®

Part#	Description	Price
KL-200-1	1 Quart Bottle	\$14.39
KL-205-1	1 Gallon Bottle	\$54.68

### BeNOL® RACING CASTOR LUBRICANT

Part#	Description	Price
BC-175-1	1 Pint Bottle	\$8.90
BC-172-1	1 Quart Bottle	\$14.84
BC-179-1	1/2 Gallon Bottle	\$25.97
BC-171-1	1 Gallon Bottle	\$58.40

### MOTORCYCLE TECHNIPLATE® TC-2

Part#	Description	Price
KL-300-1	1 Quart Bottle	\$12.90
KL-301-1	1 Gallon Bottle	\$49.01

### R-50® RACING TECHNIPLATE®

Part#	Description	Price
KL-102-1	1 Pint Bottle	\$9.60
KL-104-1	1 Quart Bottle	\$16.69
KL-105-1	1 Gallon Bottle	\$64.72

### MOTORCYCLE TECHNIPLATE® TC-W3

Part#	Description	Price
KL-302-1	1 Quart Bottle	\$13.38

### 50:1 TECHNIPLATE® TC-W3

Part#	Description	Price
KL-305-1	1 Pint Bottle	\$8.32
KL-304-1	1 Quart Bottle	\$13.38

### SKICRAFT® TECHNIPLATE®

Part#	Description	Price
KL-306-1	1 Quart Bottle	\$13.38
KL-307-1	1 Gallon Bottle	\$50.83

### RACING SYNTHETIC FORK & SHOCK FLUID

Part#	Description	Price
KL-505-1	1 Quart Bottle 5W	\$15.91
KL-515-1	1 Quart Bottle 10W	\$15.91
KL-515-1	1 Quart Bottle 15W	\$15.91

## 4-STROKE LUBRICANTS Available Individually, Case, 30 gal. & 55 gal. drum



### ATV/UTV SYNTHETIC ENGINE LUBRICANT

Part#	Description	Price
ATVUTV-040-1	0W/40 1 Qt. Bottle	\$14.93
ATVUTV-550-1	5W/50 1 Qt. Bottle	\$14.93

### ATV/UTV SYNTHETIC ENGINE LUBRICANT WITH INTEGRATED TRANSMISSION

Part#	Description	Price
ATVUTV-1040-1	10W/40 1 Qt. Bottle	\$14.93

### MOTORCYCLE TECHPLATE® WITH INTEGRATED TRANSMISSION

Part#	Description	Price
KL-815-1	15W/50 1 Qt. Bottle	\$14.83
KL-830-1	10W/30 1 Qt. Bottle	\$14.83
KL-840-1	10W/40 1 Qt. Bottle	\$14.83
KL-850-1	20W/50 1 Qt. Bottle	\$14.83

### SIDE X SIDE SYNTHETIC ENGINE LUBRICANT

Part#	Description	Price
KL-802	5W/50 1 Qt. Bottle	\$14.93
KL-805	10W/50 1 Qt. Bottle	\$14.93
KL-803	10W/30 1 Qt. Bottle	\$14.93
KL-806	15W/50 1 Qt. Bottle	\$14.93

### PURE ESTORLIN® MARINE

Part#	Description	Price
KE-330	10W/30 1 Qt. Bottle	\$14.27
KE-331	10W/30 1 Gallon Bottle	\$52.03
KE-340	25W/40 1 Qt. Bottle	\$14.27
KE-341	25W/30 1 Gallon Bottle	\$52.03
KE-334	10W/40 1 Qt. Bottle	\$14.27
KE-335	10W/30 1 Gallon Bottle	\$52.03

### PURE ESTORLIN® KART LUBRICANT

Part#	Description	Price
KE-220-1	1 Quart Bottle 0W/20	\$15.70
KE-230-1	1 Quart Bottle 0W/30	\$15.70
KE-240-1	1 Quart Bottle 0W/40	\$15.70
KE-225-1	1 Quart Bottle 5W/20	\$15.70





**TRANSMISSION GEAR LUBE**

Part#	Description	Price
KH-GL90-1	80W/90 1 Qt. Bottle	\$19.75
KH-GL140-1	75W/140 1 Qt. Bottle	\$19.75

**GEAR AND CHAIN CASE LUBRICANT**

Part#	Description	Price
KH-S80-1	1 Qt. Bottle	\$19.28

**PRIMARY CASE LUBRICANT**

Part#	Description	Price
KH-C80-1	1 Qt. Bottle	\$18.76



**MULTI-VISCOSITY SYNTHETIC ENGINE LUBRICANT**

Part#	Description	Price
KH-1040-1	10W/40 1 Qt. Bottle	\$16.94
KH-2050-1	20W/50 1 Qt. Bottle	\$15.10
KH-2560-1	25W/60 1 Qt. Bottle	\$16.00
KV-2040-1	20W/40 1 Qt. Bottle	\$15.38
KV-1560-1	5W/60 1 Qt. Bottle	\$16.00

**STRAIGHT WEIGHT SYNTHETIC ENGINE LUBRICANT**

Part#	Description	Price
KH-50-1	SAE 50 1 Qt. Bottle	\$15.23
KH-60-1	SAE 60 1 Qt. Bottle	\$15.23
KH-70-1	SAE750 1 Qt. Bottle	\$15.23

**LUBES**

	Part#	Size	Price
ATV/UTV Front/Rear End .....	ATV/UTV-8090-1	1 qt.	\$15.58
Differential Lube			
Flex Drive® 30 Transmission Lubricant .....	KL-506-1	1 qt.	\$15.91
Chain Case Lube .....	KL-500-1	12.oz.	\$10.30
Chain Lube Aerosol .....	KL-605-1	15.25oz	\$10.95
KLR® Clean Chain Lube .....	KL-611-1	16oz.	\$10.95
Jet Pump Lube .....	KL-511-1	4oz.	\$7.09



**ADDITIVES & AEROSOLS**

	Part#	Size	Price
Assembly Lube .....	KL-311-1	12oz.	\$9.98
Fogon - Storage & Afterrun Lubricant .....	KL-610-1	16oz.	\$8.07
Foam Air Filter Oil .....	KL-606-1	15.25oz	\$9.28
Fabric Air Filter Oil .....	KL-607-1	15.25oz	\$8.84
Filter Cleaner .....	KL-608-1	15.25oz	\$9.85
Plug & Contact Cleaner .....	KL-609-1	12.5oz	\$10.14
Ethanol Gasoline Fazeseparation Treatment .....	KL-603-1	16oz.	\$10.73
	KL-623-1	1gal.	\$55.55
Storbilizer .....	KL-613-1	16oz.	\$11.28
	KL-633-1	1gal.	\$61.05
Cometic Engine Block & Head Surface Cleaner .....	C1047-1	15.25oz	\$9.95
Octane Booster .....	KL-602-1	16oz.	\$11.49
	KL-628-1	1gal.	\$65.89



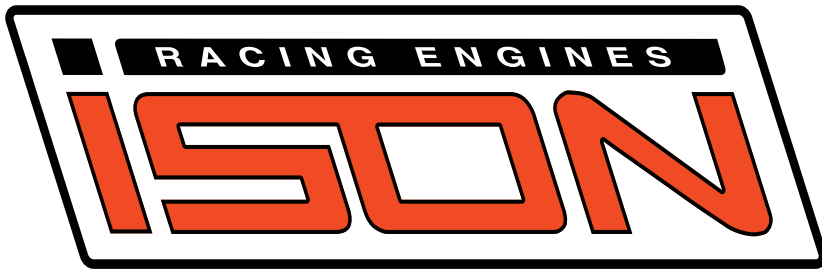

Phone (440) 853-2332

Address 8090 Auburn Road, Concord OH 44077

email sales@isonracingengines.com

web www.isonracingengines.com

www.facebook.com/IsonRacingEngines

@IsonRacing

## Ison is a full service performance engine builder, serving the powersports and automotive industries.

Ison provides precision workmanship by our experienced staff for everything from complete engine builds and dyno testing, to component machining and assembly.

Outfitted with the finest equipment including Sunnen hones, Kwik-Way boring bars, Serdi seat cutters, and Haas 5-axis CNC mills, close tolerance machining and repeatability can be expected. To complete our expansive list of services, we have added engine dyno testing which is made possible by our new in-house Superflow 902S dyno.

Our extremely clean state-of-the-art facility is a testament to our principles and dedication to quality when working on your power plant.

### NEW! Superflow 902S Engine Dyno



## Ison Services

### Automotive Services

- Resurfacing and Square Decking
- Align Honing
- Boring and Sleaving
- Diamond Honing
- Dynamic Balancing
- Cylinder Head Reconditioning
- Standard and Radius Valve Job
- Capability
- Port Machining
- Valve Guide Reconditioning
- Valve Seat Repair
- Complete Engine Builds
- Engine Dyno Testing

### Powersports and V-Twin Services

- 2 and 4 Stroke Cylinder Sleaving
- Port Matching
- Boring and Honing
- Case Boring
- Complete Cylinder Head Service



# Engine Services

isonracingengines.com • 440.854.2332

## Cylinder Boring & Honing

Part#	Description	List
CB2	2 Cycle / Per Hole up to 1mm over...	\$90.00
CB4	4 Cycle / Per Hole up to 1mm over...	\$81.00
CB4SC	4 Cycle, Briggs, Kohler per hole	\$119.00
CB4M	4 Cycle up to 2mm over	\$95.34
CB4	4 Cycle / Per Hole up to 1mm over...	\$73.33

## Cylinder Honing

Part#	Description	List
CH2	2 Cycle / Deglaze Per Hole	\$42.00
CH4	4 Cycle / Deglaze Per Hole	\$35.00
CH2M	2 Cycle Hone Multiple Holes 3 & 4 Cyl. Blocks	\$30.00
CH4M	4 Cycle Hone Multiple Holes 3 & 4 Cyl. Blocks	\$25.00

## Cylinder Resleeving

Part#	Description	List
CS2	Most 2-Cycle w/o Power Valve (Labor only Sleeve price not included)	\$209.00
CS2V	Most 2-Cycle w/ Power Valve (Labor only Sleeve price not included)	\$250.00
CS4	Most 4-Cycle drop in /per hole (Labor only Sleeve price not included)	\$110.00
CS4B	Most 4-Cycle where cylinder must be bored to accept a larger sleeve/ per hole (Labor only Sleeve price not included)	\$135.00
CS4C	4-Cycle where extensive machining is req. 3mm or larger / Liquid cooled Big Bore (Labor only sleeve price not included per hole)	\$219.00
CS2B	2-Cycle big bore resleeve without power valve	\$221.00
PMTS	Port match thick sleeve 2-Cycle installation TRX,Blaster,Banshee, etc, per cylinder	\$99.00
PMPC	Port match 2 stroke sleeve to ported cylinder, starting at	\$165.00

## Additional Services

Part#	Description	List
CO4	O-Ring 4-Cycle Block / per hole	\$55.00
GSKTM	Gasket Removal Multiple Cylinder	\$54.00
GSKTS	Gasket Removal Single Cylinder	\$31.00
HC	Heli Coil / Per Hole	\$44.00
SR	Remove Cylinder Head Stud	\$4.00
LH	Additional Labor (Per Hour)	\$106.00
BB	Bead Blast (Single Cylinder)	\$26.00
PVA	Re-assemble Power Valve Complete	\$66.00
PVR	Power Valve Removal	\$25.00
PMRP	Port Match Sleeve to existing ported cylinder	\$100.00
CHP	2-Cycle cylinder head polish	\$34.00
CRC	2-Cycle chamber recut / squish	\$56.00

## MONO Block

Part#	Description	List
MBCB4	4-Cycle bore and hone per hole	\$103.00
MBJW	Jet wash block * req. with any block	\$45.00
MBCS4	Sleeve install (labor only) per hole	\$209.00
MBD	Deck block	\$67.00

## 4-Cycle Head Services

Part#	Description	List
VJ2VS	Valve Job 3 angle - 2 Valve Single Cylinder Head (Disassembly, Inspection, Valve Job, Reassembly complete w/New Valve Stem Seals)	\$175.00
VJ4VS	Valve Job 3 angle - 4 Valve Single Cylinder Head (Disassembly, Inspection, Valve Job, Reassembly complete w/New Valve Stem Seals)	\$225.00
VJ5VS	Valve Job 3 angle - 5 Valve Single Cylinder Head (Disassembly, Inspection, Valve Job, Reassembly complete w/New Valve Stem Seals)	\$250.00
VJM	Valve 3 angle - Multi Cyl. Head (ea)	\$40.00
VJOR	Valve Job +1mm/2mm Oversize Radius (ea)	\$65.00
VGRR	Valve Guide (removal, replace, resize, (guide not incl.)	\$30.00
VSRR	Valve Seat removal, replace, recut (seat not incl.)	\$70.00
CDH	Deck Cyl. Head/Base Single Head	\$54.00
CHHI	Deck Cylinder Inline	\$100.00
VJOHC	Where camshaft and rockers are integral to the head like Yamaha Rhino, Grizzly, Wolverine and most utility quads. Dissassembly, valve job, cleaning, assembly and lash to spec	\$313.00
VJ400	Includes everything in a VJ4VS but specs to TRX400EX	\$254.00
SBVL	Lash shim over bucket cylinder head 4 valve	\$119.00

## V-Twin Cylinder Services

Part#	Description	List
HDHP	Hone Pan/Shovelhead (ea.)	\$37.50
HDH	Hone Evo & Twin Cam w/torque plates (ea.)	\$69.00
HDBP	Bore & Hone Pan/Shovelhead (ea.)	\$69.00
HDCB	Bore & Hone Evo/Twin Cam w/torque plates	\$109.00
HDCBB	883 to 1200 Big Bore Conversion (ea.)	\$157.00
HDDC	Deck Cylinder Evo & Twin Cam (ea.)	\$45.00
HDS58	Sleeve Evo & Twin Cam Cyl, labor only (ea.)	\$186.00
HDCBM	Multi pass Bore & Hone Evo & T/C w/torque plates (ea.)	\$125.00

## V-Twin Engine Case Services

Part#	Description	List
HDC58	Bore Cases for Big Bore Cylinders (both holes)	\$245.00
HDSR	Remove studs Evo & Twin Cam (8 studs)	\$25.00
HDHT	Hot Tank Clean Engine Cases	\$40.00

## V-Twin Engine Head Services

Part#	Description	List
HDCVJ	Complete Valve Service (per head)	\$150.00
HDCVS	Cut Valve & Seat (ea.)	\$36.00
HDIS	Install Seat (ea.)	\$75.00
HDIG	Install Guide (ea.)	\$31.00
HDRH	Resurface Head (ea.)	\$45.00

## 4-Cycle Head Services

Part#	Description	List
VJ2VS	Valve Job 3 angle - 2 Valve Single Cylinder Head (Disassembly, Inspection, Valve Job, Reassembly complete w/New Valve Stem Seals)	\$175.00
VJ4VS	Valve Job 3 angle - 4 Valve Single Cylinder Head (Disassembly, Inspection, Valve Job, Reassembly complete w/New Valve Stem Seals)	\$225.00
VJ5VS	Valve Job 3 angle - 5 Valve Single Cylinder Head (Disassembly, Inspection, Valve Job, Reassembly complete w/New Valve Stem Seals)	\$250.00
VJM	Valve 3 angle - Multi Cyl. Head (ea)	\$40.00
VJOR	Valve Job +1mm/2mm Oversize Radius (ea)	\$65.00
VGRR	Valve Guide (removal, replace, resize, (guide not incl.)	\$30.00
VSRR	Valve Seat removal, replace, recut (seat not incl.)	\$70.00
CDH	Deck Cyl. Head/Base Single Head	\$54.00
CHHI	Deck Cylinder Inline	\$100.00
VJOHC	Where camshaft and rockers are integral to the head like Yamaha Rhino, Grizzly, Wolverine and most utility quads. Dissassembly, valve job, cleaning, assembly and lash to spec	\$313.00
VJ400	Includes everything in a VJ4VS but specs to TRX400EX	\$254.00
SBVL	Lash shim over bucket cylinder head 4 valve	\$119.00

## Marine Engine Services

Part#	Description	List
CS2MPH	2-Cycle resleeve power head per hole	\$313.00
CS4MPH	4-Cycle resleeve power head per hole	\$238.00
CH4MPH	4-Cycle hone power head per hole	\$38.00
CH2MPH	2-Cycle hone power head per hole	\$44.00
CB4MPH	4-Cycle bore & hone power head per hole	\$94.00
CB2MPH	2-Cycle bore, hone, champer power head per hole	\$106.00
DMPHI	Deck inline power head	\$126.00
DMPHV	Deck v style power head per side	\$104.00
MPHJW	Jet wash block req. with any block	\$51.00





# Product Development



Cometic Gasket - An Exclusive NASCAR Performance® Product

Cometic provides our customers with quality products, born of exhaustive research and development. Cometic's Superflow 902S dynamometer positions us at the forefront of gasket design and technology. Our state-of-the-art testing facilities and processes provide Cometic with the resources necessary to analyze gasket designs and materials in the most extreme conditions, ensuring that your gasket won't fail when you need it the most.

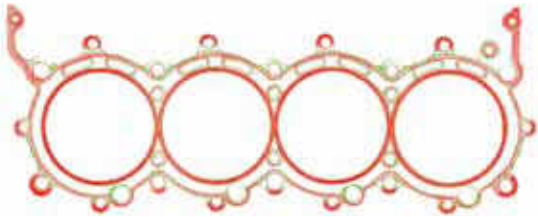

Gasket contact pressure is validated by Fuji film at our in-house research and development center.

## Promotional Items



Part #	Description	Price
DC15	Package Decal 5.25" x 1.75"	\$.05
DC06	Decal Sheet 5.5" x 8.5"	\$1.00
DC10	Embroidered Patch 2" x 5"	\$2.00
DC04	Trailer Decal 6" x 19"	\$4.00
DC03	Decal 3.125" x 9"	\$1.00
DC11	Banner 3' x 8'	\$10.00
DC17	StreetPro Decal 1.625" x 9"	\$.50
DC13	Dealer Open House Kit	\$61.99
	(100) DC01, (2) DC04, (2) DC11, (2) DC12, (10) 40% Off Retail Certificates, (25) Catalogs	
DC12	Adjustable Embroidered Hat	\$10.00

### WARRANTY DISCLAIMER\*

Due to the nature of performance applications, the parts in this catalog are sold without any express warranty or any implied warranty of merchantability or fitness for a particular purpose. Cometic Gasket Inc. shall not, under any circumstances, be liable for any special, incidental or consequential damages, including, person, party or property, but not limited to, damage, or loss of property or equipment, loss of profits or revenue, cost of purchased or replacement goods, or claims of customers of the purchase, which may arise and/or result from sale, installation or use of these parts. Installation of these parts could adversely affect the motor manufacturers warranty coverage.

VENUE-The agreed upon venue, in the event of any dispute whatsoever between the parties, whether instituted by either party, including, but not limited to, contract terms, payment terms, delivery, type, defects, sufficiency of product, shall be the Court of Common Pleas, Lake County, Ohio or the Painesville Municipal Court, Lake County, Ohio, depending on the amount in controversy. This agreement shall be governed by and construed under the laws of the State of Ohio.

All prices and terms are subject to change without notice.

Terms Open accounts may be established by well rated firms. A credit application is available upon request. Open accounts are due payable Net 30 days from date of invoice. No statement will be sent. If an account becomes 60 or more days past due, it is subject to being placed on credit hold. No orders will be shipped or new orders accepted until past due balance is paid. If an account becomes 90 or more days past due, it is subject to being placed for collections. All costs of collection are the responsibility of the customer, including attorney fees, court costs, and other expenses of litigation.

Returns- Authorization (RGA) must be obtained in advance on all returns. A packing slip or invoice number must accompany the merchandise. No returns after 30 days from invoice date. All returns are subject to a 25% restocking charge. All custom designed and custom manufactured gaskets are non-returnable. Only catalog parts are returnable.

Review your invoice and notify us immediately of any incorrect or inaccurate information. Shortages must be reported within 10 days.





Made in the U.S.A.

# OEM Production

One Source for Prototyping to Full Production

- Prototyping with economical tooling options.
- Full production Capabilities
- Quick turnaround
- In-house tool & die capabilities
- ISO 9001:2008 Certified
- We can assist in developing a sealing solution for nearly any environment.
- Personal attention by our dedicated staff. We currently supply production to many customers in the automotive, marine, powersports, industrial, and power generator industries.
- Stamping, Laser Cutting, Rubber Injection Molding and 5 Axis Machining

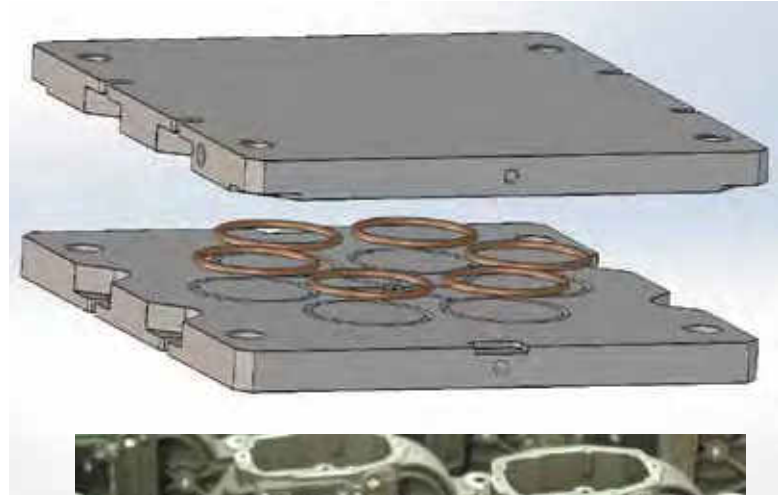

## Flexibility is Key

We understand many variables go into determining design, volume, and production forecasts. We are accustomed to working in an ever changing environment.

Maintain knowledge base and part awareness during the transition from the early stages of development all the way through production, without the hassle of changing suppliers.

Inventory turns are important. We can work together for a delivery solution that best fits your inventory level and cash flow needs.



**Call our Engineering Team today @ (440) 354-0777 for a quote**



**WARNING:** Cancer and Reproductive Harm [www.P65Warnings.ca.gov](http://www.P65Warnings.ca.gov)



## Contact Us

Order Toll Free By Calling (800) 752-9850

Cometic Gasket, Inc.  
8090 Auburn Road  
Concord, OH 44077

For Technical Assistance Call (440) 354-0777  
Fax (440) 354-0350  
email [info@cometic.com](mailto:info@cometic.com)  
web [www.cometic.com](http://www.cometic.com)

Method of Payment Mastercard/VISA

Ship Via UPS Next Day Air / 2nd Day Air / Regular Ground / 3 Day Ground Service

[facebook.com/cometic](https://facebook.com/cometic)

@CometicGasket

## Cometic Partners



Cometic Gasket, Inc. - An Exclusive NASCAR® Performance Product



The NASCAR® Performance logo and word mark are used under license by the National Association for Stock Car Auto Racing, Inc.

Copyright© 2019 Cometic Gasket, Inc.  
Cover photo courtesy of: Christian Marsh

PS19  
Printed in China

**California, Proposition 65 Warning.** The state of California has determined that certain chemicals used in the manufacture of this product have been known to cause cancer and birth defects. For more information, visit [www.p65Warnings.ca.gov](http://www.p65Warnings.ca.gov)

