



Beltenick®
Taiwan Racing Products Co.,Ltd
www.beltenick-trp.com

Head Office & Factory :

Taiwan Racing Products Co.,Ltd

NO.3-27,Dalun Rd.,Tatsun Hsiang,Changhua Hsien,Taiwan 51544

TEL:+886-4-853-1960

FAX:+886-4-853-2581

E-mail:tai.racing@beltenick-trp.com

Vietnam Factory :

Vietnam Racing Products Company Ltd

Lot CN-10.1,Thuan Thanh II Industrial Zone,Mao Dien village,Thuan Thanh District,

Bac Ninh Province,Vietnam

TEL:+84-222.3775865

FAX:+84-222.3775869

www.beltenick-trp.com





Fire Retardant Suit 25

Fire Retardant Suit 27

RSN-500A 27

RSN-500B 28

RSN-600 30

RSN-700A /RSN-700B 31

RS-01 32

RS-02 33

RS-02(2 Pieces) 34

Aramid Underwear 35

UW-01 / UW-06

SFI Underwear 35

UW-05

Aramid Balaclavas 36

HD-01 / HD-05 / HD-06 / SK-02 / SK-03

Helmet Support 36

HS-01

Gloves 37

GLN-400 / GLN-500 / GLN-600 / GLN-700

Boots 40

BTN-400

Seats 42

Seats 43

RST-300 / RST-500 / RST-600 / RST-700 / RST-800

RST-900 / RST-1100 / RST-1200 / UTV-100

Seat Mount 48

SSM-01 / SSM-02 / SSM-03 / SSM-04 / ASM-01

Steering Wheel 49

Steering Wheel 50

DR-100 / DR-101 / DR-102 / QR-100

**Keeping you together
with love ones.**

Taiwan Head Office & Factory.



Original Manufacturer From Taiwan & Vietnam

- ➡ Innovation
- ➡ Designing
- ➡ Testing
- ➡ Patented
- ➡ Approved and Homologated
- ➡ Manufacturing
- ➡ Shipping

We bring wealthy experience to mainly active in the world for competitive use of FIA & SFI since 1999.

Vietnam Factory





Fluo-Green



Fluo-Orange



Fluo-Pink



Fluo-Yellow



Red



Orange



Yellow



Pink



Purple



Blue



Green



Silver



Gold



Digital Camouflage



Camouflage



Black



Racing Harnesses

01



Racing Harnesses

RI-100 / RI-100A / RI-100SH / RI-200 / RI-300
RI-400HART / RI-500H / RI-600 / RJ-100 / RJ-200
BI-100 / BI-400 / RCU-101 / RCU-102 / RCU-1100A
TB-07 / TB-09 / RCU-1002H / RCU-1003 / RCU-1003H
RCU-1003PD / RCU-1004PU / RCU-1004PD / RCU-1005

Metal Parts

Window Net Mounting Kit

WM-6 / WM-7 / WM-8 / WM-9 / WM-10
WM-11 / WM-12 / WM-13

Window Net

WN-10 / WN-11

Helmet Net

WN-17 / WN-21

Arm Restraint

AR-01

Harness Pad

HP-01 / HP-02

FIA & SFI Harnesses

RI-100



3" Individual Shoulder Belts and 3" Pull down Lap Belts.
Single Sub Strap.



Bolt-in End



TR-10 TR-15



1" Pull Strap For Easy Adjust

RI-100A



3" Individual shoulder belts and 3" Pull down Lap belts.
Single sub strap.
Shoulder belt with Super light-weight Aluminum adjuster .



Bolt-in End



or Snap Hook End



TR-10 TR-15



TR-14A

Colours :

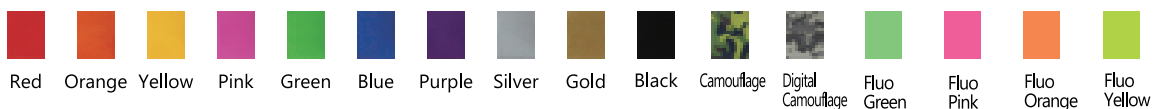

RI-100SH



3" Individual Shoulder Belts and 3" Pull down Lap Belts.
Single Sub Strap.



Snap Hook End



TR-10 TR-15



1" Pull Strap For Easy Adjust

RI-200



3" Individual shoulder belts and 3" Pull down Lap belts.
Single sub strap.
Super light-weight Aluminum adjusters on shoulder belts & lap belts.



Bolt-in End



TR-11 TR-12



TR-14A

Colours :

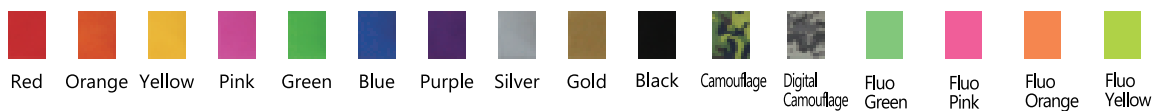

FIA & SFI Harnesses

RI-300



3" Individual Shoulder Belts and 3" Pull down Lap Belts.
Single Sub Strap.



Bolt- in End



TR-11 TR-12



1" Pull Strap For Easy Adjust

RI-400HART



(2"+3") shoulder belts and 3" lap belts.
Single sub strap.
Shoulder belt with Super light-weight Aluminum adjuster .
Left lap belt with ratchet.



Bolt- in End



or Snap Hook End



TR-11 TR-12



RBS-01



TR-14A

Colours :



RI-500H



(2"+3") Shoulder Belt and 3" Pull down Lap Belts.
Single Sub Strap.



TR-10 / TR-15



1" Pull Strap For Easy Adjust



Bolt-in End



Bolt-in End



Snap Hook End

RI-600



3" Individual Shoulder Belts and 3" Pull down Lap Belts.
Single Sub Strap.
New-Super light weight Latch



Bolt-in End



Snap Hook End



TR-10F TR-15



1" Pull Strap For Easy Adjust

Colours :



FIA & SFI Harnesses

RJ-100



2" Individual Shoulder Belts and 2" Pull up Lap Belts.
Single Sub Strap.



Bolt- in End



TR-11 TR-12

RJ-200



2" Individual Shoulder Belts and 2" Pull up Lap Belts.
Single Sub Strap.
New-Super light weight Latch & Link



Bolt- in End



or Snap Hook End



TR-11F TR-12F



1" Pull Strap For Easy Adjust

Colours :



BI-100

3" Individual Shoulder Belts and 3" Pull down Lap Belts.
with Pad & Sternum Strap.



TR-11 TR-12



Steel Adjuster
With Anti-slip Spring



Bolt- in End

BI-400

3" Individual Shoulder Belts and 3" Pull down Lap Belts.
With Pad & Sternum Strap.
Single Sub Strap.
Shoulder belt with Aluminum Adjuster.



Bolt- in End



or Snap Hook End



TR-11 TR-12



TR-14F

Colours :



FIA & SFI Harnesses

RCU-101



5 POINTS RACING HARNESSSES

Camlock Buckle Type.
3" Individual Shoulder Belts and 3" Pull down Lap Belts.
Single Sub Strap.



Bolt- in End



Aluminium Alloy Camlock Buckle (TB-02)



1" Pull Strap For Easy Adjust

RCU-102



6 POINTS RACING HARNESSSES

Camlock Buckle Type.
3" Individual Shoulder Belts and 3" Pull down Lap Belts.
Double Sub Strap.



Bolt- in End



Fixed End is optional



Steel Adjuster With Anti-slip Spring

Colours :



RCU-1100A



4 POINTS RACING HARNESSES

3" Shoulder Belts and 3" Pull up Lap Belts.
 Snap Hook and 7/16" Eyebolt.
 Ultra-Light Weight Aluminium Adjusters on the Shoulder Belts and Steel Adjusters on the Lap Belts.



Snap Hook End & Eyebolt



Magnesium Alloy Turn Buckle (TB-07)



Fixed End



TR-14A

Colours :



TB-07

New Easy Clip In Turn Buckle (ECI Turn Buckle)

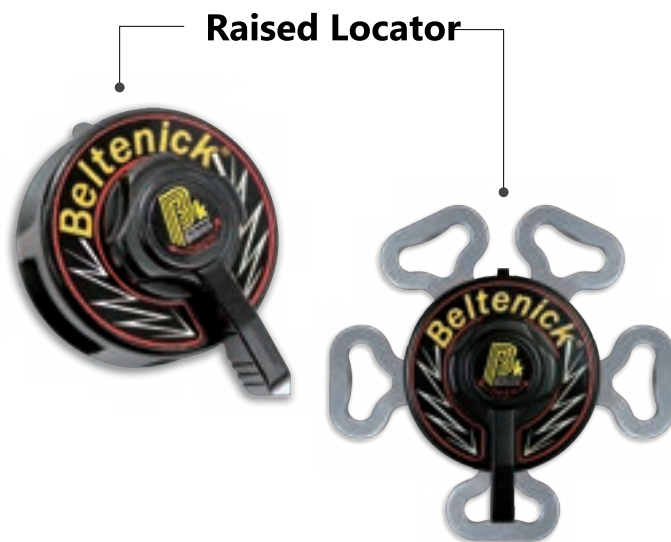

This ECI Buckle Is Equipped at RCU-1100A Series

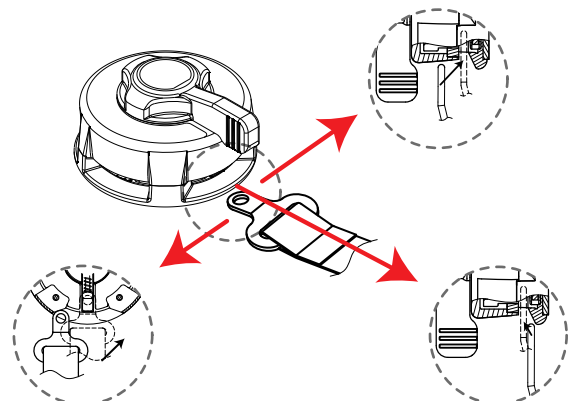

Easy Clip In Instructions



1. Fixed at Right Hand Side

1. To attach the right shoulder strap easily, place your left thumb on the raised locator and clip the belt in.
2. To attach the left shoulder strap, repeat the process using your right thumb on the raised locator and clip the belt in.
3. Clip the link for the left lap belt.
4. Clip the link for the sub strap.



2. Fixed at Left Hand Side

1. To attach the left shoulder strap easily, place your right thumb on the raised locator and clip the belt in.
2. To attach the right shoulder strap, repeat the process using your left thumb on the raised locator and clip the belt in.
3. Clip the link for the left lap belt.
4. Clip the link for the sub strap.



3. Fixed at Sub Strap

1. To attach the right shoulder strap easily, place your left thumb on the raised locator and clip the belt in.
2. To attach the left shoulder strap, repeat the process using your right thumb on the raised locator and clip the belt in.
3. Clip the link for the left lap belt strap.
4. Clip the link for the right lap belt strap.

TB-09

DR(Dual Release) Buckle Ultrafast Dual Direction Release System.

Our new patented Dual Direction Release System, enables fast and easy buckle release. Buckle will now release when turned in either direction with far less effort required. The new raised locator, lever and buckles ergonomic design, ensures fast location and easy operation to release, without the need to look down in an emergency. We believe that this is the safest buckle ever designed.

Pre-release free movement at 40° measured on both sides of the closed position.

Meets FIA 8853-2016 Requirements

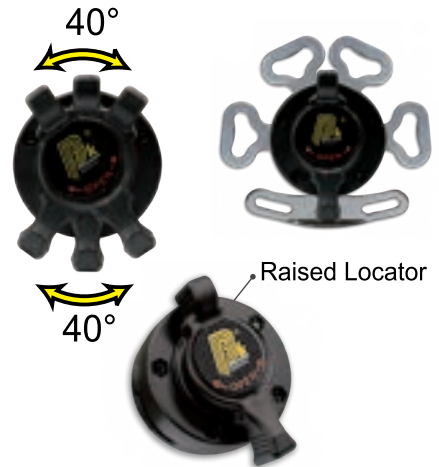

1. Right Hand Side



2. Left Hand Side

NEW R&D Patented

RCU-1002H



FIA 8853-2016 Homologated 6 POINTS RACING HARNESSSES(HANS USE)

(2"+3") Shoulder Belt and 2" Pull Down Lap Belt.
New Quick Release Adjusters on the Shoulder Belts and Steel Adjusters on the Lap Belts.
Snap Hook and 7/16" Eyebolt.
Double Sub Straps.

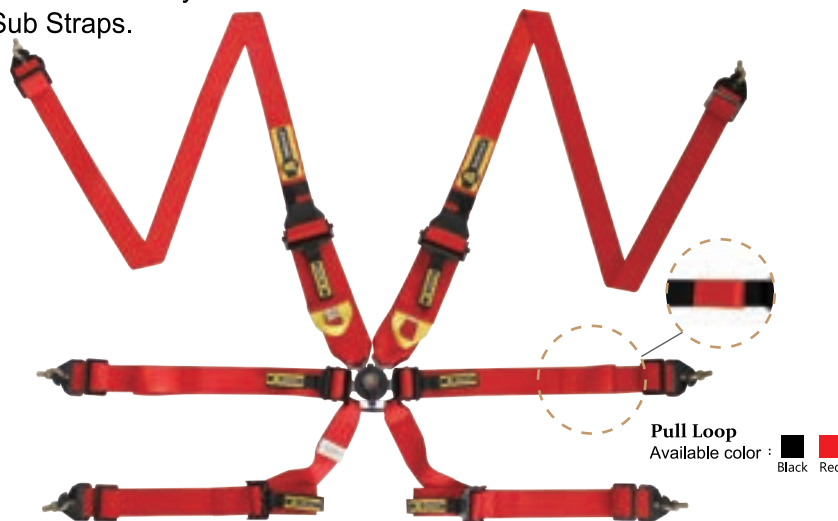

Pull Loop Available color : Black Red

Colours :

New DR Buckle



1" Pull Strap For Easy Adjust



Snap Hook End & Eyebolt



DR Turn Buckle (TB-09)

FIA & SFI Harnesses

RCU-1003



FIA 8853-2016 Homologated 6 POINTS RACING HARNESSSES

3" Shoulder Belt and 3" Pull Up Lap Belt.
New Quick Release Adjusters on the Shoulder Belts and Steel Adjusters on the Lap Belts.
Snap Hook and 7/16" Eyebolt.
Double Sub Straps.



New DR Buckle



Snap Hook End & Eyebolt



DR Turn Buckle (TB-09)



1" Pull Strap For Easy Adjust

RCU-1003H



FIA 8853-2016 Homologated 6 POINTS RACING HARNESSSES(HANS USE)

(2"+3") Shoulder Belt and 3" Pull Up Lap Belt.
New Quick Release Adjusters on the Shoulder Belts and Steel Adjusters on the Lap Belts.
Snap Hook and 7/16" Eyebolt.
Double Sub Straps.



New DR Buckle



Snap Hook End & Eyebolt



DR Turn Buckle (TB-09)



1" Pull Strap For Easy Adjust

Colours :



RCU-1003PD



FIA 8853-2016 Homologated 6 POINTS RACING HARNESSSES

3" Shoulder Belt and 3" Pull Down Lap Belt.
New Quick Release Adjusters on the Shoulder Belts and Steel Adjusters on the Lap Belts.
Snap Hook and 7/16" Eyebolt.
Double Sub Straps.



New DR Buckle



Snap Hook End & Eyebolt



DR Turn Buckle (TB-09)



1" Pull Strap For Easy Adjust

RCU-1004PU



FIA 8853-2016 Homologated 6 POINTS RACING HARNESSSES

FORMULA BELT
2" Shoulder Belt and 2" Pull Up Lap Belt.
Ultra-Light Weight Aluminium Adjuster on the Shoulder Belt and Lap Belt.
Double Sub Straps.



New DR Buckle



Bolt-in End



DR Turn Buckle (TB-09)



1" Pull Strap For Easy Adjust

Colours :



FIA & SFI Harnesses

RCU-1004PD



FIA 8853-2016 Homologated 6 POINTS RACING HARNESSSES

FORMULA BELT
2" Shoulder Belt and 2" Pull Down Lap Belt.
Ultra-Light Weight Aluminium Adjuster on the Shoulder Belt and Lap Belt.
Double Sub Straps.



New DR Buckle



Bolt-in End



DR Turn Buckle
(TB-09)



1" Pull Strap For
Easy Adjust

RCU-1005



FIA 8853-2016 Homologated 6 POINTS RACING HARNESSSES

2" Shoulder Belt and 2" Pull up Lap Belt.
New Quick Release Adjusters on the Shoulder Belt and Steel Adjusters
on the Lap Belt.
Snap Hook and 7/16" Eyebolt.
Double Sub Straps.



New DR Buckle



Snap Hook End
& Eyebolt



DR Turn Buckle
(TB-09)



1" Pull Strap For
Easy Adjust

Colours :



Metal Parts



▲ TB-01



▲ TB-02



▲ TB-03



▲ TB-04



▲ TB-07



▲ TB-09

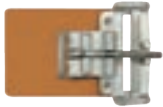

▲ TR-10



▲ TR-10F



▲ TR-11



▲ TR-11F



▲ TR-12



▲ TR-12F



▲ TR-13 (45mm)



▲ TR-13 (50mm)



▲ TR-13A



▲ TR-14



▲ TR-14A



▲ TR-13A



▲ TR-14A



▲ TR-13C (3mm)



▲ TR-13CS (2.5mm)



▲ TR-13D



▲ TR-13E



▲ TR-13F



▲ TR-14E



▲ TR-14F



▲ TR-15



▲ TR-16



▲ TR-17



▲ TR-18



▲ TR-19



▲ TR-20



▲ TR-21



▲ TR-22



▲ TR-23



▲ TR-24A



▲ TR-24C



▲ TR-22-75



▲ TR-23-75



▲ TR-25



▲ TR-25L



▲ TR-26LKTS
▲ TR-26SKTS



▲ TR-26L (50mm)



▲ TR-26S (23mm)



▲ TR-30A



▲ RH-102B



▲ RBS-01



▲ RBS-02



▲ RBS-03



▲ TR-33F



▲ TR-34

Metal Parts

New Era Ultra Lightweight Latch & Link !!

New patented light weight latch and link are made by Precision Progressive Stamping machines.

High tensile alloy steel with heat treated and quenched for highest strength like forging but at much lighter weight than forging.

TR-10 F



TR-10F 3" stamping Latch is at 42% lighter than TR-10 3" forged latch .



Certified

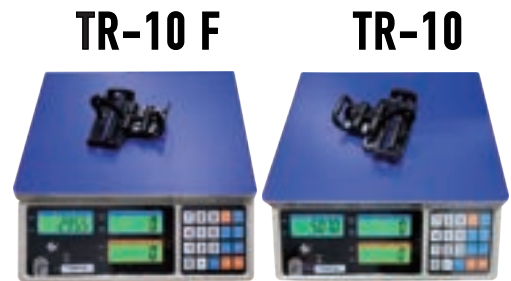

TR-10



	TR-10 F	TR-10
Made by	Stamping	forging
WGT/G	295.5g	507.0g
WGT/lbs	0.651lbs	1.118lbs
Lead time	quick	slow

TR-11 F



TR-11F 2" stamping Latch is at 14% lighter than TR-11 2" forged latch



TR-11

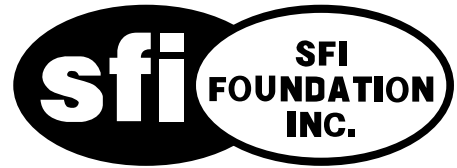

Certified

TR-11 F

TR-11



Made by	Stamping	forging
WGT/G	193.5g	225.0g
WGT/lbs	0.4271lbs	0.496lbs
Lead time	quick	slow

TR-12 F



TR-12F 2" stamping Link is at 31% lighter than TR-12 2" forged link .



TR-12

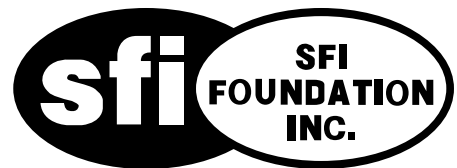

Certified

TR-12 F

TR-12



Made by	Stamping	forging
WGT/G	64.0g	92.5g
WGT/lbs	0.141lbs	0.204lbs
Lead time	quick	slow

Window Net Mounting Kit

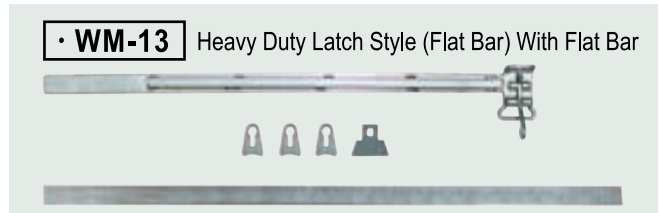
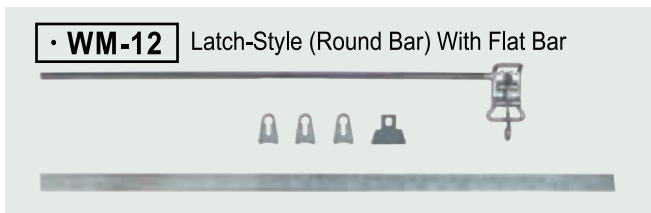
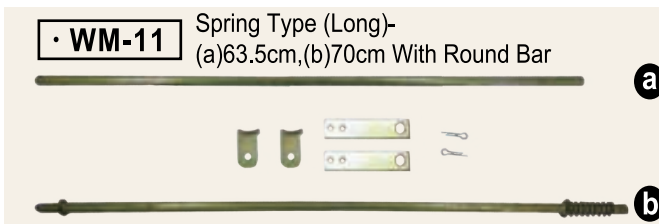
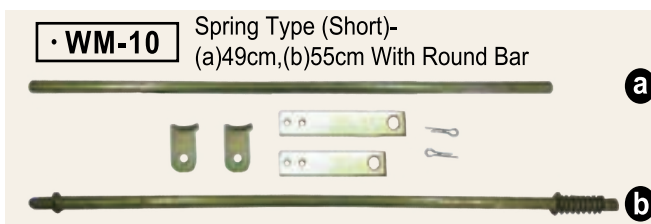
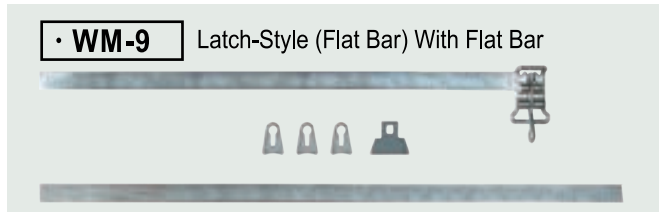
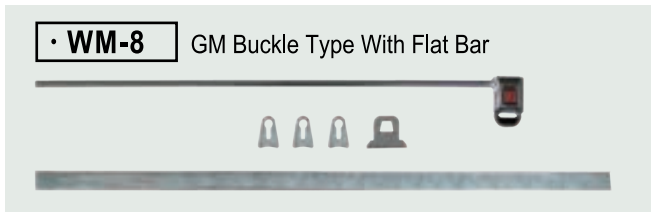
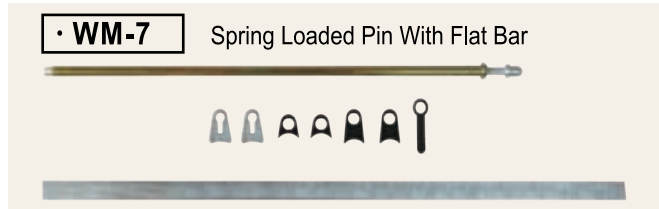
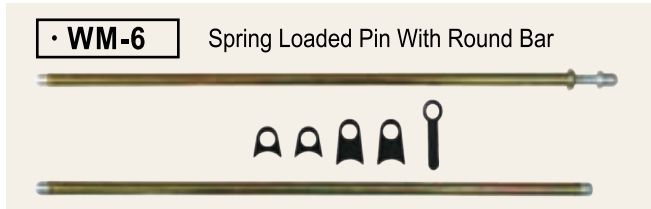

Window Net

Colours :



WN-10 Ribbon Window Net

1" wide webbing and double overlap construction provide a strong durable net.

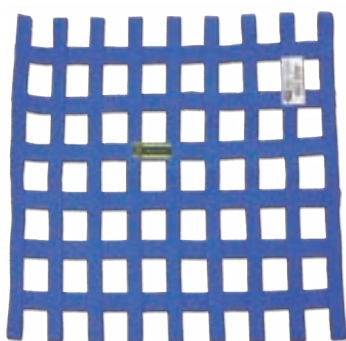

WN-11 Angle Front Net

Similar to the Ribbon Window Net with addition of webbing to match the angle of the A-pillar of the race car.

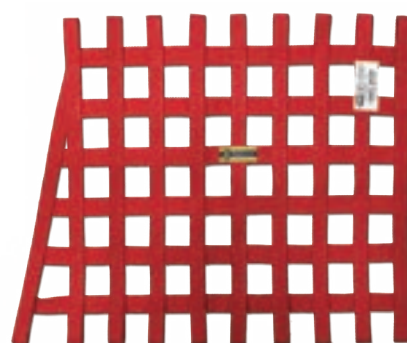

Helmet Net

Beltenick® Rally helmet net.
Keep your expensive rally helmets in good condition with a helmet hammock behind the seats.
Attaches to the roll cage and hold 2 helmets.

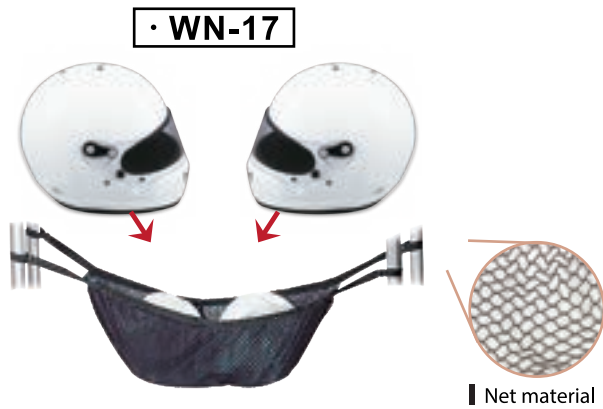

AR-01



Arm Restraint

Colours :
Black Blue Red



Harness Pad

HP-01 Colours :
Black Red



HP-02 Colours :
Black Red



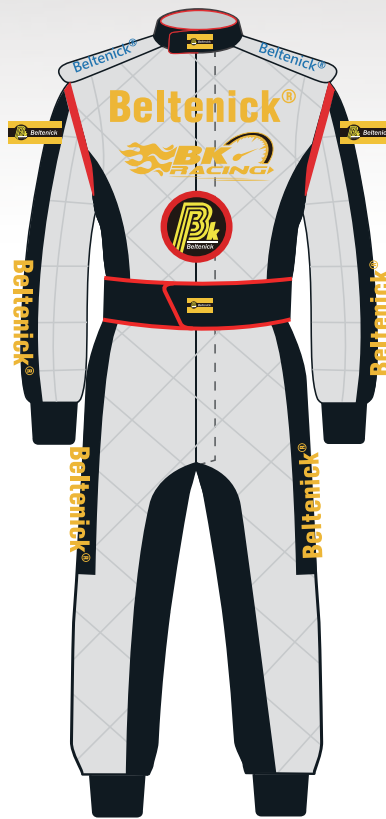
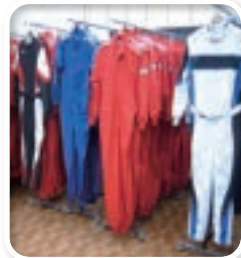
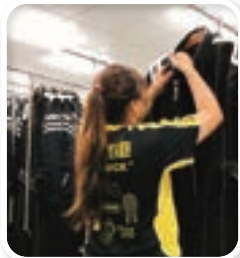
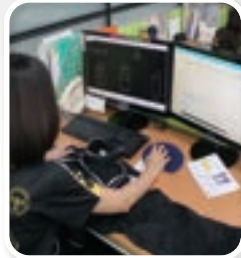
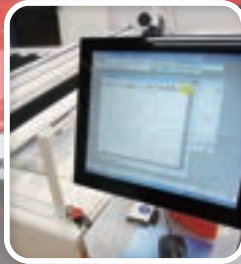
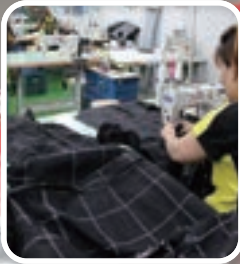

02

Fire Retardant Suit

Fire Retardant Suit

Unlimited fit with ultraflat antirubbing seams, soft knitted fabric inside.

RSN-500A

RSN-500B

RSN-600

RSN-700A

RSN-700B

RS-01

RS-02 / RS-02(2 Pieces)

Aramid Underwear

UW-01 / UW-05 / UW-06

HD-01 / HD-05 / HD-06

SK-02 / SK-03

Helmet Support

HS-01

Gloves

GLN-400 / GLN-500 / GLN-600 / GLN-700

Boots

BTN-400

Fire Retardant Suit

RSN-500A



MANUFACTURER: TRP Co., Ltd.
 MODEL: RSN-500
 HOM. NO: DC.080.20-O
 FIA STANDARD: 8856-2018

Complies With FIA 8856-2018 Homologation Standard.
 3-Layer Nomex® Construction For Enhanced Fire/Heat Protection.
 Close Fitting Suit With Adjustable Belted Waist For Racing Performance.
 Adjustable Collar.
 Shoulder Epaulettes.

Sizes : XS-6XL
 Custom Sizing Available.
 Custom Made Suits Available.
 Colours :



Bi-Colour(Chest in second colour)
 in any combination of above colours.



► Pleats



► Shoulder Epaulette



► Boot Cut Cuff ► Ribbed Knit Cuff

Outer Pocket

Inner pocket is available.



RSN-500A

Elastic Inserts Pleats Design



Fire Retardant Suit

RSN-500B

Complies With FIA 8856-2018 Homologation Standard.
 3-Layer Nomex® Construction For Enhanced Fire/Heat Protection.
 Lumbar Stretch Panel For Unrestricted Movement And Breathability.
 Soft Collar From Knit Nomex.
 Close Fitting Suit With Adjustable Belted Waist For Racing Performance.
 Full Floating Arm Constructed With Knit Fabric For Freedom Of Movement.

Sizes : XS-5XL
 Custom Sizing Available.
 Custom Made Suits Available.

Colours :



Stretch Colours : Black Red White Blue Gray



MANUFACTURER: TRP Co., Ltd.
 MODEL: RSN-500
 HOM. NO: DC.080.20-O
 FIA STANDARD: 8856-2018



► Soft Nomex Knit Collar

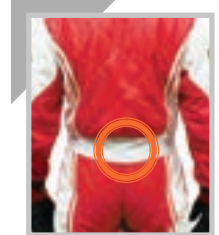

► Stretch Back



► Stretch Arm



★ Classic I



RSN-500B1



★ SVS I



RSN-500B2



★ EMY I



RSN-500B3

Fire Retardant Suit



Shaped Collar

Soft nomex knit collar.

Shoulder Epaulette

Stretch Arms & Back

With elastic knitted fabric for freedom of movement.



Inner Pocket

Outer pocket is available.

Inner Cuffs (Nascar)

Inner Pocket

Outer pocket is available.

★
STL II



RSN-500B5

★
SPL III



RSN-500B6

★
STL I



RSN-500B4

Fire Retardant Suit

RSN-600



MANUFACTURER: TRP Co., Ltd.
MODEL: RSN-600
HOM. NO: DC.210.22-O
FIA STANDARD: 8856-2018

Advanced Light Weight Nomex Fabrics & Inner Knit.

Complies With FIA 8856-2018 Homologation Standard.
360° Fully Floating Sleeves & Stretch Back.
Highly Breathable.

Sizes : XS-5XL

Custom Sizing Available.

Custom Made Suits Available.

Colours : Black Red White Blue Gray Dark Gray Dark Green



RSN-600

360° Fully floating sleeves & stretch back.



► Stretch Arm



► Stretch Back



► Shoulder Epaulette

Stretch Colours :

Black Red White Blue Gray

Inner Pocket

Outer pocket is available.

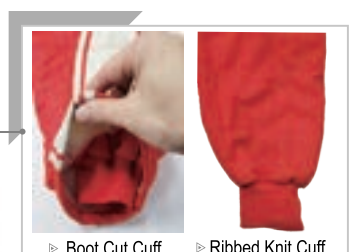

► Boot Cut Cuff ► Ribbed Knit Cuff



SVS II

Yellow/Black



RSN-600B

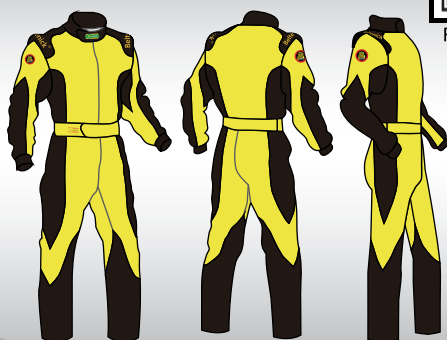

Classic II

Fire Retardant Suit

RSN-700A

NEW
PRODUCT

RSN-700B

Brand New Total Printing Suit Stylish With No Boundaries

3-Layer Nomex® Construction For Enhanced Fire / Heat Protection.
Close Fitting Suit With Adjustable Belted Waist For Racing
Performance.

Soft Collar From Knit Nomex.

Available for both Outer Cuffs and Inner Cuffs(Nascar)

Sizes : XS-6XL

Custom Sizing Available.

Custom Made Suits Available.



▶ Pleats

Inner Pocket



▶ Elastic Inserts



▶ Soft Nomex Knit Collar



▶ Stretch Back



▶ Stretch Arm



▶ Boot Cut Cuff

▶ Ribbed Knit Cuff

Customize your racing apparel

Unlimited customization allows you to show off your stylish design. Just send us your design by AI format then we would make your total printing custom apparel. Don't hesitate any longer and contact us for detailed information.

Fire Retardant Suit

RS-01



Certified

Fire Retardant Racing Suits
Single Layer Fire Retardant Racing Suit,
SFI 3.2A/1 Rating

Sizes : XS-6XL
Custom Sizing Available.
Custom Made Suits Available.

Colours :  Black  White  Gray  Blue  Red  Yellow

Elastic Inserts

Shoulder Epaulette

Pleats Design

Inner Pocket

Outer pocket is available.



★ **Standard II**

★ **SPL I**

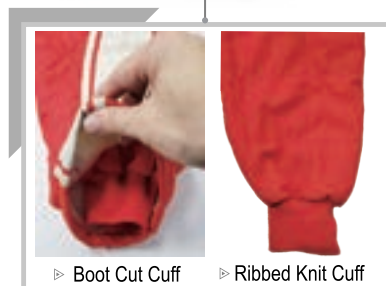

▶ Boot Cut Cuff

▶ Ribbed Knit Cuff

Fire Retardant Suit



Certified

RS-02

Fire Retardant Racing Suits
Two Layers Fire Retardant Racing Suits,
SFI 3.2A/5 Rating

Sizes : XS-6XL

Custom Sizing Available.

Custom Made Suits Available.

Colours :



★ Standard X

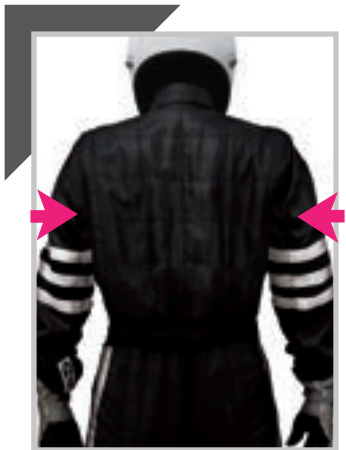

▷ Pleats



▷ Shoulder Epaulette

Fire Retardant Suit

Beltenick®

RS-02 [2 pieces]



Certified

Fire Retardant Racing Suits
Two Layers Fire Retardant Racing Suits,
SFI 3.2A/5 Rating

Sizes : XS-2XL
Custom Sizing Available.
Custom Made Suits Available.
Colours :



Shoulder Epaulette

Standard V

Aramid Underwear

Aramid Underwear UW-01/UW-06

Complies with FIA 8856-2018 homologation standard.

Made from single layer Silk Touch Nomex®.
Beltenick® underwear is offering best value for money.
Sizes : 2XS-4XL

- **UW-01 : 100% Aramid**

Colours :    
Black White Blue Red



- **UW-06 : 100% Aramid**

Colours :  
Black Natural



SFI Underwear UW-05

Complies with SFI 3.3 homologation standard.

Beltenick® underwear is offering best value for money.
Sizes : 2XS-4XL

- **UW-05 : 60%MODACRYLIC
40%CELLULOSE FIBER**





Colours :  
Black Natural



HD-01

Single/Double Layers Balaclavas

HD-01 : 100% Aramid

Colours :    
Black White Blue Red



HD-05

Single/Double Layers Balaclavas

HD-05 : 60%MODACRYLIC
40%CELLULOSE FIBER

Colours :  
Black Natural



HD-06

Double Layers Balaclavas

HD-06 : 100% Aramid

Colours :  
Black Natural



SK-02



Helmet Support HS-01

SK-03



Socks Sizes : S/M/L/XL

Colours :  
Black Natural

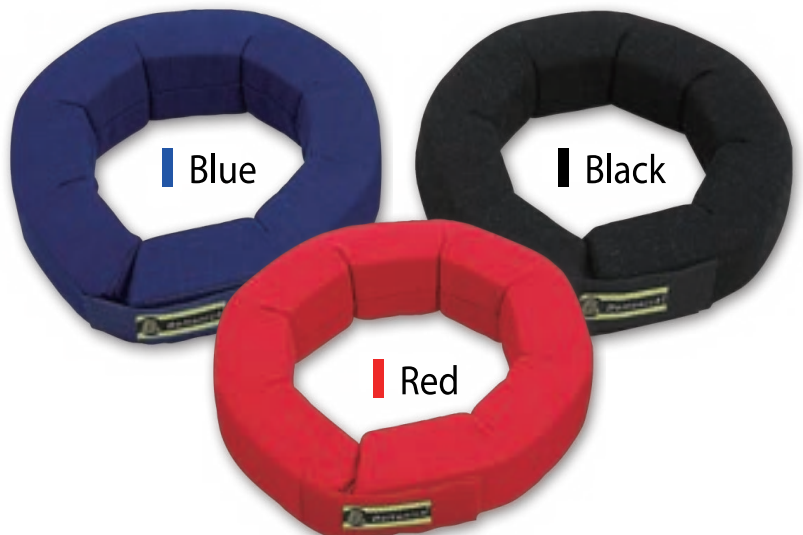

S=10cm/3.94" M=12cm/4.72" L=15cm/5.91"

Gloves

GLN-400



Certified

GLN-500



MANUFACTURER: TRP Co., Ltd.
MODEL: GLN-500
HOM. NO.: DC.008.19-G
FIA STANDARD: 8856-2018

FIA 8856-2018 and SFI 3.3 approved with all Nomex construction and improved fit. Internal seam.

Sizes : XS-2XL

Colours : Black White Blue Red



Red/Black



Blue/Black



Black/White

GLN-400 / GLN-500

Size	(A) Palm circumference	(B) Hand Length
XS	18cm	18cm
S	19cm	19cm
M	20cm	20cm
L	21cm	20cm
XL	22cm	21cm
2XL	23cm	22cm

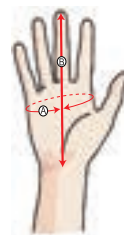

GLN-600



FIA 8856-2018 approved with all Nomex construction and improved fit.
External seam construction maximum comfort and feel.

Sizes : XS-3XL

Colours :     
Black Red White Blue Silver



White/Silver



Blue/Black



Black/White



Red/Black

GLN-600



Size	(A) Palm circumference	(B) Hand Length
XS	18cm	18cm
S	19cm	19cm
M	20cm	20cm
L	21cm	20cm
XL	22cm	21cm
2XL	23cm	22cm
3XL	24cm	24cm

Gloves

GLN-700

NEW
PRODUCT

Featuring Conductive Print Totally Pintable Design

This premium racing glove is applied to a touch-compatible print on the thumb and index fingers for mobile devices use. The thumb and index fingers feature half internal and half external seams for providing an excellent feel while holding the steering wheel.



BTN-400



Fire Resistant Racing Shoes

Suede leather lined in soft Nomex fire retardant knit fabric.

Molded rubber sole resistant to hydrocarbons.

Sizes : EURO #34-#50

Colours : Black White Blue Red

BTN-400

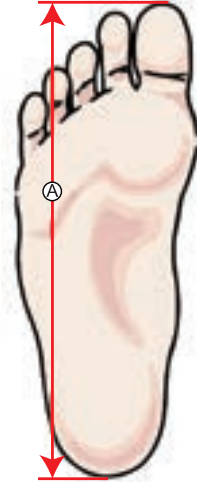

	Euro	US	(A)Foot Length (cm)
	34	2.5	20.5
	35	3.5	21.5
	36	4.5	22.5
	37	5	23
	38	6	24
	39	7	25
	40	7.5	25.5
	41	8.5	26.5
	42	9	27
	43	10	28
	44	10.5	28.5
	45	11.5	29.5
	46	12	30
	47	13	31
	48	14	32
	49	14.5	32.5
	50	15	33



• Red/Black



• Blue/Black



• White/Black



• Black/Black



• Black/Red



• Black/White



• Black/Blue

Production under the same roof

GLOVES



BOOTS



SEATS



STEERING WHEEL



HELMET



03



Seats

Seats

RST-300 / RST-500 /
RST-600 / RST-700 /
RST-800 / RST-900 /
RST-1100 / RST-1200 /
UTV-100 / SSM-01 /
SSM-02 / SSM-03 /
SSM-04 / ASM-01

Seats

RST-300



Professional Racing Seat.

- Preformed thigh support to keep legs in the optimum position and special shock absorbing material in the head and side areas.
- Filler : superior memory foam.
- Tubular steel frame with side and bottom fixing points.
- Belt guides for a 4 or 6 point belt.
- FIA Homologation 8855-1999.
- Covers : Velvet, Artificial leather, Mesh Fabric.
- Colours : Black Blue Red

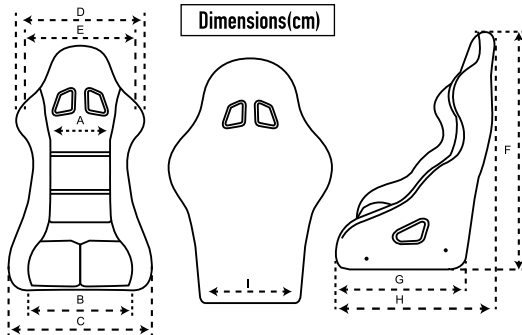

A	B	C	D	E	F	G	H	I
36	37	51	60.5	53	89.5	46	57.5	41

RST-500



Professional Racing Seat. Carbon Fiber Racing Seat.

- One-piece design ensure that the speed racer would feel safety and comfortable when driving, and it also can be a very good driver protection.
- Preformed thigh support to keep legs in the optimum position and special shock absorbing material in the head and side areas.
- Filler : superior memory foam.
- Monolithic construction of high durability.
- Carbon fiber reinforced plastic shell mould.
- Belt guides for a 4 or 6 point belt.
- FIA Homologation 8855-1999.
- Covers : Velvet, Artificial leather, Mesh Fabric.
- Colours : Black Blue Red

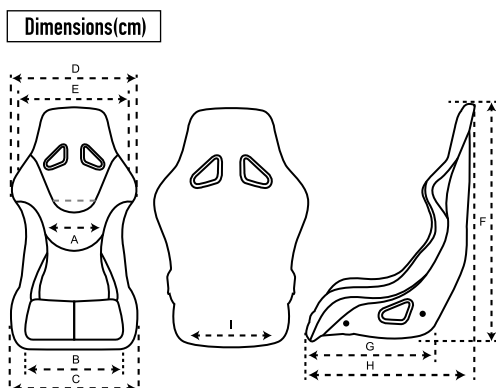

A	B	C	D	E	F	G	H	I
31	35	51	54.5	45	92	45.5	64	40

RST-600



Professional Racing Seat. Glass Fiber Racing Seat.

- One-piece design ensure that the speed racer would feel safety and comfortable when driving, and it also can be a very good driver protection.
- Preformed thigh support to keep legs in the optimum position and special shock absorbing material in the head and side areas.
- Filler : superior memory foam.
- Monolithic construction of high durability.
- Glass fiber reinforced plastic shell mould.
- Belt guides for a 4 or 6 point belt.
- FIA Homologation 8855-1999.
- Covers : Velvet, Artificial leather, Mesh Fabric.
- Colours : Black Blue Red

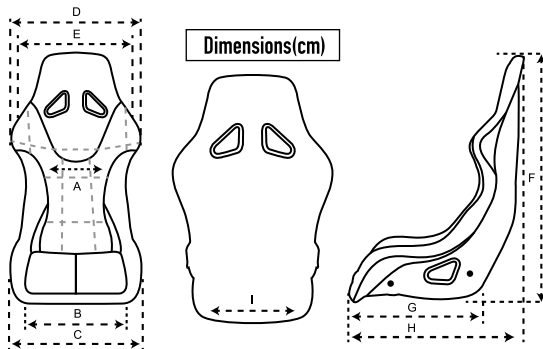

A	B	C	D	E	F	G	H	I
31	35	51	54.5	45.5	92	45.5	64	40

RST-700



Professional Racing Seat. Glass Fiber Racing Seat.

- One-piece design ensure that the speed racer would feel safety and comfortable when driving, and it also can be a very good driver protection.
- Preformed thigh support to keep legs in the optimum position and special shock absorbing material in the head and side areas.
- Filler : superior memory foam.
- Monolithic construction of high durability.
- Glass fiber reinforced plastic shell mould.
- Belt guides for a 4 or 6 point belt.
- FIA Homologation 8855-1999.
- Covers : Velvet, Artificial leather, Mesh Fabric.
- Colours : Black Blue Red

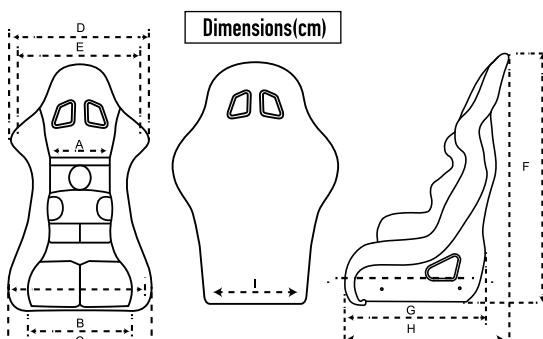



A	B	C	D	E	F	G	H	I
34	42.5	53	60.5	50.5	89.5	51	68	42

Seats

RST-800



Professional Racing Seat. Glass Fiber Racing Seat.

- One-piece design ensure that the speed racer would feel safety and comfortable when driving, and it also can be a very good driver protection.
- Preformed thigh support to keep legs in the optimum position and special shock absorbing material in the head and side areas.
- Filler : superior memory foam.
- Monolithic construction of high durability.
- Glass fiber reinforced plastic shell mould.
- Belt guides for a 4 or 6 point belt.
- FIA Homologation 8855-1999.
- Covers : Velvet, Artificial leather, Mesh Fabric.
- Colours :  Black  Blue  Red

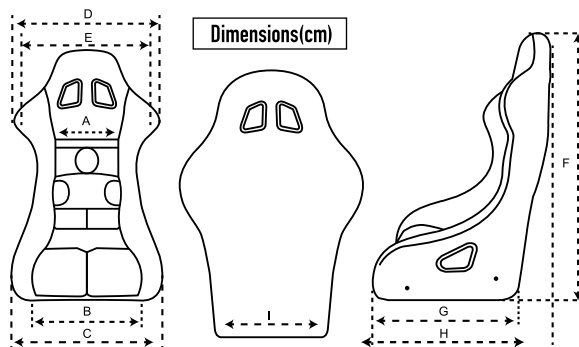



A	B	C	D	E	F	G	H	I
36	45	58	61	53	94	52	59	44



RST-900



Professional Racing Seat. Glass Fiber Racing Seat.

- Large head and shoulder protections.
- One-piece design ensure that the speed racer would feel safety and comfortable when driving, and it also can be a very good driver protection.
- Preformed thigh support to keep legs in the optimum position and special shock absorbing material in the head and side areas.
- Filler : superior memory foam.
- Monolithic construction of high durability.
- Glass fiber reinforced plastic shell mould.
- Belt guides for a 4 or 6 point belt.
- FIA Homologation 8855-1999.
- Covers : Velvet, Artificial leather, Mesh Fabric.
- Colours :  Black  Blue  Red

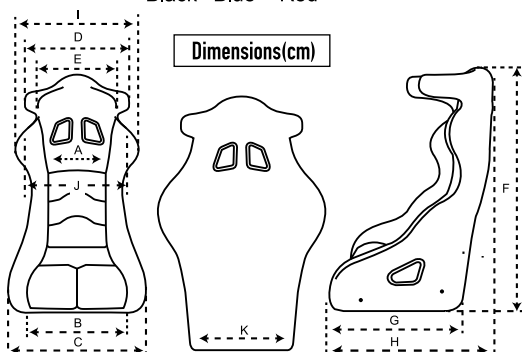

A	B	C	D	E	F	G	H	I	J	K
39	43	53.5	53	37	94	51	60	61	53	42



RST-1100



MANUFACTURER: TRP Co., Ltd.
MODEL: RST-1100
HOM. NO: CS.457.20
FIA STANDARD: 8855-1999

Professional Racing Seat. Carbon Fiber Racing Seat.

- One-piece design ensure that the speed racer would feel safety and comfortable when driving, and it also can be a very good driver protection.
- Preformed thigh support to keep legs in the optimum position and special shock absorbing material in the head and side areas.
- Filler : superior memory foam.
- Monolithic construction of high durability.
- Carbon fiber reinforced plastic shell mould.
- Belt guides for a 4 or 6 point belt.
- FIA Homologation 8855-1999.
- Covers : Velvet, Artificial leather, Mesh Fabric.
- Colours : Black Blue Red

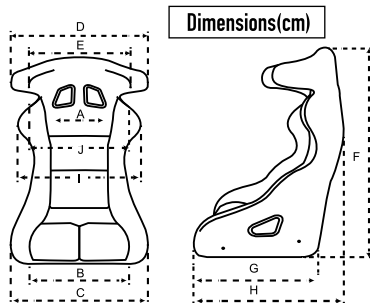

A	B	C	D	E	F	G	H	I	J
36	37	50	56	45.5	93.8	54	61	62	54

RST-1200



MANUFACTURER: TRP Co., Ltd.
MODEL: RST-1200
HOM. NO: CS.013.23
FIA STANDARD: 8855-2021

Professional Racing Seat. Glass Fiber Racing Seat.

- Large head and shoulder protections.
- One-piece design ensure that the speed racer would feel safety and comfortable when driving, and it also can be a very good driver protection.
- Preformed thigh support to keep legs in the optimum position and special shock absorbing material in the head and side areas.
- Filler : superior memory foam.
- Monolithic construction of high durability.
- Glass fiber reinforced plastic shell mould.
- Belt guides for a 4 or 6 point belt.
- FIA Homologation 8855-2021.
- Covers : Velvet, Artificial leather, Mesh Fabric.
- Colours : Black Blue Red

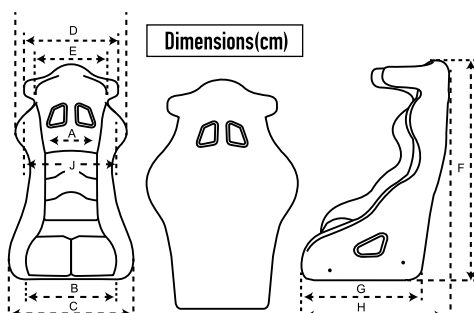

A	B	C	D	E	F	G	H	I	J
30	37.5	49	49.5	34.5	99	51	59	64	54

UTV-100

Professional Racing Seat.

- Covered with Durable Vinyl, resistance to UV fading.
- Vinyl are waterproof and easy to clean.
- High resiliency foam.
- Three-quarter tubing with expertly welded.

Colours : 
 Black Blue Red Orange White

Dimensions(cm)

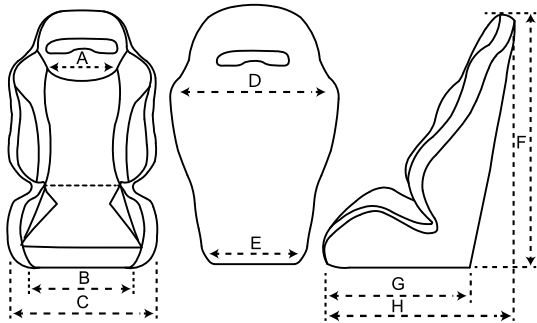

A	B	C	D	E	F	G	H
34	42.5	60.5	50.5	89.5	51	68	42

Custom Design Printing Available !!

Make your own design here
for your seats .

Put your unique design on the seat
to be different from others .

Just send your AI format then
you will have your custom seat.



Seat Mount

FIA APPROVED



SSM-01

• SSM-01 Seat Mount Universal High-Pair

Product Details

Steel seat mounts 125mm tall specifications :

- Seat mounting slots center to center : 290mm
- Seat mounting hole size : one end 15L x 10H mm
other end 9mm diameter hole
- Finish : Black Epoxy
- Dimensions : 360L x 55W x 125H mm
- Weight : 2.5kg



SSM-02

• SSM-02 Seat Mount Universal Low-Pair

Product Details

Steel seat mounts 110mm tall specifications :

- Seat mounting slots center to center : 290mm
- Seat mounting slot size : one end 18L x 9H mm
- Finish : Black Epoxy
- Dimensions : 390L x 68W x 112H mm
- Weight : 1.72kg



SSM-03

• SSM-03 Seat Mount Universal High-Pair

Product Details

Steel seat mounts 160mm tall specifications :

- Seat mounting slots center to center : 290mm
- Seat mounting hole size : one end 18L x 9H mm
other end 15L x 9H mm
- Finish : Black Epoxy
- Dimensions : 360L x 58W x 160H mm
- Weight : 2.28kg

FIA APPROVED

MANUFACTURER: TRP Co., Ltd.
MODEL: SSM-04
HOM. NO: CS-013.23
FIA STANDARD: 8855-2021



SSM-04

• SSM-04 Seat Mount Universal High-Pair

Product Details

Steel seat mounts 245mm tall specifications :

- Seat mounting slots center to center : 290mm
- Seat mounting hole size : one end 26L x 13H mm
other end 19L x 13H mm
- Finish : Black Epoxy
- Dimensions : 469L x 40W x 245H mm
- Weight : 5.3kg



ASM-01

• ASM-01 Alloy Seat Mount Tall 125mm-Pair

Product Details

Alloy seat mounts 125mm tall specifications :

- Seat mounting slots center to center : 290mm
- Seat mounting slot size : 15L x 10H mm
- Finish : Black Epoxy
- Dimensions : 400L x 50W x 125H mm
- Weight : 1.5kg

04



Steering Wheel

Steering Wheel
DR-100 / DR-101 / DR-102
QR-100

Steering Wheel

Steering Wheel DR-100

Hotsale 350mm Suede Leather/Deep Dish Steering Wheel

Material : Genuine suede leather, PU
 Spoke Material : Aluminum (5mm thickness)
 Diameter : 350mm / 14inch
 Application : Off Road Racing Car
 Depth : 72mm

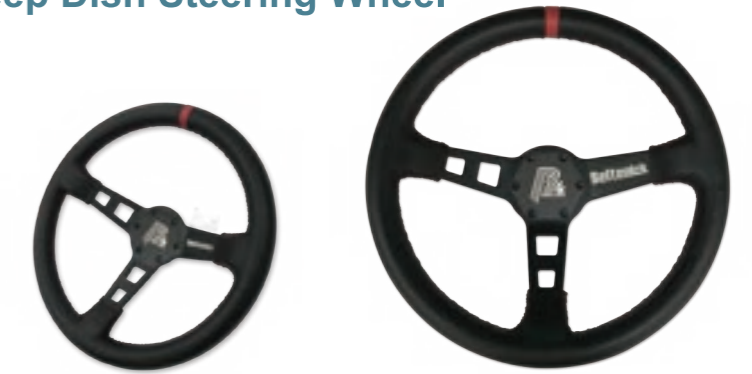
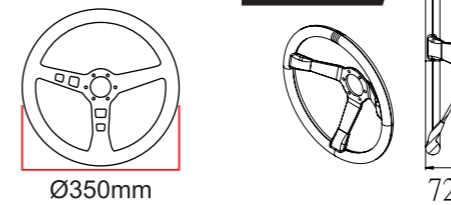

Steering Wheel DR-101

Hotsale 350mm Suede Leather/Flat Dish Steering Wheel

Material : Genuine suede leather, PU
 Spoke Material : Aluminum (5mm thickness)
 Diameter : 350mm / 14inch
 Application : Off Road Racing Car
 Depth : 33mm

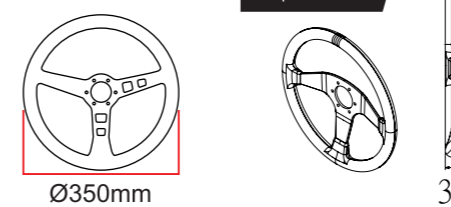

Steering Wheel DR-102

Material : Genuine suede leather, PU
 Spoke Material : Aluminum (5mm thickness)
 Application : Off Road Racing Car
 Depth : 42mm

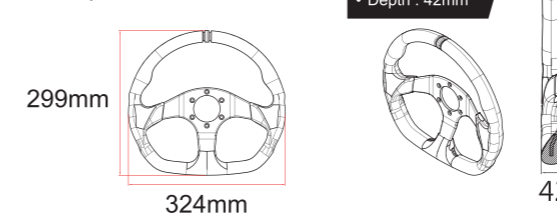

Quick Release QR-100

Quick Release Snap Off Hub Boss Kit

Material : Aluminum
 Overall Diameter : 99mm / 87.5mm
 Overall Height : 99.4 mm

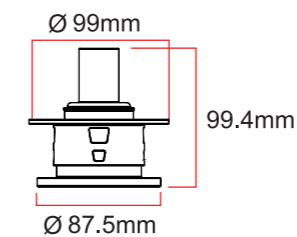

CATALOG

Original Manufacturer 03

Racing Harnesses 05

FIA & SFI Harnesses 07

- RI-100 / RI-100A / RI-100SH / RI-200 / RI-300 / RI-400HART
- RI-500H / RI-600 / RJ-100 / RJ-200 / BI-100 / BI-400
- RCU-101/ RCU-102 / RCU-1100A / TB-07 / TB-09 / RCU-1002H / RCU-1003
- RCU-1003H / RCU-1003PD / RCU-1004PU / RCU-1004PD / RCU-1005

Metal Parts 20

- TB-01 / TB-02 / TB-03 / TB-04 / TB-07 / TB-09
- TR-10 / TR-10F / TR-11 / TR-11F / TR-12 / TR-12F / TR-13(45mm)
- TR-13(50mm) / TR-13A / TR-14 / TR-14A / TR-13A / TR-14A / TR-13C(3mm)
- TR-13CS(2.5mm) / TR-13D / TR-13E / TR-13F / TR-14E / TR-14F / TR-15
- TR-16 / TR-17 / TR-18 / TR-19 / TR-20 / TR-21 / TR-22
- TR-23 / TR-24A / TR-24C / TR-22-75 / TR-23-75 / TR-25 / TR-25L / TR-26LKTS
- TR-26SKTS / TR-26L / TR-26S / TR30A / RH-102B / RBS-01 / RBS-02 / RBS-03
- TR-33F / TR-34

Window Net Mounting Kit

WM-6 / WM-7 / WM-8 / WM-9 / WM-10 / WM-11 / WM-12 / WM-13 23

Window Net

WN-10 / WN-11

Helmet Net / Arm Restraint / Harness Pad 24

WN-17 / WN-21

AR-01

HP-01 / HP-02