



SERVICE & OVERHAUL



RACING & PERFORMANCE



Brendan Murry, Nostalgia Top Fuel

Six world championships, 62 wins, two-time Indy winner, 1998 California Hot Rod Reunion winner. Nitronic Research 5 Second Club, Good Guys Rod & Custom 5 Second Club.

AJPE/TFX 396" Fuel Hemi, sealed by SCE Gaskets for over 10 years.

Tim Wilkerson, NHRA Fuel Funny Car

Tim began racing his Fuel Coupe' in 1996, since that time he's amassed 17 Event wins and multiple top ten championship seasons. One of the few Owner-Tuner-Drivers in the NHRA Fuel ranks he knows exactly what he needs to win. Dependable parts. Tim uses SCE Gaskets.



Terry & Lori McCarl, TMAC Motorsports #24 World of Outlaws Sprint Car

44 wins in the National World of Outlaws Series since 2008, seven-time Knoxville champion, seven-time Husets Speedway champion, World Series Sprintcar winner, Warnambool, Victoria, Australia.

900 Horsepower, 410ci Chevrolet on methanol, sealed by SCE Gaskets.

On the Cover: Clint Hairston on a sub-6-second pass in his Pro Street GTO powered by a Duttweiler 3000hp 396" Twin Turbo Small Block, sealed by SCE Gaskets.

Engine Master Gasket Sets

For Service & Overhaul

SCE's new Engine Master kit sets feature Made in USA gaskets and components. You can rest easy, knowing you have all the gaskets and seals for the job, with the savings and convenience of a full gasket set!



NEW
SEE PAGE
73

Precision-Molded Carb Gaskets

Molded metering block and float bowl gaskets for Holley style carburetors
 — Part number listing on page 69 —

Technology Meets Carburetor Gaskets

- Jetting changes just got quicker & easier
- Super-tough molded gaskets
- Won't tear or stick
- Eliminates scraping
- Completely reusable

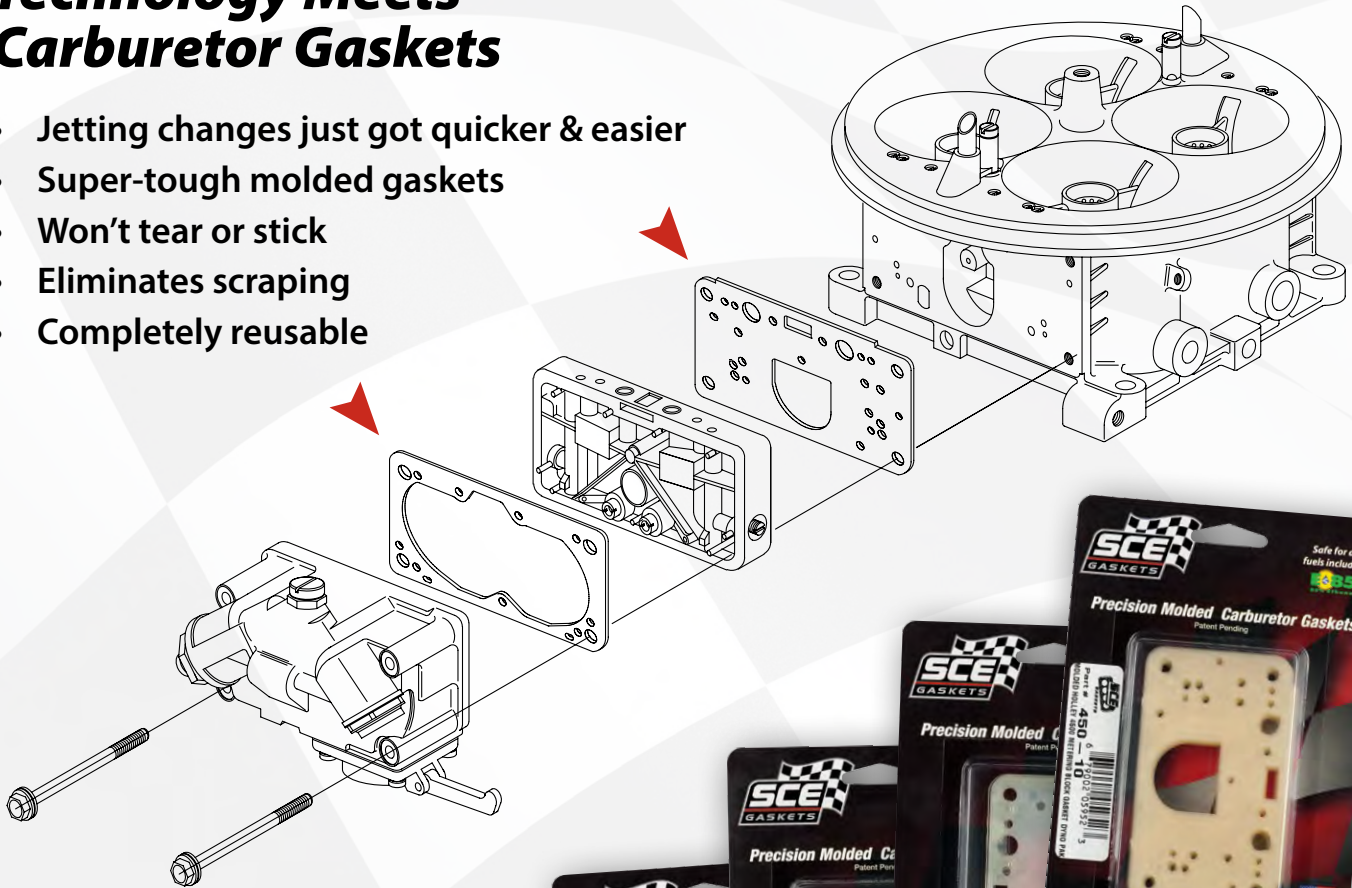

- Precision fuel and air passages for better consistency.
- Non-stick thermoplastic material resistant to all motor fuels, racing fuels and additives common to racing.
- Will not shrink, so float bowl screws stay tight.
- Strong, tear-proof and reusable.



**MADE in the USA
 by SCE GASKETS**

WON'T SHRINK • WON'T STICK • WON'T TEAR

Superior Technology Delivers Performance Under Pressure

Coolant and Oil Seals on Titan and ICS Titan™ Head Gaskets

Patented coolant and oil seals are designed to work with minimal clamp load. As seen in the section view, these seals are offset rather than stacked to accomplish two important objectives. First, the compressive load of tightening head bolts forces the seals toward the center of the annealed gasket body to form containment channels which help prevent seal blowout. Second, fully compressed coolant and oil seals lie in a single plane with the gasket body, thereby "tripping" additional clamp load to the combustion seal, allowing for increased cylinder sealing. This is true of both Titan and ICS Titan head gaskets.

ICS Titan™

Built-in combustion seals block lateral flow of combustion pressure.

Images show wire o-ring primary seal and self-energizing secondary combustion pressure seal.

Combustion Seals on ICS Titan Head Gaskets

Patented Integral Combustion Seals found only on ICS Titan head gaskets take the place of o-ringed blocks or heads, with an added benefit. The illustration shows how the solid gasket body is separated for insertion of a stainless o-ring wire. Primary combustion sealing is achieved by load concentration from the inserted wire, as in the case of an o-ringed block. In addition, the upper and lower flanges of the ICS combustion seal remain open toward the cylinder, allowing the pressure of combustion to force them against the block and head. Extreme cylinder pressure can cause the head to lift; in this case, the upper and lower flanges of the ICS seal follow the head and block, providing an additional, secondary combustion gas seal. Best of all, there is *no machining required!*

FIND THEM HERE in Head Gaskets
near the end of each engine section.

Head Gaskets

Application	Gasket Style	Bore	.021"	.032"	.043"	.050"	.062"	.072"	.080"	.093"
350-455 Oldsmobile and aftermarket blocks	Pro Copper	requires o-rings & sealant	079202	079203	079204	079205	079206	079207	079208	079209
	Titan	requires o-rings	4.200	T79203	T79204	T79205	T79206	T79207	T79208	T79209
	ICS Titan	ready to use		S79204	S79205	S79206	S79207	S79208	S79209	
Packaged in Pairs	Pro Copper	requires o-rings & sealant	079252	079253	079254	079255	079256	079257	079258	079259
	Titan	requires o-rings	4.250"	T79253	T79254	T79255	T79256	T79257	T79258	T79259
	ICS Titan	ready to use		S79254	S79255	S79256	S79257	S79258	S79259	
Packaged in Pairs	Pro Copper	requires o-rings & sealant	079322	079323	079324	079325	079326	079327	079328	079329
	Titan	requires o-rings	4.320"	T79323	T79324	T79325	T79326	T79327	T79328	T79329
	ICS Titan	ready to use		S79324	S79325	S79326	S79327	S79328	S79329	
Packaged in Pairs	Pro Copper	requires o-rings & sealant	079382	079383	079384	079385	079386	079387	079388	079389
	Titan	requires o-rings	4.380"	T79383	T79384	T79385	T79386	T79387	T79388	T79389
	ICS Titan	ready to use		S79384	S79385	S79386	S79387	S79388	S79389	

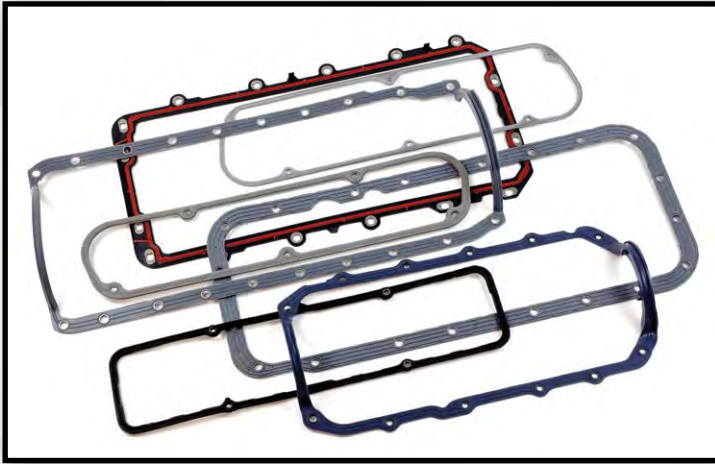

Molded Rubber Oil Pan & Valve Cover Gaskets

SCE Gaskets offers state of the art molded silicone rubber gaskets for all popular oil pan and valve cover applications. These gaskets offer one-piece construction to eliminate frustrating leaks at the four corners of the oil pan, and they're re-usable! SCE one-piece pan and valve cover gaskets are constructed of the highest grade silicone rubber to resist heat damage and seal irregularities in the sealing surfaces. Each gasket has built-in crush limiters to prevent damage from over-tightening.

FIND PAN GASKETS HERE in Short Block Gaskets and Seals at the beginning of each engine section.

Short Block Gaskets and Seals

Application	Qty	Oil Pan Gasket	Front Cover Gaskets TC, WP, FP	Water Pump	Timing Cover Seal	Timing Cover Set	Rear Main Seal	Fuel Pump	Water Outlet
Mark IV 1965-90		Rubbered Fiber					Silicone		
Accu Seal E	Each	13090-10	11300	11301	11302	11303	11305	11306	11308
Dyno Pak	10 pak	13090-10	1300-10	1301-10	1302-10		1305-10	1306-10	1308-10
Accu Seal Pro	Each	1pc Molded 213090			Viton® 21302		Viton® 21305		Molded 21108
Dyno Pak	10 pak	213090-10			21302-10		21305-10		

FIND VALVE COVERS HERE on the first page of each engine section.

Valve Cover Gaskets

Application	Qty	Cork, Hi Density 5/16" Thick Street/Strip	Laminated Silicone Cork 1/8" Thick Racing/Hi Vacuum	Laminated Silicone Cork 1/4" Thick Racing/Hi Vacuum	Molded Silicone Rubber Street Performance	Alcohol Resistant Fiber .062" Thick Sportsman Racing	Steel Core Teflon Coated .078" Thick Severe Duty
Big Chevrolet all 3 over 5 bolt pattern	1pr	113076	213075	213076	213077	213079	213078
Dyno Pak	10pr	13076-10	213075-10	213076-10	213077-10	213079-10	213078-10



Performance Head Gaskets

for AMC, Chrysler, Ford & GM Muscle Cars

SCE Pro Seal composite head gaskets are the ideal solution for the performance aftermarket. Strong and easy to use, SCE performance head gaskets are manufactured with the right combination of materials and features for easy and dependable use on real-world, high compression, street/strip power plants.

FEATURES

- Compressible body construction
- Self - Sealing coating
- Silicone Bead Seals (where required)
- Extra Thick Fire Rings

BENEFITS

- Accepts Standard Surface Finish
- No need for additional sealants and no leaks
- Enhanced coolant sealing
- Stronger Combustion Seal

Embossed Steel Shim Head Gaskets

SCE re-introduces classic steel shim head gaskets for high compression use. Stock Eliminator and Super Stock class rules do not allow machining to install o-rings for copper head gaskets. Consequently, racers in these classes use steel shim head gaskets for strength and to 'pump up' their compression ratios. Over the last several years embossed steel shim head gaskets have been hard to find, until now. Super thin, super strong OEM style shim steel head gaskets are once again available for select performance applications.



FIND THEM HERE near the end of each engine section.

Composite Head Gaskets

Application	Gasket Construction	Bore	Qty.	Compressed Thickness		
				.015"	.039"	.060"
1955-97 SBC except LT-1/LT-4 reverse flow. Performance applications up to 15 lbs boost or 100 shot nitrous.	Embossed Steel Shim	4.100"	1 each	511101		
	Dyno Pak		10 each	511101-10		
	Stainless / Graphite Composite	4.140"	1 each		511144	511146
	Dyno Pak		10 each		511144-10	511146-10
	Stainless / Graphite Marine	4.140"	1 each		611144	611146
	Dyno Pak		10 each		611144-10	611146-10
Stainless / Graphite Composite	4.200"	1 each		511204		
Dyno Pak		10 each		511204-10		

SCE Makes the Widest Range of Head Gaskets

From 8,000 horsepower fuel-burning Hemi's to Model "A" Fords, we've got it sealed.

PRO COPPER

Not all solid copper gaskets are created equal. SCE uses premium 99% pure copper sheets that are precisely rolled to our specifications (choice of 10 different thicknesses) and tested for uniform flatness to assure precise cylinder head-to-block alignment and eliminate uneven loading. After processing, each gasket is annealed to ensure optimum mating and provide measurable gains in cylinder sealing, as evidenced by lower leak-down percentages. O-ringing recommended.

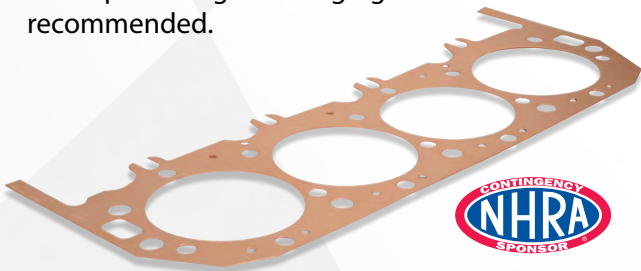

ICS TITAN

Patented Integral Combustion Seals perform the function of O-ringed blocks and heads without the added machining costs. They also provide extra sealing in high combustion pressure environments where rules prohibit O-ringing. The ICS Titan features stainless steel O-ring wire inserted into the gasket body around the cylinder bore, with combustion pressure forcing the flanges against the head and block for a secondary seal. Coolant and oil seals also included.

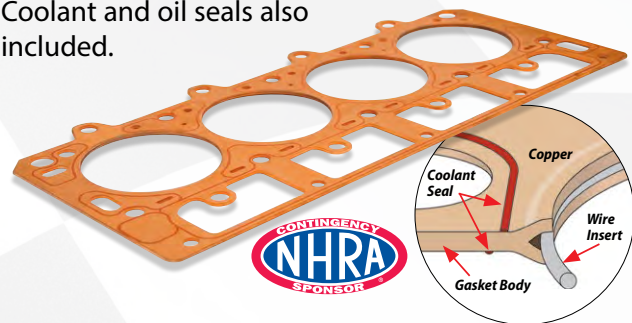

TITAN

SCE takes solid copper gaskets to the next level by adding patented coolant and oil seals to provide effective containment channels with a minimal clamping load. They are on both sides of the gasket and offset so that when compressed they lie in a single plane with the gasket body thereby "tripping" additional clamp load to the combustion seal, allowing for increased cylinder sealing. Titan gaskets are also available in 9 popular thicknesses.



PRO SEAL COMPOSITE

Here's an effective solution for excellent sealing in high performance street and mild competition applications. SCE's unique Pro Seal composite gaskets feature only three elements: a cold rolled steel core with pure graphite facing attached to both sides, plus an extra thick steel fire ring armor. It's a purely compressible gasket that can handle up to 15 lbs. of boost or a 150-shot of nitrous, but won't damage aluminum heads like competitive designs with O-rings.



Recommended Applications

for Various Head Gaskets

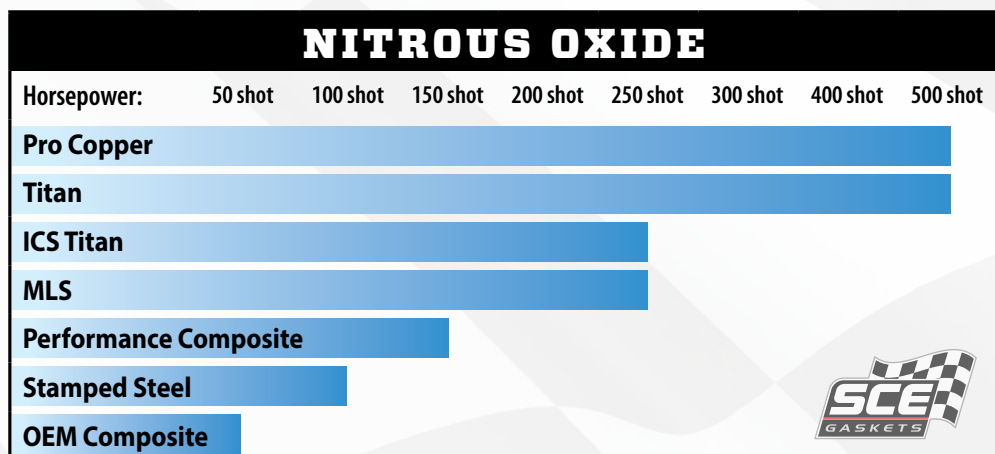
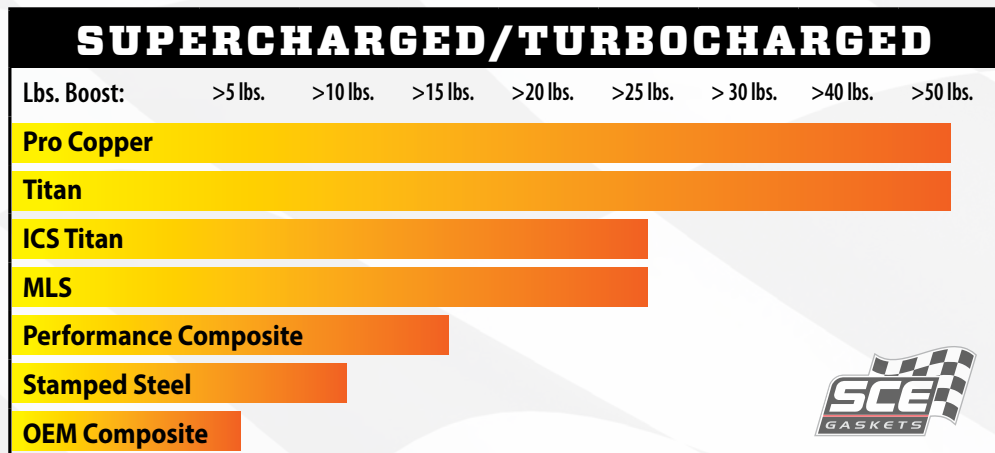
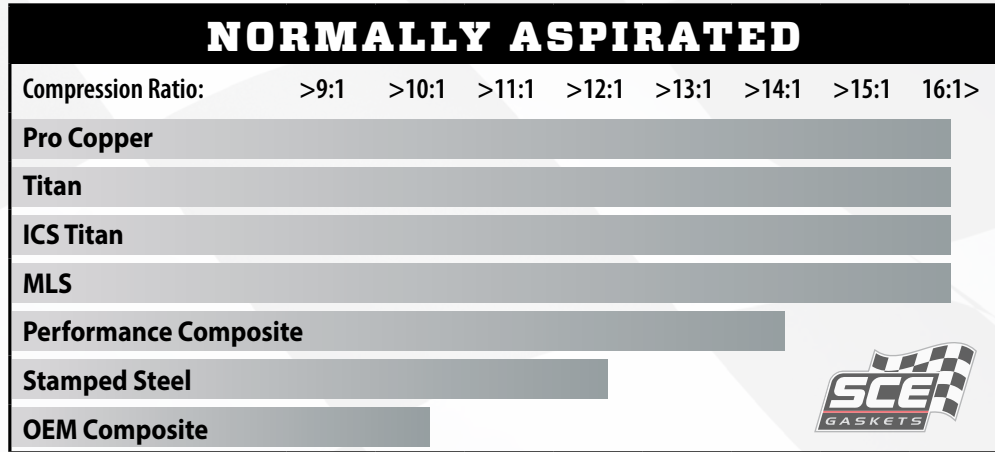

Note: These graphs will provide a baseline indication as to which type of head gaskets should be employed in various applications. Actual limits are the responsibility of the builder, given various factors that can influence gasket performance, such as camshaft design, ignition timing, fuel quality and mixture, etc.

SCE Dynopak BULK SETS



Bulk 10-Packs for Engine Builders

Another SCE first: Dyno Paks™ are tailor-made for engine builders and other volume gasket users. Each Dyno Pak contains 10 complete sets of the gaskets or seals you specify, clearly marked and shipped in a reusable box to protect your investment. Unlike other bulk programs which require a purchase of 100 sets or more, this bulk program is small enough to make sense yet still offers a significant 20% discount over the individual packaged price.

If you're an engine builder, make sure you stock your supply room with SCE Dyno Paks and reap the benefits of extra profits.

Dyno Pak part numbers are designated by a -10 suffix & listed adjacent to, below, or to the right of each individual part number.

FIND THEM HERE

Short Block Gaskets and Seals

Application	Qty	Oil Pan Gasket	Oil Pump Gasket	Front Cover Gaskets TC, WP, FP	Water Pump	Timing Cover Seal	Timing Cover Set	Rear Main Seal	Fuel Pump	Water Outlet
1966-72 304-401ci Accu Seal E	Each	Rubberized Fiber 129090	12901	12900	12904	12902	12905	12906	12908	
Dyno Pak	10 pak	11091-10		29075-10		2902-10	29075-10	2906-10	2908-10	

Valve Cover Gaskets

Application	Qty	Cork, Hi Density 3/16" Thick Street Performance	Cork, Hi Density 5/16" Thick Street Performance	Laminated Silicone Cork 1/4" Thick Racing/Hi Vacuum	Laminated Silicone Cork 1/4" Thick Racing/Hi Vacuum	Molded Silicone Rubber Street Performance	Steel Core Teflon coated .078" Thick Alcohol, Fuel
AMC V-8 1966-Up	1pr	Also fits Edelbrock Performer RPM AMC aluminum head and Indy 401-SR	129076	29075	229076	N/A	N/A
Dyno Pak	10pr		29076-10	29075-10	29076-10		

Intake Gaskets

Application	Accu Seal E Standard gasket material	E Dyno Pak Bulk pack of 10pr	Accu Seal Pro Premium material *Beaded Ports	Pro Dyno Pak Bulk Pack of 10pr
390-401 AMC 1.100" x 2.200 x .062" .125 thickness	Also fits Edelbrock Performer RPM AMC 129101 129106	29101-10 29106-10	229101*	229101-10

Racing & Performance ---

AMC V8	10
Arias, Fontana, MBR	11
Buick V6	12
Buick V8	13
Chevrolet 90° V6	14
Chevrolet Gen III-IV LS Small Block	16
Chevrolet 283-400ci Small Block	18
Chevrolet Big Block	24
Chrysler Small Block	34
Chrysler Big Block	37
Other Chrysler Engines	44
Ford Inline 4	45
Ford Small Block	46
Ford Big Block	51
GM Inline 4	56
Honda	57
Mitsubishi	58
Nissan	60
Oldsmobile	61
Pontiac	63
Subaru	65
Toyota	66
Volkswagen	67
Turbo & Collector Gaskets	68
Accessories	68
Fuel System Gaskets	69
Blower Gaskets	70
Driveline Gaskets	71

Service & Overhaul ---

Engine Master • Table of Contents	72
--	----

Tech Tips ---

Installation Instructions	354
---------------------------------	-----

Short Block Gaskets & Seals

Application	Qty	Oil Pan Gasket	Oil Pump Gasket	Front Cover Gaskets TC, WP, FP	Water Pump	Timing Cover Seal	Timing Cover Set	Rear Main Seal	Fuel Pump	Water Outlet
1966-78 304, 343, 360, 390 & 401ci V8		Rubberized Fiber								
	Each	129090	12901	12900	12904	12902	TCS 085-0 <i>supersedes</i> 12903	RS 085-5 <i>supersedes</i> 12905	12906	12908
	10 pak	29090-10		2900-10		2902-10		2905-10	2906-10	2908-10

Valve Cover Gaskets

Fitment	Qty	Cork, Hi Density 5/16" Thick <i>Street/Strip</i>	Laminated Silicone Cork 1/8" Thick <i>Racing/Hi Vacuum</i>	Laminated Silicone Cork 1/4" Thick <i>Racing/Hi Vacuum</i>	Molded Silicone Rubber <i>Street Performance</i>	Steel Core Teflon® Coated .078" Thick <i>Severe Duty</i>
AMC V8 all		<i>Also fits Edelbrock AMC Performer RPM aluminum head and Indy 401SR aluminum head</i>				
	1 pr	129076	229075	229076		
	10 pr	29076-10	229075-10	229076-10		

Intake Gaskets

Fitment & Dimensions	Thickness	Accu Seal E <i>Standard Material</i>	E Dyno Pak <i>Bulk Pak of 10 pr</i>	Accu Seal Pro <i>Premium Material</i>	Pro Dyno Pak <i>Bulk Pak of 10 pr</i>
AMC 360-401 V8		<i>Also fits Edelbrock Performer RPM and Indy 401-SR</i>			
1.100" x 2.200"	.062"	129101	29101-10	229101	229101-10
1.100" x 2.200"	.120"	129106	29106-10	<i>Bead Sealed Ports</i>	

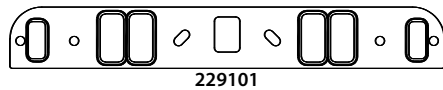

Exhaust Gaskets

Fitment & Dimensions	Accu Seal E <i>Standard Material</i>	E Dyno Pak <i>Bulk Pak of 10 pr</i>	Accu Seal Pro <i>Premium Material</i>	Pro Dyno Pak <i>Bulk Pak of 10 pr</i>	Pro Copper Embossed <i>Raised Sealing Bead</i>	Pro Copper Annealed <i>Flat, Soft .062" Thick</i>
1970-78 "Dog Leg" Port	<i>Also fits Edelbrock Performer RPM and Indy 401-SR</i>					
	129080	29080-10	229080	29180-10	4029	E29186 <i>supersedes</i> 029186
1966-69 Stock Rectangle Port	129081	29081-10	229081	29181-10		E29286 <i>supersedes</i> 029286

See fitment instructions on page 358

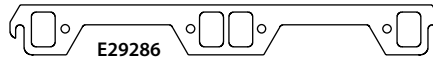
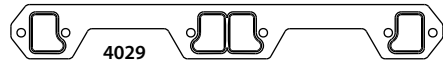

Head Gaskets

Performance Composite Head Gasket

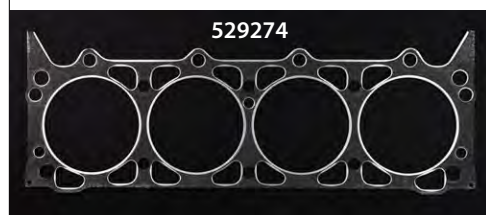

- Fits AMC 360-401 V-8: Original AMC design metal clad head gasket with large coolant passages for road course competition
- Bore Opening: 4.270"
- Compressed Thickness: .038"
- Packaged individually

Copper Racing Head Gaskets for AMC V8

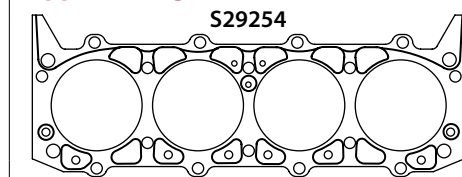

- Copper racing head gaskets include additional bolt holes at 6 o'clock position for aftermarket/modified heads

Gasket Style	Bore	Thickness								
		.021"	.032"	.043"	.050"	.062"	.072"	.080"	.093"	
Pro Copper for use with o-rings & sealant Titan sealed coolant passages, for use with o-rings	4.200" round	P29202	P29203	P29204	P29205	P29206	P29207	P29208	P29209	
ICS Titan sealed coolant passages, integral combustion o-ring		T29203	T29204	T29205	T29206	T29207	T29208	T29209		
Pro Copper for use with o-rings & sealant Titan sealed coolant passages, for use with o-rings	4.250" round	P29252	P29253	P29254	P29255	P29256	P29257	P29258	P29259	
ICS Titan sealed coolant passages, integral combustion o-ring		T29253	T29254	T29255	T29256	T29257	T29258	T29259		
		S29254	S29255	S29256	S29257	S29258	S29259	S29259	S29259	

"P" prefix supersedes "O" prefix • Packaged in pairs

Short Block Gaskets & Seals

Application	Qty	Oil Pan Gasket	Oil Pump Gasket	Front Cover Gasket	Water Pump	Timing Cover Seal	Timing Cover Set	Rear Main Seal	Fuel Pump	Water Outlet
Arias/Fontana/MBR Billet with 2.75" Chevrolet main journal Accu Seal E	Each	183090	N/A	18509	N/A	11302	N/A	11305	N/A	18501
	10 pak	83090-10	N/A	8509-10		1302-10		1305-10		8501-10
Accu Seal Pro	Each	Steel Core 283090	N/A		N/A	Viton® 21302		Viton® 21305	N/A	
	10 pak	283090-10				21302-10		21305-10		

Valve Cover Gaskets

Fitment	Qty	Cork, Hi Density 5/16" Thick <i>Street Performance</i>	Laminated Silicone Cork 1/8" Thick <i>Competition/Hi Vacuum</i>	Laminated Silicone Cork 1/4" Thick <i>Competition/Hi Vacuum</i>	Molded Silicone Rubber <i>Street/Strip</i>	Fuel Resistant Fiber .062" Thick <i>Sportsman Racing</i>	Nitro/Methanol Steel Core Teflon® Coated .078" Thick <i>Severe Duty</i>
Early Arias 11.250" wide	1 pr					183075	283075
	10 pr					183075-10	83175-10
Fontana & MBR 8.3L Billet	1 pr					184075	284075
	10 pr					84075-10	84175-10

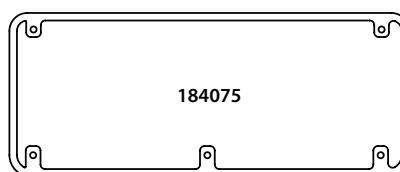
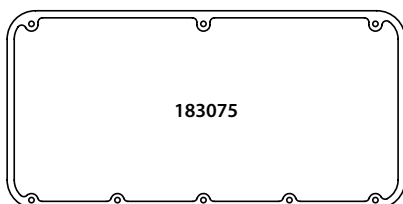
Intake Gaskets

Fitment & Dimensions	Thickness	Accu Seal E <i>Standard Material</i>	E Dyno Pak <i>Bulk Pak of 10 pr</i>	Accu Seal Pro <i>Premium Material</i>	Pro Dyno Pak <i>Bulk Pak of 10 pr</i>
Arias 8.3L Cast Head 2.0" x 2.312"	.062"	183101	83101-10	283101	283101-10
Fontana/MBR Billet 2.0" x 2.312"	.062"	183102	83102-10	283102	283102-10

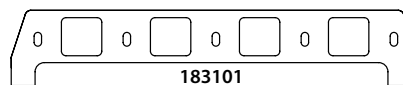
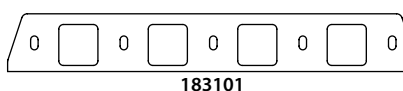
Exhaust Gaskets

Fitment & Dimensions	Accu Seal E <i>Standard Non-Asbestos</i>	E Dyno Pak <i>Bulk Pak of 10 pr</i>	Accu Seal Pro <i>Premium material</i>	Pro Dyno Pak <i>Bulk Pak of 10 pr</i>	Pro Copper Embossed <i>Raised Sealing Bead</i>	Pro Copper Annealed <i>Flat, Soft .062" Thick</i>
Arias, Fontana, MBR 2.550" x 1.820"	183081	83081-10	283081	283081-10	4083	E83186 <i>supersedes 083186</i>

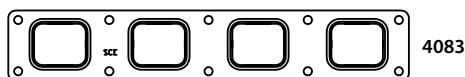

See fitment instructions on page 358

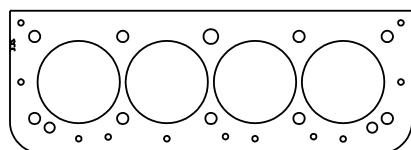
Head Gaskets
Copper Racing Head Gaskets for Arias, Fontana & MBR

P10524

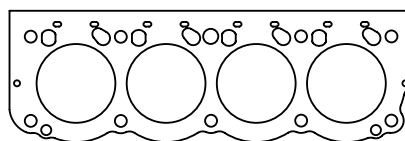

P83524

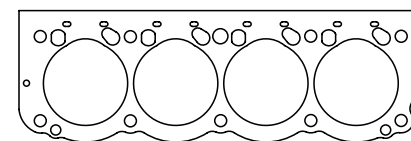

P84524

Application	Gasket Style	Bore	Thickness							
			.043"	.050"	.062"	.072"	.080"	.093"	.100"	.110"
Arias 10L	Pro Copper for use with o-rings and sealant for water passages	4.440"	P10444	P10445	P10446	P10447	P10448	P10449	P10440	P10441
		4.520"	P10524	P10525	P10526	P10527	P10528	P10529	P10520	P10521
Arias 8.3L round bore	Pro Copper for use with o-rings and sealant for water passages	4.380"	P83384	P83385	P83386	P83387	P83388	P83389	P83380	P83381
		4.440"	P83444	P83445	P83446	P83447	P83448	P83449	P83440	P83441
		4.470"	P83474	P83475	P83476	P83477	P83478	P83479	P83470	P83471
		4.520"	P83524	P83525	P83526	P83527	P83528	P83529	P83520	P83521
Fontana/MBR 8.3L Billet with pocket for 2.640" intake valve	Pro Copper for use with o-rings and sealant for water passages	4.380"	P84384	P84385	P84386	P84387	P84388	P84389	P84380	P84381
		4.440"	P84444	P84445	P84446	P84447	P84448	P84449	P84440	P84441
		4.470"	P84474	P84475	P84476	P84477	P84478	P84479	P84470	P84471
		4.520"	P84524	P84525	P84526	P84527	P84528	P84529	P84520	P84521

Packaged in Pairs • "P" prefix supersedes "0" prefix

Short Block Gaskets & Seals

Application	Qty	Oil Pan Gasket	Oil Pump Gasket	Front Cover Gaskets TC, WP, FP	Water Pump	Timing Cover Seal	Timing Cover Set	Rear Main Seal	Fuel Pump	Water Outlet
1975-85 <i>also fits</i> Stage 1 & 2 231 V6	Each	14 Bolt Pan 172091	17203	17200	17204	17202	TCS 109-6	RS 109-6	17206	17208
	10 pak	72091-10		7200-10		7202-10		7205-10	7206-10	7208-10
1984-88 231 V6	Each	20 Bolt Pan 172090	17203	17200	17204	17202	TCS 109-6	RS 109-6	17206	17208
	10 pak	72090-10		7200-10		7202-10		7205-10	7206-10	7208-10

Valve Cover Gaskets

Application	Qty	Cork, Hi Density 5/16" Thick <i>Street/Strip</i>	Laminated Silicone Cork 1/8" Thick <i>Racing/Hi Vacuum</i>	Laminated Silicone Cork 1/4" Thick <i>Racing/Hi Vacuum</i>	Molded Silicone Rubber <i>Street Performance</i>	Steel Core Teflon® Coated .078" Thick <i>Severe Duty</i>
1978-89 231 V6 2 over 2 bolt	1 pr 10 pr		272175 72175-10	272176 72176-10	N/A	272177

Intake Gaskets

Fitment & Dimensions	Thickness	Accu Seal E <i>Standard Material</i>	E Dyno Pak <i>Bulk Pak of 10 pr</i>	Accu Seal Pro <i>Premium Material</i>	Pro Dyno Pak <i>Bulk Pak of 10 pr</i>
Stage 1 Stock Port .900" x 1.975"	.062"	172101	72101-10	272101	72101-10
Stage 1 Large Port 1.250" x 2.00"	.062"	172102	72102-10	272102	72102-10
Stage 2 1.250" x 2.00"	.062"	172103	72103-10	272103	72103-10
Stock Plenum Gasket	.062"	172104	72104-10	272104	72104-10
Champion Plenum Gasket	.062"	172105	72105-10	272105 <i>Bead Sealed Perimeter</i>	72105-10
Idle Air Control Valve Gasket	.062"	172106	72106-10		

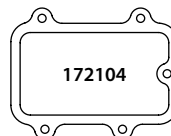
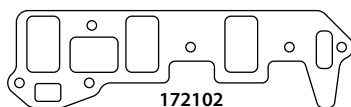
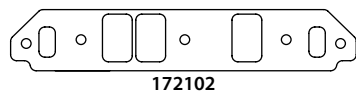

Exhaust Gaskets

Application	Accu Seal E <i>Standard Material</i>	E Dyno Pak <i>Bulk Pak of 10 pr</i>	Accu Seal Pro <i>Premium Material</i>	Pro Dyno Pak <i>Bulk Pak of 10 pr</i>	Pro Copper Embossed <i>Raised Sealing Bead</i>	Pro Copper Annealed <i>Flat, Soft .062" Thick</i>
Stage 1 Stock Port 1.075" x 1.500"	172080	72080-10	272180	72180-10	4472	E72186 <i>supersedes 072186</i>
Champion Aluminum Head 1.075" x 1.500"					4072	
Stage 2 Adapter Gasket 1.750' Round					4372	
Stage 2 Rectangle Port 1.500' x 1.750"	172081	72081-10	272181	72181-10	4572	
Turbo Flange Gasket 3 Bolt 2.275" Round	172082	72082-10	272182	72182-10	4172	
Turbo Inlet & Wastegate 4 Bolt 2 Port					4672	

See fitment instructions on page 358

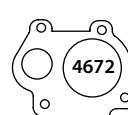
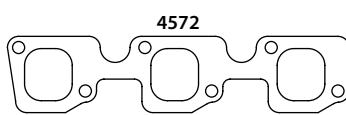
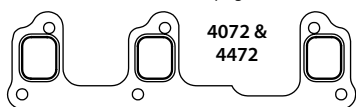

Head Gaskets

Performance Composite Head Gasket

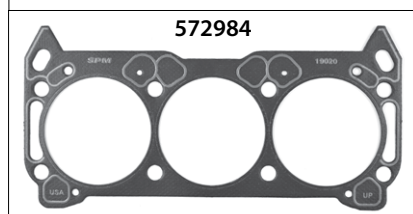

- Fits Buick 231 V6 Stage 1 Block & Cylinder Heads.
- Bore opening: 3.980" round.
- Compressed thickness: .041"
- Packaged individually

Copper Racing Head Gaskets for Buick V6

• Copper racing head gaskets include bolt & cooling allowance for Stage 2 block & heads

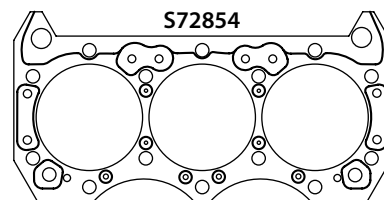

Gasket Style	Bore	Thickness								
		.021"	.032"	.043"	.050"	.062"	.072"	.080"	.093"	
Pro Copper for use with o-rings & sealant	3.850" round	P72852	P72853	P72854	P72855	P72856	P72857	P72858	P72859	
Titan sealed coolant passages, for use with o-rings			T72853	T72854	T72855	T72856	T72857	T72858	T72859	
ICS Titan sealed coolant passages, integral combustion o-ring		<i>No Fit: stock combustion chamber extends beyond 3.850" dia.</i>								
Pro Copper for use with o-rings & sealant	3.950" round	P72952	P72953	P72954	P72955	P72956	P72957	P72958	P72959	
Titan sealed coolant passages, for use with o-rings			T72953	T72954	T72955	T72956	T72957	T72958	T72959	
ICS Titan sealed coolant passages, integral combustion o-ring			S72954	S72955	S72956	S72957	S72958	S72959		
Pro Copper for use with o-rings & sealant	4.010" round	P72002	P72003	P72004	P72005	P72006	P72007	P72008	P72009	
Titan sealed coolant passages, for use with o-rings			T72003	T72004	T72005	T72006	T72007	T72008	T72009	
ICS Titan sealed coolant passages, integral combustion o-ring			S72004	S72005	S72006	S72007	S72008	S72009		

"P" prefix supersedes "0" prefix • Packaged in Pairs.

Short Block Gaskets & Seals

Application	Qty	Oil Pan Gasket	Oil Pump Gasket	Front Cover Gaskets TC, WP, FP	Water Pump	Timing Cover Seal	Timing Cover Set	Rear Main Seal	Fuel Pump	Water Outlet
1967-76 400, 430, 455ci Buick V8	Each 10 pak	<i>Rubberized Fiber</i>								
		171090	17103	17100	17104	17102	TCS 107-5	RS 109-5	17106	17108
		71090-10		7100-10		7102-10		7105-10	7106-10	7108-10

Valve Cover Gaskets

Fitment	Qty	Cork, Hi Density 5/16" Thick <i>Street/Strip</i>	Laminated Silicone Cork 1/8" Thick <i>Racing/Hi Vacuum</i>	Laminated Silicone Cork 1/4" Thick <i>Racing/Hi Vacuum</i>	Molded Silicone Rubber <i>Street Performance</i>	Steel Core Teflon® Coated .078" Thick <i>Severe Duty</i>
1967-76 Buick V8 all		<i>Also fits Edelbrock Performer RPM Buick and T/A Performance Eliminator heads</i>				
	1pr 10pr		271175	271176	N/A	N/A
			71175-10	71176-10		

Intake Gaskets

Fitment & Dimensions	Thickness	Accu Seal E <i>Standard Material</i>	E Dyno Pak <i>Bulk Pak of 10 pr</i>	Accu Seal Pro <i>Premium Material</i>	Pro Dyno Pak <i>Bulk Pak of 10 pr</i>
<i>Also fits Edelbrock Performer RPM Buick and T/A Performance Stage 1 SE</i>					
Stage 1 1.100" x 2.375"	.062"	171101	71101-10	271101 <i>Bead sealed ports</i>	271101-10 <i>Bead sealed ports</i>
<i>Also fits T/A Performance Stage 1 TE</i>					
Stage 1 Large Port 1.220" x 2.520"	.062"	171104	71104-10	271104	271104-10
Stage 3 1.310" x 2.400"	.062"	171102	71102-10	271102	271102-10
Stage 4 1.600" x 2.550"	.062"	171103	71103-10	271103	271103-10



271101

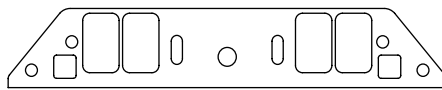

171103

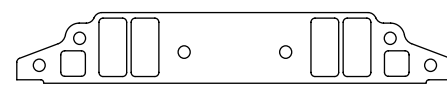

171104

Exhaust Gaskets

Fitment	Accu Seal E Standard Material	E Dyno Pak Bulk Pak of 10 pr	Accu Seal Pro Premium Material	Pro Dyno Pak Bulk Pak of 10 pr	Pro Copper Embossed Raised Sealing Bead	Pro Copper Annealed Flat, Soft .062" Thick
<i>Also fits Edelbrock Performer RPM Buick and T/A Performance Stage 1 SE & Stage 1 TE heads</i>						
Stage 1 Rectangle	171080	71080-10	271180	71180-10	4071	E71186 <i>supersedes 071186</i>
Stage 2 Round Port	171081	71081-10	271181	71181-10	4171	E71286 <i>supersedes 071286</i>

See fitment instructions on page 358

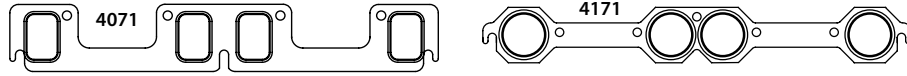

Head Gaskets

Performance Composite Head Gasket



- Fits Buick 400, 430 & 455 V8.
- Bore opening: 4.390" round.
- Compressed thickness: .041"
- Includes extra bolt holes at 6 o'clock position.
- Packaged individually.

Copper Racing Head Gaskets for Buick V8

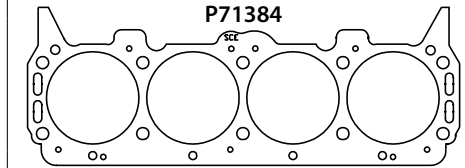

- Copper racing head gaskets include extra bolt holes at 6 o'clock position

Gasket Style	Bore	Thickness								
		.021"	.032"	.043"	.050"	.062"	.072"	.080"	.093"	
Pro Copper for use with o-rings & sealant ICS Titan integral combustion o-ring	4.160" round	P71152	P71153	P71154 S71154	P71155 S71155	P71156 S71156	P71157 S71157	P71158 S71158	P71159 S71159	
Pro Copper for use with o-rings & sealant ICS Titan integral combustion o-ring	4.250" round	P71252	P71253	P71254 S71254	P71255 S71255	P71256 S71256	P71257 S71257	P71258 S71258	P71259 S71259	
Pro Copper for use with o-rings & sealant ICS Titan integral combustion o-ring	4.380" round	P71382	P71383	P71384 S71384	P71385 S71385	P71386 S71386	P71387 S71387	P71388 S71388	P71389 S71389	

Packaged in Pairs. • "P" prefix supersedes "O" prefix

CHEVROLET 90° V6

Short Block Gaskets & Seals

Application	Qty	Oil Pan Gasket	Oil Pump Gasket	Front Cover Gaskets TC, WP, FP	Water Pump	Timing Cover Seal	Timing Cover Set	Rear Main Seal	Fuel Pump	Water Outlet
1985 262ci 90° V6	Each	117090		11100	11101	11102	11103	11105	11106	11108
	10 pak	17090-10		1100-10	1101-10	1102-10		1105-10	1106-10	1108-10
1986-92 262ci (4.3L)	Each	1 pc molded 217091		11100	11101	11102	TCS 303-5	1 pc radial 21155	11706	21108
	10 pak	17091-10		1100-10	1101-10	1102-10				



Valve Cover Gaskets

Fitment	Qty	Cork, Hi Density 5/16" Thick Street/Strip	Laminated Silicone Cork 1/8" Thick Racing/Hi Vacuum	Laminated Silicone Cork 1/4" Thick Racing/Hi Vacuum	Molded Silicone Rubber Street Performance	Steel Core Teflon® Coated .078" Thick Severe Duty
4 perimeter bolts 2 over 2, aligned						
1978-86 90° V-6	1pr		217071	217072		
	10pr		217071-10	217072-10		
Center Bolts						
1987-93 4.3L V-6	1pr		217073	217074		
	10pr		217073-10	217074-10		
4 perimeter bolts 2 over 2 offset, fits NASCAR® Busch Series competition heads from 1995 & prior						
18° High Port	1pr		217075	217076		
	10pr		217075-10	217076-10		

Intake Gaskets

Fitment & Dimensions	Thickness	Accu Seal E Standard Material	E Dyno Pak Bulk Pak of 10 pr	Accu Seal Pro Premium Material	Pro Dyno Pak Bulk Pak of 10 pr
Stock Port					
1.100" x 2.200" x .062"	.062"	117101	17101-10	217101	217101-10
Fits NASCAR® Busch Series competition heads from 1995 & prior					
18° High Port 1.275" x 2.175"	.062"	117102	17102-10	217102	217102-10
	.090"	117103	17103-10		
	.120"	117104	17104-10		

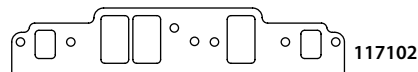
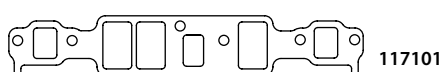
Exhaust Gaskets

Fitment & Dimensions	Accu Seal E Standard Material	E Dyno Pak Bulk Pak of 10 pr	Accu Seal Pro Premium Material	Pro Dyno Pak Bulk Pak of 10 pr	Pro Copper Embossed Raised Sealing Bead	Pro Copper Annealed Flat, Soft .062" Thick
Stock Port						
1.5" i.d. Round	117080	17080-10	217080	217080-10	4017	E17086 supersedes 017086
Fits Turbo heads/manifolds found in GM SyTy (Syclone & Typhoon) 1991 & later						
Large Square Port						
1.400" x 1.400"	117081	17081-10	217081	217081-10	4117	E17087 supersedes 017087
Fits all 18° heads including High Port						
18° Degree						
1.625" i.d. Round	117082	17082-10	217082	217082-10	4217	

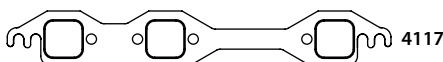
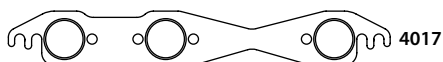

See fitment instructions on page 358

Head Gaskets
Performance Composite Head Gasket

- Fits Chevrolet 90° V6 1985 & later with 4.00" stock bore.
- Gasket bore opening: 4.120"
- Compressed thickness: .050"
- Packaged individually.

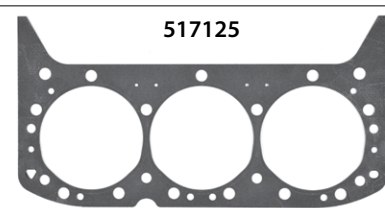
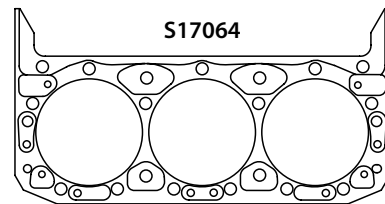
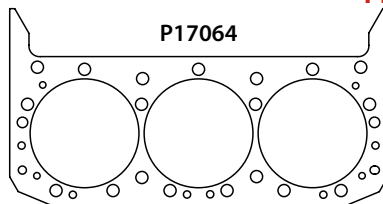

Copper Racing Head Gaskets for Chevrolet 90° V6

Gasket Style	Bore	Thickness								
		.021"	.032"	.043"	.050"	.062"	.072"	.080"	.093"	
Pro Copper for use with o-rings & sealant Titan sealed coolant passages, for use with o-rings ICS Titan sealed coolant passages, integral combustion o-ring	4.060" round	P17062	P17063 T17063	P17064 T17064 S17064	P17065 T17065 S17065	P17066 T17066 S17066	P17067 T17067 S17067	P17068 T17068 S17068	P17069 T17069 S17069	
		P17152	P17153 T17153	P17154 T17154 S17154	P17155 T17155 S17155	P17156 T17156 S17156	P17157 T17157 S17157	P17158 T17158 S17158	P17159 T17159 S17159	
Pro Copper for use with o-rings & sealant Titan sealed coolant passages, for use with o-rings ICS Titan sealed coolant passages, integral combustion o-ring	4.160" round	P17202	P17203 T17203	P17204 T17204 S17204	P17205 T17205 S17205	P17206 T17206 S17206	P17207 T17207 S17207	P17208 T17208 S17208	P17209 T17209 S17209	
		P17202	P17203 T17203	P17204 T17204 S17204	P17205 T17205 S17205	P17206 T17206 S17206	P17207 T17207 S17207	P17208 T17208 S17208	P17209 T17209 S17209	

"P" prefix supersedes "O" prefix • Copper Head Gaskets are packaged in Pairs.

Short Block Gaskets & Seals

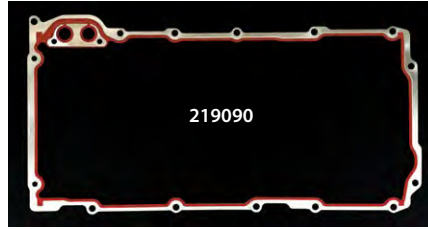
Application	Qty	Oil Pan Gasket	Front Cover Gasket	Water Pump	Timing Cover Seal	Rear Cover Gasket	Rear Main Seal	Thermostat O-ring
97-2008 LS series except LS6 Batwing & LS7 dry sump	Each	219090	11900	11901	11902	11907	21905	11908
<i>97-2008 LS Series (except Corvette) Bottom End Gasket Set: 219327</i>								



Valve Cover Gaskets

Fitment	Qty	Cork, Hi Density 5/16" Thick <i>Street/Strip</i>	Laminated Silicone Cork 1/8" Thick <i>Racing/Hi Vacuum</i>	Laminated Silicone Cork 1/4" Thick <i>Racing/Hi Vacuum</i>	Molded Silicone Rubber <i>Street Performance</i>	Steel Core Teflon® Coated .078" Thick <i>Severe Duty</i>
1997-98 LS with Perimeter Bolt Valve Covers	1pr	N/A	N/A	N/A	VS 320-2	N/A
1999 & later LS with Center Bolt Valve Covers	1pr	N/A	N/A	N/A	VS 320-4	N/A

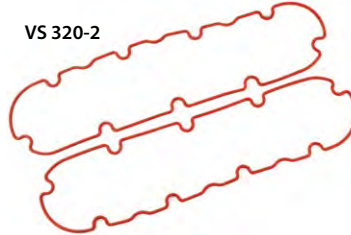

Intake Gaskets

Fitment & Dimensions	Thickness	Accu Seal E <i>Standard Material</i>	E Dyno Pak <i>Bulk Pak of 10 pr</i>	Accu Seal Pro <i>Premium Material</i>	Pro Dyno Pak <i>Bulk Pak of 10 pr</i>
LS1 / LS2 / LS6 4 Barrel 1.150" x 3.375"	.032"	<i>Fits 4 Barrel Aftermarket Manifolds with Rectangular Ports</i>			
		119133	19133-10		
LS1 / LS2 / LS6 4 Barrel 1.150" x 3.375"	.062"	<i>Silicone Bead Seal at Ports</i>			
		119134	19134-10	219134 <i>supersedes 211134</i>	219134-10 <i>supersedes 211134-10</i>
LS1 / LS2 / LS6 4 Barrel 1.150" x 3.375"	.125"	119135	19135-10		
LS7 / CSR / World LS7X	.032"	<i>Fits 4 Barrel Aftermarket Manifolds with Rectangular Ports</i>			
		119101	19101-10		
LS7 / CSR / World LS7X	.062"	119102	19102-10	219102	219102-10
		119106	19106-10		
LS7 / CSR / World LS7X	.125"				
LSX 454 CT	.062"	119107	19107-10	219107	219107-10
LSX 454 DR	.062"	119108	19108-10	219108	219108-10
L92	.032"	119104	19104-10		
L92	.062"	119103	19103-10	219103	219103-10
L92	.125"	119105	19105-10		

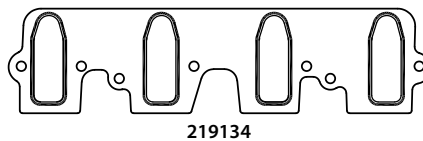
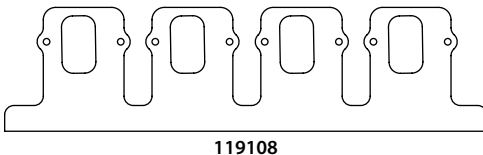
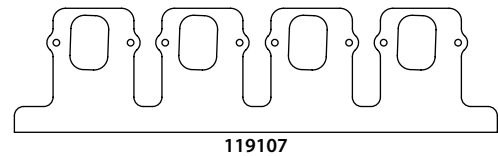
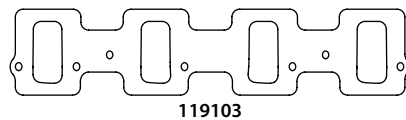
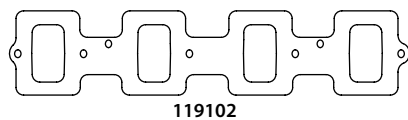

Exhaust Gaskets

Fitment & Dimensions	Accu Seal E <i>Standard Material</i>	E Dyno Pak <i>Bulk Pak of 10 pr</i>	Accu Seal Pro <i>Premium Material</i>	Pro Dyno Pak <i>Bulk Pak of 10 pr</i>	Pro Copper Embossed <i>Raised Sealing Bead</i>	Pro Copper Annealed <i>Flat, Soft .062" Thick</i>
LS1 / LS2 / LS6 1.625" stock port opening	119080	19080-10	219180	19180-10	4019	
<i>Standard LS bolt pattern fits up to 13/4" headers</i>						
LS1 / LS6 / LS7 / LQ9 1.750" large port	119081	19081-10	219181	19181-10	4119	
<i>Standard LS bolt pattern fits up to 17/8" headers</i>						
LS7 / LQ9 / World LS7X 2.130" race port					4219	
<i>Standard LS bolt pattern fits up to 21/4" race headers</i>						
Arias LS Hemi					4319	
<i>Unique bolt pattern fits only Arias LS Hemi, seals 2" header opening</i>						
LSX 454 DR					4419	
All-Pro LSW 12-2					4519	

See fitment instructions on page 358

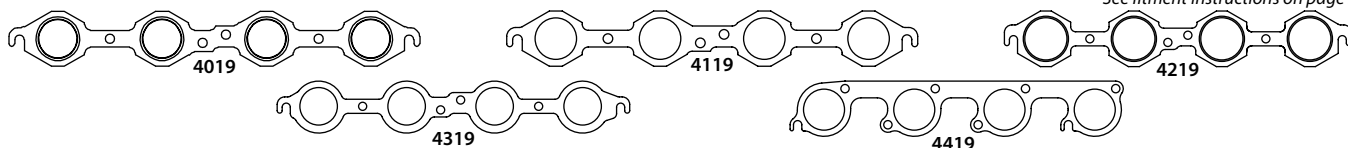

Head Gaskets

Performance Composite Head Gasket

- Fits Gen III & IV Chevrolet Small Block performance engines.
- Note: 97' - 01' Gen III must use composite head gasket p/n 519974.
- MLS gaskets will not seal coolant passages on early LS1 head casting numbers 5339, 8806, 9862.

519974



Copper Racing Head Gaskets for Gen III-IV Small Block

P19064

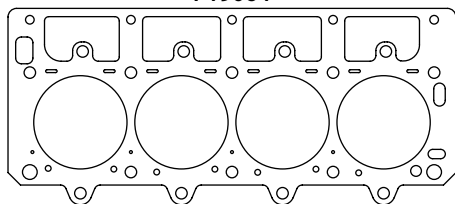

- Fits: LSX, LS7X, LS Next, Motown II, Warhawk
- All LS series Copper racing head gaskets use LSX 454 18 bolt pattern
- ICS Titan (S prefix) not recommended for 10 bolt engines

S19064

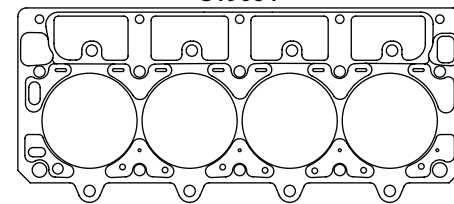

Gasket Style	Bore	Thickness								
		.021"	.032"	.043"	.050"	.062"	.072"	.080"	.093"	
Pro Copper for use with o-rings & sealant	3.950" round	P19952	P19953	P19954	P19955	P19956	P19957	P19958	P19959	
Titan sealed coolant passages, for use with o-rings			T19953	T19954	T19955	T19956	T19957	T19958	T19959	
ICS Titan sealed coolant passages, integral combustion o-ring				S19954	S19955	S19956	S19957	S19958	S19959	
Pro Copper for use with o-rings & sealant	4.010" round	P19012	P19013	P19014	P19015	P19016	P19017	P19018	P19019	
Titan sealed coolant passages, for use with o-rings			T19013	T19014	T19015	T19016	T19017	T19018	T19019	
ICS Titan sealed coolant passages, integral combustion o-ring				S19014	S19015	S19016	S19017	S19018	S19019	
Pro Copper for use with o-rings & sealant	4.060" round	P19062	P19063	P19064	P19065	P19066	P19067	P19068	P19069	
Titan sealed coolant passages, for use with o-rings			T19063	T19064	T19065	T19066	T19067	T19068	T19069	
ICS Titan sealed coolant passages, integral combustion o-ring				S19064	S19065	S19066	S19067	S19068	S19069	
Pro Copper for use with o-rings & sealant	4.160" round	P19162	P19163	P19164	P19165	P19166	P19167	P19168	P19169	
Titan sealed coolant passages, for use with o-rings			T19163	T19164	T19165	T19166	T19167	T19168	T19169	
ICS Titan sealed coolant passages, integral combustion o-ring				S19164	S19165	S19166	S19167	S19168	S19169	
Pro Copper for use with o-rings & sealant	4.200" round	P19202	P19203	P19204	P19205	P19206	P19207	P19208	P19209	
Titan sealed coolant passages, for use with o-rings			T19203	T19204	T19205	T19206	T19207	T19208	T19209	
ICS Titan sealed coolant passages, integral combustion o-ring				S19204	S19205	S19206	S19207	S19208	S19209	

"19" engine designator supersedes "LS" suffix • Packaged in Pairs.



Short Block Gaskets & Seals

Application	Qty	Oil Pan Gasket	Front Cover Gaskets TC, WP, FP	Water Pump	Timing Cover Seal	Timing Cover Set	Rear Main Seal	Fuel Pump	Water Outlet
1955-74 265-400ci SBC with left dipstick and .250" (thin) front pan seal.	<i>Accu-Seal E standard gasket materials, nitrile or silicone seals.</i>								
	Each	111091	11100	11101	11102	11103	11105	11107	11108
	Dyno pak	11091-10	1100-10	1101-10	1102-10		1105-10	1107-10	1108-10
	<i>Accu-Seal Pro premium gasket materials, Fluoroelastomer (Viton®) seals, molded water outlet.</i>								
Each		11109 Fits Full Circle Quick Change Front Cover		21102	21103	21105		21108	
Dyno pak		1109-10		21102-10		21105-10		21108-10	
1975-79 305-400ci SBC with left dipstick, 2 pc rr main and .400" (thick) front pan seal	<i>Accu-Seal E standard gasket materials, nitrile or silicone seals.</i>								
	Each	111090	11100	11101	11102	11103	11105	11107	11108
	Dyno Pak	11090-10	1100-10	1101-10	1102-10		1105-10	1107-10	1108-10
	<i>Accu-Seal Pro premium gasket materials, Fluoroelastomer (Viton®) seals, molded water outlet.</i>								
Each	211090 1 pc Molded Silicone Rubber with 'Backbone'	11109 Fits Full Circle Quick Change Front Cover		21102	21103	21105		21108	
Dyno Pak	211090-10	1109-10		21102-10		21105-10		21108-10	
1980-85 305-400ci SBC with right dipstick, 2 pc rr main and .400" (thick) front pan seal	<i>Accu-Seal E standard gasket materials, nitrile or silicone seals.</i>								
	Each	111092	11100	11101	11102	11103	11105	11107	11108
	Dyno pak	11092-10	1100-10	1101-10	1102-10		1105-10	1107-10	1108-10
	<i>Accu-Seal Pro premium gasket materials, Fluoroelastomer (Viton®) seals, molded water outlet.</i>								
Each	211090 1 pc Molded Silicone Rubber with 'Backbone'	11109 Fits Full Circle Quick Change Front Cover		21102	21103	21105		21108	
Dyno pak	211090-10	1109-10		21102-10		21105-10		21108-10	
1986 & later 305-350ci SBC with 1 pc rr main, right dipstick & .400" (thick) front pan seal	<i>Accu-Seal E standard gasket materials, nitrile or silicone seals.</i>								
	Each	111092	11100	11101	11102	11103			11108
	Dyno pak	11092-10	1100-10	1101-10	1102-10				1108-10
	<i>Accu-Seal Pro premium gasket materials, Fluoroelastomer (Viton®) seals, molded water outlet.</i>								
Each	211092 1 pc Molded Silicone Rubber with 'Backbone'	11109 Fits Full Circle Quick Change Front Cover		21102	21103	21155		21108	
Dyno pak	211092-10	1109-10		21102-10		21155-10		21108-10	
GM Targetmaster Crate Engine with 2 piece rear main seal, right & left dipstick	<i>Accu-Seal E standard gasket materials, nitrile or silicone seals.</i>								
	Each	111095	11100	11101	11102	11103	11105	11107	11108
	Dyno pak	11095-10	1100-10	1101-10	1102-10		1105-10	1107-10	1108-10
	<i>Accu-Seal Pro premium gasket materials, Fluoroelastomer (Viton®) seals, molded water outlet.</i>								
Each	211090 1 pc Molded Silicone Rubber with 'Backbone'	11109 Fits Full Circle Quick Change Front Cover		21102	21103	21105		21108	
Dyno pak	211090-10	1109-10		21102-10		21105-10		21108-10	
CNC Bowtie / Donovan 350 with straight rails no dipstick (trimmed for rod clearance)	<i>Accu-Seal E standard gasket materials, nitrile or silicone seals.</i>								
	Each	111094	11100	11101	11102	11103	11105	11107	11108
	Dyno pak	11094-10	1100-10	1101-10	1102-10		1105-10	1107-10	1108-10
	<i>Accu-Seal Pro premium gasket materials, Fluoroelastomer (Viton®) seals, molded water outlet.</i>								
Each	211097 Steel Core	11109 Fits Full Circle Quick Change Front Cover		21102	21103	21105		21108	
Dyno pak	211097-10	1109-10		21102-10		21105-10		21108-10	
GM-Chevrolet Performance Rocket Block Straight pan rails no dipstick (Also Fits CN Blocks Splay Cap SBC)	<i>Accu-Seal E standard gasket materials, nitrile or silicone seals.</i>								
	Each	111093	11100	11101	11102	11103	11105	11107	11108
	Dyno pak	11093-10	1100-10	1101-10	1102-10		1105-10	1107-10	1108-10
	<i>Accu-Seal Pro premium gasket materials, Fluoroelastomer (Viton®) seals, molded water outlet.</i>								
Each	211098 Steel Core	11109 Fits Full Circle Quick Change Front Cover		21102	21103	21105		21108	
Dyno pak	211098-10	1109-10		21102-10		21105-10		21108-10	
Donovan 410 High Cam Straight pan rails (trimmed for rod clearance)	<i>Accu-Seal E standard gasket materials, nitrile or silicone seals.</i>								
	Each	111096	11100HC		11102		11105		
	Dyno pak		1100HC-10		1102-10		1105-10		
	<i>Accu-Seal Pro premium gasket materials, Fluoroelastomer (Viton®) seals, molded water outlet.</i>								
Each	211099 Steel Core	11109 Fits Full Circle Quick Change Front Cover		21102		21105			
Dyno pak		1109-10		21102-10		21105-10			

Continued on page 19 ►

Short Block Gaskets & Seals continued

CN Blocks Cross Bolt wide rail SBC with one piece pan gasket	Each	111097					11105	
	Dyno pak	11097-10					1105-10	
	Accu-Seal Pro premium gasket materials, Fluoroelastomer (Viton®) seals, molded water outlet.							
	Each	211197 Steel Core					21105	
	Dyno pak	211197-10				21105-10		

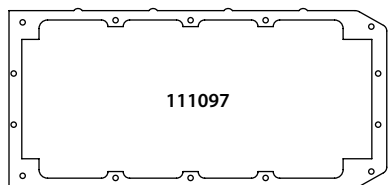
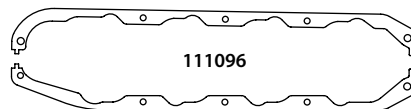
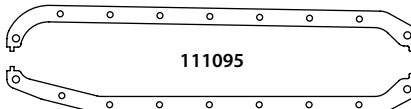
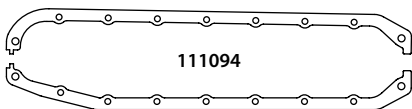
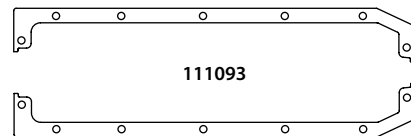
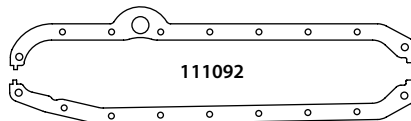
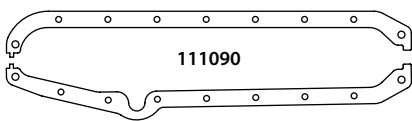

Valve Cover Gaskets

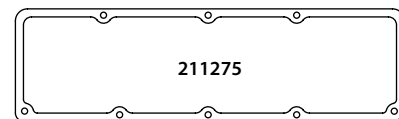
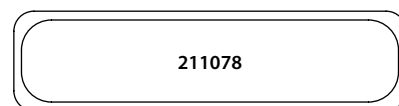
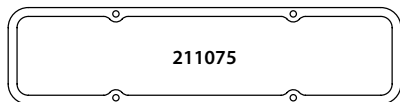
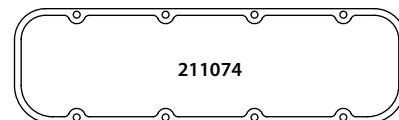
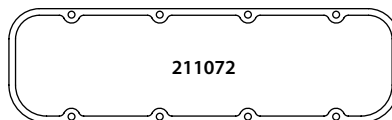
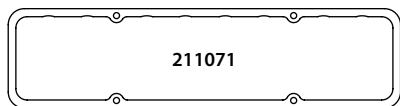
Fitment	Qty	Cork, Hi Density 5/16" Thick <i>Street/Strip</i>	Laminated Silicone Cork 1/8" Thick <i>Racing/Hi Vacuum</i>	Laminated Silicone Cork 1/4" Thick <i>Racing/Hi Vacuum</i>	Molded Silicone Rubber <i>Street Performance</i>	Steel Core Teflon® Coated .078" Thick <i>Severe Duty</i>
1957-85 283-400ci SBC	1pr	111076	211075	211076	211077	211173
	Dyno Pak	11076-10	211075-10	211076-10	211077-10	
1986-1997 SBC	1pr		211078	211079		211278
	Dyno Pak		211078-10	211079-10		
12° & 18° SBC heads	1pr		211071	211073		211178
	Dyno Pak		211071-10	211073-10		211178-10
Dart-Buick SBC	1pr		211275	211276		
	Dyno Pak		211275-10	211276-10		
GM-Chevrolet Performance SB2.2 "Mirror Port"	1pr		211072	211172		211273
	Dyno Pak		211072-10	211172-10		211273-10
GM-Chevrolet Performance Splayed Valve	1pr		211074	211174		211274
	Dyno Pak		211074-10	211174-10		211274-10

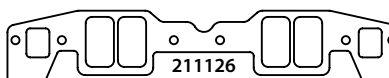
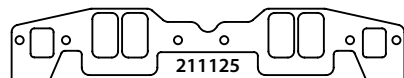
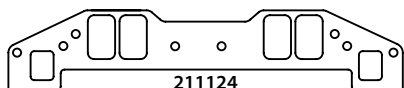
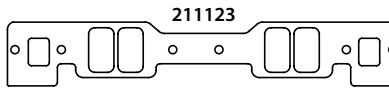
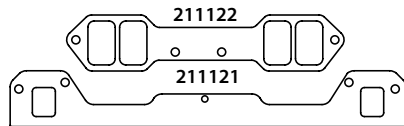
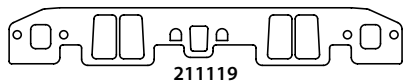
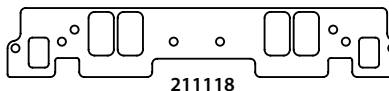
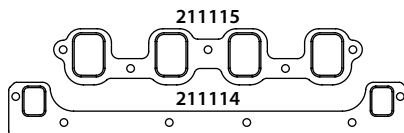
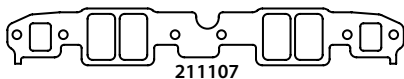
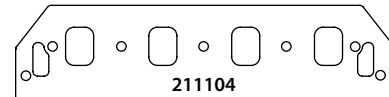
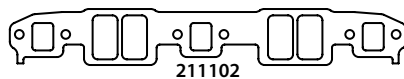
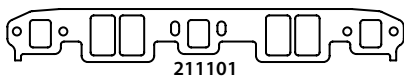

Intake Gaskets

Fitment & Dimensions	Thickness	Accu Seal E Standard Material		Accu Seal Pro Premium Materials	
		Packaged 1 Pair	Dyno Pak	Packaged 1 Pair	Dyno Pak
Chevrolet 23° Stock Port 1.200" x 2.010"	.062"	111101	11101-10	211101	211101-10
	.125"	111106	11106-10	Silicone Bead Sealed Ports	
<i>Also fits Brodix 1K, RR180, RR200 Edelbrock E-Street & Performer</i>					
23° Medium Port 1.250" x 2.200"	.062"	111102	11102-10	211102	211102-10
	.125"	111103	11103-10	Silicone Bead Sealed Ports	
<i>Fits Brodix Track 1, Edelbrock Performer RPM & similar</i>					
23° Large Port 1.300" x 2.250" w/center flow coolant	.062"	111128	11128-10	211128	211128-10
	.125"			Silicone Bead Sealed Ports	
<i>Fits Brodix DS225, -8, -10, -11, 11X & similar</i>					
Extra Large Race Port 1.380" x 2.300" w/center flow coolant	.062"	111107	11107-10	211107	211107-10
	.125"	111113	11113-10	Silicone Bead Sealed Ports	
<i>Fits Brodix -12 Series 15° heads & similar</i>					
GM-Chevrolet Performance 18° 1.265" x 2.180"	.062"				
		111118	11118-10	211118	211118-10
<i>Also fits Brodix 18C</i>					
Chevrolet LT-1 / LT-4 2.25" h. Tapered Port	.062"				
				211127	211127-10
<i>Silicone Bead Sealed Ports</i>					
GM-Chevrolet Performance Vortec SBC 2.10" h. Tapered Port	.062"	111119	11119-10	211119	211119-10
	.125"	111120	11120-10	211120	211120-10
<i>Silicone Bead Sealed Ports</i>					
GM-Chevrolet Performance SB2.2 Mirror Port 1.400" x 1.900" SB2 Valley Cover →	.062"	111114	11114-10	211114	211114-10
	.062"	111115	11115-10	211115	211115-10
<i>Spider (.114) and Valley Cover (.115) gaskets required for Cyl Head Servicing</i>					
GM-Chevrolet Performance Splayed Valve 1.500" x 2.00"	.062"	111104	11104-10	211104	211104-10
	.125"	111105	11105-10	211105	211105-10
<i>Fits Chevrolet symmetrical port splayed valve heads</i>					
Dart-Buick SBC trim to fit thru 1.600" x 2.900"	.062"	111129	11129-10	211129	211129-10
				Silicone Bead Sealed Ports	
<i>Stage II Buick V6 Intake Port Design, requires special Valve Cover & Exhaust gaskets</i>					
Dart Little Chief 1.440" x 2.295"	.062"	111136	11136-10	211136	211136-10
<i>Fits Brodix 1010 series symmetrical port small block</i>					
Brodix 1010 1.500" x 2.300"	.062"	111137	11137-10	211137	211137-10
<i>Fits Brodix 14° canted valve high port small block heads</i>					
Brodix Canted Valve 1.500" x 2.300"	.062"	111130	11130-10	211130	211130-10
<i>Also fits Brodix -15 series</i>					
Brodix -12 Series 1.300" x 2.200"	.062"	111125	11125-10	211125	211125-10
Brodix 12x12 Series 1.410" x 2.500"	.062"	111126	11126-10	211126	211126-10
<i>Fits Brodix 23° Head Hunter with 229 or 234cc runners</i>					
Brodix Head Hunter 1.335" x 2.17"	.062"	111135	11135-10	211135	211135-10
Pro Topline 23° 1.265" x 2.195"	.062"	111123	11123-10	211123	211123-10
Pro Topline 14° 1.365" x 2.195"	.062"	111124	11124-10	211124	211124-10
<i>Intake 'Spider' sets include 4 gaskets for use with phenolic spacers</i>					
Pro Topline 14° Two Piece Intake 1.365" x 2.195" 14° Valley Cover →	.062"	111122	11122-10	211122	211122-10
	.062"	111121	11121-10	211121	211121-10
<i>Intake 'Spider' sets include 4 gaskets for use with phenolic spacers</i>					
Pro Topline 12° Two Piece Intake 1.520" x 2.100" 12° Valley Cover →	.062"	111131	11131-10	211131	211131-10
	.062"	111132	11132-10	211132	211132-10



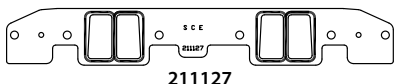

211127

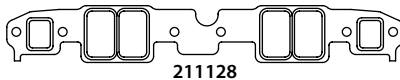

211128

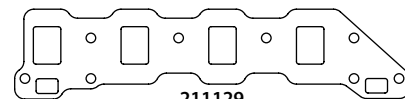

211129

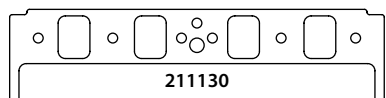

211130

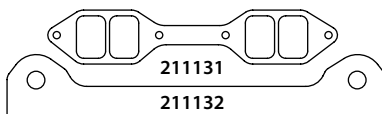

211131

211132

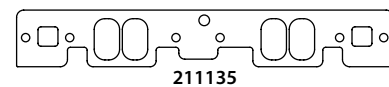

211135

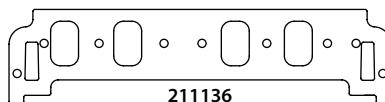

211136

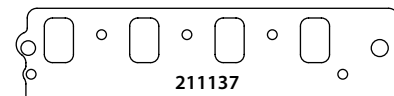

211137

Exhaust Gaskets

Fitment & Dimensions	Accu Seal E <i>Standard Material</i>	E Dyno Pak <i>Bulk Pak of 10 pr</i>	Accu Seal Pro <i>Premium Material</i>	Pro Dyno Pak <i>Bulk Pak of 10 pr</i>	Pro Copper Embossed <i>Raised Sealing Bead</i>	Pro Copper Annealed <i>Flat, Soft .062" Thick</i>
Stock Port 1.355" x 1.485"	111081	11081-10	211181	11181-10	4011	E11186 <i>supersedes 011186</i>
Stock Square Port 1.450" x 1.440"	111080	11080-10	211180	11180-10	4211	E11286 <i>supersedes 011286</i>
D-Port Stock Pattern 1.500" x 1.675"	111082	11082-10	211182	11182-10		
LT-1, LT-4, ZZ-430 Fastburn 1.450" x 1.375"	111087	11087-10	211187	11187-10	4611	E11586 <i>supersedes 011586</i>
Oval Port Headers 1.350" x 1.70"	111088	11088-10	211180	11180-10	4311	
Hooker Style Adapter Plate 1.350" x 1.70"	111084	11084-10	211184	11184-10	4511	
Hooker/Stahl Combination 1.875" Round	111285	11285-10	211285	211285-10		E11486 <i>supersedes 011486</i>
Dart-Buick SBC 1.590" x 1.560"	111286	11286-10	211286	211286-10		
GMCP* 18° 1.740" x 1.600"	111089	11089-10	211189	11189-10	4111	E11986 <i>supersedes 011986</i>
GMCP* Splayed Valve 1.875" Round	111284	11284-10	211284	211284-10		
GMCP* SB2.2 Mirror Port 1.800" x 1.600"	111085	11085-10	211185	11185-10	4811	
AJPE, All Pro, Brodix 12° 1.750" x 1.600"	111083	11083-10	211183	11183-10	4411	E11386 <i>supersedes 011386</i>
Brodix Spread Port 18° 1.875" Round	111283	11283-10	211283	211283-10		E11686 <i>supersedes 011686</i>
AJPE Billet Small Block TF Head 1.97" x 1.76"	111286	11286-10	211286	211286-10		

*GM-Chevrolet Performance · See fitment instructions on page 358



4011



4111



4211

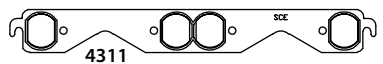

4311



4411

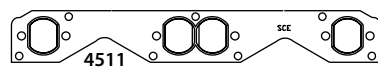

4511



4611

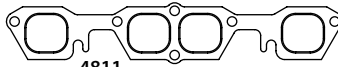

4811

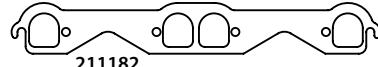

211182



211283

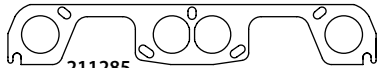

211285

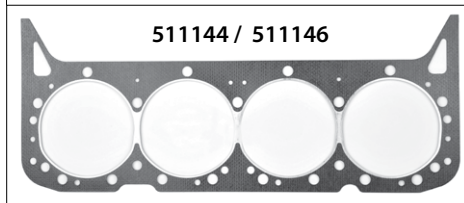

211286

Head Gaskets**Performance Composite Head Gaskets for SBC**

- Fits Chevrolet Small Block 327-383ci except LT-1/LT-4.
- Bore opening: 4.140" round.
- Available in standard or extra thick.
- **511144:** .040" compressed
- **511146:** .060" compressed
- Packaged individually.

Embossed Steel Shim Head Gaskets for SBC

- Fits Chevrolet Small Block 327-383ci except LT-1/LT-4.
- **511091:** Bore opening: 4.090" / Thickness: .015"
- **511162:** Bore opening: 4.165" / Thickness: .021"
- Packaged individually.
- Suggested Use; up to 12:1 compression, no power adders, iron heads.

Embossed Copper Head Gasket for SBC

- Fits Chevrolet Small Block 327-383ci except LT-1/LT-4.
- Bore opening: 4.150"
- Compressed thickness: .020"
- Packaged individually.
- Suggested Use; up to 12:1 compression, no power adders, aluminum heads.

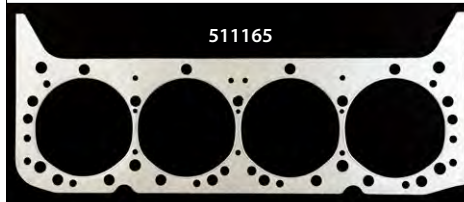
Performance Composite/Steel Head Gasket for 400ci SBC

- Fits Chevrolet Small Block 400ci. with siamesed bores & steam holes.
- Bore opening: 4.160" round.
- Compressed Thickness: .050"
- Packaged individually.

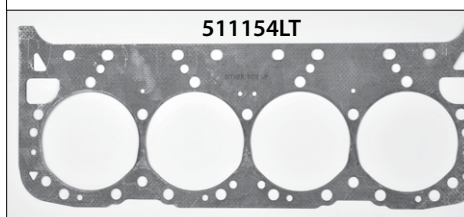
Performance Composite Head Gasket for LT-1/LT-4

- Fits Chevrolet 1992-97 LT-1 & LT-4 Small Block 350ci.
- Bore opening: 4.140" round.
- Compressed Thickness: .040"
- Packaged individually.

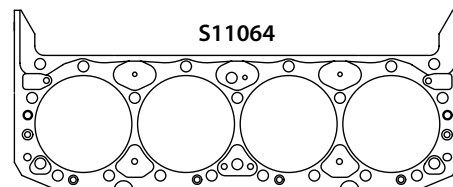
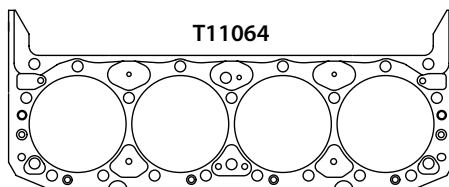
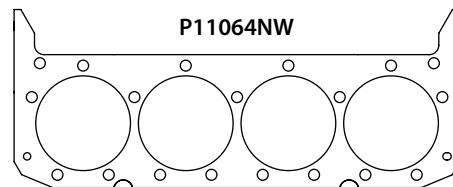
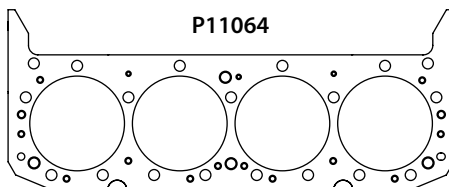
Head Gaskets
Copper Racing Head Gaskets for SBC

Gasket Style	Bore	Thickness								
		.021"	.032"	.043"	.050"	.062"	.072"	.080"	.093"	
Pro Copper for use with o-rings & sealant	3.850" round	P11852	P11853	P11854	P11855	P11856	P11857	P11858	P11859	
Titan sealed coolant passages, for use with o-rings			T11853	T11854	T11855	T11856	T11857	T11858	T11859	
ICS Titan sealed coolant passages, integral combustion o-ring				<i>No Fit: combustion chambers extend past 3.850" round</i>						
Pro Copper for use with o-rings & sealant	4.010" round	P11002	P11003	P11004	P11005	P11006	P11007	P11008	P11009	
Titan sealed coolant passages, for use with o-rings			T11003	T11004	T11005	T11006	T11007	T11008	T11009	
ICS Titan sealed coolant passages, integral combustion o-ring				S11004	S11005	S11006	S11007	S11008	S11009	
Pro Copper for use with o-rings & sealant	4.060" round	P11062	P11063	P11064	P11065	P11066	P11067	P11068	P11069	
Titan sealed coolant passages, for use with o-rings			T11063	T11064	T11065	T11066	T11067	T11068	T11069	
ICS Titan sealed coolant passages, integral combustion o-ring				S11064	S11065	S11066	S11067	S11068	S11069	
Pro Copper for use with o-rings & sealant	4.160" round	P11152	P11153	P11154	P11155	P11156	P11157	P11158	P11159	
Titan sealed coolant passages, for use with o-rings			T11153	T11154	T11155	T11156	T11157	T11158	T11159	
ICS Titan sealed coolant passages, integral combustion o-ring				S11154	S11155	S11156	S11157	S11158	S11159	
Pro Copper for use with o-rings & sealant	4.200" round	P11202	P11203	P11204	P11205	P11206	P11207	P11208	P11209	
Titan sealed coolant passages, for use with o-rings			T11203	T11204	T11205	T11206	T11207	T11208	T11209	
ICS Titan sealed coolant passages, integral combustion o-ring				S11204	S11205	S11206	S11207	S11208	S11209	

"P" prefix supersedes "O" prefix • Packaged in Pairs. • For LT-1/LT-4 reverse flow engines: Use Suffix "LT" • Pro Copper available without water holes: Use Suffix "NW"

ICS Titan™

Built-in combustion seals block lateral flow of combustion pressure.

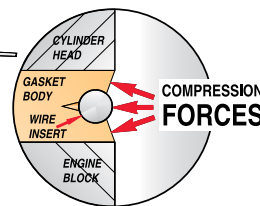
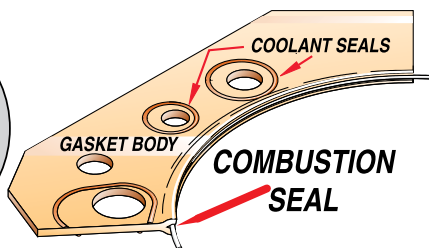
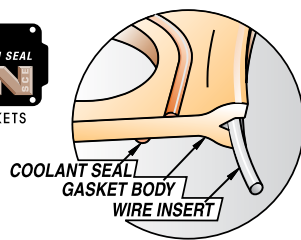

Images show wire o-ring primary seal and self-energizing secondary combustion pressure seal.

Short Block Gaskets & Seals

Application	Qty	Oil Pan Gasket	Front Cover Gaskets TC, WP, FP	Water Pump	Timing Cover Seal	Timing Cover Set	Rear Main Seal	Fuel Pump	Water Outlet
<i>Accu-Seal E standard gasket materials, nitrile or silicone seals.</i>									
Chevrolet 396-454ci Mark IV 1965-90	Each	113090	11300	11301	11302	11303	11305	11306	11308
	Dyno pak	13090-10	1300-10	1301-10	1302-10		1305-10	1306-10	1308-10
	Each	113094	← Fits Moroso stroker wet sump pan						
	Dyno pak	13094-10							
Each	113095	← With extra rod-stroke clearance							
Dyno pak	13095-10								
<i>Accu-Seal Pro premium gasket materials, Fluoroelastomer (Viton®) seals, molded water outlet.</i>									
Each	213090	← 1 pc molded silicone with extra rod-stroke clearance		21302			21305		21308
Dyno pak	213090-10			21302-10			21305-10		21308-10
<i>Accu-Seal E standard gasket materials, nitrile or silicone seals.</i>									
Chevrolet Gen 5 & 6 BBC 1991 & later	Each		11309	11301	11302	11403		11306	11308
	Dyno Pak		1309-10	1301-10	1302-10			1306-10	1308-10
<i>Accu-Seal Pro premium gasket materials, Fluoroelastomer (Viton®) seals, molded water outlet.</i>									
Each	213091	← 1 pc molded silicone rubber		21302			21355		21308
Dyno Pak	213091-10			21302-10			21305-10		21308-10
<i>Accu-Seal E standard gasket materials, nitrile or silicone seals.</i>									
GM DRCE & World Products 'Merlin'	Each	113092	11300	11301	11302		11305		11308
	Dyno pak	13092-10	1300-10	1301-10	1302-10		1305-10		1308-10
<i>Accu-Seal Pro premium gasket materials, Fluoroelastomer (Viton®) seals, molded water outlet.</i>									
Each	213192	← NHRA legal steel core w/ non-stick Red Teflon®		11301	21302		21305		21308
Dyno pak	13192-10			1301-10	21302-10		21305-10		21308-10
<i>Accu-Seal E standard gasket materials, nitrile or silicone seals.</i>									
AJPE 481X	Each	174090			11302		11305		
	Dyno pak	74090-10			1302-10		1305-10		
<i>Accu-Seal Pro premium gasket materials, Fluoroelastomer (Viton®) seals, molded water outlet.</i>									
Each	274090	← NHRA legal steel core w/ non-stick Red Teflon®		21302			21305		
Dyno pak	274090-10			21302-10			21305-10		
<i>Accu-Seal E standard gasket materials, nitrile or silicone seals.</i>									
New Century/KB Olds Block (also fits CN 1040Y with New Century pan rails)	Each	113091	11311		11302		11305		
	Dyno pak	13091-10	1311-10		1302-10		1305-10		
<i>Accu-Seal Pro premium gasket materials, Fluoroelastomer (Viton®) seals, molded water outlet.</i>									
Each	213094	← NHRA legal steel core w/ non-stick Red Teflon®		21302			21305		
Dyno pak	213094-10			21302-10			21305-10		
<i>Accu-Seal E standard gasket materials, nitrile or silicone seals.</i>									
Donovan 700	Each	113093	11310	11301	11302		11305		
	Dyno pak	13093-10	1310-10	1301-10	1302-10		1305-10		
<i>Accu-Seal Pro premium gasket materials, Fluoroelastomer (Viton®) seals, molded water outlet.</i>									
Each	213093	← NHRA legal steel core w/ non-stick Red Teflon®		21302			21305		
Dyno pak	213093-10			21302-10			21305-10		

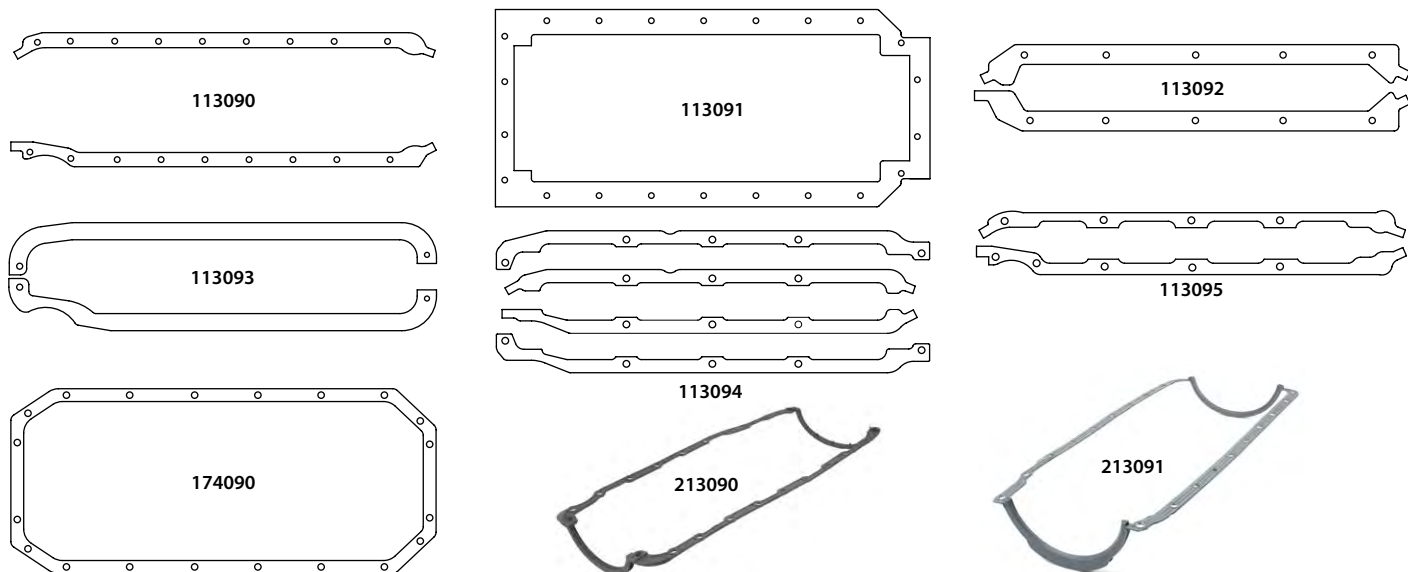

Valve Cover Gaskets

Fitment	Qty	Cork, Hi Density 5/16" Thick <i>Street/Strip</i>	Laminated Silicone Cork 1/8" Thick <i>Racing/Hi Vacuum</i>	Laminated Silicone Cork 1/4" Thick <i>Racing/Hi Vacuum</i>	Molded Silicone Rubber <i>Street Performance</i>	Steel Core Teflon® Coated .078" Thick <i>Severe Duty</i>
Chevrolet Pattern Big Block (all Mk IV, Gen 5, Gen 6)		<i>7 bolts 3 over 4 pattern</i>				
	1pr	113076	213075	213076	213077	213078
	Dyno Pak	13076-10	213075-10	213076-10	213077-10	213078-10
Dart Big Chief, Brodix Big Duke, Pontiac Super Duty		<i>8 bolts 4 over 4 pattern</i>				
	1pr		218075	218076		218078
	Dyno Pak		218075-10	218076-10		218078-10
Reher & Morrison 'Raptor'		<i>8 bolts 4 over 4 pattern</i>				
	1pr		218175	218176		218178
	Dyno Pak		218175-10	218176-10		218178-10
AJPE 481X		<i>7 bolts 3 over 4 bolt pattern Also fits GM DRCE 2 & 3</i>				
	1pr		274074	274076		274175
	Dyno Pak		274074-10	274076-10		274175-10
AJPE 4.9" NHRA P/S		<i>7 bolts 3 over 4 bolt pattern</i>				
	1pr		215175	215176		215178
	Dyno Pak		215175-10	215176-10		215178-10
AJPE 5" IHRA P/S		<i>7 bolts 3 over 4 bolt pattern</i>				
	1pr		255175	255176		255178
	Dyno Pak		255175-10	255176-10		255178-10
Fulton/CFE 5"		<i>6 bolts 2 over 4 pattern fits Brodix BP, PB 5000 series 5" bore spacing heads</i>				
	1pr		250175	250176		250178
	Dyno Pak		250175-10	250176-10		250178-10
Brodix PB 5000 5"		<i>6 bolts 2 over 4 pattern fits Brodix BP, PB 5000 series 5" bore spacing heads</i>				
	1pr		295175	295176		295178
	Dyno Pak		295175-10	295176-10		295178-10
Brodix/Eicke 5"		<i>8 bolts 4 over 4 pattern</i>				
	1pr		275375	275376		275378
	Dyno Pak		275375-10	275376-10		275378-10
Sonny's 5.0" Billet/813ci		<i>Fits Sonny's 5.0" Billet & 5.0" 813ci</i>				
	1pr		240175	240176		240178
	Dyno Pak		240175-10	240176-10		240178-10
Sonny's 5.3"		<i>Fits Sonny's 5.3" bore center heads</i>				
	1pr		243175	243176		243178
	Dyno Pak		243175-10	243176-10		243178-10

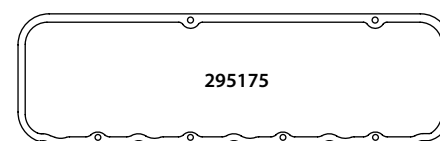
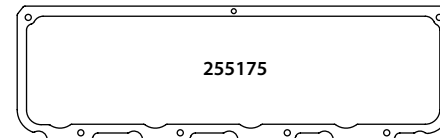
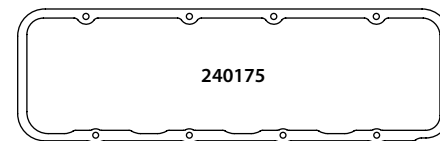
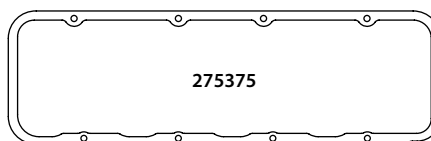
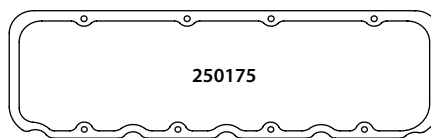
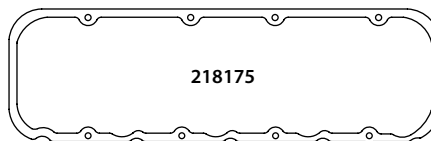
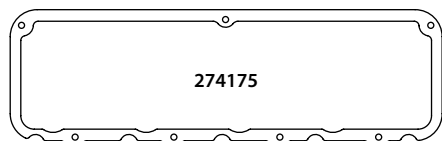
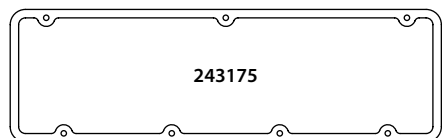
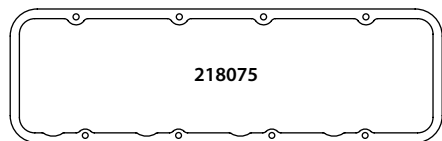
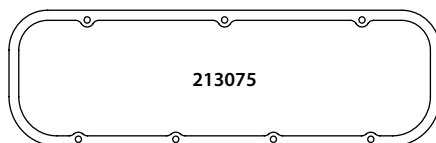
Standard BBC Valve Cover Gaskets

BBC Racing Derivative Valve Cover Gaskets

Intake Gaskets

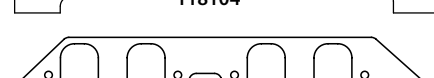
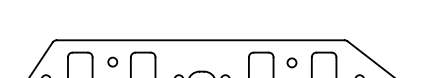
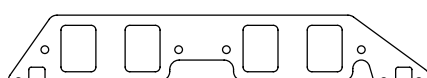
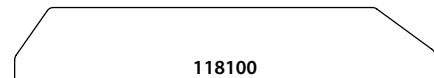
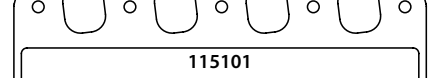
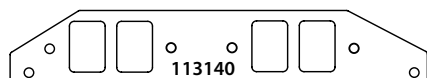
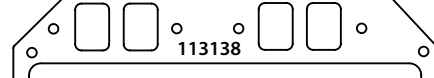
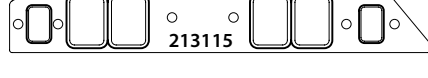
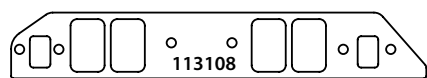
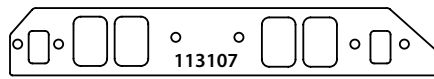
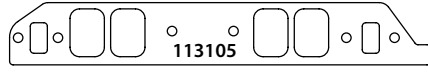
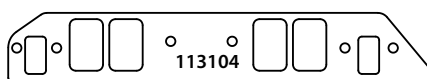
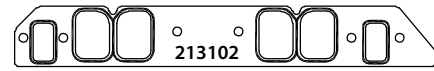
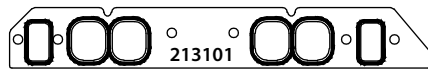
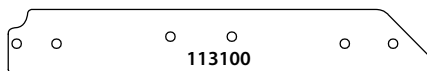
Fitment & Dimensions	Thickness	Accu Seal E Standard Material		Accu Seal Pro Premium Materials	
		Packaged 1 Pair	Dyno Pak	Packaged 1 Pair	Dyno Pak
BBC Intake Blank		Standard BBC outline shape with bolt holes, no intake or water ports			
	.062"	113100	13100-10	213100	213100-10
Raised Port Intake Blank		Generic raised outline shape, no bolts holes, no ports			
	.062"	118100	18100-10	218100	218100-10
	.125"	118125	18125-10		
BBC Stock Oval Port 1.750" x 2.00"		Fits Chevrolet oval port, Edelbrock 454-O, Brodix FF-010 and similar heads			
	.062"	113101	13101-10	213101	213101-10
	.125"	113106	13106-10	Silicone Bead Sealed Ports	
BBC Hi-Perf Rectangle 1.750" x 2.550"		Fits Chevrolet HP rectangle, Edelbrock RPM 454, Brodix JJ294 and similar heads			
	.062"	113102	13102-10	213102	213102-10
	.125"	113103	13103-10	Silicone Bead Sealed Ports	
BBC Large Rectangle 1.800" x 2.500"		Fits Dart 360, Edelbrock Victor, Brodix BB1 thru 4 & similar w/rect ports & No Top Bolts			
	.062"	113115	13115-10	213115	213115-10
	.125"	113116	13116-10	Silicone Bead Sealed Ports	
Brodix BB-3 Xtra Oval 1.820" x 2.540"		Fits BB-3 Xtra Oval, CNC ported by Brodix			
	.062"	113105	13105-10	213105	213105-10
Dart Big M 1.720" x 2.720"		X Large rectangle intake ports, no top bolts			
	.062"	113104	13104-10	213104	213104-10
CFE BMF 405cc 1.800" x 2.800"		Port matched to CFE finished CNC ported head			
	.062"	113108	13108-10	213108	213108-10
RHS Pro Action 320/360 1.725" x 2.450"		Port matched to RHS finished port size			
	.062"	113107	13107-10	213107	213107-10
Dart Big Chief Rect. Port 1.840" x 2.695"		Fits Dart Big Chief & Brodix Big Duke cast heads with rectangle ports			
	.062"	118101	18101-10	218101	218101-10
	.125"	118106	18106-10		
Dart Big Chief CNC trim to fit		Fits Dart Big Chief CNC heads, sufficient material to port match any CNC port			
	.062"	118108	18108-10	218108	218108-10
Dart Big Chief Small Oval 1.650" x 2.450"					
	.062"	118102	18102-10	218102	218102-10
Dart Big Chief Large Oval 1.950" x 2.650"					
	.062"	118104	18104-10	218104	218104-10
	.125"	118105	18105-10		
Brodix/Pontiac Super Duty 1.920" x 2.700"		Siamesed ports, fits casting number 5427			
	.062"	113140	13140-10	213140	213140-10
Pontiac Super Duty 1.750" x 2.450"		Raised siamesed ports, fits casting number 9875			
	.062"	113138	13138-10	213138	213138-10
AJPE NHRA 4.9" Pro Stock 2.190" x 2.540"		Port matched to AJPE CNC ported head			
	.062"	115101	15101-10	215101	215101-10
AJPE 5.0" 2.160" x 2.700"		Port matched to AJPE CNC ported head			
	.062"	155102	55102-10	255102	255102-10
Brodix PB 5000 5.0" 2.025" x 2.750"		Fits Brodix PB, BP 5000 series 5" bore center heads			
	.062"	195101	95101-10	295101	295101-10
Sonny's 813 5.0" Bore Center 2.185" x 2.645"		Fits Sonny's 813 & Billet 5" bore center heads			
	.062"	140101	40101-10	240101	240101-10



Exhaust Gaskets

Fitment & Dimensions	Accu Seal E <i>Standard Material</i>	E Dyno Pak <i>Bulk Pak of 10 pr</i>	Accu Seal Pro <i>Premium Material</i>	Pro Dyno Pak <i>Bulk Pak of 10 pr</i>	Pro Copper Embossed <i>Raised Sealing Bead</i>	Pro Copper Annealed <i>Flat, Soft .062" Thick</i>
Stock Round Port 1.850" Round	113080	13080-10	213180	13180-10	4013	E13186 <i>supersedes 013186</i>
<i>Fits up to 1.875" o.d. round port headers</i>						
Large Round Port 2.00" Round	113081	13081-10	213181	13181-10	4313	E13286 <i>supersedes 013286</i>
<i>Fits up to 2.125" o.d. round port headers</i>						
XL Round Port 2.250" Round	113084	13084-10	213184	13184-10	4213	E18186 <i>supersedes 018186</i>
<i>Fits up to 2.375" o.d. racing headers</i>						
Stock Square Port 1.875" x 1.800"	113082	13082-10	213182	13182-10	4113	E13187 <i>supersedes 013187</i>
<i>Fits stock cast iron manifold, Hedman #2455 and similar square port headers</i>						
Large Square Port 2.025" x 2.025"	113083	13083-10	213183	13183-10		
<i>Fits cast aluminum marine water cooled manifolds and similar large square port headers</i>						
Chevrolet 502/572 1.945" x 1.685"	113085	13085-10	213185	213185-10	4413	
<i>Raised "D" port location also fits Edelbrock Victor, RHS 320/360</i>						
AJPE 481X 2.500" Round	174080	74080-10	274080	274080-10	4074	
<i>Also fits GM DRCE-1, seals 2.500" i.d racing headers</i>						
DRCE 2-3 NHRA Pro Stock 2.320" Round	176080	76080-10	276080	276080-10	4176	
<i>2.320" round gasket opening seals up to 2.5" header opening</i>						
AJPE 4.9" NHRA Pro Stock 2.170" x 1.960"	115081	15081-10	215081	215081-10	4015	
<i>Gasket matches cylinder head port & seals 2.5" header opening</i>						
AJPE 5" IHRA Pro Stock 2.400" x 2.0" Oval	155081	55081-10	255181	55181-10		
<i>Gasket matches cylinder head port & seals 2.5" header opening</i>						
Brodix PB 5000 2.25" Round	195085	95085-10	295185	295185-10		
<i>Fits Brodix PB, BP 5000 series 5.0" head port & seals up to 2.5" header opening</i>						
Sonny's 813 5.0" Bore Center 2.185" x 2.645"	140081	40081-10	240081	240081-10	4040	
<i>Fits Sonny's 813 & Billet 5" bore center heads</i>						
Sonny's 5.3" 2.675" Round	143080	43080-10	243080	243080-10		

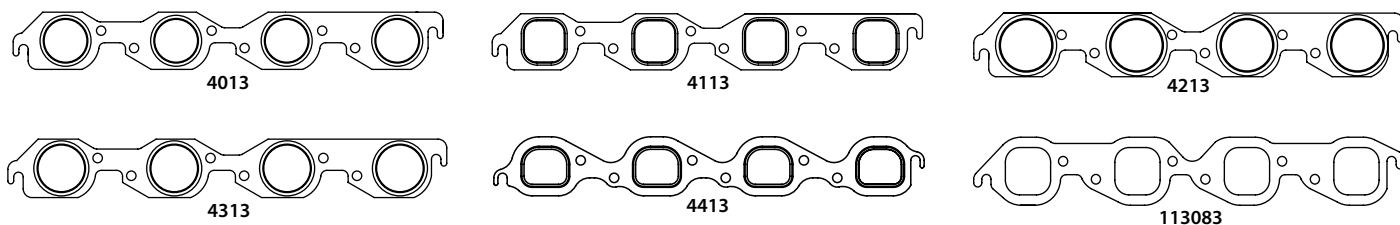
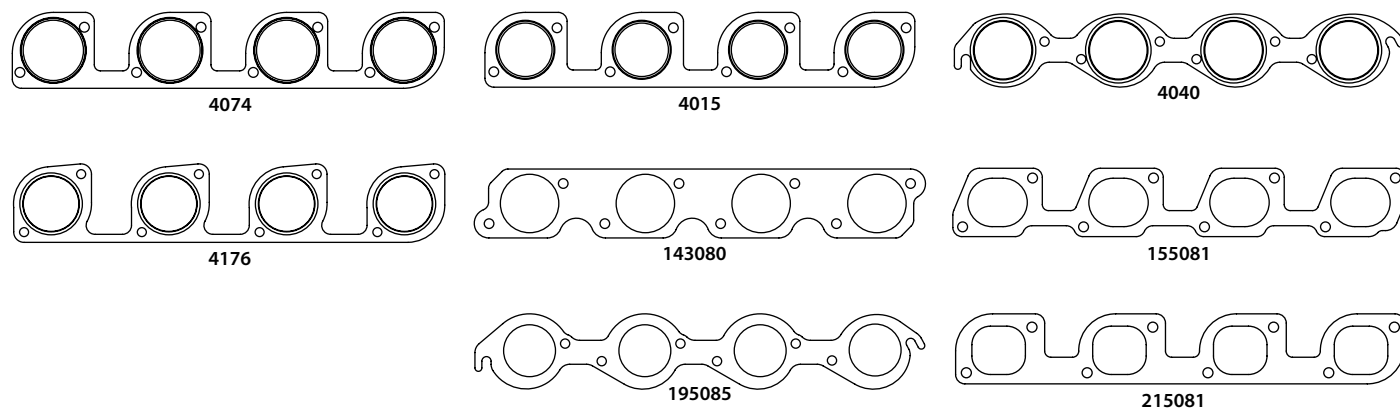
See fitment instructions on page 358
Standard BBC Exhaust Patterns

BBC Racing Derivative Exhaust Patterns

Head Gaskets

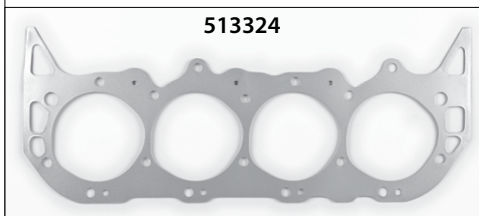
Performance Composite Head Gasket Mark IV Small Bore



- Fits Mark 4 style BBC up to 4.320" bore opening
- Bore opening: 4.320"
- Thickness: .040" compressed
- Packaged individually

Performance Composite Head Gasket for Mark IV Big Bore

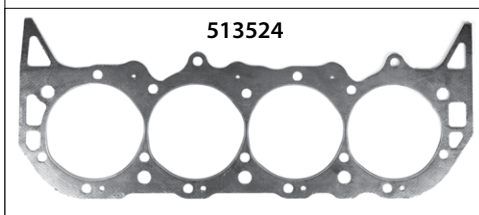

- Fits Mark 4 style BBC up to 4.520" bore opening.
- Bore opening: 4.520".
- Thickness: .040" compressed.
- Packaged individually.

Embossed Steel Shim Head Gasket for BBC



- Fits Mark 4 style BBC up to 4.320" bore opening.
- Bore opening: 4.320".
- Thickness: .020"
- Packaged individually.
- Suggested Use; up to 12:1 compression, no power adders, iron heads.

Performance Composite Head Gasket for Gen 5-6 Small Bore

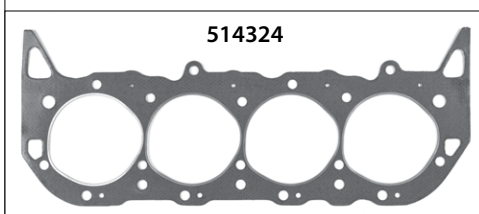

- Fits 1991-95 Gen 5 BBC up to 4.320" bore opening.
- Bore opening: 4.320".
- Thickness: .040" compressed.
- Packaged individually.

Performance Composite Head Gasket for Gen 6 Big Bore

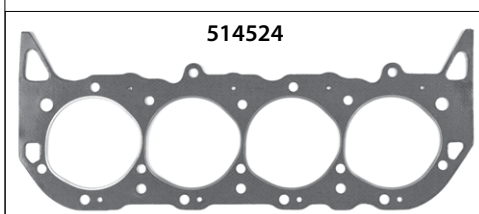

- Fits 1991 & later Gen 5-6 BBC up to 4.520" bore opening.
- Bore opening: 4.520".
- Thickness: .040" compressed.
- Packaged individually.

Performance Composite Head Gasket for Gen 6 Big Bore

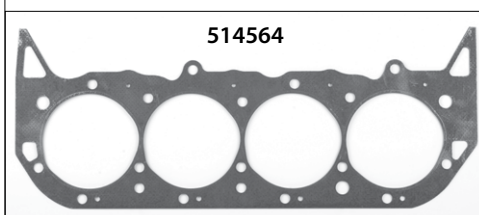

- Fits GM 572 Crate and other Gen 6 BBC up to 4.560" bore opening.
- Bore opening: 4.560".
- Thickness: .040" compressed.
- Packaged individually.

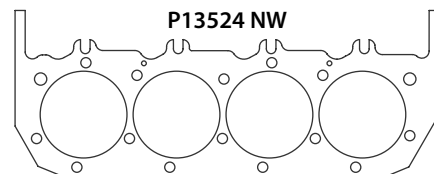
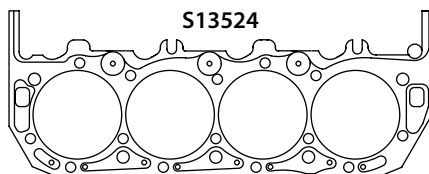
Head Gaskets
Copper Racing Head Gaskets for Mark IV Style BBC

Gasket Style	Bore	Thickness							
		.021"	.032"	.043"	.050"	.062"	.072"	.080"	.093"
Pro Copper for use with o-rings & sealant	4.250" round	P13252	P13253	P13254	P13255	P13256	P13257	P13258	P13259
Titan sealed coolant passages, for use with o-rings			T13253	T13254	T13255	T13256	T13257	T13258	T13259
ICS Titan sealed coolant passages, integral combustion o-ring		<i>No Fit: combustion chambers extend past 4.440" round</i>							
Pro Copper for use with o-rings & sealant	4.320" round	P13322	P13323	P13324	P13325	P13326	P13327	P13328	P13329
Titan sealed coolant passages, for use with o-rings			T13323	T13324	T13325	T13326	T13327	T13328	T13329
ICS Titan sealed coolant passages, integral combustion o-ring		<i>No Fit: combustion chambers extend past 4.440" round</i>							
Pro Copper for use with o-rings & sealant	4.380" round	P13382	P13383	P13384	P13385	P13386	P13387	P13388	P13389
Titan sealed coolant passages, for use with o-rings			T13383	T13384	T13385	T13386	T13387	T13388	T13389
ICS Titan sealed coolant passages, integral combustion o-ring		<i>No Fit: combustion chambers extend past 4.440" round</i>							
Pro Copper for use with o-rings & sealant	4.440" round	P13442	P13443	P13444	P13445	P13446	P13447	P13448	P13449
Titan sealed coolant passages, for use with o-rings			T13443	T13444	T13445	T13446	T13447	T13448	T13449
ICS Titan sealed coolant passages, integral combustion o-ring		<i>No Fit: combustion chambers extend past 4.440" round</i>							
Pro Copper for use with o-rings & sealant	4.520" round	P13522	P13523	P13524	P13525	P13526	P13527	P13528	P13529
Titan sealed coolant passages, for use with o-rings			T13523	T13524	T13525	T13526	T13527	T13528	T13529
ICS Titan sealed coolant passages, integral combustion o-ring				S13524	S13525	S13526	S13527	S13528	S13529
Pro Copper for use with o-rings & sealant	4.570" round	P13572	P13573	P13574	P13575	P13576	P13577	P13578	P13579
Titan sealed coolant passages, for use with o-rings			T13573	T13574	T13575	T13576	T13577	T13578	T13579
ICS Titan sealed coolant passages, integral combustion o-ring				S13574	S13575	S13576	S13577	S13578	S13579
Pro Copper for use with o-rings & sealant	4.630" round	P13622	P13623	P13624	P13625	P13626	P13627	P13628	P13629
Titan sealed coolant passages, for use with o-rings			T13623	T13624	T13625	T13626	T13627	T13628	T13629
ICS Titan sealed coolant passages, integral combustion o-ring				S13624	S13625	S13626	S13627	S13628	S13629

Packaged in Pairs. • Pro Copper available without water holes: Use Suffix "NW" • "P" prefix supersedes "0" prefix

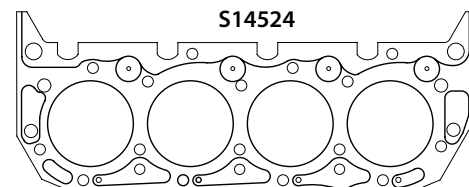
Copper Racing Head Gaskets for Gen 5-6 BBC

Gasket Style	Bore	Thickness							
		.021"	.032"	.043"	.050"	.062"	.072"	.080"	.093"
Pro Copper for use with o-rings & sealant	4.320" round	P14322	P14323	P14324	P14325	P14326	P14327	P14328	P14329
Titan sealed coolant passages, for use with o-rings			T14323	T14324	T14325	T14326	T14327	T14328	T14329
ICS Titan sealed coolant passages, integral combustion o-ring		<i>No Fit: combustion chambers extend past 4.440" round</i>							
Pro Copper for use with o-rings & sealant	4.380" round	P14382	P14383	P14384	P14385	P14386	P14387	P14388	P14389
Titan sealed coolant passages, for use with o-rings			T14383	T14384	T14385	T14386	T14387	T14388	T14389
ICS Titan sealed coolant passages, integral combustion o-ring		<i>No Fit: combustion chambers extend past 4.440" round</i>							
Pro Copper for use with o-rings & sealant	4.440" round	P14442	P14443	P14444	P14445	P14446	P14447	P14448	P14449
Titan sealed coolant passages, for use with o-rings			T14443	T14444	T14445	T14446	T14447	T14448	T14449
ICS Titan sealed coolant passages, integral combustion o-ring		<i>No Fit: combustion chambers extend past 4.440" round</i>							
Pro Copper for use with o-rings & sealant	4.520" round	P14522	P14523	P14524	P14525	P14526	P14527	P14528	P14529
Titan sealed coolant passages, for use with o-rings			T14523	T14524	T14525	T14526	T14527	T14528	T14529
ICS Titan sealed coolant passages, integral combustion o-ring				S14524	S14525	S14526	S14527	S14528	S14529
Pro Copper for use with o-rings & sealant	4.570" round	P14572	P14573	P14574	P14575	P14576	P14577	P14578	P14579
Titan sealed coolant passages, for use with o-rings			T14573	T14574	T14575	T14576	T14577	T14578	T14579
ICS Titan sealed coolant passages, integral combustion o-ring				S14574	S14575	S14576	S14577	S14578	S14579
Pro Copper for use with o-rings & sealant	4.630" round	P14622	P14623	P14624	P14625	P14626	P14627	P14628	P14629
Titan sealed coolant passages, for use with o-rings			T14623	T14624	T14625	T14626	T14627	T14628	T14629
ICS Titan sealed coolant passages, integral combustion o-ring				S14624	S14625	S14626	S14627	S14628	S14629

Packaged in Pairs. • "P" prefix supersedes "0" prefix

Head Gaskets

4.840" Bore Center Racing Specific Engines

Copper Head Gaskets for AJPE 481X, 4.840" Bore Center Alcohol Racing Block

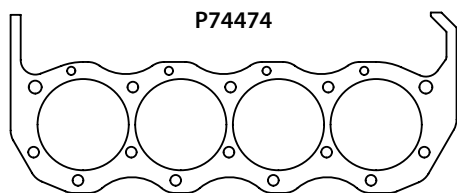

Gasket Style	Bore	Thickness							
		.043"	.050"	.062"	.072"	.080"	.093"	.100"	.110"
Pro Copper for use with O-rings & Receiver Grooves	4.380"	P74384	P74385	P74386	P74387	P74388	P74389	P74380	P74381
Pro Copper for use with O-rings & Receiver Grooves	4.440"	P74444	P74445	P74446	P74447	P74448	P74449	P74440	P74441
Pro Copper for use with O-rings & Receiver Grooves	4.470"	P74474	P74475	P74476	P74477	P74478	P74479	P74470	P74471
Pro Copper for use with O-rings & Receiver Grooves	4.520"	P74524	P74525	P74526	P74527	P74528	P74529	P74520	P74521

"P" prefix supersedes "O" prefix • Packaged in Pairs

Copper Head Gaskets for DRCE-1, 4.840" Bore Center Racing Blocks

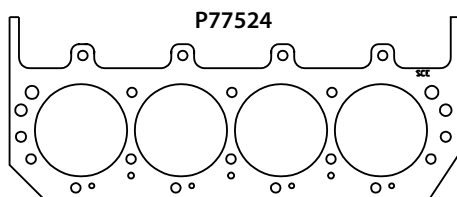

Gasket Style	Bore	Thickness							
		.043"	.050"	.062"	.072"	.080"	.093"	.100"	.110"
Pro Copper for use with O-rings	4.520"	P77524	P77525	P77526	P77527	P77528	P77529	P77520	P77521
Pro Copper for use with O-rings	4.570"	P77574	P77575	P77576	P77577	P77578	P77579	P77570	P77571
Pro Copper for use with O-rings	4.630"	P77624	P77625	P77626	P77627	P77628	P77629	P77620	P77621

"P" prefix supersedes "O" prefix • Packaged in Pairs

4.900" Bore Center Racing Specific Engines

Copper Head Gaskets for AJPE Pro Stock 4.9" Bore Center Racing Blocks

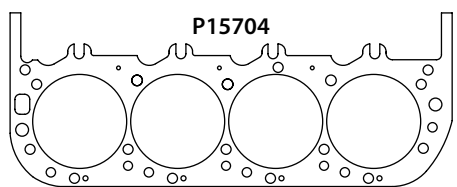

Gasket Style	Bore	Thickness							
		.043"	.050"	.062"	.072"	.080"	.093"	.100"	.110"
Pro Copper for use with O-rings	4.520"	P15524	P15525	P15526	P15527	P15528	P15529	P15520	P15521
Pro Copper for use with O-rings	4.570"	P15574	P15575	P15576	P15577	P15578	P15579	P15570	P15571
Pro Copper for use with O-rings	4.630"	P15624	P15625	P15626	P15627	P15628	P15629	P15620	P15621
Pro Copper for use with O-rings	4.700"	P15704	P15705	P15706	P15707	P15708	P15709	P15700	P15701

"P" prefix supersedes "O" prefix • Packaged in Pairs

Copper Head Gaskets for BBC Bolt Pattern, 4.9" Bore Center Racing Blocks

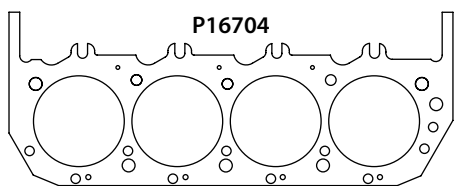

Gasket Style	Bore	Thickness							
		.043"	.050"	.062"	.072"	.080"	.093"	.100"	.110"
Pro Copper for use with O-rings & Receiver Grooves	4.520"	P16524	P16525	P16526	P16527	P16528	P16529	P16520	P16521
Pro Copper for use with O-rings & Receiver Grooves	4.570"	P16574	P16575	P16576	P16577	P16578	P16579	P16570	P16571
Pro Copper for use with O-rings & Receiver Grooves	4.630"	P16624	P16625	P16626	P16627	P16628	P16629	P16620	P16621
Pro Copper for use with O-rings & Receiver Grooves	4.700"	P16704	P16705	P16706	P16707	P16708	P16709	P16700	P16701

"P" prefix supersedes "O" prefix • Packaged in Pairs

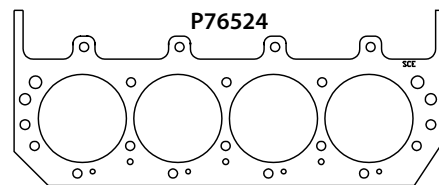
Head Gaskets
Copper Head Gaskets for DRCE-2 & 3, 4.9" Bore Center Racing Blocks

Gasket Style	Bore	Thickness							
		.043"	.050"	.062"	.072"	.080"	.093"	.100"	.110"
Pro Copper for use with O-rings	4.520"	P76524	P76525	P76526	P76527	P76528	P76529	P76520	P76521
Pro Copper for use with O-rings	4.570"	P76574	P76575	P76576	P76577	P76578	P76579	P76570	P76571
Pro Copper for use with O-rings	4.630"	P76624	P76625	P76626	P76627	P76628	P76629	P76620	P76621
Pro Copper for use with O-rings	4.700"	P76704	P76705	P76706	P76707	P76708	P76709	P76700	P76701

"P" prefix supersedes "0" prefix • Packaged in Pairs

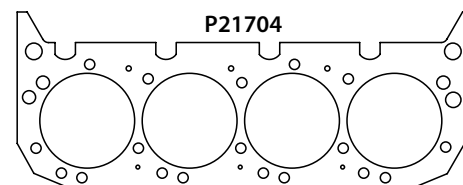
5.0" Bore Center Racing Specific Engines
Copper Head Gaskets for BBC Bolt Pattern 5.0" Bore Center Racing Blocks

Gasket Style	Bore	Thickness							
		.043"	.050"	.062"	.072"	.080"	.093"	.100"	.110"
Pro Copper for use with O-rings	4.630"	P21624	P21625	P21626	P21627	P21628	P21629	P21620	P21621
Pro Copper for use with O-rings	4.700"	P21704	P21705	P21706	P21707	P21708	P21709	P21700	P21701
Pro Copper for use with O-rings	4.770"	P21774	P21775	P21776	P21777	P21778	P21779	P21770	P21771

"P" prefix supersedes "0" prefix • Packaged in Pairs

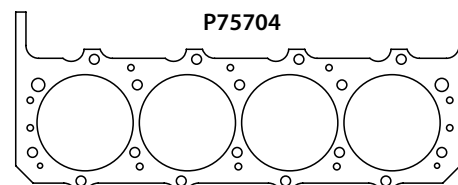
Copper Head Gaskets for Olds Bolt Pattern 5.0" Bore Center Racing Blocks

Gasket Style	Bore	Thickness							
		.043"	.050"	.062"	.072"	.080"	.093"	.100"	.110"
Pro Copper for use with O-rings	4.630"	P75624	P75625	P75626	P75627	P75628	P75629	P75620	P75621
Pro Copper for use with O-rings	4.700"	P75704	P75705	P75706	P75707	P75708	P75709	P75700	P75701
Pro Copper for use with O-rings	4.770"	P75774	P75775	P75776	P75777	P75778	P75779	P75770	P75771

"P" prefix supersedes "0" prefix • Packaged in Pairs

Copper Head Gaskets for Fulton 5.0" Racing Blocks

- Note: Valley bolt locations unique to Fulton style 5.0" block.
- Gaskets not interchangeable with Olds bolt pattern 5.0" blocks.

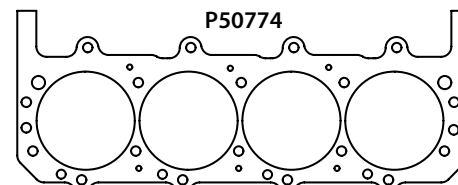

Gasket Style	Bore	Thickness							
		.043"	.050"	.062"	.072"	.080"	.093"	.100"	.110"
Pro Copper for use with O-rings	4.630"	P50624	P50625	P50626	P50627	P50628	P50629	P50620	P50621
Pro Copper for use with O-rings	4.700"	P50704	P50705	P50706	P50707	P50708	P50709	P50700	P50701
Pro Copper for use with O-rings	4.770"	P50774	P50775	P50776	P50777	P50778	P50779	P50770	P50771

"P" prefix supersedes "0" prefix • Packaged in Pairs

Head Gaskets

Copper Head Gaskets for Sonny's Original 5.0" Bore Center Racing Blocks

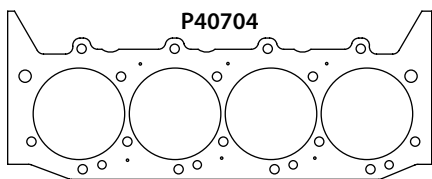

- Note: Valley bolts at 4.850", center to center.
- Gaskets are not interchangeable with Sonny's 5.0" Billet block

Gasket Style	Bore	Thickness							
		.043"	.050"	.062"	.072"	.080"	.093"	.100"	.110"
Pro Copper for use with O-rings	4.630"	P40624	P40625	P40626	P40627	P40628	P40629	P40620	P40621
Pro Copper for use with O-rings	4.700"	P40704	P40705	P40706	P40707	P40708	P40709	P40700	P40701
Pro Copper for use with O-rings	4.770"	P40774	P40775	P40776	P40777	P40778	P40779	P40770	P40771

"P" prefix supersedes "O" prefix • Packaged in Pairs

Copper Head Gaskets for Sonny's 5.0" Billet Racing Blocks

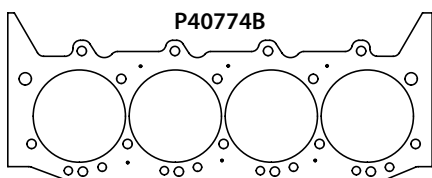

- Note: Valley bolt locations are 10° offset from bore centerlines.
- Gaskets are not interchangeable with Sonny's Original 5.0" block.

Gasket Style	Bore	Thickness							
		.043"	.050"	.062"	.072"	.080"	.093"	.100"	.110"
Pro Copper for use with O-rings	4.630"	P40624B	P40625B	P40626B	P40627B	P40628B	P40629B	P40620B	P40621B
Pro Copper for use with O-rings	4.700"	P40704B	P40705B	P40706B	P40707B	P40708B	P40709B	P40700B	P40701B
Pro Copper for use with O-rings	4.770"	P40774B	P40775B	P40776B	P40777B	P40778B	P45779B	P45770B	P45771B

"P" prefix supersedes "O" prefix • Packaged in Pairs

Copper Head Gaskets for AJPE 5.0" Pro Street Racing Blocks

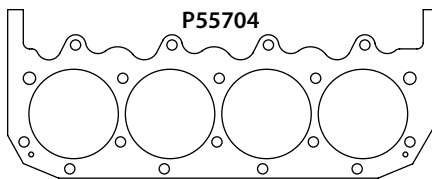

Gasket Style	Bore	Thickness							
		.043"	.050"	.062"	.072"	.080"	.093"	.100"	.110"
Pro Copper for use with O-rings	4.630"	P55624	P55625	P55626	P55627	P55628	P55629	P55620	P55621
Pro Copper for use with O-rings	4.700"	P55704	P55705	P55706	P55707	P55708	P55709	P55700	P55701
Pro Copper for use with O-rings	4.770"	P55774	P55775	P55776	P55777	P55778	P55779	P55770	P55771

"P" prefix supersedes "O" prefix • Packaged in Pairs

Copper Head Gaskets for Brodix PB 5000 Series 5.0" Bore Center Racing Blocks

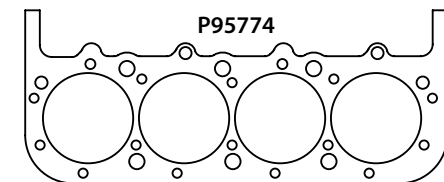

Gasket Style	Bore	Thickness							
		.043"	.050"	.062"	.072"	.080"	.093"	.100"	.110"
Pro Copper for use with O-rings	4.630"	P95624	P95625	P95626	P95627	P95628	P95629	P95620	P95621
Pro Copper for use with O-rings	4.700"	P95704	P95705	P95706	P95707	P95708	P95709	P95700	P95701
Pro Copper for use with O-rings	4.770"	P95774	P95775	P95776	P95777	P95778	P95779	P95770	P95771

"P" prefix supersedes "O" prefix • Packaged in Pairs

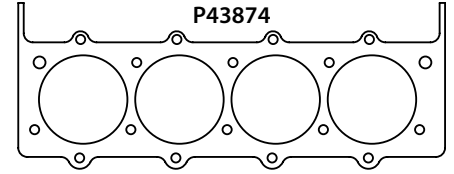
Head Gaskets
5"+ Bore Center Racing Specific Engines
Copper Head Gaskets for Sonny's 5.3" Bore Center Racing Blocks

Gasket Style	Bore	Thickness							
		.043"	.050"	.062"	.072"	.080"	.093"	.100"	.110"
Pro Copper for use with O-rings	4.800"	P43804	P43805	P43806	P43777	P43808	P43809	P43800	P43801
Pro Copper for use with O-rings	4.830"	P43834	P43835	P43836	P43837	P43838	P43839	P43830	P43831
Pro Copper for use with O-rings	4.870"	P43874	P43875	P43876	P43877	P43878	P43879	P43870	P43871
Pro Copper for use with O-rings	5.020"	P43024	P43025	P43026	P43027	P43028	P43029	P43020	P43021

"P" prefix supersedes "O" prefix • Packaged in Pairs

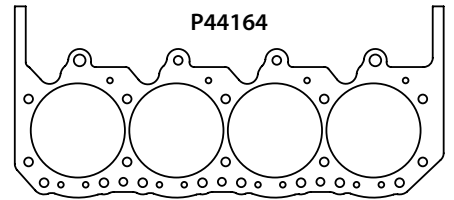
Copper Head Gaskets for Sonny's 5.4" Bore Center Racing Blocks

Gasket Style	Bore	Thickness							
		.043"	.050"	.062"	.072"	.080"	.093"	.100"	.110"
Pro Copper for use with O-rings	4.830"	P44834	P44835	P44836	P44837	P44838	P44839	P44830	P44831
Pro Copper for use with O-rings	4.870"	P44874	P44875	P44876	P44877	P44878	P44879	P44870	P44871
Pro Copper for use with O-rings	5.020"	P44024	P44025	P44026	P44027	P44028	P44029	P44020	P44021
Pro Copper for use with O-rings	5.160"	P44164	P44165	P44166	P44167	P44168	P44169	P44160	P44161

"P" prefix supersedes "O" prefix • Packaged in Pairs

Short Block Gaskets & Seals

Application	Qty	Oil Pan Gasket	Front Cover Gaskets TC, WP, FP	Water Pump	Timing Cover Seal	Timing Cover Set	Rear Main Seal	Fuel Pump	Water Outlet	
<i>Accu-Seal E standard gasket materials, nitrile or silicone seals.</i>										
1970-90 318-340ci	Each	169090	16900	16901	16902	16903	16904	16906	16908	
	Dyno pak	69090-10	6900-10	6901-10	6902-10		6904-10	6906-10	6908-10	
<i>Accu-Seal E standard gasket materials, nitrile or silicone seals.</i>										
1991-2003 318ci All	Each		16900	16901	16902	16903	16904	16906	16908	
	Dyno Pak		6900-10	6901-10	6902-10		6904-10	6906-10	6908-10	
	<i>Accu-Seal Pro premium gasket materials, Fluoroelastomer (Viton®) seals, molded water outlet.</i>									
	Each	269090 1 pc Molded Silicone Rubber				26902				
	Dyno Pak	211090-10			26902-10					
<i>Accu-Seal E standard gasket materials, nitrile or silicone seals.</i>										
1974-90 360ci	Each	169091	16900	16901	16902	16903	16905	16906	16908	
	Dyno pak	69091-10	6900-10	6901-10	6902-10		6905-10	6906-10	6908-10	
<i>Accu-Seal Pro premium gasket materials, Fluoroelastomer (Viton®) seals, molded water outlet.</i>										
1991-2003 360ci All	Each	269091 1 pc Molded Silicone Rubber			26902					
	Dyno pak	269091-10			26902-10					
<i>Accu-Seal E standard gasket materials, nitrile or silicone seals.</i>										
"A" Aluminum Race Blocks	Each	170091	17000							
	Dyno pak	70091-10	7000-10							
<i>Accu-Seal Pro premium gasket materials, Fluoroelastomer (Viton®) seals, molded water outlet.</i>										
"A" Aluminum Race Blocks	Each	270091 Steel Core			26902		16904			
	Dyno pak	270091-10			26902-10		6904-10			

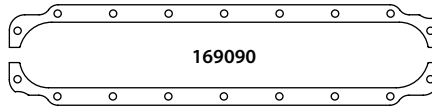

Valve Cover Gaskets

Fitment	Qty	Cork, Hi Density 5/16" Thick Street/Strip	Laminated Silicone Cork 1/8" Thick Racing/Hi Vacuum	Laminated Silicone Cork 1/4" Thick Racing/Hi Vacuum	Molded Silicone Rubber Street Performance	Steel Core Teflon® Coated .078" Thick Severe Duty
<i>5 bolt 2 over 3 perimeter pattern</i>						
1970-91 318-360ci & all race heads thru W9	1pr		269175	269176	269177	269178
	Dyno Pak		69175-10	69176-10		69178-10
<i>10 bolt 5 over 5 perimeter pattern</i>						
1991 & later 5.2L - 5.9L Magnum	1pr		269171	269172		269179
	Dyno Pak		69171-10	69172-10		69179-10

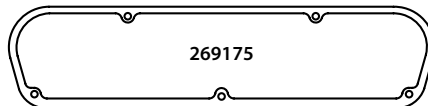

Intake Gaskets

Fitment & Dimensions	Thickness	Accu Seal E Standard Material		Accu Seal Pro Premium Materials	
		Packaged 1 Pair	Dyno Pak	Packaged 1 Pair	Dyno Pak
273-318ci 2 Barrel 1.050" x 2.187"	.062"	169101	69101-10	269101	269101-10
	.125"	169106			Silicone Bead Sealed Ports
<i>Fits stock iron heads from 1964 to 1990</i>					
318-360ci 4 Barrel & Magnum 1.175" x 2.275"	.062"	169104	69104-10	269104	269104-10
	.125"	169107			Silicone Bead Sealed Ports
<i>Fits 4 barrel heads from 1970 & later</i>					
360 Magnum Ported 2.250" x 2.400"	.062"	169112	69112-10	269112	269112-10
<i>Also fits Indy CNC Oval Port</i>					
W2 Oval Port 1.415" x 2.300"	.062"	169102	69102-10	269102	269102-10
	.125"	169103			Silicone Bead Sealed Ports
<i>Fits Indy 360-1 as delivered with CNC ports by Indy</i>					
Indy 360-1 1.360" x 2.160"	.062"	169111	69111-10	269111	269111-10
<i>Fits Indy 360-1 CNC ported to 245cc</i>					
Indy 360-1 Large Port 1.440" x 2.230"	.062"	169110	69110-10	269110	269110-10
<i>Fits Mopar W7 & W8 heads</i>					
W7 - W8 Race Heads 1.400" x 2.150"	.062"	169105	69105-10	269105	269105-10
	.125"	169108			
<i>Gasket includes water and intake ports as cast in W9RP semi-finished head</i>					
W9 Raised Port trim to fit	.062"	169109	69109-10	269109	269109-10

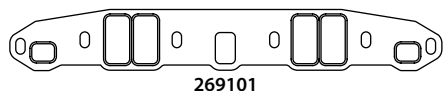

269101

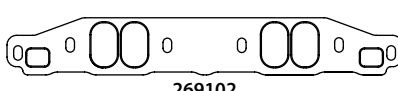

269102

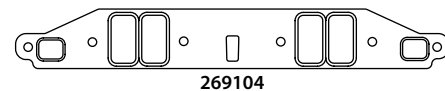

269104

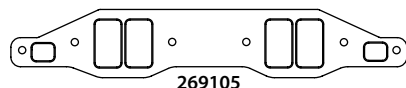

269105

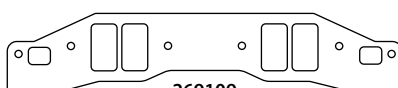

269109

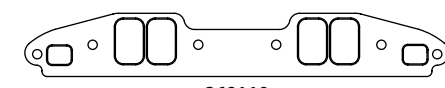

269110

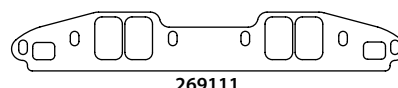

269111

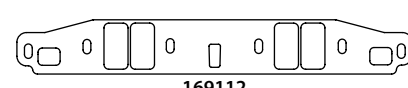

169112

Exhaust Gaskets

Fitment & Dimensions	Accu Seal E Standard Material	E Dyno Pak Bulk Pak of 10 pr	Accu Seal Pro Premium Material	Pro Dyno Pak Bulk Pak of 10 pr	Pro Copper Embossed Raised Sealing Bead	Pro Copper Annealed Flat, Soft .062" Thick
318-360ci 4 Barrel 1.100" x 1.700"	169081	69081-10	269181	69181-10	4069	E69186 supersedes 069186
<i>Stock bolt pattern, lower port corners have prominent angle</i>						
1992 & Later 5.2L - 5.9L Magnum 1.200" x 1.520"	169083	69083-10	269183	69183-10	4169	
<i>Stock bolt pattern, Lower port corners have slight angle</i>						
W2 Stock Port 1.500" x 1.460" D' Port	169085	69085-10	269185	69185-10		
<i>Fits as delivered W2 port, gasket has dual bolt patterns for both stock and W2</i>						
W2 Race Head 1.880" Round	169084	69084-10	269184	69184-10		
<i>Fits W2 ported race head & seals up to 2" headers</i>						
W7/W8/W9 Race Heads 1.800" x 1.750" Oval	169082	69082-10	269182	69182-10		
<i>7 bolts, three sections to allow for injectors, fits ported heads and seals up to 2" headers</i>						

See fitment instructions on page 358



4069



4169

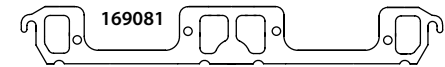

169081



169082

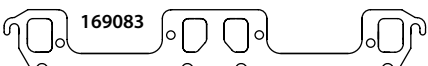

169083



169084

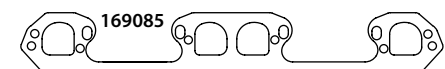

169085

Head Gaskets

Performance Composite/Steel Head Gasket for Chrysler Small Block

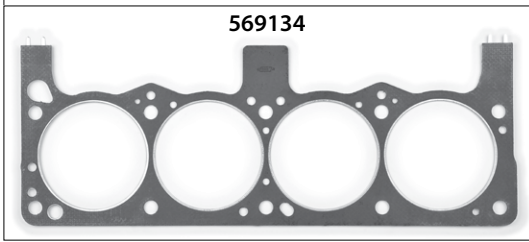

- Fits 318-360ci 'LA' series engines from 1970 through 1991.
- Bore opening 4.130" Compressed thickness: .041"
- Packaged individually.

Performance Composite Head Gasket for Chrysler Magnum

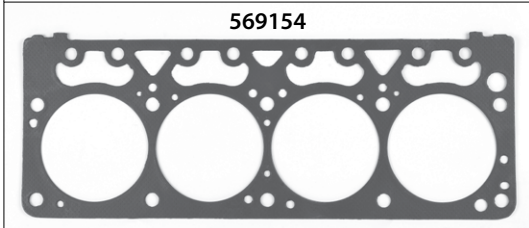

- Fits Chrysler 5.2L - 5.9L Magnum engines 1992 & later.
- Bore opening: 4.150" Compressed Thickness: .041"
- Packaged individually.

Copper Racing Head Gaskets for Chrysler Small Block

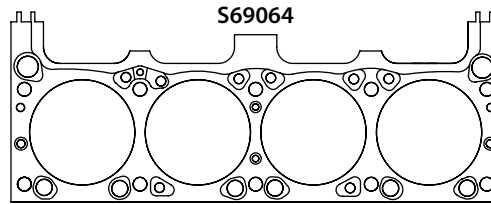
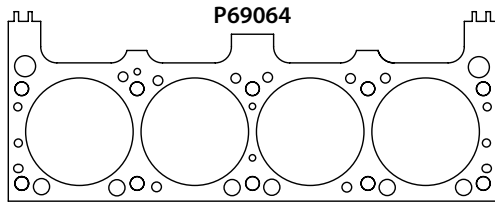

Gasket Style	Bore	Thickness							
		.021"	.032"	.043"	.050"	.062"	.072"	.080"	.093"
Pro Copper for use with o-rings & sealant	4.060" round	P69062	P69063	P69064	P69065	P69066	P69067	P69068	P69069
Titan sealed coolant passages, for use with o-rings			T69063	T69064	T69065	T69066	T69067	T69068	T69069
ICS Titan sealed coolant passages, integral combustion o-ring				S69064	S69065	S69066	S69067	S69068	S69069
Pro Copper for use with o-rings & sealant	4.160" round	P69152	P69153	P69154	P69155	P69156	P69157	P69158	P69159
Titan sealed coolant passages, for use with o-rings			T69153	T69154	T69155	T69156	T69157	T69158	T69159
ICS Titan sealed coolant passages, integral combustion o-ring				S69154	S69155	S69156	S69157	S69158	S69159
Pro Copper for use with o-rings & sealant	4.200" round	P69202	P69203	P69204	P69205	P69206	P69207	P69208	P69209
Titan sealed coolant passages, for use with o-rings			T69203	T69204	T69205	T69206	T69207	T69208	T69209
ICS Titan sealed coolant passages, integral combustion o-ring				S69204	S69205	S69206	S69207	S69208	S69209

"P" prefix supersedes "O" prefix • Packaged in Pairs. • Pro Copper available without water holes: Use Suffix "NW"

Copper Racing Head Gaskets for Mopar R1, R3, R4 & 'A' Aluminum Blocks with 6 bolt pattern

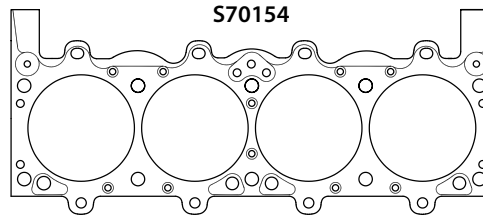
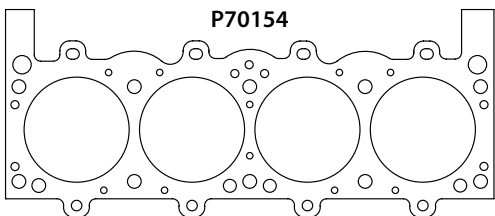

Gasket Style	Bore	Thickness							
		.021"	.032"	.043"	.050"	.062"	.072"	.080"	.093"
Pro Copper for use with o-rings & sealant	4.060" round	P70062	P70063	P70064	P70065	P70066	P70067	P70068	P70069
Titan sealed coolant passages, for use with o-rings			T70063	T70064	T70065	T70066	T70067	T70068	T70069
ICS Titan sealed coolant passages, integral combustion o-ring				S70064	S70065	S70066	S70067	S70068	S70069
Pro Copper for use with o-rings & sealant	4.160" round	P70152	P70153	P70154	P70155	P70156	P70157	P70158	P70159
Titan sealed coolant passages, for use with o-rings			T70153	T70154	T70155	T70156	T70157	T70158	T70159
ICS Titan sealed coolant passages, integral combustion o-ring				S70154	S70155	S70156	S70157	S70158	S70159
Pro Copper for use with o-rings & sealant	4.200" round	P70202	P70203	P70204	P70205	P70206	P70207	P70208	P70209
Titan sealed coolant passages, for use with o-rings			T70203	T70204	T70205	T70206	T70207	T70208	T70209
ICS Titan sealed coolant passages, integral combustion o-ring				S70204	S70205	S70206	S70207	S70208	S70209

"P" prefix supersedes "O" prefix • Packaged in Pairs. • Pro Copper available without water holes: Use Suffix "NW"

Head Gaskets

Copper Racing Head Gaskets for Mopar R5/P7 with 6 bolt pattern

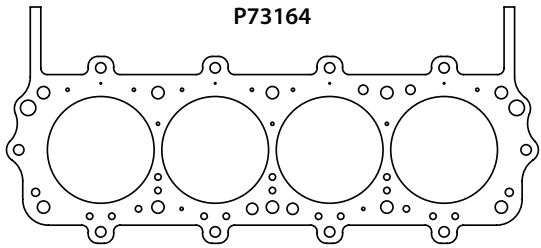

Gasket Style	Bore	Thickness							
		.021"	.032"	.043"	.050"	.062"	.072"	.080"	.093"
Pro Copper for use with o-rings & sealant	4.160" round	P73162	P73163	P73164	P73165	P73166	P73167	P73168	P73169
Pro Copper for use with o-rings & sealant	4.200" round	P73202	P77203	P73204	P73205	P73206	P73207	P73208	P73209
Pro Copper for use with o-rings & sealant	4.250" round	P73252	P73253	P77254	P73255	P73256	P73257	P73258	P73259

"P" prefix supersedes "0" prefix • Pro Copper available without water holes: Use Suffix "NW" • Packaged in Pairs.

CHRYSLER BIG BLOCK

Short Block Gaskets & Seals

Application	Qty	Oil Pan Gasket	Front Cover Gaskets TC, WP, FP	Water Pump	Timing Cover Seal	Timing Cover Set	Rear Main Seal	Fuel Pump/Oil Pump	Water Outlet	
Accu-Seal E standard gasket materials, nitrile or silicone seals.										
354-392ci Early Hemi	Each	167090	16700	16701	16702	16703	16904 354 only	16706	16708	
	Dyno pak	67090-10	6700-10	6701-10	6702-10		6904-10	6706-10	6708-10	
	Accu-Seal Pro premium gasket materials, Fluoroelastomer (Viton®) seals, molded water outlet.									
	Each	267090			26702					
Dyno Pak	267090-10			26702-10						
Accu-Seal Pro premium gasket materials, Fluoroelastomer (Viton®) seals, molded water outlet.										
Rodeck/Emery Billet 392	Each	267092 NHRA legal steel core with Red Teflon®			26702		13405			
	Dyno Pak	267092-10			26702-10		3405-10			
	Accu-Seal E standard gasket materials, nitrile or silicone seals.									
	Each	167091	16700		16702		13405			
Dyno pak	67091-10	6700-10		6702-10		3405-10				
Accu-Seal Pro premium gasket materials, Fluoroelastomer (Viton®) seals, molded water outlet.										
Donovan 417	Each	267091 NHRA legal steel core with Red Teflon®			26702					
	Dyno pak	269091-10			26702-10					
	Accu-Seal E standard gasket materials, nitrile or silicone seals.									
	Each	164090	16400	16401	16402	16403	16605	16406	16408	
Dyno pak	64090-10	6400-10	6401-10	6402-10		6605-10	6406-10	6408-10		
Accu-Seal Pro premium gasket materials, Fluoroelastomer (Viton®) seals, molded water outlet.										
383-440ci 'RB' & 426 Hemi	Each	264090 NHRA legal steel core with Red Teflon®			26602		26605			
	Dyno pak	264090-10			26602-10		26605-10			
	Accu-Seal Pro premium gasket materials, Fluoroelastomer (Viton®) seals, molded water outlet.									
	Each	264092 Molded silicone rubber over steel			26602		26605			

Continued on page 38 ►

Short Block Gaskets & Seals continued

AJPE/BAE Racing Hemi	Each	166090	16600	16602	26605	Viton® fits Chrysler 2.750" diameter main journal	
	Dyno pak	66090-10	6600-10	6602-10	26605-10		
	Accu-Seal E standard gasket materials, nitrile or silicone seals.						
	Accu-Seal Pro premium gasket materials, Fluoroelastomer (Viton®) seals, molded water outlet.						
- Oil pan gasket has no cutout for dipstick/ oil pickup -	Each	266091			23505	Viton® fits Ford 3.00" diameter main journal	
	Dyno pak	266091-10			23505-10		
TFX Racing Hemi -early wide pan-	Each	161091					
	Dyno pak	61091-10					
	Accu-Seal E standard gasket materials, nitrile or silicone seals.						
	Accu-Seal Pro premium gasket materials, Fluoroelastomer (Viton®) seals, molded water outlet.						
	Each	261091			26605		
	Dyno pak	261091-10			26605-10		
TFX Racing Hemi	Each	161092					
	Dyno pak	61092-10					
	Accu-Seal E standard gasket materials, nitrile or silicone seals.						
	Accu-Seal Pro premium gasket materials, Fluoroelastomer (Viton®) seals, molded water outlet.						
	Each	261092			26605		
	Dyno pak	261092-10			26605-10		
CN Billet Blocks Wide Rail Hemi	Each	161096					
	Dyno pak	61096-10					
	Accu-Seal E standard gasket materials, nitrile or silicone seals.						
	Accu-Seal Pro premium gasket materials, Fluoroelastomer (Viton®) seals, molded water outlet.						
	Each	261096			26605		
	Dyno pak	261096-10			26605-10		
CN Billet Blocks 1040Y / 1041Y Racing Hemi	Accu-Seal Pro premium gasket materials, Fluoroelastomer (Viton®) seals, molded water outlet.						
	Each	261097			26605		
	Dyno pak	261097-10			26605-10		

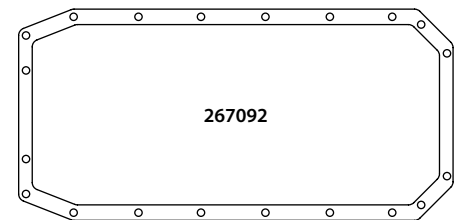
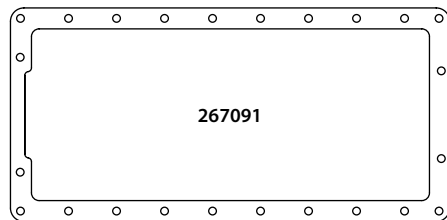
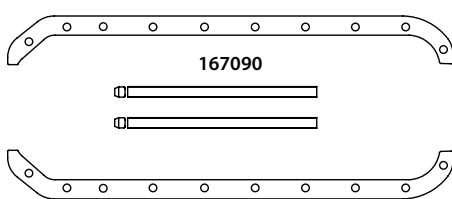
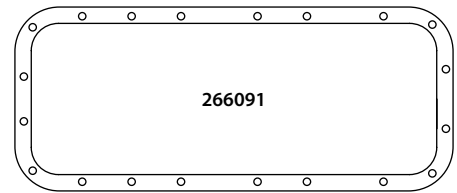
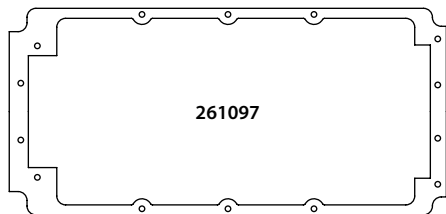
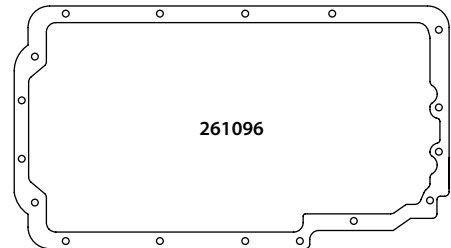
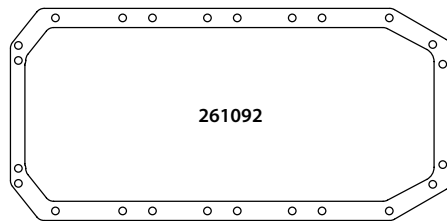
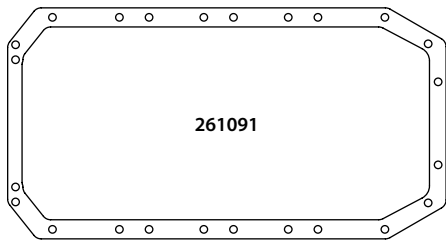

Valve Cover Gaskets

Fitment	Qty	Laminated Silicone Cork 1/8" Thick <i>Racing/Hi Vacuum</i>	Laminated Silicone Cork 1/4" Thick <i>Racing/Hi Vacuum</i>	Rubberized Fiber 3/16" Thick <i>Street Performance</i>	Fuel Resistant Fiber 1/16" Thick <i>Sportsman Racing</i>	Steel Core Red Teflon® Coated .085" Thick <i>Severe Duty</i>
<i>4 bolts, includes notches for large valve springs</i>						
354-392ci Hemi	1pr	267175	267176	167076	267075	267077
	Dyno Pak	267175-10	267176-10	67076-10	267075-10	267077-10
<i>8 bolts, fits stock iron blocks and stock pattern aftermarket blocks</i>						
354-392ci Valley Cover	1pr				167104	267104
	Dyno Pak				67104-10	267104-10
Donovan 417 Valley Cover	1pr				167106	267106
	Dyno Pak				67106-10	267106-10
<i>6 bolts 2 over 4, fits all 'RB', Indy Wedge, Brodix B1 BS, Edelbrock and similar</i>						
383-440ci 'RB'	1pr	264075	264076		264074	264078
	Dyno Pak	264075-10	264076-10		264074-10	264078-10
<i>6 bolts, fits original B1, Brodix B1 Mopar, rounded lower corners, inward curve upper corners</i>						
Mopar B1	1pr	264077	264079		264071	264072
	Dyno Pak	264077-10	264079-10		264071-10	264072-10
<i>7 bolts, 3 over 4, fits only Koffel B-1 T/S 4.840" bore center cylinder heads</i>						
Koffel B-1 T/S	1pr	265075	265076	165076	265077	265078
	Dyno Pak	265075-10	265076-10	165076-10	265077-10	265078-10
<i>10 bolts, fits only A990 426</i>						
1964-65 Chrysler A-990 426 Hemi	1pr	266275	266276	166276		
	Dyno Pak	266275-10	266276-10	66276-10		
<i>10 bolts, fits all 1966-71 426 Street Hemi and 'Gen 2' Crate Hemi</i>						
426 'Late Model' Hemi	1pr	266175	266176	166076	166075	266075
	Dyno Pak	266175-10	266176-10	66076-10	66075-10	266075-10
<i>10 bolts, same shape as street hemi with larger 5/16" bolts as mandated by NHRA</i>						
426 Fuel/Alcohol Hemi	1pr				161075	261075
	Dyno Pak				61075-10	261075-10
<i>3 over 4 bolts, also fits AJPE Musclehead</i>						
BAE Fathead	1pr				163075	263075
	Dyno Pak				163075-10	263075-10
<i>Meets NHRA breather gasket rules, 2 bolts, standard shape fits all popular breathers</i>						
Valve Cover Breather Gaskets	1pr				16604	26604
	Dyno Pak				16604-10	26604-10

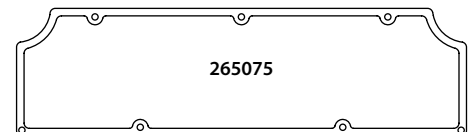
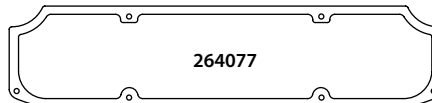
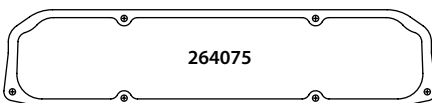
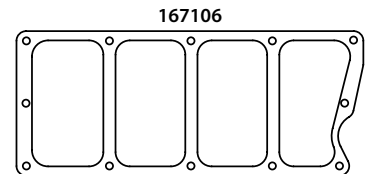
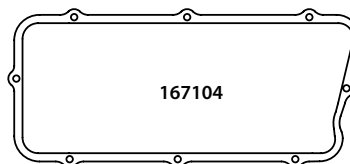
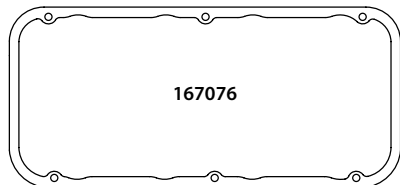
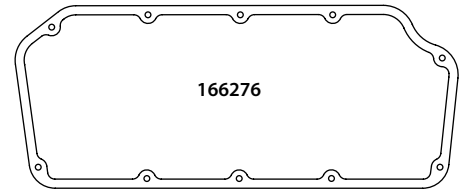
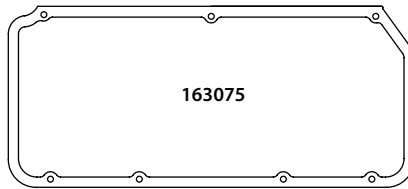
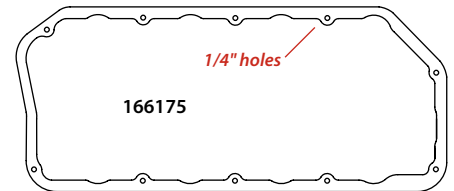
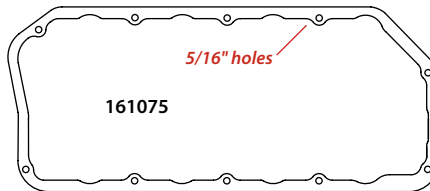
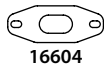

Intake Gaskets

Fitment & Dimensions	Thickness	Accu Seal E Standard Material		Accu Seal Pro Premium Materials	
		Packaged 1 Pair	Dyno Pak	Packaged 1 Pair	Dyno Pak
<i>Manifold gaskets only, fits most aftermarket head / manifold combinations</i>					
354-392 Stock Iron Heads 1.500" x 2.050"	.062"	167101	67103-10	267101	267103-10
	.125"	167106			
<i>Fits only AJPE billet Nostalgia Fuel heads</i>					
AJPE Billet 392 1.600" x 2.250"	.062"	167103	67103-10	267103	267103-10
<i>Also fits Brodix B1 BS, Indy Wedge, Edelbrock Performer & similar. Manifold gaskets only</i>					
383-440 'RB' Wedge	.062"	164101	64101-10	264101	264101-10
<i>Silicone Bead Sealed Ports</i>					
440 Max Wedge 1.375" x 2.675"	.062"	164102	64102-10	264102	264102-10
<i>Also fits Indy 440, Edelbrock Max Wedge. Manifold gaskets only</i>					
Mopar B1 1.650" x 2.700"	.062"	164104	64104-10	264104	264104-10
<i>Also fits Brodix B1 Mopar. Manifold gaskets only.</i>					
426 Street Hemi 1.875" x 2.00"	.062"	166101	66101-10	266101	266101-10
<i>8 bolt stock pattern fits factory iron and aluminum heads</i>					
426 Racing Hemi 2.130" x 2.270"	.062"	166103	66103-10	266103	266103-10
<i>Fits AJPE, BAE, Stage 5, Indy Legend, KB 10 Bolt, Warhead & Fathead 3,5,6,8</i>					

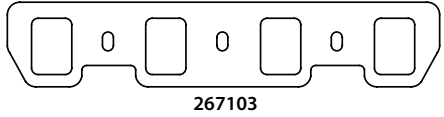
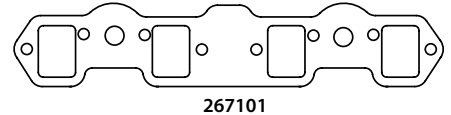
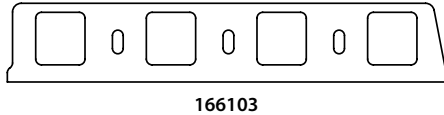
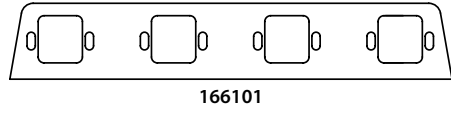
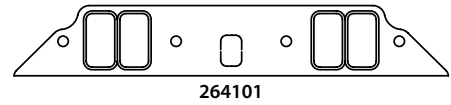
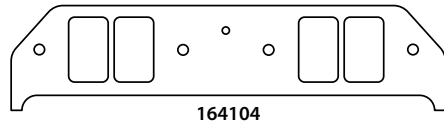
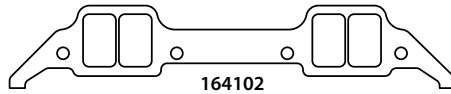

Exhaust Gaskets

Fitment & Dimensions	Accu Seal E Standard Material	E Dyno Pak Bulk Pak of 10 pr	Accu Seal Pro Premium Material	Pro Dyno Pak Bulk Pak of 10 pr	Pro Copper Embossed Raised Sealing Bead	Pro Copper Annealed Flat, Soft .062" Thick
<i>Fits stock iron manifolds and stock pattern headers</i>						
354-392ci Early Hemi 2.250" Round					4067	E67186 <i>supersedes 067186</i>
<i>Additional upper bolts between outer ports, embossed gasket matches oval exhaust port</i>						
AJPE Billet 392 Nostalgia Fuel 2.500" x 1.900" Oval	167080	167080-10	267080	267080-10	4167	E67286
<i>7 bolts, fits 413 'RB' wedge used in trucks & motorhomes from 1965-71</i>						
413ci Wedge Truck Engine 1.700" x 1.300"					4264	
<i>Standard 6 bolt pattern also fits Indy 440, Brodix B1</i>						
383-440ci Wedge 1.680" x 1.300"	164081	164081-10	264080	264080-10	4164	
<i>Large port standard 6 bolt pattern also fits Indy 572, 600 and Mopar B1</i>						
Max Wedge 1.700" x 1.500"	164080	164080-10	264080	264080-10	4064	E64186 <i>supersedes 064186</i>
426 Street Hemi/572 Crate Hemi 1.745" x 1.745"	166080	166080-10	266080	266080-10	4266	E66286 <i>supersedes 066286</i>
<i>16 bolts, fits Smiley's Headers with 2.5" round openings</i>						
Early Fuel/Alcohol Heads 2.365" Round					4466	
<i>Extra large port opening to fit Smiley's TF headers, upper bolt holes slotted for universal fit</i>						
AJPE/BAE/Dart Fuel Heads 2.525" x 2.050"					4066	
<i>Fits AJPE Stage 1 through 4 Top Fuel heads</i>						
AJPE Stage 1-4 Fuel Heads 2.300" x 1.550"					4566	
<i>Standard 10 bolt pattern for 2.5" round header opening</i>						
AJPE/Dart Alcohol Heads 2.5" Round					4366	
<i>Fits most Smiley's headers for BAE Fathead</i>						
BAE Fathead 3-4 2.560" x 2.290"					4163	
BAE Fathead 5 2.600" x 1.850"					4063	
BAE Fathead 6-8x 2.450" x 2.050" D Port					4263	
<i>Standard Veney bolt pattern fits 2 3/4" round header opening</i>						
Veney Alcohol Heads 2.750" Round					4068	
<i>Standard Veney bolt pattern fits oval port and oval header opening</i>						
Veney Alcohol Heads 2.650" x 2.300" Oval	168080	168080-10	268080	268080-10	4168	

See fitment instructions on page 358

Illustrations on page 41 ►

Exhaust Gaskets

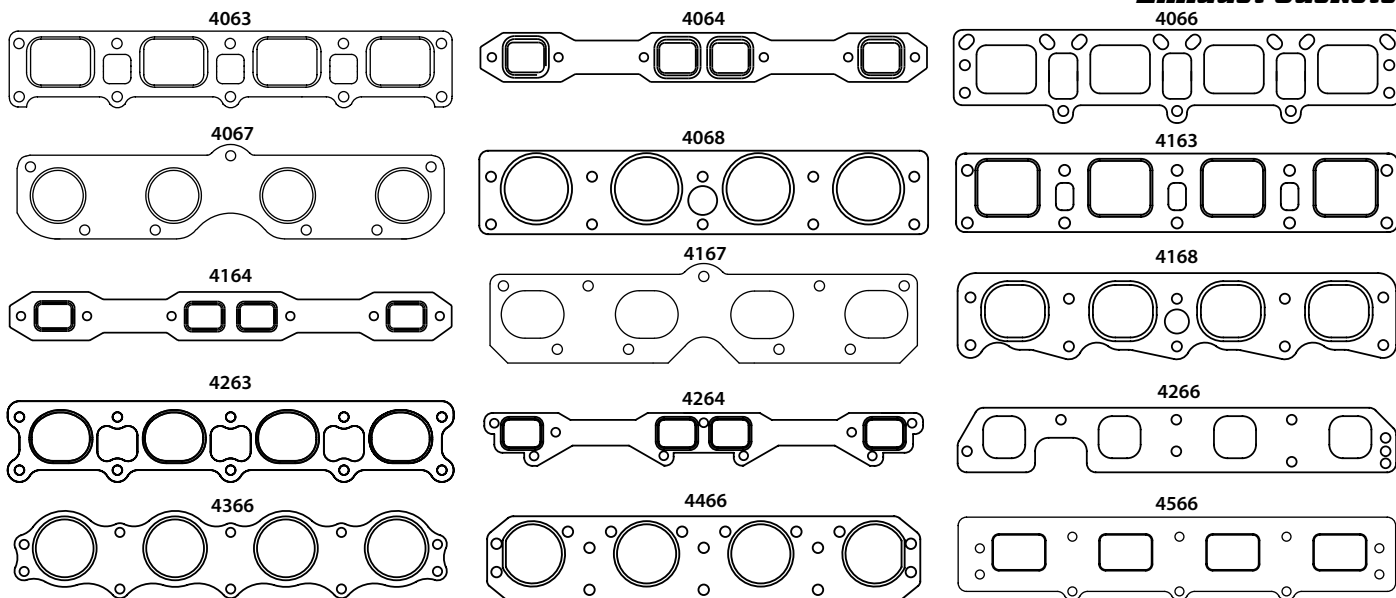

Head Gaskets

Performance Composite/Steel Head Gasket

- Fits Chrysler 383-440ci Wedge.
- Bore opening: 4.410"
- Compressed Thickness: .040"
- Packaged individually.

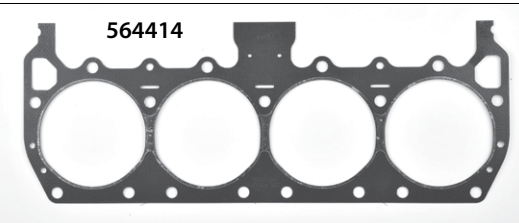

Steel Shim Head Gasket

- Fits Chrysler 383-440ci Wedge.
- Bore opening: 4.410"
- Compressed Thickness: .020"
- Packaged individually.

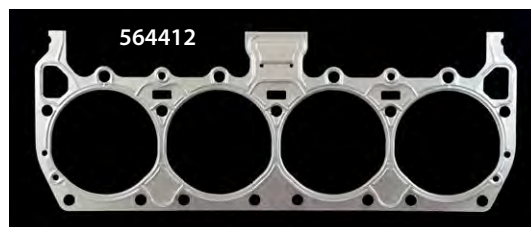

Copper Racing Head Gaskets for Chrysler Wedge

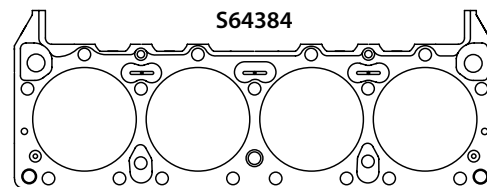
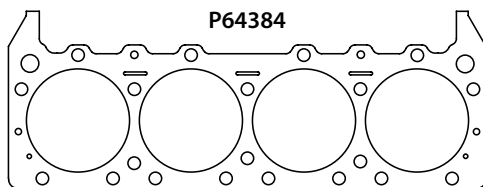

Gasket Style	Bore	Thickness							
		.021"	.032"	.043"	.050"	.062"	.072"	.080"	.093"
Pro Copper for use with o-rings & sealant	4.380" round	P64382	P64383	P64384	P64385	P64386	P64387	P64388	P64389
Titan sealed coolant passages, for use with o-rings			T64383	T64384	T64385	T64386	T64387	T64388	T64389
ICS Titan sealed coolant passages, integral combustion o-ring				S64384	S64385	S64386	S64387	S64388	S64389
Pro Copper for use with o-rings & sealant	4.440" round	P64442	P64443	P64444	P64445	P64446	P64447	P64448	P64449
Titan sealed coolant passages, for use with o-rings			T64443	T64444	T64445	T64446	T64447	T64448	T64449
ICS Titan sealed coolant passages, integral combustion o-ring				S64444	S64445	S64446	S64447	S64448	S64449
Pro Copper for use with o-rings & sealant	4.520" round	P64522	P64523	P64524	P64525	P64526	P64527	P64528	P64529
Titan sealed coolant passages, for use with o-rings			T64523	T64524	T64525	T64526	T64527	T64528	T64529
ICS Titan sealed coolant passages, integral combustion o-ring				S64524	S64525	S64526	S64527	S64528	S64529
Pro Copper for use with o-rings & sealant	4.570" round	P64572	P64573	P64574	P64575	P64576	P64577	P64578	P64579
Titan sealed coolant passages, for use with o-rings			T64573	T64574	T64575	T64576	T64577	T64578	T64579
ICS Titan sealed coolant passages, integral combustion o-ring				S64574	S64575	S64576	S64577	S64578	S64579

"P" prefix supersedes "O" prefix • Packaged in Pairs. • Pro Copper available without water holes: Use Suffix "NW"

Head Gaskets

Copper Racing Head Gaskets for 354-392 Early Hemi

S67064

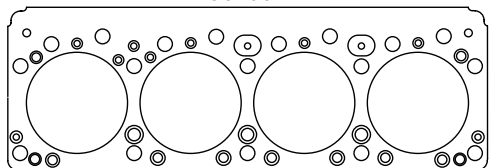

P67064AJ

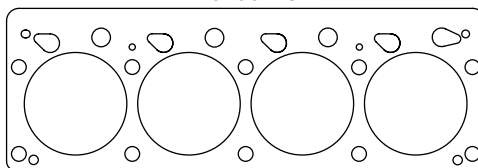

Gasket Style	Bore	Thickness							
		.021"	.032"	.043"	.050"	.062"	.072"	.080"	.093"
Pro Copper for use with o-rings & sealant	4.010" round	P67002	P67003	P67004	P67005	P67006	P67007	P67008	P67009
Titan sealed coolant passages, for use with o-rings			T67003	T67004	T67005	T67006	T67007	T67008	T67009
ICS Titan sealed coolant passages, integral combustion o-ring				S67004	S67005	S67006	S67007	S67008	S67009
Pro Copper for use with o-rings & sealant	4.060" round	P67062	P67063	P67064	P67065	P67066	P67067	P67068	P67069
Titan sealed coolant passages, for use with o-rings			T67063	T67064	T67065	T67066	T67067	T67068	T67069
ICS Titan sealed coolant passages, integral combustion o-ring				S67064	S67065	S67066	S67067	S67068	S67069
Pro Copper for use with o-rings & sealant	4.160" round	P67152	P67153	P67154	P67155	P67156	P67157	P67158	P67159
Titan sealed coolant passages, for use with o-rings			T67153	T67154	T67155	T67156	T67157	T67158	T67159
ICS Titan sealed coolant passages, integral combustion o-ring				S67154	S67155	S67156	S67157	S67158	S67159

Pro Copper available without water holes: Use Suffix "NW" • Pro Copper for AJPE Billet 392 as shown above right: Use suffix "AJ" • Packaged in Pairs.

Copper Racing Head Gaskets for Donovan 417 Big Bore

P67254

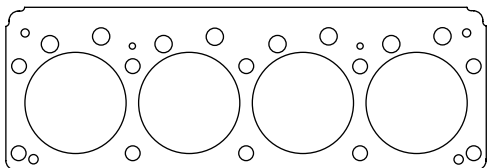

P67254R

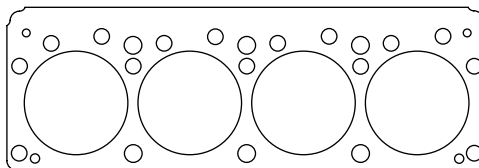

• "R" suffix: 11/16" ring dowels at 6 center bolts.

Gasket Style	Bore	Thickness							
		.043"	.050"	.062"	.072"	.080"	.093"		
Pro Copper for use with o-rings	4.250"	P67254	P67255	P67256	P67257	P67258	P67259		
Pro Copper for use with o-rings	4.320"	P67324	P67325	P67326	P67327	P67328	P67329		

"P" prefix supersedes "O" prefix • For 11/16" ring dowels on 6 center bolts use suffix "R". • Packaged in Pairs.

Copper Racing Head Gaskets for Chrysler 426 Street Hemi

T66324

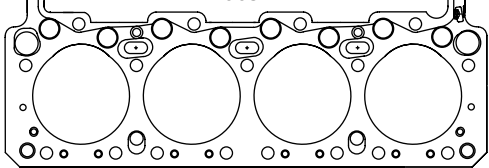

P66524

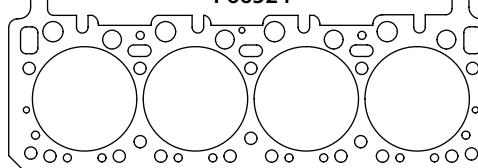

Gasket Style	Bore	Thickness							
		.021"	.032"	.043"	.050"	.062"	.072"	.080"	.093"
Pro Copper for use with o-rings & sealant	4.250" round	P66252	P66253	P66254	P66255	P66256	P66257	P66258	P66259
Titan sealed coolant passages, for use with o-rings			T66253	T66254	T66255	T66256	T66257	T66258	T66259
ICS Titan sealed coolant passages, integral combustion o-ring		No Fit, intake valve notch extends beyond 4.440"							
Pro Copper for use with o-rings & sealant	4.320" round	P66322	P66323	P66324	P66325	P66326	P66327	P66328	P66329
Titan sealed coolant passages, for use with o-rings			T66323	T66324	T66325	T66326	T66327	T66328	T66329
ICS Titan sealed coolant passages, integral combustion o-ring		No Fit, intake valve notch extends beyond 4.440"							
Pro Copper for use with o-rings & sealant	4.380" round	P66382	P66383	P66384	P66385	P66386	P66387	P66388	P66389
Titan sealed coolant passages, for use with o-rings			T66383	T66384	T66385	T66386	T66387	T66388	T66389
ICS Titan sealed coolant passages, integral combustion o-ring		No Fit, intake valve notch extends beyond 4.440"							
Pro Copper for use with o-rings & sealant	4.440" round	P66442	P66443	P66444	P66445	P66446	P66447	P66448	P66449
Titan sealed coolant passages, for use with o-rings			T66443	T66444	T66445	T66446	T66447	T66448	T66449
ICS Titan sealed coolant passages, integral combustion o-ring		No Fit, intake valve notch extends beyond 4.440"							
Pro Copper for use with o-rings & sealant	4.520" round	P66522	P66523	P66524	P66525	P66526	P66527	P66528	P66529
Titan sealed coolant passages, for use with o-rings			T66523	T66524	T66525	T66526	T66527	T66528	T66529
ICS Titan sealed coolant passages, integral combustion o-ring				S66524	S66525	S66526	S66527	S66528	S66529

"P" prefix supersedes "O" prefix • Packaged in Pairs. • Note: KB aluminum street hemi has relocated coolant holes below the cylinders, use "KB" suffix.

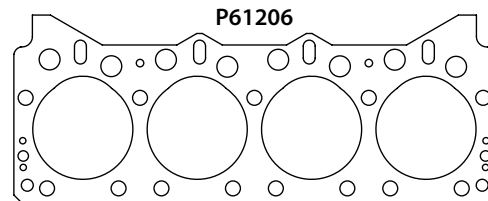
Head Gaskets
Copper Racing Head Gaskets for AJPE, BAE, Dart, TFX, KB Racing Hemi

Gasket Style	Bore	Thickness								
		.043"	.050"	.062"	.072"	.080"	.093"	.100"	.110"	
Pro Copper for use with o-rings and receiver grooves	4.200"	P61204	P61205	P61206	P61207	P61208	P61209	P61200	P61201	
Pro Copper for use with o-rings and receiver grooves	4.250"	P61254	P61255	P61256	P61257	P61258	P61259	P61250	P61251	

"P" prefix supersedes "0" prefix • Packaged in Pairs.

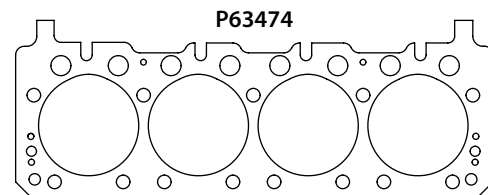
Copper Racing Head Gaskets for BAE Fathead, AJPE Musclehead

Gasket Style	Bore	Thickness								
		.043"	.050"	.062"	.072"	.080"	.093"	.100"	.110"	
Pro Copper for use with o-rings and receiver grooves	4.380"	P63384	P63385	P63386	P63387	P63388	P63389	P63380	P63381	
Pro Copper for use with o-rings and receiver grooves	4.440"	P63444	P63445	P63446	P63447	P63448	P63449	P63440	P63441	
Pro Copper for use with o-rings and receiver grooves	4.470"	P63474	P63475	P63476	P63477	P63478	P63479	P63470	P63471	

"P" prefix supersedes "0" prefix • Packaged in Pairs.

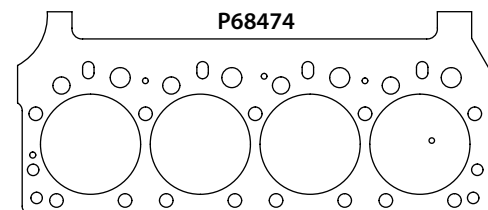
Copper Racing Head Gaskets for Veney Alcohol

Gasket Style	Bore	Thickness								
		.043"	.050"	.062"	.072"	.080"	.093"	.100"	.110"	
Pro Copper for use with o-rings and receiver grooves	4.380"	P68384	P68385	P68386	P68387	P68388	P68389	P68380	P68381	
Pro Copper for use with o-rings and receiver grooves	4.440"	P68444	P68445	P68446	P68447	P68448	P68449	P68440	P68441	
Pro Copper for use with o-rings and receiver grooves	4.470"	P68474	P68475	P68476	P68477	P68478	P68479	P68470	P68471	

"P" prefix supersedes "0" prefix • Packaged in Pairs.

Exhaust Gaskets

Fitment	Accu Seal E Standard Material	E Dyno Pak Bulk Pak of 10 pr	Accu Seal Pro Premium Material	Pro Dyno Pak Bulk Pak of 10 pr	Pro Copper Embossed Raised Sealing Bead	Pro Copper Annealed Flat, Soft .062" Thick	
Dodge Neon/ PT Cruiser 2000-05' 2.0L	Please see Engine Master Gaskets Section: Chrysler Motors: page 80					9460	
Dodge V10 Pickup Iron Heads	Please see Engine Master Gaskets Section: Chrysler Motors: page 140					4059	
Dodge SRT10 Aluminum Heads	Please see Engine Master Gaskets Section: Chrysler Motors: page 140					4159	

See fitment instructions on page 358

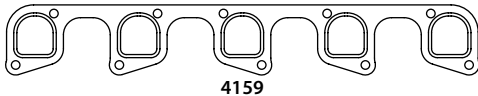
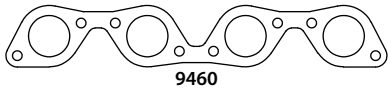

Head Gaskets

Copper Racing Head Gaskets for Other Chrysler Corp. Engines

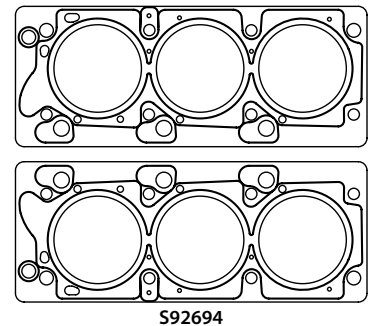
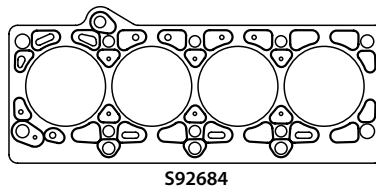
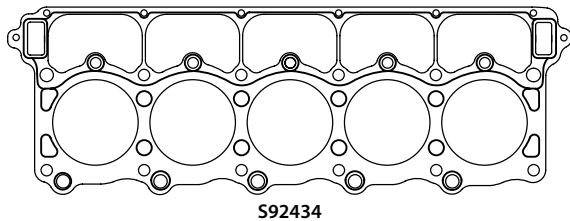

Gasket Style	Bore	Thickness							
		.021"	.032"	.043"	.050"	.062"	.072"	.080"	.093"
Dodge SRT-4 2.4L DOHC Turbo, Engine Code A855 Packaged 'each'	3.500" round	P92682	P92683	P92684	P92685	P92686	P92687	P92688	P92689
			T92683	T92684	T92685	T92686	T92687	T92688	T92689
				S92684	S92685	S92686	S92687	S92688	S92689
3.5L SOHC Prowler V-6, Engine Code EGJ Packaged in 'pairs'	3.850" round	P92692	P92693	P92694	P92695	P92696	P92697	P92698	P92699
			T92693	T92694	T92695	T92696	T92697	T92698	T92699
				S92694	S92695	S92696	S92697	S92698	S92699
2nd Generation Viper 8.0L V-10 Packaged in 'pairs'	4.060" round	P92432	P92433	P92434	P92435	P92436	P92437	P92438	P92439
			T92433	T92434	T92435	T92436	T92437	T92438	T92439
				S92434	S92435	S92436	S92437	S92438	S92439

"P" Prefix: Pro Copper for use with o-rings & sealant • "T" Prefix: Titan sealed coolant passages, for use with o-rings
 "S" Prefix: ICS Titan sealed coolant passages, integral combustion o-ring • "P" Prefix supersedes "0" Prefix

Short Block Gaskets & Seals

Application	Qty	Oil Pan Gasket	Front Cover Gaskets TC, WP, FP	Water Pump	Timing Cover Seal	Timing Cover Set	Rear Main Seal	Fuel Pump	Water Outlet
1974-93 2.3L SOHC									

Please see **Engine Master Gaskets Section**; Ford, Lincoln Mercury Cars; 4 Cyl: page 152

Exhaust Gaskets

Fitment & Dimensions	Accu Seal E Standard Material	E Dyno Pak Bulk Pak of 10 pr	Accu Seal Pro Premium Material	Pro Dyno Pak Bulk Pak of 10 pr	Pro Copper Embossed Raised Sealing Bead	Pro Copper Annealed Flat, Soft .062" Thick
2.3L SOHC SVO Turbo 1.5" Round	123080	23080-10	223080	223080-10	4023	E23186 <i>supersedes 023186</i>
2.3L Esslinger ARCA Head 1.570" x 1.700"	123081	23081-10	223081	223081-10	4123	
<i>4 individual port gaskets, rectangle port fits Esslinger ARCA Aluminum Head</i>						
2.0L DOHC Zetec 1.5" Round	123082	23082-10	223082	223082-10	9419	
2.0L DOHC Zetec R Turbo 1.700" x 1.350" Oval	123083	23083-10	223083	223083-10	9421	
2003 & Later 2.3-2.5L Duratec 1.75" Round	123084	23084-10	223084	223084-10	9440	

See fitment instructions on page 358

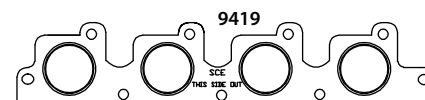
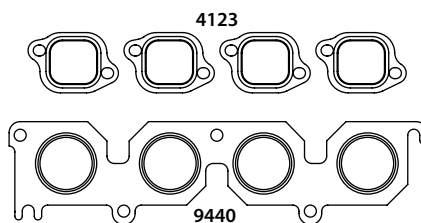
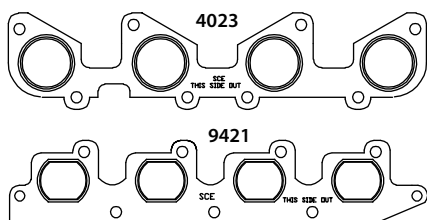
Head Gaskets
Performance Composite Head Gasket

- Fits 1974-93 2.3L SOHC "Pinto" motor.
- Bore opening : 3.875"
- Compressed Thickness: .040"

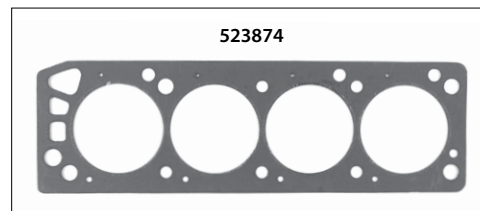
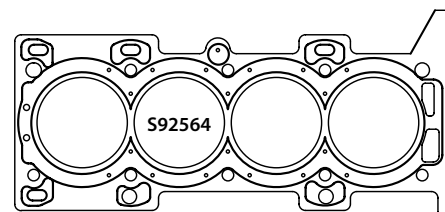
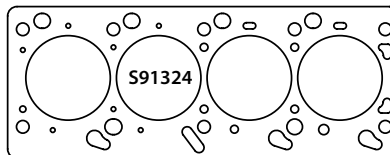
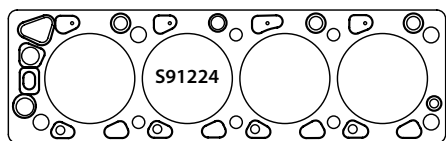

Copper Racing Head Gaskets for Ford Inline 4 Cylinder Engines

Application	Bore	Thickness							
		.021"	.032"	.043"	.050"	.062"	.072"	.080"	.093"
1974-1993 Ford 2.3L SOHC	3.850" round	P91222	P91223	P91224	P91225	P91226	P91227	P91228	P91229
			T91223	T91224	T91225	T91226	T91227	T91228	T91229
				S91224	S91225	S91226	S91227	S91228	S91229
	3.950" round	P23952	P23953	P23954	P23955	P23956	P23957	P23958	P23959
			T23953	T23954	T23955	T23956	T23957	T23958	T23959
				S23954	S23955	S23956	S23957	S23958	S23959
4.010" round	P23012	P23013	P23014	P23015	P23016	P23017	P23018	P23019	
		T23013	T23014	T23015	T23016	T23017	T23018	T23019	
	<i>No Fit; insufficient clearance for ICS Seals at this bore opening</i>								
1992-2004 Zetec / Zetec R 2.0L DOHC	3.850" round	P91322	P91323	P91324	P91325	P91326	P91327	P91328	P91329
			T91323	T91324	T91325	T91326	T91327	T91328	T91329
				S91324	S91325	S91326	S91327	S91328	S91329
2001 & Later Ford/Mazda Duratec 2.3L DOHC	3.500" round	P92562	P92563	P92564	P92565	P92566	P92567	P92568	P92569
			T92563	T92564	T92565	T92566	T92567	T92568	T92569
				S92564	S92565	S92566	S92567	S92568	S92569

"P" Prefix: Pro Copper for use with o-rings & sealant • "T" Prefix: Titan sealed coolant passages, for use with o-rings
 "S" Prefix: ICS Titan sealed coolant passages, integral combustion o-ring • "P" Prefix supersedes "0" Prefix

Short Block Gaskets & Seals

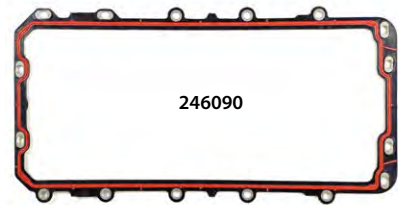
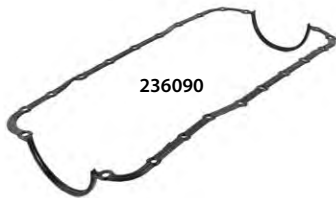
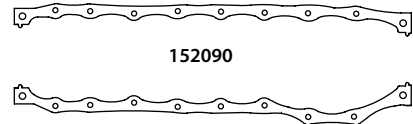
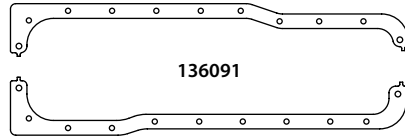
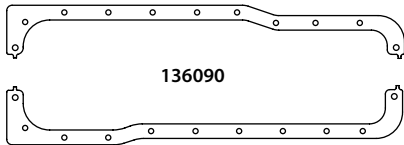
Application	Qty	Oil Pan Gasket	Front Cover Gaskets TC, WP, FP	Water Pump	Timing Cover Seal	Timing Cover Set	Rear Main Seal	Fuel Pump	Water Outlet
1962-82 260-302ci 'Windsor' engine including Boss 302	Accu-Seal E standard gasket materials, nitrile or silicone seals.								
	Each	136090	13600	13601	13602	13603	13604	13606	13608
	Dyno Pak	36090-10	3600-10	3601-10	3602-10		3604-10	3606-10	3608-10
	Accu-Seal Pro premium gasket materials, Fluoroelastomer (Viton®) seals, molded water outlet.								
	Each	236090 1 pc molded silicone			23602		23614 2 pc split seal		
Dyno Pak	236090-10			23602-10		23614-10			
1983-95 5.0L 'Windsor'	Accu-Seal E standard gasket materials, nitrile or silicone seals.								
	Each	136090	13600	13601	13602	13603	13604	13606	13608
	Dyno Pak	36090-10	3600-10	3601-10	3602-10		3604-10	3606-10	3608-10
	Accu-Seal Pro premium gasket materials, Fluoroelastomer (Viton®) seals, molded water outlet.								
	Each	236090 1 pc molded silicone			23602		23604 1 pc radial seal		
Dyno Pak	236090-10			23602-10		23604-10			
1969-83 351W 'Windsor'	Accu-Seal E standard gasket materials, nitrile or silicone seals.								
	Each	136091	13600	13601	13602	13603	13605	13606	13608
	Dyno pak	36091-10	3600-10	3601-10	3602-10		3605-10	3606-10	3608-10
	Accu-Seal Pro premium gasket materials, Fluoroelastomer (Viton®) seals, molded water outlet.								
	Each	236091 1 pc molded silicone			23602		23615 2 pc split seal		
Dyno pak	236091-10			23602-10		23615-10			
1983-97 351W 'Windsor'	Accu-Seal E standard gasket materials, nitrile or silicone seals.								
	Each	136091	13600	13601	13602	13603		13606	13608
	Dyno pak	36091-10	3600-10	3601-10	3602-10			3606-10	3608-10
	Accu-Seal Pro premium gasket materials, Fluoroelastomer (Viton®) seals, molded water outlet.								
	Each	236091 1 pc molded silicone			23602		23605 1 pc radial seal		
Dyno pak	236091-10			23602-10		23605-10			
1970-82 351C 'Cleveland' & 351-400M 'Modified'	Accu-Seal E standard gasket materials, nitrile or silicone seals.								
	Each	152090	15200	15201	13602	15203	13605	15206	15208
	Dyno pak	52090-10	5200-10	5201-10	3602-10		3605-10	5206-10	5208-10
	Accu-Seal Pro premium gasket materials, Fluoroelastomer (Viton®) seals, molded water outlet.								
	Each				23602		23615 2 pc split seal		
Dyno pak				23602-10		23615-10			
1996 & later 4.6-5.4L Modular	Accu-Seal Pro premium gasket materials, Fluoroelastomer (Viton®) seals, molded water outlet.								
	Each	246090 1pc OEM style			24602	24603	23604 1 pc radial seal		24608
	Dyno pak	246090-10			24602-10				



Valve Cover Gaskets

Fitment	Qty	Cork, Hi Density 5/16" Thick Street/Strip	Laminated Silicone Cork 1/8" Thick Racing/Hi Vacuum	Laminated Silicone Cork 1/4" Thick Racing/Hi Vacuum	Molded Silicone Rubber Street Performance	Steel Core Teflon® Coated .078" Thick Severe Duty
1962-97 260-351W all	6 bolts 3 over 3, fits all 'Windsor' style valve covers					
	1pr	136076	236175	236176	236179	236178
	Dyno Pak	36076-10	236175-10	236176-10		236178-10
1970-85 351C, 351M, 400M	8 bolts 4 over 4, also fits Boss 302, SVO Yates & Blue Thunder 351C heads					
	1pr	152076	252175	252176		252178
	Dyno Pak	52076-10	252175-10	252176-10		252178-10

Illustrations continued on page 47 ▶

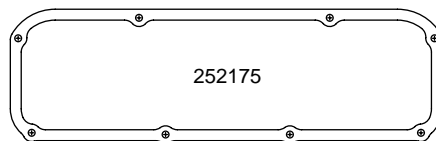
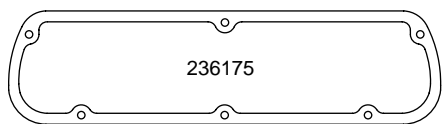
Valve Cover Gaskets continued

Intake Gaskets

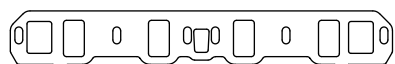
Fitment & Dimensions	Thickness	Accu Seal E Standard Material		Accu Seal Pro Premium Materials	
		Packaged 1 Pair	Dyno Pak	Packaged 1 Pair	Dyno Pak
<i>Also fits World Products Windsor and Windsor Aluminum</i>					
289-351W Small Race Port 1.070" x 2.00"	.062"	136101	36101-10	236101	236101-10
	.125"	136106	36106-10	<i>Silicone Bead Sealed Ports</i>	
<i>Gaskets have allowance for injectors at top of ports, optional heat transfer</i>					
5.0L w/Fuel Injection 1.080" x 2.060"	.062"	136110	36110-10	236110	236110-10
	.125"	136113	36113-10	<i>Silicone Bead Sealed Ports</i>	
<i>Also fits Motorsport N351 Sportsman, Edelbrock Victor Jr. TFS Twisted Wedge & Brodix T1F</i>					
Ford Motorsport GT-40 1.300" x 2.140"	.062"	136102	36102-10	236102	236102-10
Boss 302 1.900" x 2.660"	.062"	136114	36114-10	236114	236114-10
Trick Flow 'R' Series 1.370" x 2.300"	.062"	136108	36108-10	236108	236108-10
<i>Fits 18° & 15° Heads</i>					
Edelbrock Victor XL Port 1.500" x 2.240"	.062"	136103	36103-10	236103	236103-10
				<i>Silicone Bead Sealed Ports</i>	
<i>Inline oval ports</i>					
1986-95 5.0L EFI Upper to Lower Manifold	.062"	136104	36104-10	236104	236104-10
<i>Staggered round ports</i>					
GT-40 EFI Upper to Lower Manifold	.062"	136105	36105-10	236105	236105-10
351C 2 Barrel 1.515" x 2.140"	.062"	152101	52101-10	252101	252101-10
351C 2 Barrel 1.600" x 2.270"	.062"	152102	52102-10	252102	252102-10
	.125"	152106	52106-10		
351C 4 Barrel 1.900" x 2.660"	.062"	152103	52103-10	252103	252103-10
	.125"	152104	52104-10	<i>Silicone Bead Sealed Ports</i>	
<i>Circle Track Ports</i>					
SVO Yates C3 1.475" x 2.310"	.062"	152107	52107-10	252107	252107-10
	.125"	152117	52117-10		
<i>Drag Race Ports</i>					
SVO Yates C3 Large Port 1.850" x 2.225"	.062"	152105	52105-10	252105	252105-10
	.125"	152109	52109-10		
<i>Fits finished heads as delivered from Blue Thunder</i>					
Blue Thunder 351C 1.600" x 2.100"	.062"	152108	52108-10	252108	252108-10
<i>Fits "as cast ports"</i>					
Blue Thunder 18 Bolt Trim to Fit	.062"	145101	45101-10	245101	245101-10

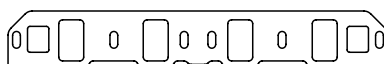

136101



136102



136103



136104



136105

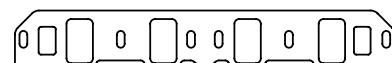

136108

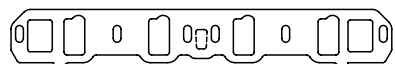

136110



136114

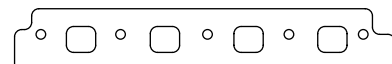

145101



152101

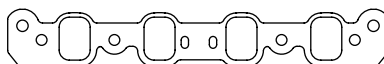

152102

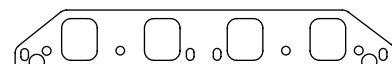

152105

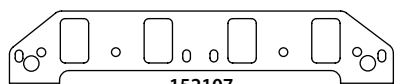

152107

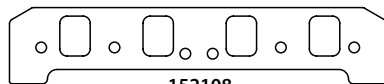

152108



252103

Exhaust Gaskets

Fitment & Dimensions	Accu Seal E <i>Standard Material</i>	E Dyno Pak <i>Bulk Pak of 10 pr</i>	Accu Seal Pro <i>Premium Material</i>	Pro Dyno Pak <i>Bulk Pak of 10 pr</i>	Pro Copper Embossed <i>Raised Sealing Bead</i>	Pro Copper Annealed <i>Flat, Soft .062" Thick</i>
289-351W Rectangle Port 1.200" x 1.470"	136081	36081-10	236181	36181-10	4036	E36186 <i>supersedes 036186</i>
<i>Fits rectangle port headers with standard 2" bolt spread</i>						
289-351W Oval Port 1.075" x 1.785"	136083	36083-10	236183	36183-10	4936	
<i>Fits Flowtech, Hedman and similar oval port headers with standard bolt pattern</i>						
SVO N351 Sportsman 1.600" x 1.775"	136082	36082-10	236182	36182-10	4236	
<i>Also fits Brodix T1F, bolt spread 2.770" across ports</i>						
Trick Flow 'R' Series 1.765" Round					4436	
<i>Dual bolt pattern matches TFS 'R' heads, also fits Motorsport 'N' heads, seals 1 7/8" primary tube headers</i>						
Trick Flow 'R' Series 1.875" Round	136084	36084-10	236184	36184-10	4836	
<i>Angled bolt pattern, seals 2" primary tube headers</i>						
Edelbrock Victor 7219 1.750" x 1.600"	136085	36085-10	236185	36185-10	4636	
<i>Fits rectangle port headers, bolt spread 2.5" across ports</i>						
Windsor Wide Pattern 1.600" x 1.775"	136086	36086-10	236186	36186-10	4736	
<i>Fits World, Dart Windsor, AFR 225 with 3" bolt spread across ports</i>						
Square Port Dual Bolt 1.310" x 1.530"	136088	36088-10	236188	36188-10		
<i>Fits Dart, TFS, E351, includes both stock location bolt pattern and inline spread pattern</i>						
J302 / K302 AR Heads 1.200" x 1.470"					4536	
<i>Dual bolt pattern also fits Hooker adapter plate</i>						
4.6 / 5.4L Modular SOHC 2 Valve 1.5" Round	146080	46080-10	246180	46180-10	4046	
<i>Fits stock manifolds and 1 5/8" primary tube headers for 1991 & later SOHC 2v engines</i>						
4.6 / 5.4L Modular DOHC 4 Valve 2.125" x 1.250" Oval	146081	46081-10	246181	46181-10	4146	
<i>Fits BBK 1532, 1533 and similar oval port headers for 4v heads</i>						
4.6 / 5.4L Modular SOHC 3 Valve 1.5" Round	146082	46082-10	246182	46182-10	4246	
<i>Fits 2002 & later</i>						
351C / 351M / 400M 2 Barrel 1.350" x 1.875" Oval	152082	52082-10	252182	52182-10	4052	
<i>Fits stock 2 barrel oval port heads</i>						
351C / 351M / 400M Large Oval 1.375" x 1.875" Oval					4252	
<i>2 barrel oval enlarged for ported heads</i>						
351C 4 Barrel / Boss 302 1.790" x 2.055"	152080	52080-10	252180	52180-10	4352	
<i>Notch top rectangle, also fits CHI 3 Valve heads</i>						
SVO C302 / B351 1.750" Round	152083	52083-10	252183	52183-10	4152	
SVO Yates C3 2.00" x 1.750"	152081	52081-10	252181	52181-10		
Blue Thunder 18 Bolt 1.730" x 1.580"	145080	45080-10	245180	45180-10	4045	

See fitment instructions on page 358

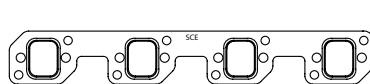
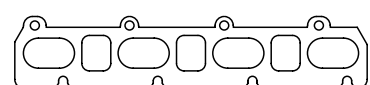
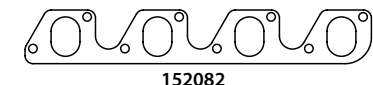
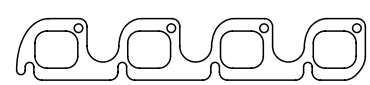
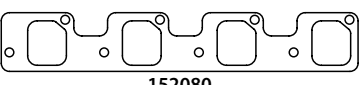
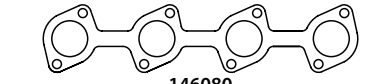
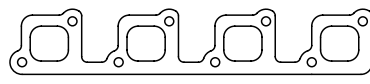
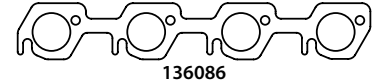
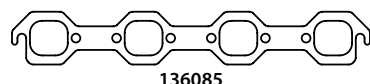
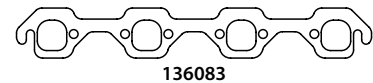
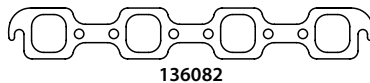
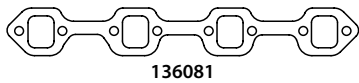

Head Gaskets
Performance Composite Head Gasket

- Fits 1964 & later Ford 260-351W engines.
- Bore opening 4.080"
- Compressed thickness: .040"
- Packaged individually.

Extra Thickness Performance Composite Head Gasket

- Fits 1964 & later Ford 260-351W engines.
- Bore opening 4.080"
- Compressed thickness: .060"
- Packaged individually.

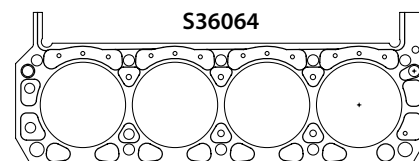
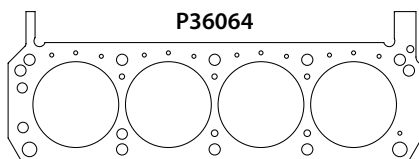
Copper Racing Head Gaskets for Ford "Windsor"

Gasket Style	Bore	Thickness							
		.021"	.032"	.043"	.050"	.062"	.072"	.080"	.093"
Pro Copper for use with o-rings & sealant	4.010" round	P36002	P36003	P36004	P36005	P36006	P36007	P36008	P36009
Titan sealed coolant passages, for use with o-rings			T36003	T36004	T36005	T36006	T36007	T36008	T36009
ICS Titan sealed coolant passages, integral combustion o-ring				S36004	S36005	S36006	S36007	S36008	S36009
Pro Copper for use with o-rings & sealant	4.060" round	P36062	P36063	P36064	P36065	P36066	P36067	P36068	P36069
Titan sealed coolant passages, for use with o-rings			T36063	T36064	T36065	T36066	T36067	T36068	T36069
ICS Titan sealed coolant passages, integral combustion o-ring				S36064	S36065	S36066	S36067	S36068	S36069
Pro Copper for use with o-rings & sealant	4.160" round	P36152	P36153	P36154	P36155	P36156	P36157	P36158	P36159
Titan sealed coolant passages, for use with o-rings			T36153	T36154	T36155	T36156	T36157	T36158	T36159
ICS Titan sealed coolant passages, integral combustion o-ring				S36154	S36155	S36156	S36157	S36158	S36159
Pro Copper for use with o-rings & sealant	4.200" round	P36202	P36203	P36204	P36205	P36206	P36207	P36208	P36209
Titan sealed coolant passages, for use with o-rings			T36203	T36204	T36205	T36206	T36207	T36208	T36209
ICS Titan sealed coolant passages, integral combustion o-ring									

No Fit: insufficient area between bores

"P" prefix supersedes "O" prefix • Packaged in Pairs. • Pro Copper available without water holes: Use Suffix "NW"

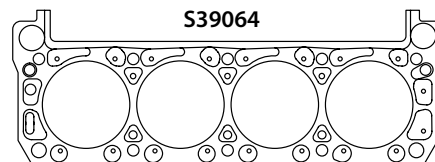
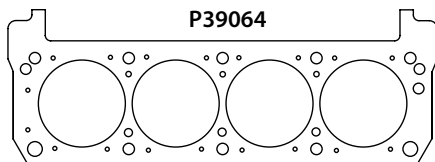
Copper Racing Head Gaskets for SVO Yates, Boss 302

Gasket Style	Bore	Thickness							
		.021"	.032"	.043"	.050"	.062"	.072"	.080"	.093"
Pro Copper for use with o-rings & sealant	4.060" round	P39062	P39063	P39064	P39065	P39066	P39067	P39068	P39069
Titan sealed coolant passages, for use with o-rings			T39063	T39064	T39065	T39066	T39067	T39068	T39069
ICS Titan sealed coolant passages, integral combustion o-ring				S39064	S39065	S39066	S39067	S39068	S39069
Pro Copper for use with o-rings & sealant	4.160" round	P39152	P39153	P39154	P39155	P39156	P39157	P39158	P39159
Titan sealed coolant passages, for use with o-rings			T39153	T39154	T39155	T39156	T39157	T39158	T39159
ICS Titan sealed coolant passages, integral combustion o-ring				S39154	S39155	S39156	S39157	S39158	S39159
Pro Copper for use with o-rings & sealant	4.200" round	P39202	P39203	P39204	P39205	P39206	P39207	P39208	P39209
Titan sealed coolant passages, for use with o-rings			T39203	T39204	T39205	T39206	T39207	T39208	T39209
ICS Titan sealed coolant passages, integral combustion o-ring									

No Fit: insufficient area between bores

Packaged in Pairs. • Pro Copper available without water holes: Use Suffix "NW" • "P" prefix supersedes "O" prefix

Head Gaskets

Ford 351C, 351M, 400M Performance Composite Head Gasket

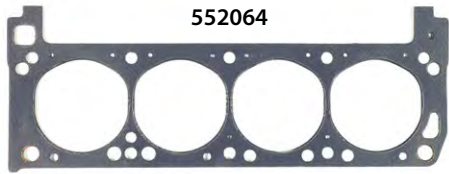

- Fits 1970-79 Ford 351C 'Cleveland' and 351-400M 'Modified' engines.
- Bore opening 4.060"
- Compressed thickness: .052"
- Packaged individually.

Copper Racing Head Gaskets for Ford 351C, 351M & 400M blocks.

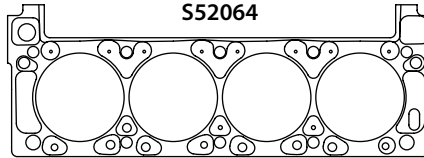
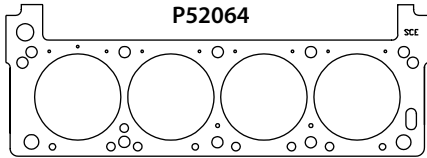

Gasket Style	Bore	Thickness							
		.021"	.032"	.043"	.050"	.062"	.072"	.080"	.093"
Pro Copper for use with o-rings & sealant	4.060" round	P52062	P52063	P52064	P52065	P52066	P52067	P52068	P52069
Titan sealed coolant passages, for use with o-rings			T52063	T52064	T52065	T52066	T52067	T52068	T52069
ICS Titan sealed coolant passages, integral combustion o-ring		No Fit: Combustion chambers extend beyond 4.060" round							
Pro Copper for use with o-rings & sealant	4.160" round	P52152	P52153	P52154	P52155	P52156	P52157	P52158	P52159
Titan sealed coolant passages, for use with o-rings			T52153	T52154	T52155	T52156	T52157	T52158	T52159
ICS Titan sealed coolant passages, integral combustion o-ring				S52154	S52155	S52156	S52157	S52158	S52159
Pro Copper for use with o-rings & sealant	4.200" round	S52154	S52154	P52204	P52205	P52206	P52207	P52208	P52209
Titan sealed coolant passages, for use with o-rings			T52203	T52204	T52205	T52206	T52207	T52208	T52209
ICS Titan sealed coolant passages, integral combustion o-ring		No Fit: Insufficient area between bores							

"P" prefix supersedes "O" prefix • Pro Copper available without water holes: Use Suffix "NW" • Packaged in Pairs.

Copper Racing Head Gaskets for Ford Modular 4.6 - 5.4L

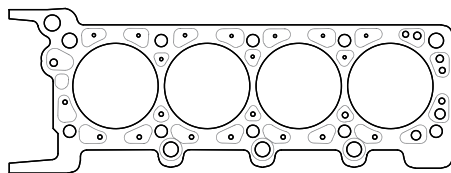

S46624
Left · Right

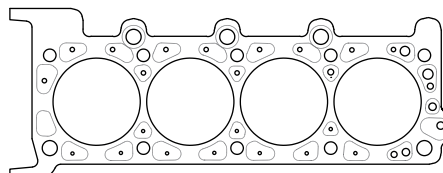

Gasket Style	Bore	Thickness							
		.021"	.032"	.043"	.050"	.062"	.072"	.080"	.093"
Pro Copper for use with o-rings & sealant	3.625" round	P46622	P46623	P46624	P46625	P46626	P46627	P46628	P46629
Titan sealed coolant passages, for use with o-rings			T46623	T46624	T46625	T46626	T46627	T46628	T46629
ICS Titan sealed coolant passages, integral combustion o-ring				S46624	S46625	S46626	S46627	S46628	S46629
Pro Copper for use with o-rings & sealant	3.750" round	P46752	P46753	P46754	P46755	P46756	P46757	P46758	P46759
Titan sealed coolant passages, for use with o-rings			T46753	T46754	T46755	T46756	T46757	T46758	T46759
ICS Titan sealed coolant passages, integral combustion o-ring				S46754	S46755	S46756	S46757	S46758	S46759

"P" prefix supersedes "O" prefix • Packaged in Pairs.

Short Block Gaskets & Seals

Application	Qty	Oil Pan Gasket	Front Cover Gaskets TC, WP, FP	Water Pump	Timing Cover Seal	Timing Cover Set	Rear Main Seal	Fuel Pump	Water Outlet	
Accu-Seal E standard gasket materials, nitrile or silicone seals.										
1961-76 352-428ci 'FE'	Each	134090	13400	13401	13402	13403	13405	13406	13408	
	Dyno Pak	34090-10	3400-10	3401-10	3402-10		3405-10	3406-10	3408-10	
Accu-Seal E standard gasket materials, nitrile or silicone seals.										
1968-98 429-460ci Big Block	Each	135090	13500	13501	13502	13503	13505	13506	13508	
	Dyno Pak	35090-10	3500-10	3501-10	3502-10		3505-10	3506-10	3508-10	
	Accu-Seal Pro premium gasket materials, Fluoroelastomer (Viton®) seals, molded water outlet.									
	Each	235091 <i>1 pc molded silicone</i>				23502		23505		
Dyno Pak	235091-10				23502-10		23505-10			

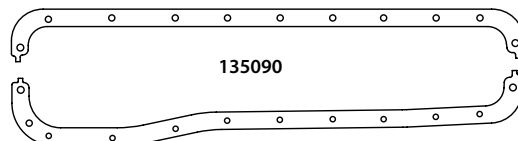
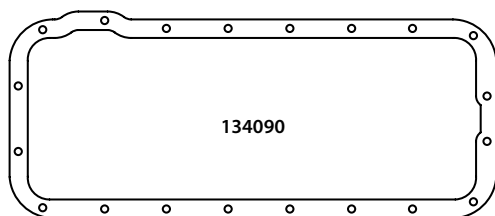

Valve Cover Gaskets

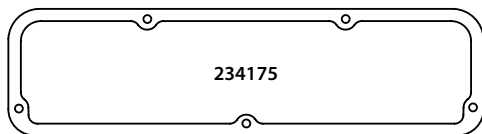
Fitment	Qty	Cork, Hi Density 5/16" Thick <i>Street/Strip</i>	Laminated Silicone Cork 1/8" Thick <i>Racing/Hi Vacuum</i>	Laminated Silicone Cork 1/4" Thick <i>Racing/Hi Vacuum</i>	Molded Silicone Rubber <i>Street Performance</i>	Steel Core Teflon® Coated .078" Thick <i>Severe Duty</i>
<i>5 Bolts, 2 over 3 fits all wedge head 'FE' engines</i>						
352-428ci 'FE' exc. SOHC	1pr		234175	234176		
	Dyno Pak		234175-10	234176-10		
<i>7 bolts, 3 over 4 fits all wedge head Ford big blocks</i>						
429-460ci Big Block exc. Boss	1pr	135076	235175	235176	235179	235178
	Dyno Pak	35076-10	235175-10	235176-10		

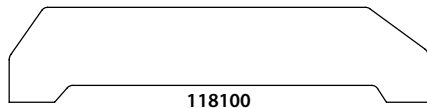

Intake Gaskets

Fitment & Dimensions	Thickness	Accu Seal E Standard Material		Accu Seal Pro Premium Materials	
		Packaged 1 Pair	Dyno Pak	Packaged 1 Pair	Dyno Pak
390-428ci 'FE' Medium Riser 1.400" x 2.100"		<i>Also fits Edelbrock Performer RPM FE</i>			
	.062"	134101	34101-10	234101	234101-10
<i>Silicone Bead Sealed Ports</i>					
Blue Thunder 'FE' Small Bore High Riser 1.400" x 2.115"	.062"	134102	34102-10	234102	234102-10
	<i>Silicone Bead Sealed Ports</i>				
429-460ci Standard Port 2.250" x 2.00" Oval		<i>Fits non-'CJ' stock port factory iron heads and similar aftermarket aluminum heads</i>			
	.062"	135101	35101-10	235101	235101-10
<i>Silicone Bead Sealed Ports</i>					
429-460ci Cobra Jet 2.560" x 2.200" Oval		<i>Fits Ford Racing CJ, SCJ and similar aftermarket heads</i>			
	.062"	135102	35102-10	235102	235102-10
Ford Racing A460 1.850" x 2.550"		<i>Fits early and late Ford Racing A460, also fits Trick Flow A460</i>			
	.062"	135104	35104-10	235104	235104-10
	.125"	135106	35106-10	<i>Silicone Bead Sealed Ports</i>	
Ford Racing B460 1.800" x 1.950"	.062"	135103	35103-10	235103	235103-10
	.125"	135109	35109-10		
Ford Racing C460 Wedge 1.800" x 2.600"	.062"	135105	35105-10	235105	235105-10
	.125"	135108	35108-10		
Profiler C460 205 Series 1.965" x 2.670" Oval	.062"	135107	35107-10	235107	235107-10
Ford Racing Hemi 1.900" x 2.00 Trim to Fit	.062"	137110	37110-10	237110	237110-10
<i>Fits "as cast ports" trim to fit</i>					
Raised Port Intake Blank	.062"	118100	18100-10	218100	218100-10
	.125"	118125	18125-10		



118100

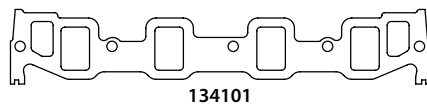

134101

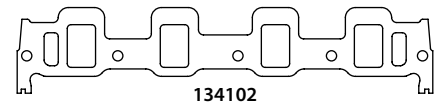

134102

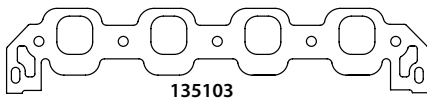

135103

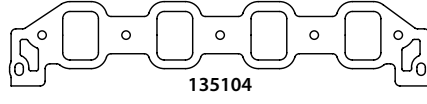

135104

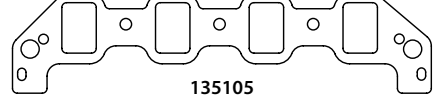

135105

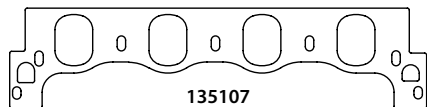

135107

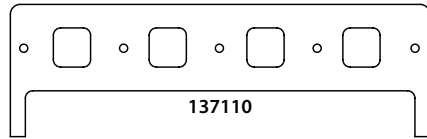

137110

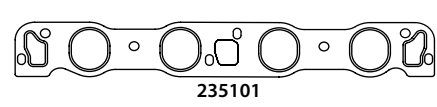

235101

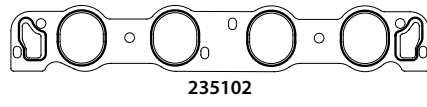

235102

Exhaust Gaskets

Fitment & Dimensions	Accu Seal E Standard Material	E Dyno Pak Bulk Pak of 10 pr	Accu Seal Pro Premium Material	Pro Dyno Pak Bulk Pak of 10 pr	Pro Copper Embossed Raised Sealing Bead	Pro Copper Annealed Flat, Soft .062" Thick
352-428ci 'FE' 1.400" x 2.060"	134080	<i>See illustrations below: Universal bolt pattern, for correct port fit measure port height relative to top bolt</i>				
		34080-10	234080	234080-10	4034	
352-428ci 'FE' 1.400" x 2.060"		<i>See illustrations below: Universal bolt pattern, for correct port fit measure port height relative to top bolt</i>				
					4134	
352-428ci 'FE' 1.400" x 2.060"		<i>See illustrations below: Universal bolt pattern, for correct port fit measure port height relative to top bolt</i>				
					4234	
429-460ci Oval 1968-86 Port 1.250" x 2.125"	135080	<i>Fits non-'CJ' wedge heads from 1968-86</i>				
		35080-10	235180	35180-10	4035	
460ci EFI 1987-97 1.750" Round	135083	<i>Composite gasket set includes gaskets to fit either of 2 EFI port designs used from 1987-97</i>				
		35083-10	235183	35183-10	4135	
460ci EFI 1987-97 1.438" x 1.474"	135083	<i>Embossed Copper exhaust gaskets should be matched to the manifold, see illustrations below</i>				
		35083-10	235183	35183-10	4235	
429-460 CJ / SCJ Heads 1.520" x 2.500"	135081	<i>Also fits Ford Racing 460 Sportsman cylinder heads</i>				
		35081-10	235181	35181-10	E35286 <i>supersedes 035286</i>	

Continued on page 53 ►

Exhaust Gaskets continued

Trick Flow A460 2.070" Round/Flat	Trick Flow A460 has rounded-flat floor ports & uses the BBC 4.840" port spread and bolt pattern					E18186 <i>supersedes 018186</i>
	135084	35084-10	235184	35184-10		
Ford Racing A460, C460, D460 2.170" x 2.020"	1984-99 Ford Racing design with 4.900" centers, rectangle ports and unique bolt pattern					E35187 <i>supersedes 035187</i>
	135085	35085-10	235185	35185-10		
Ford Racing A460 2.020" x 2.070"	2000 & later Ford Racing design A460 with 4.900" centers, rectangle ports and BBC bolt pattern at the ports					
	135082	35082-10	235182	35182-10		

See fitment instructions on page 358

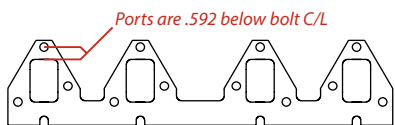

4034



4035

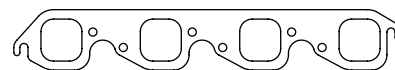

135082

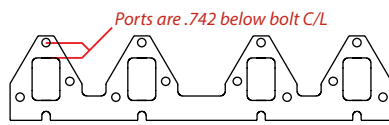

4134



4135



135083 • Includes Both Gaskets

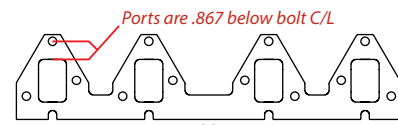

4234

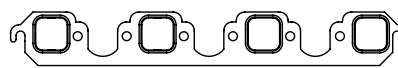

4235



135084

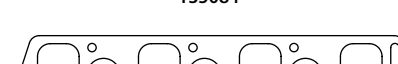

135085

Head Gaskets
Standard Bore Steel Shim Head Gasket

- Fits 1958 & later Ford 352-428ci FE engines.
- Bore opening 4.250"
- Compressed thickness: .020"
- Packaged individually.

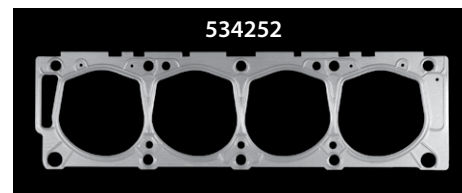

534252

Big Bore Steel Shim Head Gasket

- Fits Large Overbore 390-428ci FE Ford engines.
- Bore opening 4.400"
- Compressed thickness: .020"
- Packaged individually.

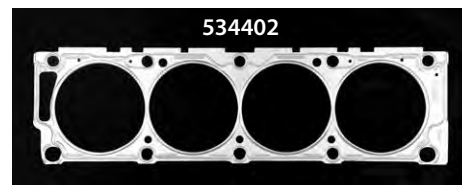

534402

Standard Bore Composite Head Gasket

- Fits 1958 & later Ford 352-428ci FE engines except 427ci.
- Bore opening 4.175"
- Compressed thickness: .042"
- Packaged individually.

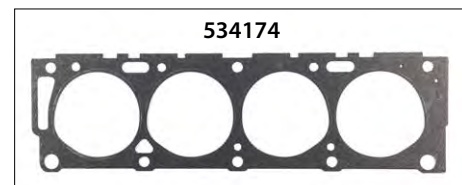

534174

Big Bore Composite Head Gasket

- Fits 390-428ci FE Ford engines including 427ci.
- Bore opening 4.300"
- Compressed thickness: .040"
- Packaged individually.

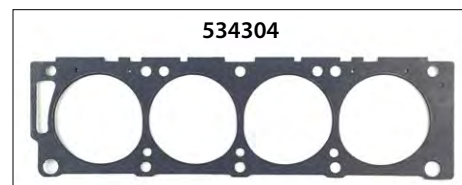

534304

Head Gaskets

Copper Racing Head Gaskets for Ford 'FE'

P34254

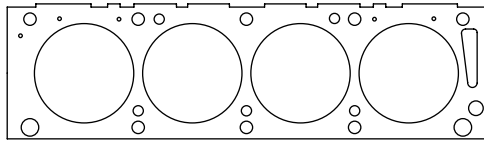

S34254

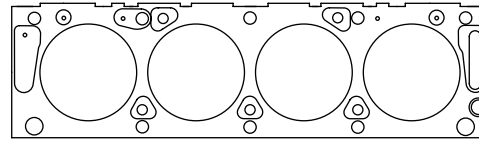

Gasket Style	Bore	Thickness							
		.021"	.032"	.043"	.050"	.062"	.072"	.080"	.093"
Pro Copper for use with o-rings & sealant	4.160" round	P34152	P34153	P34154	P34155	P34156	P34157	P34158	P34159
Titan sealed coolant passages, for use with o-rings			T34153	T34154	T34155	T34156	T34157	T34158	T34159
ICS Titan sealed coolant passages, integral combustion o-ring				S34154	S34155	S34156	S34157	S34158	S34159
Pro Copper for use with o-rings & sealant	4.200" round	P34202	P34203	P34204	P34205	P34206	P34207	P34208	P34209
Titan sealed coolant passages, for use with o-rings			T34203	T34204	T34205	T34206	T34207	T34208	T34209
ICS Titan sealed coolant passages, integral combustion o-ring				S34204	S34205	S34206	S34207	S34208	S34209
Pro Copper for use with o-rings & sealant	4.250" round	P34252	P34253	P34254	P34255	P34256	P34257	P34258	P34259
Titan sealed coolant passages, for use with o-rings			T34253	T34254	T34255	T34256	T34257	T34258	T34259
ICS Titan sealed coolant passages, integral combustion o-ring				S34254	S34255	S34256	S34257	S34258	S34259
Pro Copper for use with o-rings & sealant	4.320" round	P34322	P34323	P34324	P34325	P34326	P34327	P34328	P34329
Titan sealed coolant passages, for use with o-rings			T34323	T34324	T34325	T34326	T34327	T34328	T34329
ICS Titan sealed coolant passages, integral combustion o-ring				S34324	S34325	S34326	S34327	S34328	S34329

Packaged in Pairs. • "P" prefix supersedes "O" prefix • Pro Copper available without water holes: Use Suffix "NW"

Performance Composite Head Gasket



535504

- Fits 1968-97 Ford 385 series 429-460ci except Boss 429.
- Bore opening 4.500"
- Compressed thickness: .042"
- Packaged individually.

Copper Racing Head Gaskets for Ford 429-460ci Wedge

P35524

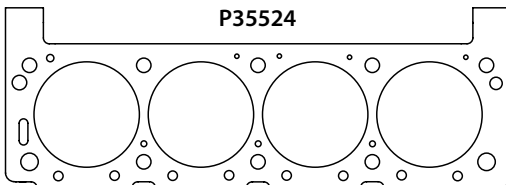

S35524

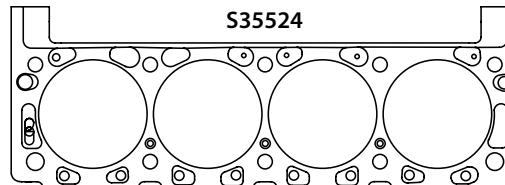

Gasket Style	Bore	Thickness							
		.021"	.032"	.043"	.050"	.062"	.072"	.080"	.093"
Pro Copper for use with o-rings & sealant	4.380" round	P35382	P35383	P35384	P35385	P35386	P35387	P35388	P35389
Titan sealed coolant passages, for use with o-rings			T35383	T35384	T35385	T35386	T35387	T35388	T35389
ICS Titan sealed coolant passages, integral combustion o-ring			<i>No Fit: Combustion chambers extend beyond 4.440" round</i>						
Pro Copper for use with o-rings & sealant	4.440" round	P35442	P35443	P35444	P35445	P35446	P35447	P35448	P35449
Titan sealed coolant passages, for use with o-rings			T35443	T35444	T35445	T35446	T35447	T35448	T35449
ICS Titan sealed coolant passages, integral combustion o-ring			<i>No Fit: Combustion chambers extend beyond 4.440" round</i>						
Pro Copper for use with o-rings & sealant	4.520" round	P35522	P35523	P35524	P35525	P35526	P35527	P35528	P35529
Titan sealed coolant passages, for use with o-rings			T35523	T35524	T35525	T35526	T35527	T35528	T35529
ICS Titan sealed coolant passages, integral combustion o-ring				S35524	S35525	S35526	S35527	S35528	S35529
Pro Copper for use with o-rings & sealant	4.570" round	P35572	P35573	P35574	P35575	P35576	P35577	P35578	P35579
Titan sealed coolant passages, for use with o-rings			T35573	T35574	T35575	T35576	T35577	T35578	T35579
ICS Titan sealed coolant passages, integral combustion o-ring				S35574	S35575	S35576	S35577	S35578	S35579
Pro Copper for use with o-rings & sealant	4.630" round	P35622	P35623	P35624	P35625	P35626	P35627	P35628	P35629
Titan sealed coolant passages, for use with o-rings			T35623	T35624	T35625	T35626	T35627	T35628	T35629
ICS Titan sealed coolant passages, integral combustion o-ring				S35624	S35625	S35626	S35627	S35628	S35629

Packaged in Pairs. • "P" prefix supersedes "O" prefix • Pro Copper available without water holes: Use Suffix "NW"

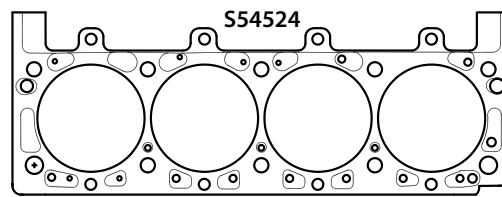
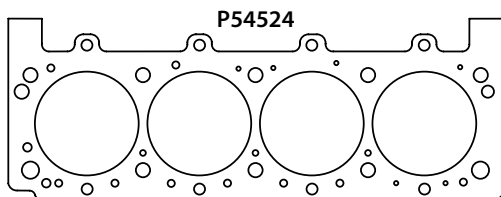
Head Gaskets
Copper Racing Head Gaskets for Ford C460 w/18 Bolt Heads

Gasket Style	Bore	Thickness							
		.032"	.043"	.050"	.062"	.072"	.080"	.093"	
Pro Copper for use with o-rings & sealant	4.520" round	P54523	P54524	P54525	P54526	P54527	P54528	P54529	
Titan sealed coolant passages, for use with o-rings		T54523	T54524	T54525	T54526	T54527	T54528	T54529	
ICS Titan sealed coolant passages, integral combustion o-ring		No Fit: Combustion chambers extend beyond 4.570" round							
Pro Copper for use with o-rings & sealant	4.570" round	P54573	P54574	P54575	P54576	P54577	P54578	P54579	
Titan sealed coolant passages, for use with o-rings		T54573	T54574	T54575	T54576	T54577	T54578	T54579	
ICS Titan sealed coolant passages, integral combustion o-ring		No Fit: Combustion chambers extend beyond 4.570" round							
Pro Copper for use with o-rings & sealant	4.630" round	P54623	P54624	P54625	P54626	P54627	P54628	P54629	
Titan sealed coolant passages, for use with o-rings		T54623	T54624	T54625	T54626	T54627	T54628	T54629	
ICS Titan sealed coolant passages, integral combustion o-ring		S54624	S54625	S54626	S54627	S54628	S54629		

Packaged in Pairs. • Pro Copper available without water holes: Use Suffix "NW" • "P" prefix supersedes "0" prefix

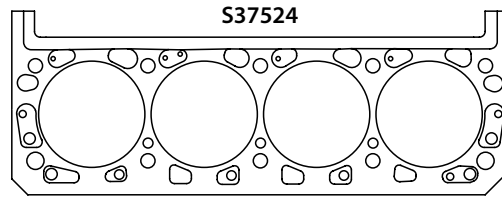
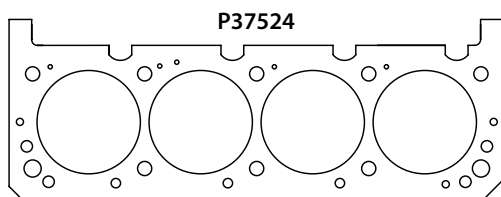
Copper Racing Head Gaskets for Ford Racing Hemi, C & C Hemi with 4.900" Bore Centers

Gasket Style	Bore	Thickness							
		.032"	.043"	.050"	.062"	.072"	.080"	.093"	
Pro Copper for use with o-rings & sealant	4.520" round	P37523	P37524	P37525	P37526	P37527	P37528	P37529	
Titan sealed coolant passages, for use with o-rings		T37523	T37524	T37525	T37526	T37527	T37528	T37529	
ICS Titan sealed coolant passages, integral combustion o-ring		S37524	S37525	S37526	S37527	S37528	S37529		
Pro Copper for use with o-rings & sealant	4.570" round	P37573	P37574	P37575	P37576	P37577	P37578	P37579	
Titan sealed coolant passages, for use with o-rings		T37573	T37574	T37575	T37576	T37577	T37578	T37579	
ICS Titan sealed coolant passages, integral combustion o-ring		S37574	S37575	S37576	S37577	S37578	S37579		
Pro Copper for use with o-rings & sealant	4.630" round	P37623	P37624	P37625	P37626	P37627	P37628	P37629	
Titan sealed coolant passages, for use with o-rings		T37623	T37624	T37625	T37626	T37627	T37628	T37629	
ICS Titan sealed coolant passages, integral combustion o-ring		S37624	S37625	S37626	S37627	S37628	S37629		

"P" prefix supersedes "0" prefix • Packaged in Pairs. • Pro Copper available without water holes: Use Suffix "NW"

Short Block Gaskets & Seals

Application	Qty	Oil Pan Gasket	Front Cover Gaskets TC, WP, FP	Water Pump	Timing Cover Seal	Timing Cover Set	Rear Main Seal	Fuel Pump	Water Outlet
2000 & Later Genral Motors Ecotec Pontiac 'Iron Duke' 151ci	Please see Engine Master Gaskets Section: General Motors 4 Cyl: page 236								

Intake Gaskets

Fitment	Thickness	Accu Seal E Standard Material		Accu Seal Pro Premium Materials	
		Packaged 1 Pair	Dyno Pak	Packaged 1 Pair	Dyno Pak
2000 & Later GM Ecotec 2.0-2.4L DOHC	.062"	922411	922411-10	922412	922412-10
				<i>Silicone Bead Sealed Ports</i>	
Saturn 1.9L DOHC	.062"	922611	922611-10	922612	922612-10
				<i>Silicone Bead Sealed Ports</i>	
Iron Duke, Super Duty 4	.062"	911611	911611-10	911612	911612-10

922411

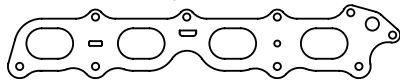

Exhaust Gaskets

Fitment & Dimensions	Accu Seal E Standard Material	E Dyno Pak Bulk Pak of 10 pr	Accu Seal Pro Premium Material	Pro Dyno Pak Bulk Pak of 10 pr	Pro Copper Embossed Raised Sealing Bead	Pro Copper Annealed Flat, Soft .062" Thick
<i>Embossed copper gasket fits factory iron manifold or machined flat header flange</i>						
2000 & Later GM Ecotec DOHC 2.0-2.4L	924481	924481-10	924482	924482-10	9431	
Saturn 1.9L SOHC LKO engine	922680	922680-10				
<i>Composite gasket set includes EGR & 3 bolt collector gaskets</i>						
Saturn 1.9L DOHC LLO Engine	922681	922681-10	922682	922682-10	9446	
Pontiac Iron Duke, Super Duty 4	911681	911681-10	911682	911682-10		

See fitment instructions on page 358

9431



9446



Head Gaskets

Copper Racing Head Gaskets for GM Inline 4 Engines

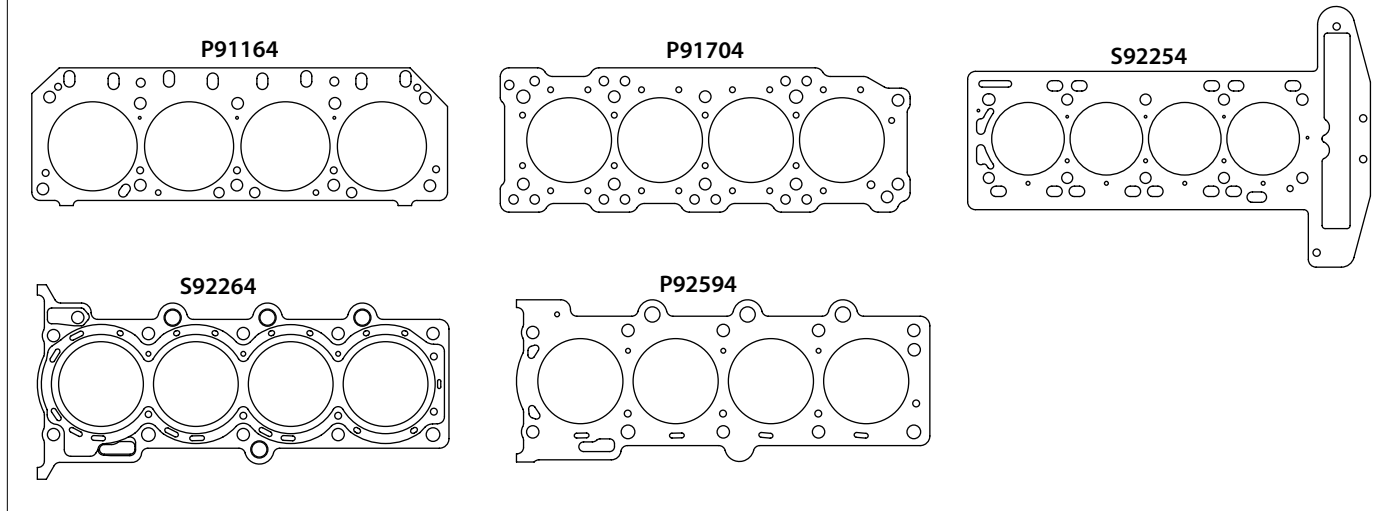

Continued on page 58 ►

Head Gaskets continued
Copper Racing Head Gaskets for GM Inline 4 Engines

Gasket Style	Bore	Thickness							
		.021"	.032"	.043"	.050"	.062"	.072"	.080"	.093"
2.0-2.4L GM Ecotec DOHC	3.500" round	P92252	P92253	P92254	P92255	P92256	P92257	P92258	P92259
			T92253	T92254	T92255	T92256	T92257	T92258	T92259
Saturn 1.9L DOHC	3.305" round	P92592	P92593	P92594	P92595	P92596	P92597	P92598	P92599
Saturn 1.9L SOHC	3.305" round	P92262	P92263	P92264	P92265	P92266	P92267	P92268	P92269
			T92263	T92264	T92265	T92266	T92267	T92268	T92269
GM Quad 4 DOHC 2.3L & 2.4L	3.625" round	P91702	P91703	P91704	P91705	P91706	P91707	P91708	P91709
			T91703	T91704	T91705	T91706	T91707	T91708	T91709
Pontiac Iron Duke, Super Duty 4	4.060" round	P91162	P91163	P91164	P91165	P91166	P91167	P91168	P91169

"P" Prefix: Pro Copper for use with o-rings & sealant • "T" Prefix: Titan sealed coolant passages, for use with o-rings
 "S" Prefix: ICS Titan sealed coolant passages, integral combustion o-ring • "P" Prefix supersedes "O" Prefix

HONDA
Intake Gaskets

Fitment	Thickness	Accu Seal E Standard Material		Accu Seal Pro Premium Materials	
		Packaged 1 Pair	Dyno Pak	Packaged 1 Pair	Dyno Pak
1992-2000 D-16 SOHC	.062"	913611	913611-10	913612	913612-10
B Series DOHC VTEC	.062"	913811	913811-10	913812	913812-10
H22A, H23 DOHC	.062"	914011	914011-10	914012	914012-10
F20C, F22C DOHC	.062"	923111	923111-10	923112	923112-10

Exhaust Gaskets

Fitment	Accu Seal E Standard Material	E Dyno Pak Bulk Pak of 10 pr	Accu Seal Pro Premium Material	Pro Dyno Pak Bulk Pak of 10 pr	Pro Copper Embossed Raised Sealing Bead	Pro Copper Annealed Flat, Soft .062" Thick
D-16 SOHC	Embossed copper gasket seals factory iron manifold or machined flat header flange					
	913681	913681-10	913682	913682-10	9401	
B Series DOHC VTEC	Embossed copper gasket seals factory iron manifold or machined flat header flange					
	913881	913881-10	913882	913882-10	9404	
H22A DOHC	Embossed copper gasket seals factory iron manifold or machined flat header flange					
	914081	914081-10	914082	914082-10	9430	
H23A, F22A	Embossed copper gasket seals factory iron manifold or machined flat header flange					
	914181	914181-10	914182	914182-10	9402	
F22B6	Embossed copper gasket seals factory iron manifold or machined flat header flange					
	921781	921781-10	921782	921782-10	9403	
F20C, F22C DOHC	923181	923181-10	923182	923182-10	9467	

See fitment instructions on page 358

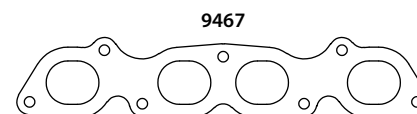
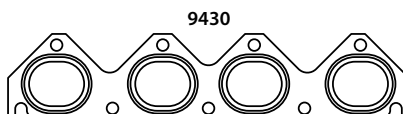
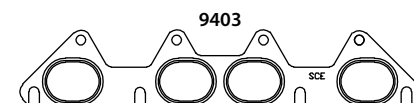

Head Gaskets

Copper Racing Head Gaskets for Honda Inline 4 Cylinder Engines

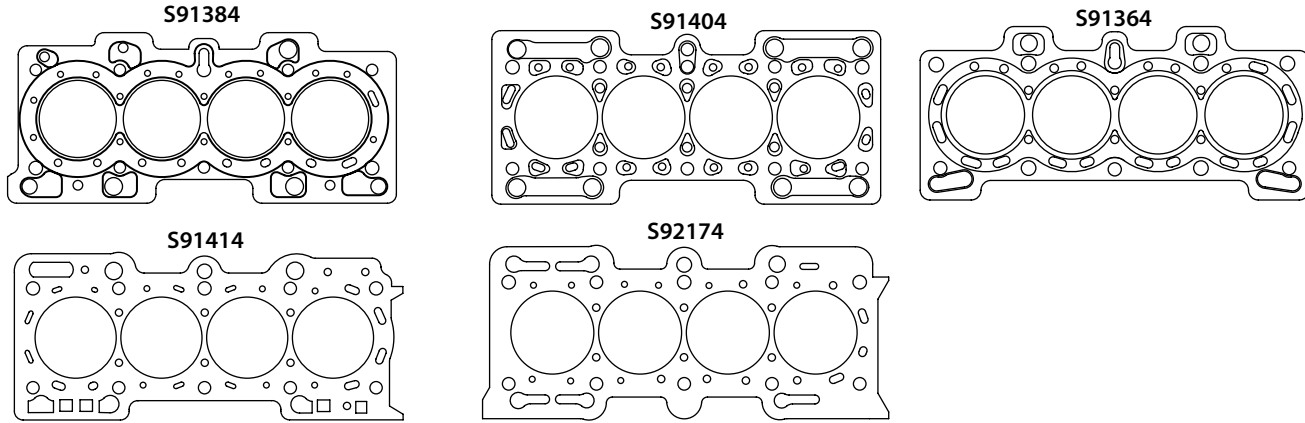

Engine Code Application	Bore	Thickness							
		.021"	.032"	.043"	.050"	.062"	.072"	.080"	.093"
1992-00 D16 SOHC	3.00" 76.2mm round	P91362	P91363	P91364	P91365	P91366	P91367	P91368	P91369
			T91363	T91364	T91365	T91366	T91367	T91368	T91369
B Series DOHC VTEC	3.250" 82.5mm round	P91382	P91383	P91384	P91385	P91386	P91387	P91388	P91389
			T91383	T91384	T91385	T91386	T91387	T91388	T91389
				S91384	S91385	S91386	S91387	S91388	S91389
H22A DOHC	3.500" 88.9mm round	P91402	P91403	P91404	P91405	P91406	P91407	P91408	P91409
			T91403	T91404	T91405	T91406	T91407	T91408	T91409
H23A DOHC	3.500" 88.9mm round	P91412	P91413	P91414	P91415	P91416	P91417	P91418	P91419
				S91404	S91405	S91406	S91407	S91408	S91409
F20C, F22C DOHC	3.437" 87.3mm round	P92172	P92173	P92174	P92175	P92176	P92177	P92178	P92179
			T92173	T92174	T92175	T92176	T92177	T92178	T92179
				S92174	S92175	S92176	S92177	S92178	S92179

"P" Prefix: Pro Copper for use with o-rings & sealant • "T" Prefix: Titan sealed coolant passages, for use with o-rings
 "S" Prefix: ICS Titan sealed coolant passages, integral combustion o-ring • "P" Prefix supersedes "0" Prefix

MITSUBISHI

Intake Gaskets

Fitment	Thickness	Accu Seal E Standard Material		Accu Seal Pro Premium Materials	
		Packaged 1 Pair	Dyno Pak	Packaged 1 Pair	Dyno Pak
1990-94 4G63 w/6 Bolt flywheel	.062"	915211	915211-10	915212	915212-10
4G63 EVO	.062"	926711	926711-10	926712	926712-10

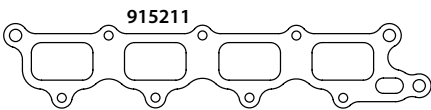

Exhaust Gaskets

Fitment	Accu Seal E Standard Material	E Dyno Pak Bulk Pak of 10 pr	Accu Seal Pro Premium Material	Pro Dyno Pak Bulk Pak of 10 pr	Pro Copper Embossed Raised Sealing Bead	Pro Copper Annealed Flat, Soft .062" Thick
4G63 Manifold to Head Fits all including EVO					Embossed copper gasket seals factory iron manifold or machined flat header flange	
					9405	
4G63 Turbine Housing to Manifold					Embossed copper gasket seals factory iron manifold or machined flat header flange	
					9449	
4G64 2.4L Manifold to Head					Embossed copper gasket seals factory iron manifold or machined flat header flange	
					9448	

See fitment instructions on page 358

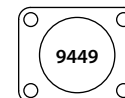
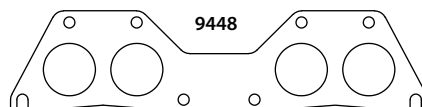
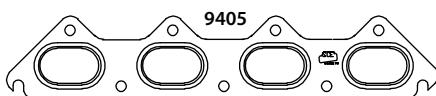

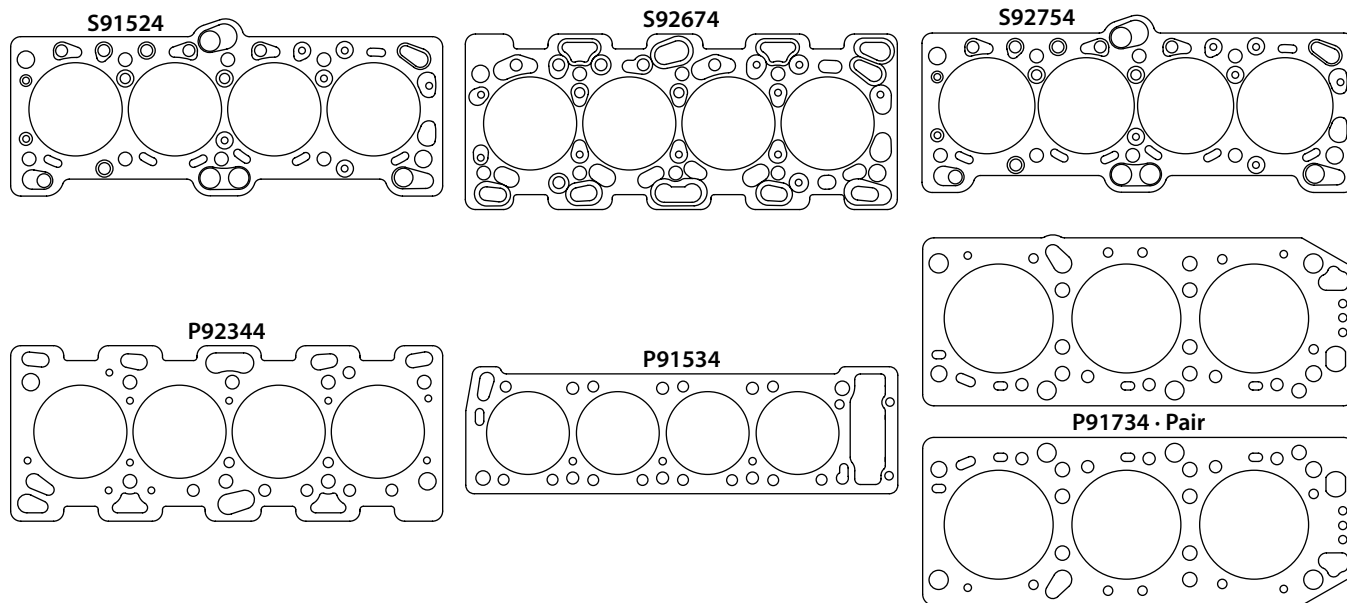
Head Gaskets
Copper Racing Head Gaskets for Mitsubishi Inline 4 Cylinder Engines

Engine Code Application	Bore	Thickness							
		.021"	.032"	.043"	.050"	.062"	.072"	.080"	.093"
1989 & Later 2.0L 4G63 (T) DOHC except EVO	3.375" 85.7mm round	P91522	P91523	P91524	P91525	P91526	P91527	P91528	P91529
			T91523	T91524	T91525	T91526	T91527	T91528	T91529
				S91524	S91525	S91526	S91527	S91528	S91529
1989 & Later 2.0L 4G63 (T) DOHC Big Bore except EVO	3.437" 87.3mm round	P92752	P92753	P92754	P92755	P92756	P92757	P92758	P92759
			T92753	T92754	T92755	T92756	T92757	T92758	T92759
				S92754	S92755	S92756	S92757	S92758	S92759
2003 & Later 2.0L 4G63 EVO	3.437" 87.3mm round	P92672	P92673	P92674	P92675	P92676	P92677	P92678	P92679
			T92673	T92674	T92675	T92676	T92677	T92678	T92679
				S92674	S92675	S92676	S92677	S92678	S92679
2.4L 4G64 SOHC	3.437" 87.3mm round	P92342	P92343	P92344	P92345	P92346	P92347	P92348	P92349
2.6L 4G54 SOHC	3.670" 93.2mm round	P91532	P91533	P91534	P91535	P91536	P91537	P91538	P91539
			T91533	T91534	T91535	T91536	T91537	T91538	T91539
				S91534	S91535	S91536	S91537	S91538	S91539
1991-93 3.0L 6G72 DOHC	3.670" 93.2mm round	P91732	P91733	P91734	P91735	P91736	P91737	P91738	P91739

"P" Prefix: Pro Copper for use with o-rings & sealant • "T" Prefix: Titan sealed coolant passages, for use with o-rings
 "S" Prefix: ICS Titan sealed coolant passages, integral combustion o-ring • "P" Prefix supersedes "O" Prefix

Exhaust Gaskets

Engine Code Application	Accu Seal E Standard Material	E Dyno Pak Bulk Pak of 10 pr	Accu Seal Pro Premium Material	Pro Dyno Pak Bulk Pak of 10 pr	Pro Copper Embossed Raised Sealing Bead	Pro Copper Annealed Flat, Soft .062" Thick
SR20DE(T) 2.0L DOHC					9416	
KA24DE 2.4L DOHC					9417	
VG30DET (TT) Turbo 3.0L V-6					9437	
VQ35 3.5L V-6					9469	

See fitment instructions on page 358

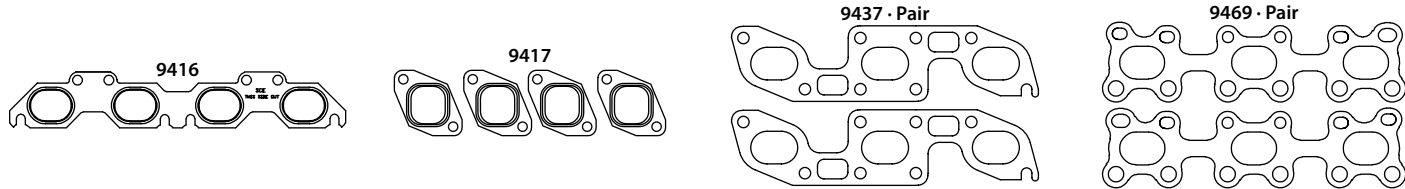

Head Gaskets

Copper Racing Head Gaskets for Nissan Engines

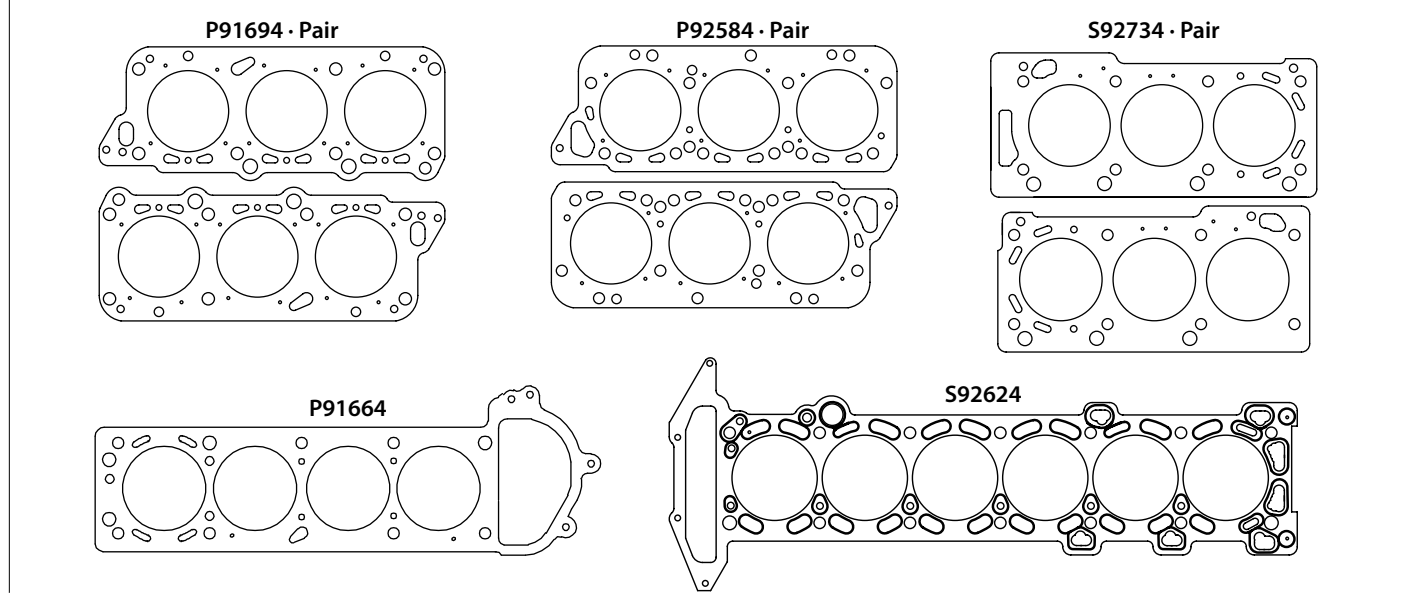

Engine Code Application	Bore	Thickness							
		.021"	.032"	.043"	.050"	.062"	.072"	.080"	.093"
SR20DE(T) 2.0L DOHC	3.437" 87.9mm round	P91652	P91653	P91654	P91655	P91656	P91657	P91658	P91659
			T91653	T91654	T91655	T91656	T91657	T91658	T91659
				S91654	S91655	S91656	S91657	S91658	S91659
KA24DE 2.4L DOHC	3.500" 88.9mm round	P91662	P91663	P91664	P91665	P91666	P91667	P91668	P91669
VG30ET 3.0L V-6	3.500" 88.9mm round	P92582	P92583	P92584	P92585	P92586	P92587	P92588	P92589
VG30DET, (TT) 3.0L Turbo V-6	3.500" 88.9mm round	P91692	P91693	P91694	P91695	P91696	P91697	P91698	P91699
VQ35DE DOHC 3.5L V-6	3.850" 97.8mm round	P92732	P92733	P92734	P92735	P92736	P92737	P92738	P92739
			T92733	T92734	T92735	T92736	T92737	T92738	T92739
				S92734	S92735	S92736	S92737	S92738	S92739
TB48DE Inline 6 Cylinder	3.950" 100.3mm round	P92622	P92623	P92624	P92625	P92626	P92627	P92628	P92629
			T92623	T92624	T92625	T92626	T92627	T92628	T92629
				S92624	S92625	S92626	S92627	S92628	S92629

"P" Prefix: Pro Copper for use with o-rings & sealant • "T" Prefix: Titan sealed coolant passages, for use with o-rings
 "S" Prefix: ICS Titan sealed coolant passages, integral combustion o-ring • "P" Prefix supersedes "O" Prefix

Short Block Gaskets & Seals

Application	Qty	Oil Pan Gasket	Front Cover Gaskets TC, WP, FP	Water Pump	Timing Cover Seal	Timing Cover Set	Rear Main Seal	Fuel Pump	Water Outlet
1965-90 307-350ci Olds V-8	<i>Accu-Seal E standard gasket materials, nitrile or silicone seals.</i>								
	Each	179090	17900	17901	17902	17903	17904	17906	17908
	Dyno pak	79090-10	7900-10	7901-10	7902-10		7904-10	7906-10	7908-10
1965-76 400, 425, 455ci Olds V-8	<i>Accu-Seal E standard gasket materials, nitrile or silicone seals.</i>								
	Each	179090	17900	17901	17902	17903	17905 except 403	17906	17908
	Dyno Pak	79090-10	7900-10	7901-10	7902-10		7905-10	7906-10	7908-10
	<i>Accu-Seal Pro premium gasket materials, Fluoroelastomer (Viton®) seals, molded water outlet.</i>								
	Each	279090							
	Dyno Pak	279090-10							

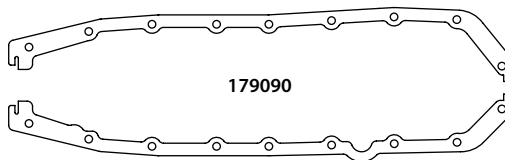
Valve Cover Gaskets

Fitment	Qty	Cork, Hi Density 5/16" Thick <i>Street/Strip</i>	Laminated Silicone Cork 1/8" Thick <i>Racing/Hi Vacuum</i>	Laminated Silicone Cork 1/4" Thick <i>Racing/Hi Vacuum</i>	Molded Silicone Rubber <i>Street Performance</i>	Steel Core Teflon® Coated .078" Thick <i>Severe Duty</i>
1965-76 307-455ci Oldsmobile V-8	<i>10 bolts, 5 over 5 perimeter pattern</i>					
	1pr	179076	279175	279176		279178
	Dyno Pak	79076-10	79175-10	79176-10		79178-10

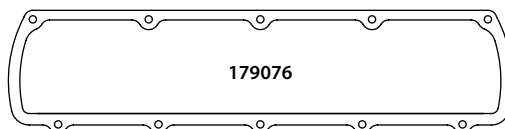
Intake Gaskets

Fitment & Dimensions	Thickness	Accu Seal E Standard Material		Accu Seal Pro Premium Materials	
		<i>Packaged 1 Pair</i>	<i>Dyno Pak</i>	<i>Packaged 1 Pair</i>	<i>Dyno Pak</i>
307-350ci 'Small Block' 1.300" x 2.00"	.062"	179101	79101-10	279101	279101-10
		<i>Silicone Bead Sealed Ports</i>			
400-455ci 'Big Block' 1.400" x 2.400"	.062"	<i>Also fits Edelbrock Performer RPM Olds</i>			
		179102	79102-10	279102	279102-10
<i>Silicone Bead Sealed Ports</i>					
Batten Olds (as cast ports) 1.350" x 2.250"	.062"	179103	79103-10	279103	279103-10
Batten Olds (Ported) 1.500" x 2.530"	.062"	179104	79104-10	279104	279104-10

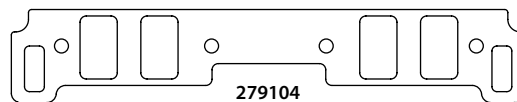
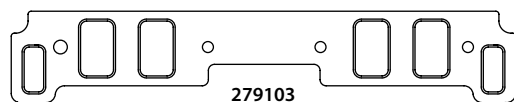
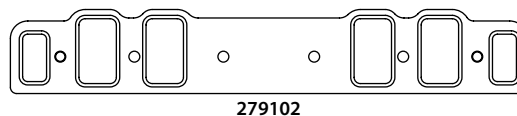
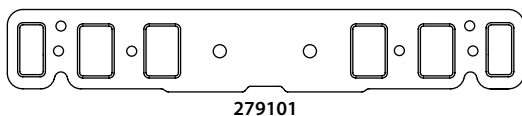

Exhaust Gaskets

Fitment & Dimensions	Accu Seal E <i>Standard Material</i>	E Dyno Pak <i>Bulk Pak of 10 pr</i>	Accu Seal Pro <i>Premium Material</i>	Pro Dyno Pak <i>Bulk Pak of 10 pr</i>	Pro Copper Embossed <i>Raised Sealing Bead</i>	Pro Copper Annealed <i>Flat, Soft .062" Thick</i>
400-455ci Stock Port 1.470" x 2.100"	179080	79080-10	279180	79180-10	4079	E79186 <i>supersedes 079186</i>
Edelbrock Performer RPM Olds Aluminum 1.480" x 1.500"	<i>Port size matches the head, embossment matches manifold & most headers</i>					
Batten Olds 1.800" x 1.575"	179082	79082-10	279182	79182-10	4179	E79286 <i>supersedes 079286</i>
Bulldog Raised Port 2.375" Round	179083	79083-10	279183	79183-10		

See fitment instructions on page 358

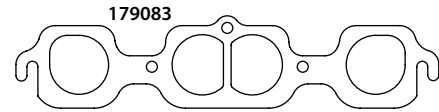
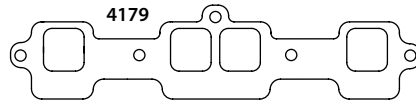
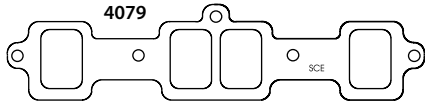

Head Gaskets

Performance Composite Head Gasket



- Fits 1965-76 Olds 400-455ci V-8 (gasoline) except 403ci.
- Bore opening: 4.270"
- Compressed Thickness: .045"
- Packaged individually.

Copper Racing Head Gaskets for Oldsmobile V8

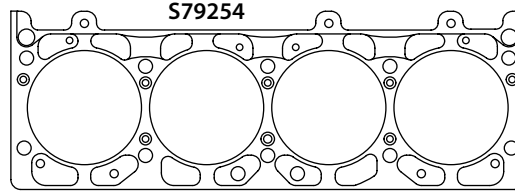
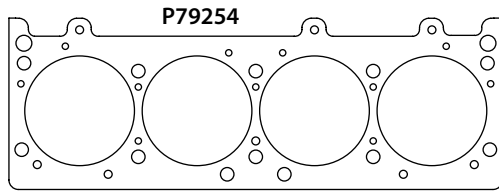

Gasket Style	Bore	Thickness							
		.021"	.032"	.043"	.050"	.062"	.072"	.080"	.093"
Pro Copper for use with o-rings & sealant	4.200" round	P79202	P79203	P79204	P79205	P79206	P79207	P79208	P79209
Titan sealed coolant passages, for use with o-rings			T79203	T79204	T79205	T79206	T79207	T79208	T79209
ICS Titan sealed coolant passages, integral combustion o-ring				S79204	S79205	S79206	S79207	S79208	S79209
Pro Copper for use with o-rings & sealant	4.250" round	P79252	P79253	P79254	P79255	P79256	P79257	P79258	P79259
Titan sealed coolant passages, for use with o-rings			T79253	T79254	T79255	T79256	T79257	T79258	T79259
ICS Titan sealed coolant passages, integral combustion o-ring				S79254	S79255	S79256	S79257	S79258	S79259
Pro Copper for use with o-rings & sealant	4.320" round	P79322	P79323	P79324	P79325	P79326	P79327	P79328	P79329
Titan sealed coolant passages, for use with o-rings			T79323	T79324	T79325	T79326	T79327	T79328	T79329
ICS Titan sealed coolant passages, integral combustion o-ring				S79324	S79325	S79326	S79327	S79328	S79329
Pro Copper for use with o-rings & sealant	4.380" round	P79382	P79383	P79384	P79385	P79386	P79387	P79388	P79389
Titan sealed coolant passages, for use with o-rings			T79383	T79384	T79385	T79386	T79387	T79388	T79389
ICS Titan sealed coolant passages, integral combustion o-ring				S79384	S79385	S79386	S79387	S79388	S79389

"P" prefix supersedes "O" prefix • Pro Copper available without water holes: Use Suffix "NW" • Packaged in Pairs.

Short Block Gaskets & Seals

Application	Qty	Oil Pan Gasket	Front Cover Gaskets TC, WP, FP	Water Pump	Timing Cover Seal	Timing Cover Set	Rear Main Seal	Fuel Pump	Water Outlet	
<i>Accu-Seal E standard gasket materials, nitrile or silicone seals.</i>										
1959-81 301-400ci V-8	Each	128090	12800	12801	12802	12803		12806	12808	
	Dyno Pak	28090-10	2800-10	2801-10	2802-10			2806-10	2808-10	
	<i>Accu-Seal Pro premium gasket materials, Fluoroelastomer (Viton®) seals, molded water outlet.</i>									
	Each	228090 1 pc molded silicone						22804 2 pc Viton®		
Dyno Pak							2804-10			
<i>Accu-Seal E standard gasket materials, nitrile or silicone seals.</i>										
1963-74 421-455ci V-8	Each	128090	12800	12801	12802	12803		12806	12808	
	Dyno Pak	28090-10	2800-10	2801-10	2802-10			2806-10	2808-10	
	<i>Accu-Seal Pro premium gasket materials, Fluoroelastomer (Viton®) seals, molded water outlet.</i>									
	Each	228090 1 pc molded silicone						22805 2 pc Viton®		
Dyno Pak							2805-10			

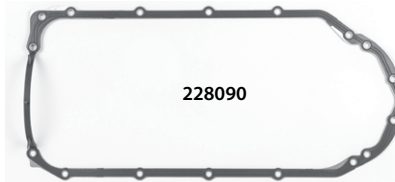
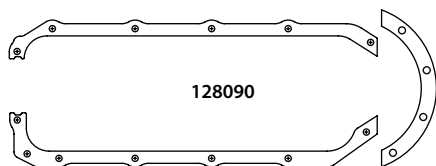
Valve Cover Gaskets

Fitment	Qty	Cork, Hi Density 5/16" Thick Street/Strip	Laminated Silicone Cork 1/8" Thick Racing/Hi Vacuum	Laminated Silicone Cork 1/4" Thick Racing/Hi Vacuum	Molded Silicone Rubber Street Performance	Steel Core Teflon® Coated .078" Thick Severe Duty
<i>4 bolts, 2 over 2 perimeter pattern</i>						
301-455ci Pontiac V-8	1pr	128076	228175	228176		
	Dyno Pak	28076-10	28175-10	28176-10		

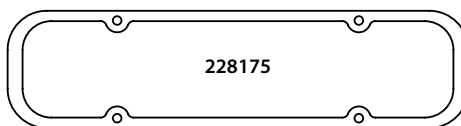
Intake Gaskets

Fitment & Dimensions	Thickness	Accu Seal E Standard Material		Accu Seal Pro Premium Materials	
		Packaged 1 Pair	Dyno Pak	Packaged 1 Pair	Dyno Pak
Stock Port 1.075" x 2.025"	.062"	128101	28101-10	228101	228101-10
<i>Silicone Bead Sealed Ports</i>					
Modified Port 1.060" x 2.100"	.062"	128102	28102-10	228102	228102-10
Modified Port 1.125" x 2.275"	.062"	128103	28103-10	228103	228103-10
<i>Silicone Bead Sealed Ports</i>					
Modified Port 1.125" x 2.240"	.062"	<i>Gasket shape provides extra material at top for porting</i>			
Modified Port 1.175" x 2.300"	.062"	128104	28104-10	228104	228104-10
Modified Port 1.175" x 2.300"	.062"	128105	28105-10	228105	228105-10
Modified Port 1.135" x 2.350"	.062"	128106	28106-10	228106	228106-10
Ram Air / Super Duty 1.075" x 2.200"	.062"	<i>Also fits Edelbrock Performer & Performer RPM Pontiac aluminum heads</i>			
		128107	28107-10	228107	228107-10
<i>Silicone Bead Sealed Ports</i>					

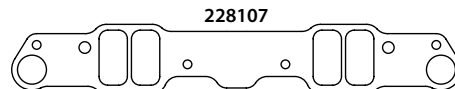
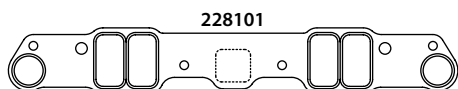
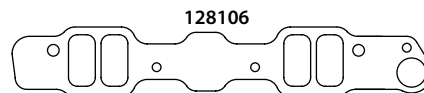
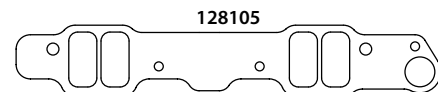
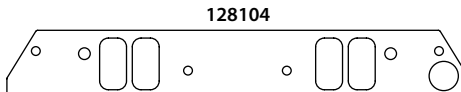
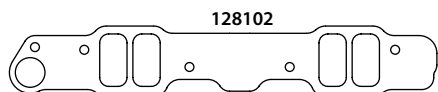

Exhaust Gaskets

Fitment & Dimensions	Accu Seal E <i>Standard Material</i>	E Dyno Pak <i>Bulk Pak of 10 pr</i>	Accu Seal Pro <i>Premium Material</i>	Pro Dyno Pak <i>Bulk Pak of 10 pr</i>	Pro Copper Embossed <i>Raised Sealing Bead</i>	Pro Copper Annealed <i>Flat, Soft .062" Thick</i>
350-455 Pontiac D-Port 1.900" Tall	<i>Gaskets match 455ci factory heads with 'D' center ports & oval outer ports</i>					
	128080	28080-10	228180	28180-10	4128	E28186 <i>supersedes 028186</i>
Ram Air / Super Duty 1.875" Round	<i>Also fits Edelbrock Performer & Performer RPM Pontiac heads with 2" Ram Air style headers</i>					
	128081	28081-10	228181	28181-10	4028	E28286 <i>supersedes 028286</i>

See fitment instructions on page 358

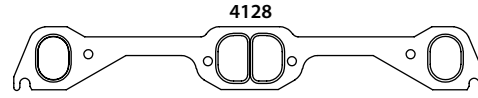
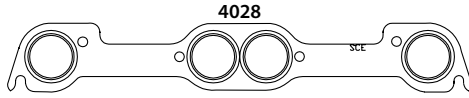

Head Gaskets

Performance Composite Head Gasket

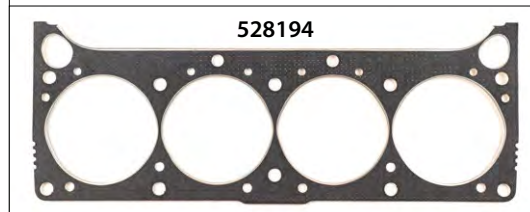

- Fits 400-455ci Pontiac V-8.
- Bore opening: 4.190"
- Compressed Thickness: .045"
- Packaged individually.

Copper Racing Head Gaskets for Pontiac V8

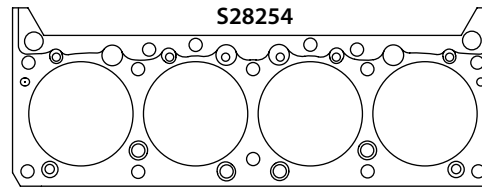
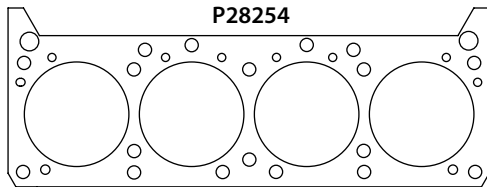

Gasket Style	Bore	Thickness							
		.021"	.032"	.043"	.050"	.062"	.072"	.080"	.093"
Pro Copper for use with o-rings & sealant	4.160" round	P28152	P28153	P28154	P28155	P28156	P28157	P28158	P28159
Titan sealed coolant passages, for use with o-rings			T28153	T28154	T28155	T28156	T28157	T28158	T28159
ICS Titan sealed coolant passages, integral combustion o-ring				S28154	S28155	S28156	S28157	S28158	S28159
Pro Copper for use with o-rings & sealant	4.200" round	P28202	P28203	P28204	P28205	P28206	P28207	P28208	P28209
Titan sealed coolant passages, for use with o-rings			T28203	T28204	T28205	T28206	T28207	T28208	T28209
ICS Titan sealed coolant passages, integral combustion o-ring				S28204	S28205	S28206	S28207	S28208	S28209
Pro Copper for use with o-rings & sealant	4.250" round	P28252	P28253	P28254	P28255	P28256	P28257	P28258	P28259
Titan sealed coolant passages, for use with o-rings			T28253	T28254	T28255	T28256	T28257	T28258	T28259
ICS Titan sealed coolant passages, integral combustion o-ring				S28254	S28255	S28256	S28257	S28258	S28259
Pro Copper for use with o-rings & sealant	4.320" round	P28322	P28323	P28324	P28325	P28326	P28327	P28328	P28329
Titan sealed coolant passages, for use with o-rings			T28323	T28324	T28325	T28326	T28327	T28328	T28329
ICS Titan sealed coolant passages, integral combustion o-ring				S28324	S28325	S28326	S28327	S28328	S28329
Pro Copper for use with o-rings & sealant	4.380" round	P28382	P28383	P28384	P28385	P28386	P28387	P28388	P28389
Titan sealed coolant passages, for use with o-rings			T28383	T28384	T28385	T28386	T28387	T28388	T28389
ICS Titan sealed coolant passages, integral combustion o-ring				S28384	S28385	S28386	S28387	S28388	S28389

Packaged in Pairs. • "P" prefix supersedes "O" prefix • Pro Copper available without water holes: Use Suffix "NW"

Exhaust Gaskets

Fitment	Accu Seal E Standard Material	E Dyno Pak Bulk Pak of 10 pr	Accu Seal Pro Premium Material	Pro Dyno Pak Bulk Pak of 10 pr	Pro Copper Embossed Raised Sealing Bead	Pro Copper Annealed Flat, Soft .062" Thick	
WRX 3 Bolt Header Gasket	Set contains 2 pieces					9444	
WRX Header to Turbo Pipe					9441		
WRX Three Bolt Turbine Inlet					9442		
WRX 5 Bolt Turbine Outlet					9443		
2 Bolt 3" Flange Gasket					9447		

See fitment instructions on page 358

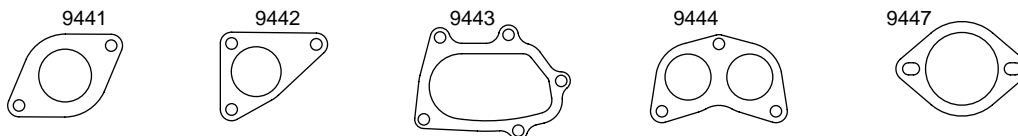

Head Gaskets

Copper Racing Head Gaskets for Subaru Flat 4 Cylinder Engines

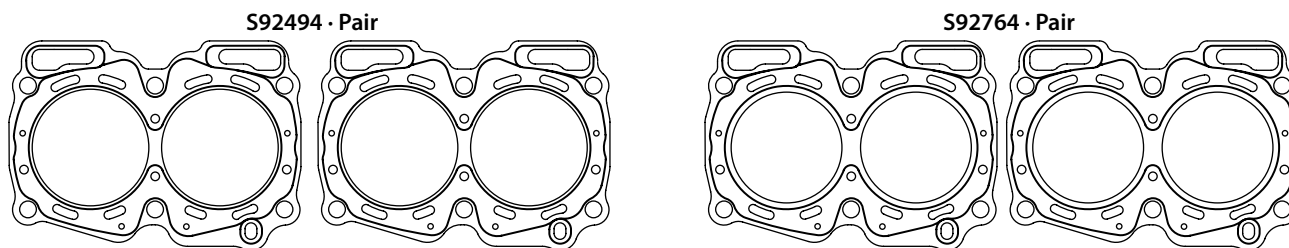

Engine Code Application	Bore	Thickness							
		.021"	.032"	.043"	.050"	.062"	.072"	.080"	.093"
EJ20 2.0L Standard Bore	3.750" 95.3mm round	P92762	P92763	P92764	P92765	P92766	P92767	P92768	P92769
			T92763	T92764	T92765	T92766	T92767	T92768	T92769
				S92764	S92765	S92766	S92767	S92768	S92769
EJ20 2.0L Overbore	3.850" 97.8mm round	P92772	P92773	P92774	P92775	P92776	P92777	P92778	P92779
			T92773	T92774	T92775	T92776	T92777	T92778	T92779
				S92774	S92775	S92776	S92777	S92778	S92779
EJ25 2.5L Standard Bore	3.950" 100.3mm round	P92782	P92783	P92784	P92785	P92786	P92787	P92788	P92789
			T92783	T92784	T92785	T92786	T92787	T92788	T92789
				S92784	S92785	S92786	S92787	S92788	S92789
EJ25 2.5L Overbore	4.010" 101.9mm round	P92492	P92493	P92494	P92495	P92496	P92497	P92498	P92499
			T92493	T92494	T92495	T92496	T92497	T92498	T92499
				S92494	S92495	S92496	S92497	S92498	S92499
EJ25 Big Bore	4.060" 103.1mm round	P92792	P92793	P92794	P92795	P92796	P92797	P92798	P92799
			T92793	T92794	T92795	T92796	T92797	T92798	T92799
				S92794	S92795	S92796	S92797	S92798	S92799

"P" Prefix: Pro Copper for use with o-rings & sealant • "T" Prefix: Titan sealed coolant passages, for use with o-rings
 "S" Prefix: ICS Titan sealed coolant passages, integral combustion o-ring • "P" Prefix supersedes "O" Prefix

Intake Gaskets

Fitment	Thickness	Accu Seal E Standard Material		Accu Seal Pro Premium Materials	
		Packaged 1 Pair	Dyno Pak	Packaged 1 Pair	Dyno Pak
22R 2.4L SOHC	.062"	918411	918411-10	918412	918412-10
2AZFE 2.4L DOHC	.062"	926311	926311-10	926312	926312-10

Exhaust Gaskets

Fitment	Accu Seal E Standard Material	E Dyno Pak Bulk Pak of 10 pr	Accu Seal Pro Premium Material	Pro Dyno Pak Bulk Pak of 10 pr	Pro Copper Embossed Raised Sealing Bead	Pro Copper Annealed Flat, Soft .062" Thick
22R Stock Port Stock Teardrop Shape		Seals all stock iron manifolds and flat header flanges Note: Raised bead headers must match embossment			9415A	
22R w/ Race Port 1.5" Round		Fits racing heads with weld-filled round exhaust ports & round port headers			9415	
3SFE / 5SFE Celica, Camry, MR2		Seals all stock iron manifolds and flat header flanges Note: Raised bead headers must match embossment			9418	
2RZFE / 3RZFE Tacoma, 4Runner		Seals all stock iron manifolds and flat header flanges Note: Raised bead headers must match embossment			9425	
7MGTE Supra through 1992		Seals all stock iron manifolds and flat header flanges Note: Raised bead headers must match embossment			9420	
2JZ-GTE Twin Turbo Supra Mk 4		Seals all stock iron manifolds and flat header flanges Note: Raised bead headers must match embossment			9439	
5VZFE 4Runner, T100, Tundra, Tacoma		Seals all stock iron manifolds and flat header flanges Note: Raised bead headers must match embossment			9465	

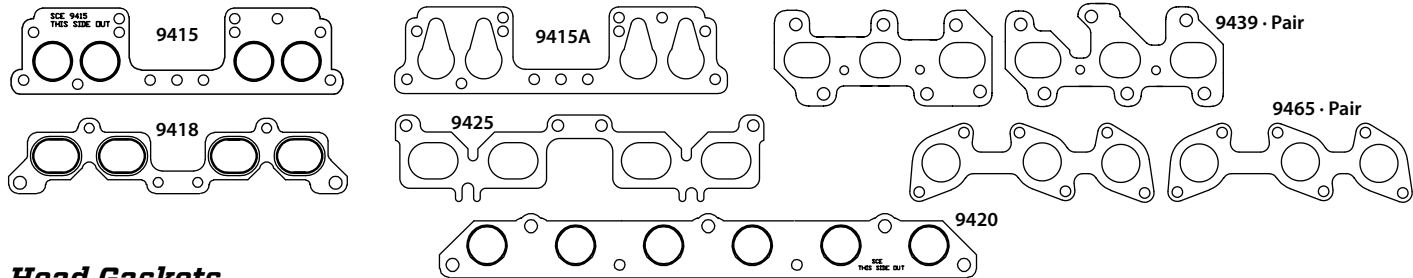

Head Gaskets

Copper Racing Head Gaskets for Toyota Engines

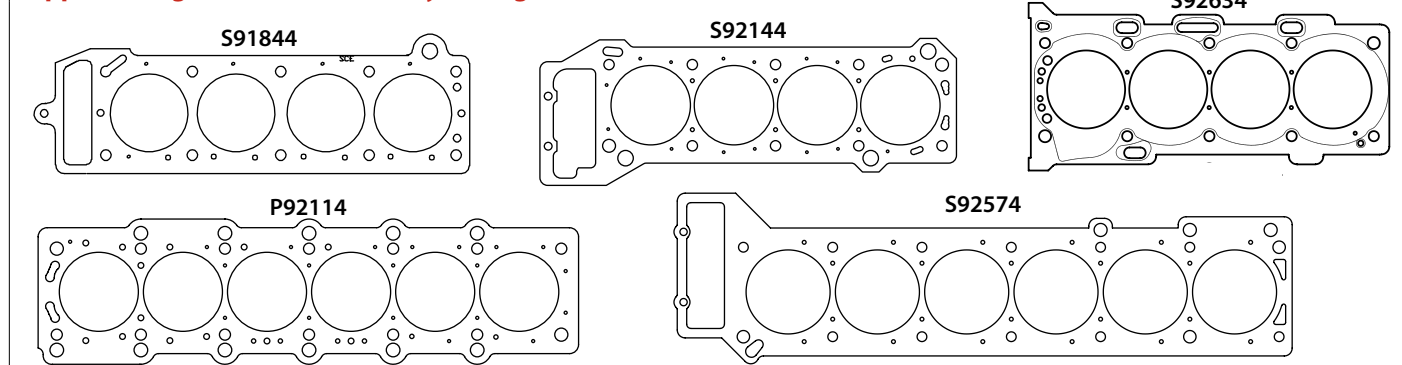

Engine Code Application	Bore	Thickness							
		.021"	.032"	.043"	.050"	.062"	.072"	.080"	.093"
20R 2.2L SOHC / 22R 2.4L SOHC	3.750" 95.25mm round	P91842	P91843	P91844	P91845	P91846	P91847	P91848	P91849
			T91843	T91844	T91845	T91846	T91847	T91848	T91849
				S91844	S91845	S91846	S91847	S91848	S91849
2AZFE 2.4L DOHC	3.500" 88.9mm round	P92632	P92633	P92634	P92635	P92636	P92637	P92638	P92639
			T92633	T92634	T92635	T92636	T92637	T92638	T92639
				S92634	S92635	S92636	S92637	S92638	S92639
2RZFE 2.4L / 3RZFE 2.7L	3.850" 97.8mm round	P92142	P92143	P92144	P92145	P92146	P92147	P92148	P92149
			T92143	T92144	T92145	T92146	T92147	T92148	T92149
				S92144	S92145	S92146	S92147	S92148	S92149
2JZ-GTE 3.0L Inline 6	3.437" 87.3mm round	P92112	P92113	P92114	P92115	P92116	P92117	P92118	P92119
1FZ-FE Landcruiser Inline 6	4.010" 101.9mm round	P92572	P92573	P92574	P92575	P92576	P92577	P92578	P92579
			T92573	T92574	T92575	T92576	T92577	T92578	T92579
				S92574	S92575	S92576	S92577	S92578	S92579

"P" Prefix: Pro Copper for use with o-rings & sealant • "T" Prefix: Titan sealed coolant passages, for use with o-rings
 "S" Prefix: ICS Titan sealed coolant passages, integral combustion o-ring • "P" Prefix supersedes "0" Prefix

Exhaust Gaskets

Fitment & Dimensions	Accu Seal E <i>Standard Material</i>	E Dyno Pak <i>Bulk Pak of 10 pr</i>	Accu Seal Pro <i>Premium Material</i>	Pro Dyno Pak <i>Bulk Pak of 10 pr</i>	Pro Copper Embossed <i>Raised Sealing Bead</i>	Pro Copper Annealed <i>Flat, Soft .062" Thick</i>
Air Cooled Flat 4 1.5" Round	<i>Fits Air Cooled Flat 4 engines with stock manifolds or headers, Set contains 4 pieces</i>				9406	
Air Cooled Flat 4 1.62" Round	<i>Fits Air Cooled Flat 4 engines with ported heads and large port headers, Set contains 4 pieces</i>				9407	
Small Collector 1.62" Round, 3 Bolts	<i>Fits manifold-to-muffler flange, air cooled engines</i>				9408	
Large Collector 2.4" Round, 3 Bolts	<i>Fits manifold to 'Stinger' and large tube muffler, air cooled engines</i>				9409	

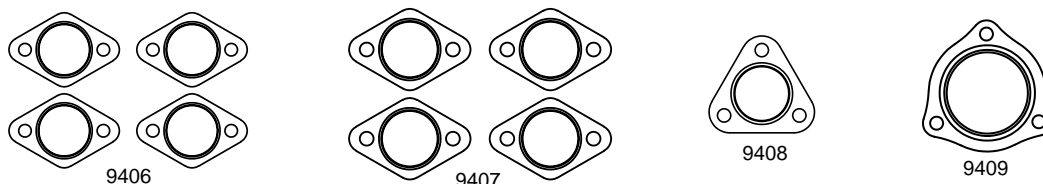
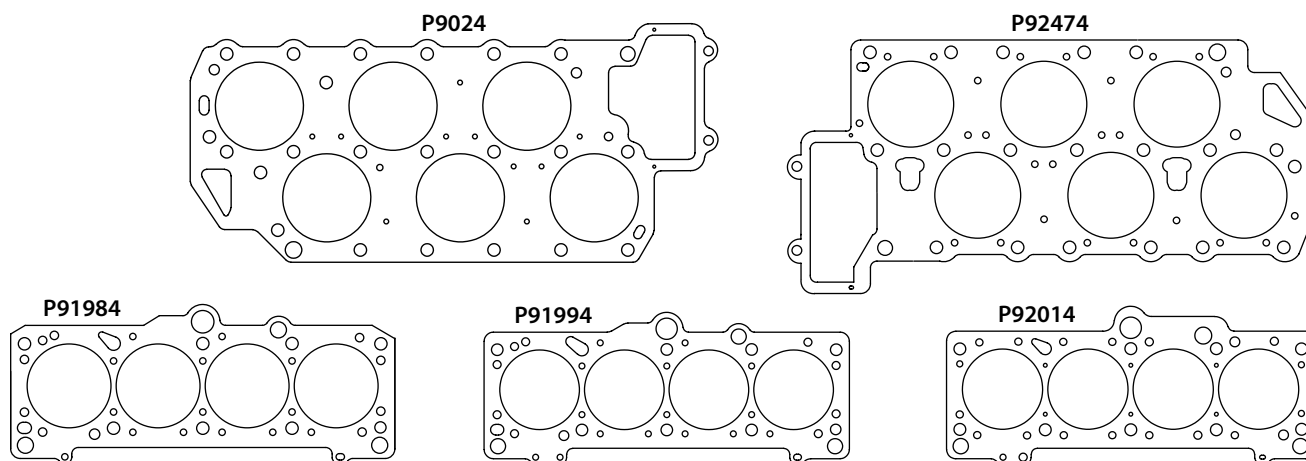
See fitment instructions on page 358

Head Gaskets
Copper Racing Head Gaskets for Volkswagen Engines

Engine Code Application	Bore	Thickness							
		.021"	.032"	.043"	.050"	.062"	.072"	.080"	.093"
1.8L SOHC 8V	3.305" 84mm round	P91982	P91983	P91984	P91985	P91986	P91987	P91988	P91989
1.8T DOHC 16V	3.305" 84mm round	P91992	P91993	P91994	P91995	P91996	P91997	P91998	P91999
2.0L SOHC 8V	3.260" 82.8mm	P92012	P92013	P92014	P92015	P92016	P92017	P92018	P92019
2002 & Earlier 2.8L VR6 12V	3.305" 84mm round		P92023	P92024	P92025	P92026	P92027	P92028	P92029
2003 & Later 2.8L VR6 24V	3.305" 84mm round		P92473	P92474	P92475	P92476	P92477	P92478	P92479

"P" Prefix: Pro Copper for use with o-rings & sealant • **"T" Prefix:** Titan sealed coolant passages, for use with o-rings
"S" Prefix: ICS Titan sealed coolant passages, integral combustion o-ring • **"P" Prefix** supersedes "O" Prefix

Collector & Turbo Flange Gaskets

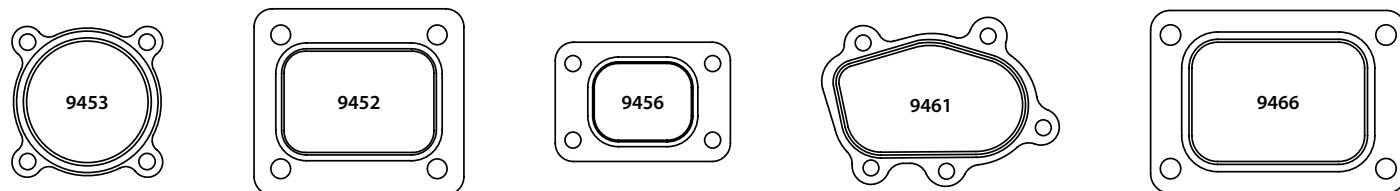
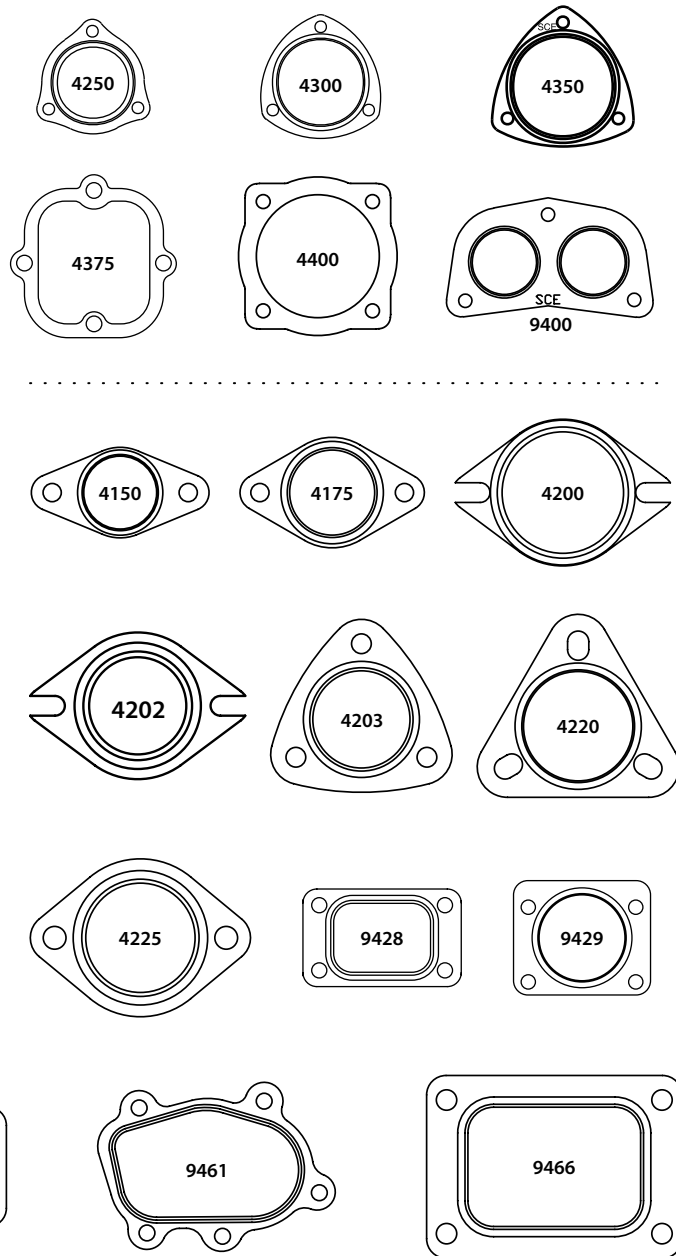
Description	Pro Copper Pkg Qty	Accu-Seal Pro Pkg Qty	Accu-Seal E Pkg Qty
1.5" Two Bolt Flange	4150 1 pc		
1.75" 2 Bolt Flange	4175 1 pc		
2.00" Two Bolt Flange	4202 1 pc		
2.00" Three Bolt Flange	4203 1 pc		
2.25" Two Bolt Flange	4225 1 pc		
2.25" Three Bolt Flange	4220 1 pc		
2.50" Two Bolt Flange	4200 1 pc		
2.50" Three Bolt Header Collector	4250 2 pc	576002 2 pc	575999 2 pc
3.0" Three Bolt Header Collector	4300 2 pc	512042 2 pc	512039 2 pc
3.5" Three Bolt Header Collector	4350 2 pc	512032 2 pc	512029 2 pc
3.75" Square Street Performance Brand Collector Gaskets	4375 2 pc	514377 2 pc	514375 2 pc
4.0" Four Bolt Collector Gaskets	4400 2 pc		
Three Bolt Two Port Import Collector/Down Pipe	9400 1 pc	516502 2 pc	516500 2 pc
T2 Flange Gasket	9456 1 pc		
T25/T28 Turbine Outlet Gasket	9461 1 pc		
T3 Round Flange Gasket	9429 1 pc		
T3 Symmetrical Flange Gasket	9453 1 pc		
T3/T4 Rectangle Flange Gasket	9428 1 pc		
T4 Flange Gasket	9452 1 pc		
90mm Turbo Flange Gasket	9466 1 pc		



ACCESSORIES

O-ring Wire & Sealants

Description	Part #
.041" 304 Stainless O-ring Wire: 15' roll for 10 cylinders	31541
.041" 304 O-ring Wire & Kit: 15' of wire, tool & instructions	31542
.041" 304 Stainless O-ring Wire: 1 Pound Spool	31543
.062" 304 Stainless O-ring Wire: 15' roll for 10 cylinders	31562
.062" 304 O-ring Wire & Kit: 15' of wire, tool & instructions	31563
Copper Coat 9oz Aerosol Head Gasket Sealant	G1612
High Temp Black Silicone 3.35 oz Tube	G1613
Gasgacinch Gasket Sealing Compound: 8oz Brush Top Can	G1614
Hi-Temp Automotive Grade Head Bolt Thread Sealant	G1615
Gasgacinch Gasket Sealing Compound: 16oz Brush Top Can	G1616

Precision Injection Molded Carb Gaskets for Holley Style Carburetors

Description	Part #	Pkg Qty
4150 Molded Metering Gaskets	410	2 pc
4150/4160 Molded Bowl Gaskets	411	2 pc
4150 Molded Carb Gasket Set	412	2 pair
4500 Molded Metering Gaskets	450	2 pc
4500 Molded Bowl Gaskets	451	2 pc
4500 Molded Carb Gasket Set	452	2 pair
4150 Metering Gasket Dyno-Pak	410-10	10 pc
4150/4160 Bowl Gasket Dyno-Pak	411-10	10 pc
4500 Metering Gasket Dyno-Pak	450-10	10 pc
4500 Bowl Gasket Dyno-Pak	451-10	10 pc

Technology Meets Carburetor Gaskets

- Jetting changes just got quicker & easier
- Super-tough molded gaskets
- Won't tear or stick
- Eliminates scraping
- Completely reusable

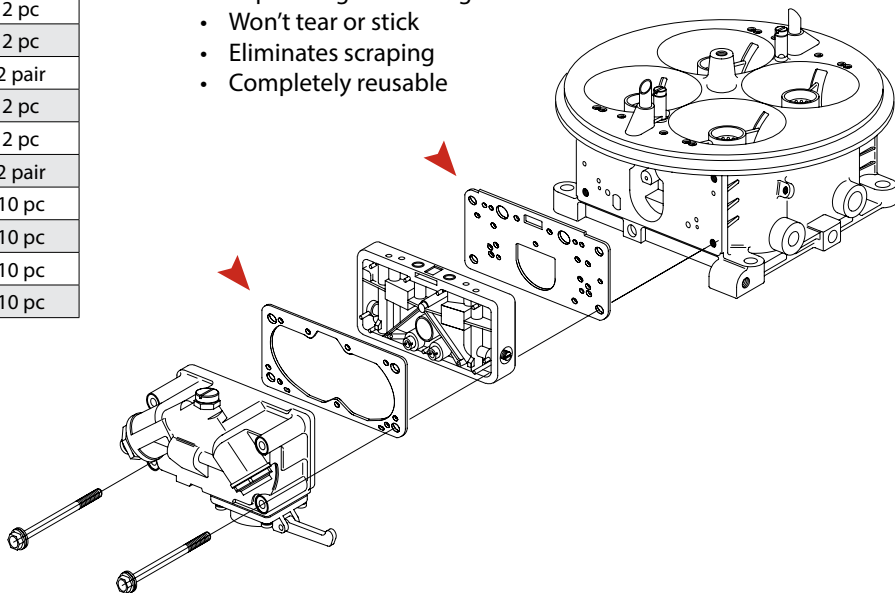

Standard Coated Gaskets for Holley Style Carburetors

Description	Part #	Pkg Qty
2300, 4150, 4160 Fuel Bowl	358	2 pc
4500 series Fuel Bowl	359	2 pc
2300, 4150, 4160 & 4500 2 Circuit Metering Block	370	2 pc
4160 & 4175 Vacuum Secondary Metering Block	361	2 pc
4500 Series 3 Circuit Metering Block	372	2 pc

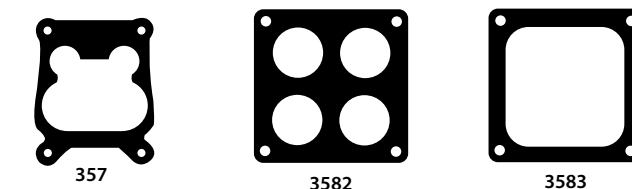
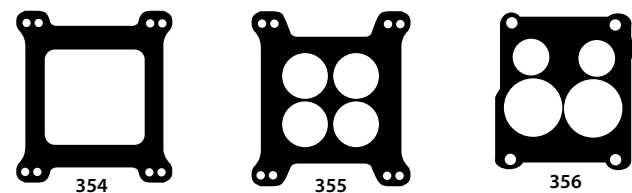
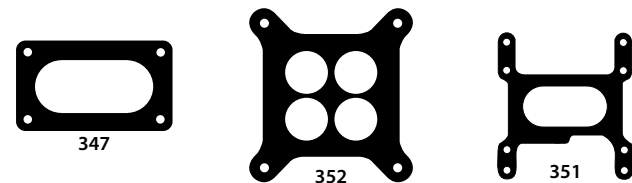
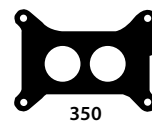
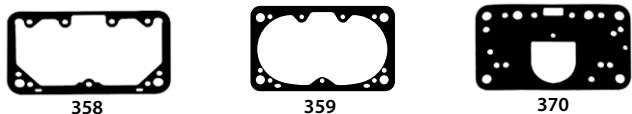

Carburetor Base Mounting Gaskets

Description	Part #	Pkg Qty
Split Dominator	347	10 pc
Holley 4 bbl Insulator Gasket (1.625" x .250")	352	1 pc
Holley 500 cfm 2 bbl	349	10 pc
Holley 350 cfm 2 bbl	350	10 pc
Holley 2 bbl NASCAR® Spec Restrictor Plate	351	10 pc
Holley 4 bbl Open	354	10 pc
Holley 4 bbl 4 Hole	355	10 pc
Rochester Quadrajets Spreadbore	356	10 pc
Rochester Quadrajets Insulator Gasket (.250" Thick)	357	1 pc
Holley Dominator 4 Hole	3582	10 pc
Holley Dominator Open	3583	10 pc
Holley Spreadbore	3584	10 pc

Other Fuel System Gaskets

Description	Part #	Pkg Qty
5" I.D. Air Cleaner Mounting Gasket	201	10 pc
Fuel Cell Vent Tube Gasket	205	1 pc
Fuel Cell Fill Neck Gasket	206	1 pc
24 Bolt Fuel Cell Fill Plate Gasket	207	1 pc

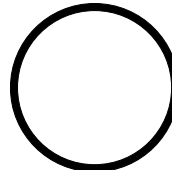

201

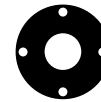

205

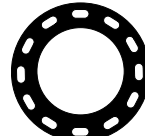

206

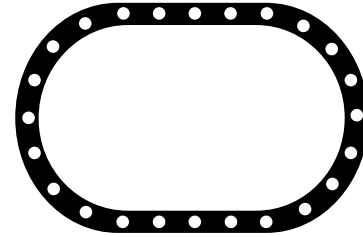

207

BLOWER GASKETS

Roots Type Blower Gaskets

Description	Part #
4-71 Base Gasket	329010
6-71 Base Gasket	329020
8-71 Base Gasket	329030
14-71 8 Bolt Base Gasket	329041
14-71 10 Bolt Base Gasket	329040
14-71 Kobelco Base Gasket	329042
14-71 SSI Base Gasket	329043
4-71 Inlet Gasket	329060
4-71 Screened Inlet Gasket	329080
6-71 / 8-71 Inlet Gasket	329100
6-71 / 8-71 Screened Inlet Gasket	329120
14-71 Inlet Gasket	329140
14-71 X-Large Inlet Gasket	329160
Front Cover Gasket	329200
Snout / Tri-plate Gasket	329300
Blower Manifold End Seals	26601

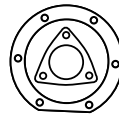

329300

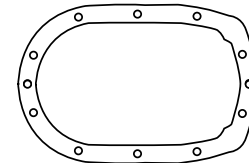

329200

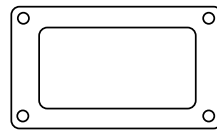

329060

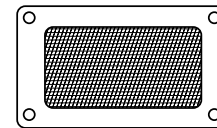

329080

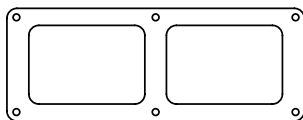

329100

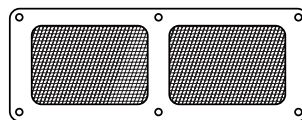

329120

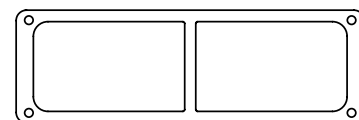

329140

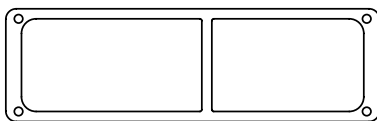

329160

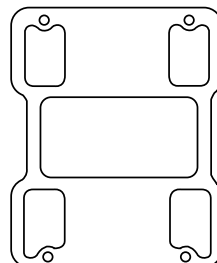

329010



26601

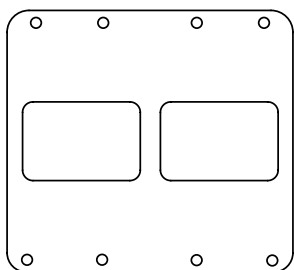

329020

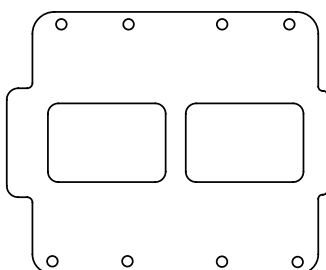

329030

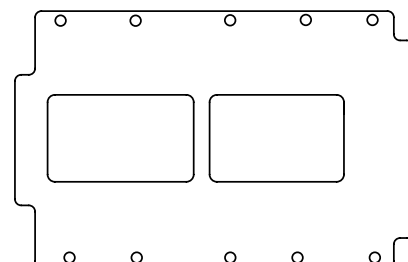

329040

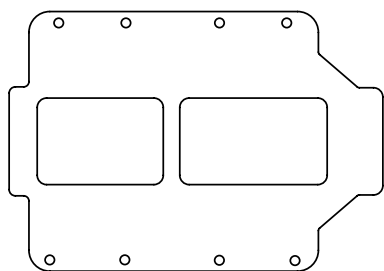

329041

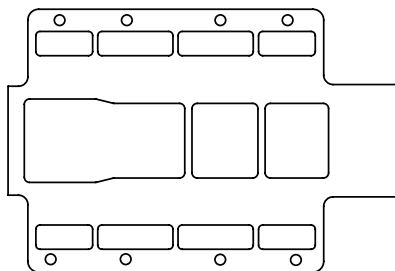

329042

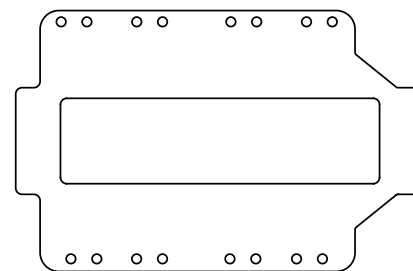

329043

DRIVE LINE GASKETS
Rear Axle Gaskets

Description	Accu Seal E Standard Material	Accu Seal Pro Re-usable Steel Core, Teflon® Coated
Quick Change Cover Gasket	103	203
Contoured Quick Change Gasket	104	204
Ford 9" Gearset Gasket	182	282
GM 10 Bolt Gasket (8.2" ring gear)	183	283
GM Car 12 Bolt Gasket (8.875" gear)	184	284
Dana 44 Gasket (8.5" ring gear)	185	285
Dana 60 Gasket (9.75" ring gear)	186	286

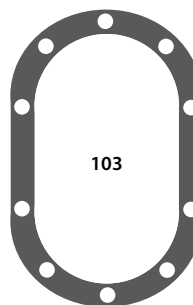

103

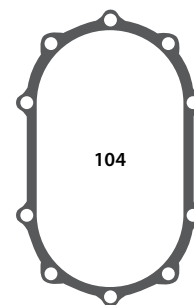

104

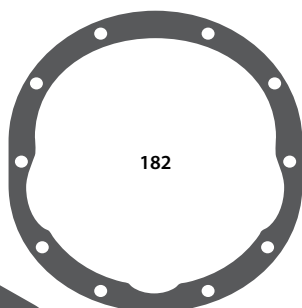

182

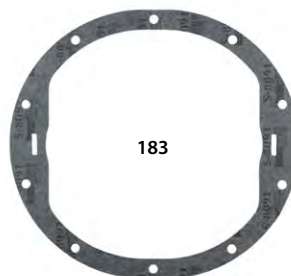

183

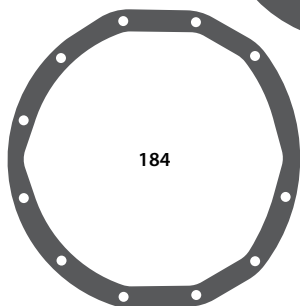

184



185

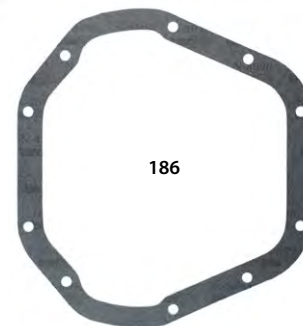

186



How to Use the Engine Master Section of this Catalog

Engines are listed as follows:

1. **Make**
 - a. *Cars*
 - b. *Trucks, Mini-vans, SUVs*
2. **Number of Cylinders**
3. **Engine Displacement**
4. **Year of Manufacture**

Example: The Ford 2.5L 153ci 4 cylinder engine is listed before the Ford 2.4L 144ci engine because the 2.5L has 4 cylinders. This is unique as competitive brand catalogs list by make then displacement without regard to the number of cylinders.

Handy Competitive Cross-Reference

As an aid to quick selection where applicable, SCE Gaskets has listed the nearest equivalent part number (less Alpha Prefix) of the Fel-Pro® Passenger Car & Light Truck set part number just below the SCE Engine Master Gasket Set part number.

Fel-Pro® is a registered trade name and is not in any way associated with these products. It is used as a cross reference only to help in part number selection.

HG 309-3 1965-1969 8180-2	HK 309-8 1965-1969 Rectangular Intake Man. Header Gaskets	HS 309-8 1965-1969 Rectangular Intake Man. Header Gaskets	KS 309-8 1965-1969 Rectangular Intake Man. Header Gaskets
HG 603-3 1968-1969 8171-1	HK 603-3 1968-1969 Valley Pan N/I 8171-4	HS 603-3 1968-1969 Valley Pan N/I 8171-4	KS 603-3 1968-1969 Valley Pan N/I 8171-4
HG 107-5	HK 107-5	HS 107-5	KS 107-5



Engine Master Gaskets · Engine Guide

American Motors 4 74

American Motors 6 76

American Motors V8 76

Chrysler, Dodge, Plymouth, & Eagle Cars: 4 Cyl 80

Chrysler, Dodge, Plymouth, & Eagle Cars: 6 Cyl 104

Chrysler, Dodge, Plymouth, & Eagle Cars: V8 112

Dodge Truck, Mini-vans, & SUVs: 4 Cyl 116

Dodge Truck, Mini-vans, & SUVs: 6 Cyl 128

Dodge Truck, Mini-vans, & SUVs: V8 134

Dodge Truck, Mini-vans, & SUVs: V10 140

Ford, Lincoln, Mercury Cars: 4 Cyl 142

Ford, Lincoln, Mercury Cars: 6 Cyl 156

Ford, Lincoln, Mercury Cars: V8 170

Ford Trucks, Mini-vans, & SUVs: 4 Cyl 188

Ford Trucks, Mini-vans, & SUVs: 6 Cyl 194

Ford Trucks, Mini-vans, & SUVs: V8 214

Ford Trucks, Mini-vans, & SUVs: V10 234

GM Buick, Cad, Chev, Geo, Olds, Pont, & Saturn: 3 Cyl 236

GM Buick, Cad, Chev, Geo, Olds, Pont, & Saturn: 4 Cyl 236

GM Buick, Cad, Chev, Geo, Olds, Pont, & Saturn: 6 Cyl 256

GM Buick, Cad, Chev, Geo, Olds, Pont, & Saturn: V8 278

GM Trucks, Mini-vans, & SUVs: 4 Cyl 304

GM Trucks, Mini-vans, & SUVs: 5 Cyl 310

GM Trucks, Mini-vans, & SUVs: 6 Cyl 310

GM Trucks, Mini-vans, & SUVs: V8 320

International (Navistar) Trucks: 6 Cyl 340

International (Navistar) Trucks: V8 340

Jeep: 4 Cyl 344

Jeep: 6 Cyl 346

Jeep: V8 350



ENGINE INFORMATION	HEAD GASKET	HEAD KIT With <u>NO</u> Valve Stem Seals	HEAD SET With Valve Stem Seals	KIT SET	SHORT BLOCK SET
--------------------	-------------	--	--------------------------------------	---------	-----------------

American Motors 4

1.4L 85.2 1397cc OHV L4 Renault C3J Engine 1983-87 VIN D 83-87 VIN E 83-85	HG 086-5 1983-1987 9114	HK 086-5 1983-1987 9114-1	HS 086-5 1983-1987 9114-1	KS 086-5 1983-1987 9114-1	ER 086-5 1983-1987 9114-1
1.7L 105.1 1721cc SOHC L4 Renault F3N Engine 1985-87 VIN A 1985-87	HG 081-6 1983-1987 9384	HK 081-6 1983-1987 9384-1	HS 081-6 1983-1987 9384-1	KS 081-6 1983-1987	ER 081-6 1983-1987
2.0L 120 1965cc SOHC L4 Renault F3R Engine 1987 VIN V 1987	HG 081-6 1987 9384	HK 081-6 1987 9384-1	HS 081-6 1987 9384-1	KS 081-6 1987 9384-1	ER 081-6 1987 9384-1
2.0L 121 1984cc SOHC L4 Audi Engine 1977-79 VIN G 1977-79 VIN K 1977	HG 087-0 1977-1979 8647	HK 087-0 1977-1979 8647	HS 087-0 1977-1979 8647	KS 087-0 1977-1979 8647	ER 087-0 1977-1979 8647
2.5L 150 OHV L4 Renault Engine 1983-88 VIN U 1983-88	HG 083-0 1983-1988 9196	HK 083-0 1983-1988 9196	HS 083-0 1983-85 9196 ----- HS 083-2 1986-88 9196-1/5	KS 083-0 1983-85 9196 ----- KS 083-2 1986-88 9196-1/5	ER 083-0 1983-85 9196
2.5L 151 OHV L4 Pontiac Crossflow Engine 1980-83 VIN B 1980-83	HG 312-5 1980-1983 9405-1	HK 312-5 1980-1983 8686-1	HS 312-5 1980-1983 8686-1	KS 312-5 1980-1983 8686-1	ER 312-5 1980-1983 8686-1



OIL PAN SET	INTAKE MANIFOLD SET	EXHAUST MANIFOLD SET	VALVE COVER SET	TIMING COVER SET	REAR SEAL SET	VALVE STEM SEAL SET
-------------	---------------------	----------------------	-----------------	------------------	---------------	---------------------

American Motors 4

OP 086-5 1983-1987 34302	MS 086-5 1983-1987 91869	USE MS	VS 086-5 1983-1987 26019	NA	RS 086-5 1983-1987 40252	SS 086-5 1983-1987 72608
OP 081-5 1983-1987 30550	MS 081-5 1983-1987 92931	USE MS	VS 081-5 1983-1987 50269	TCS 081-2 1983-1987 Cam Frt Seal 45942 ----- TCS 081-4 1983-1987 Cam Rear Seal 45943	RS 403-5 1983-1987 40427	SS 081-5 1983-1987 72657
OP 081-5 1987 30550	MS 081-5 1987 92931	USE MS	VS 081-5 1987 50269	TCS 081-2 1987 Cam Frt Seal 45942 ----- TCS 081-4 1987 Cam Rear Seal 45943	RS 403-5 1987 40427	SS 081-5 1987 72657
OP 087-0 1977-1979 30395-1	MS 087-0 1977-1979 22803	EMS 087-0 1977-1979 90416	VS 087-0 MS 086-5 1983-1987 91869	TCS 408-2 1977-1979 Cam Frt Seal 45357 TCS 087-0 Crk Frt Seal	RS 087-0 1983-1987 V JV510	SS 087-0 1983-1987 V B20169
OP 083-0 1983-1988 30476	MS 083-0 1983-1988 92100	USE MS	VS 083-0 1983-1988 50245	TCS 082-5 1983-1988 45117	RS 312-5 1983-1988 40578	SS 083-0 1984-85 72668 ----- SS 315-5 1986-88 70816
OP 312-5 1980-1983 30409	MS 312-5 1980-1983 90563	EMS 312-5 1980-1983 90564	VS 312-5 1980-1983 50179 ----- PS 312-5 Push Rod Cvr 1980-1983 50153	TCS 302-3 1980-1982 13198	RS 312-5 1980-1983 40578	SS 312-5 1980 5112 ----- SS 312-6 1981-1983 72531



ENGINE INFORMATION	HEAD GASKET	HEAD KIT With <u>NO</u> Valve Stem Seals	HEAD SET With Valve Stem Seals	KIT SET	SHORT BLOCK SET
--------------------	-------------	--	--------------------------------------	---------	-----------------

American Motors 6

3.3L 199 OHV L6 AMC Engine 1965-70 VIN A 1966-1970 VIN B 1970 VIN E 1966 VIN J 1965-1969 VIN P 1968-1969	HG 082-5 1965-1970 8169	HK 082-5 1965-1970 8169-2	HS 082-5 1965-1970 8169-2	KS 082-5 1965-1970 8169-4	ER 082-5 1965-1970 8169-4
3.8L 232 OHV L6 (High Torque) AMC Engine 1964-79 VIN B, C 1966-1969 VIN E 1967-1979 VIN F, G 1966-1971 VIN L 1964-1968 VIN M 1966-1967 & 1969 VIN P 1967-1969 VIN Q 1970-1970 VIN S 1965-1967 VIN T 1967 VIN V 1966 VIN W 1965	HG 082-5 1964-1979 8169	HK 082-5 1964-1979 8169-2	HS 082-5 1964-1979 8169-2	KS 082-5 1964-1979 8169-4	ER 082-5 1964-1979 8169-4
4.2L 258 OHV L6 AMC Engine 1971-88 VIN A 1971-1979 VIN B 1971 VIN C 1976-1988	HG 082-5 1971-1980 1986-1988 8169 ----- HG 082-6 1981-1985 8778	HK 082-5 1971-1980 1986-1988 8169-2 ----- HK 082-6 1981-1985 8778	HS 082-5 1971-1980 1986-1988 8169-2 ----- HS 082-6 1981-1985 8778	KS 082-5 1971-1980 1986-1988 8169-4 ----- KS 082-6 1981-1985 8778	ER 082-5 1971-1980 1986-1988 8169-4 ----- ER 082-6 1981-1985 8778

American Motors V8

4.7L 290 OHV V8 AMC Engine 1966-69 VIN C, D 1966-1967 VIN H 1966-1969 VIN M 1968-1969 VIN N 1966-1969 VIN U 1967	HG 084-5 1966-1979 8211-1	HK 084-5 1966-1979 Valley Pan N/I 8211-4	HS 084-5 1966-1979 Valley Pan N/I 8211-4	KS 084-5 1966-1979 Valley Pan N/I 8211-4	ER 084-5 1966-1979 Valley Pan N/I 8211-4
---	---------------------------------	---	---	---	---

OIL PAN SET	INTAKE MANIFOLD SET	EXHAUST MANIFOLD SET	VALVE COVER SET	TIMING COVER SET	REAR SEAL SET	VALVE STEM SEAL SET
-------------	---------------------	----------------------	-----------------	------------------	---------------	---------------------

American Motors 6

OP 082-5 1965-1970 13881-1	MS 082-5 1965-1970 9982	USE MS	VS 082-5 1965-1970 50186	TCS 082-5 1965-1970 45117	RS 082-5 1965-1970 40612	SS 082-5 1965-1970 70530
OP 082-5 1964-1979 13881-1 ----- OP 082-6 1971-1979 1 Pc Silicone 34308	MS 082-5 1964-1979 9982	USE MS	VS 082-5 1964-1979 50186	TCS 082-5 1964-1979 45117	RS 082-5 1964-1979 40612	SS 082-5 1964-1979 70530
OP 082-5 1971-1988 13881-1 ----- OP 082-6 1971-1988 1 Pc Silicone 34308	MS 082-5 1971-1980 9982 ----- MS 082-6 1981-1988 90949	USE MS	VS 082-5 1971-1980 50186 ----- VS 082-6 1981-1988 Plastic VC 50244	TCS 082-5 1971-1988 45117	RS 082-5 1971-1988 40612	SS 082-5 1971-1988 70530

American Motors V8

OP 085-0 1966-1979 30187	VP 085-5 1966-1979 96011	EMS 085-0 1966-1979 90164	VS 085-5 1966-1979 50001	TCS 085-0 1966-1979 45003	RS 085-5 1966-1979 40003	SS 084-5 1966-1979 12443
--------------------------------	--------------------------------	---------------------------------	--------------------------------	---------------------------------	--------------------------------	--------------------------------



ENGINE INFORMATION	HEAD GASKET	HEAD KIT With <u>NO</u> Valve Stem Seals	HEAD SET With Valve Stem Seals	KIT SET	SHORT BLOCK SET
--------------------	-------------	--	--------------------------------------	---------	-----------------

American Motors V8

5.0L 304 OHV V8 AMC Engine 1970-79 VIN H 1970-1979 VIN I 1970-1971 VIN M 1971-1974	HG 084-5 1970-1979 8211-1	HK 084-5 1970-1979 Valley Pan N/I 8211-4	HS 084-5 1970-1979 Valley Pan N/I 8211-4	KS 084-5 1970-1979 Valley Pan N/I 8211-4	ER 084-5 1970-1979 Valley Pan N/I 8211-4
5.6L 343 OHV V8 AMC Engine 1967-69 VIN J, K, Q, R V, W 1967 VIN S, T, 1968-1969 VIN X, Z 1967-1969	HG 085-5 1967-1969 8266-1	HK 085-5 1967-1969 Valley Pan N/I 8266-4	HS 085-5 1967-1969 Valley Pan N/I 8266-4	KS 085-5 1967-1969 Valley Pan N/I 8266-4	ER 085-5 1967-1969 Valley Pan N/I 8266-4
5.9L 360 OHV V8 AMC Engine 1970-78 VIN H 1971 VIN N 1970-1978 VIN P 1970-1976	HG 085-5 1970-1978 8266-1	HK 085-5 1970-1978 Valley Pan N/I 8266-4	HS 085-5 1970-1978 Valley Pan N/I 8266-4	KS 085-5 1970-1978 Valley Pan N/I 8266-4	ER 085-5 1970-1978 Valley Pan N/I 8266-4
6.4L 390 OHV V8 AMC Engine 1968-70 VIN W 1968-1969 VIN X 1968-1970 VIN Y 1970	HG 085-5 1968-1970 8266-1	HK 085-5 1968-1970 Valley Pan N/I 8266-4	HS 085-5 1968-1970 Valley Pan N/I 8266-4	KS 085-5 1968-1970 Valley Pan N/I 8266-4	ER 085-5 1968-1970 Valley Pan N/I 8266-4
6.6L 401 OHV V8 AMC Engine 1971-76 VIN Z 1971-1976	HG 085-5 1971-76 8266-1	HK 085-5 1971-76 Valley Pan N/I 8266-4	HS 085-5 1971-76 Valley Pan N/ 18266-4	KS 085-5 1971-76 Valley Pan N/I 8266-4	ER 085-5 1971-76 Valley Pan N/I 8266-4

OIL PAN SET	INTAKE MANIFOLD SET	EXHAUST MANIFOLD SET	VALVE COVER SET	TIMING COVER SET	REAR SEAL SET	VALVE STEM SEAL SET
-------------	---------------------	----------------------	-----------------	------------------	---------------	---------------------

American Motors V8

OP 085-0 1970-1979 30187	VP 085-5 1970-1979 96011	EMS 085-5 1970-1979 90166	VS 085-5 1970-1979 50001	TCS 085-0 1970-1979 45003	RS 085-5 1970-1979 40003	SS 084-5 1970-72 12443 ----- SS 085-5 1973-79 70529
OP 085-0 1967-1969 30187	VP 085-5 1967-1969 96011	EMS 085-0 1967-1969 90164	VS 085-5 1967-1969 50001	TCS 085-0 1967-1969 45003	RS 085-5 1967-1969 40003	SS 084-5 1967-1969 12443
OP 085-0 1970-1978 30187	VP 085-5 1970-1978 96011	EMS 085-5 1970-1978 90166	VS 085-5 1970-1978 50001	TCS 085-0 1970-1978 45003	RS 085-5 1970-1978 40003	SS 084-5 1970-72 12443 ----- SS 085-5 1973-78 70529
OP 085-0 1968-1970 30187	VP 085-5 1968-1970 96011	EMS 085-0 1968-69 90164 ----- EMS 085-5 1970 90166	VS 085-5 1968-1970 50001	TCS 085-0 1968-1970 45003	RS 085-5 1968-1970 40003	SS 084-5 1968-1970 12443
OP 085-0 1971-76 30187	VP 085-5 1971-76 96011	EMS 085-5 1971-76 90166	VS 085-5 1971-76 50001	TCS 085-0 1971-76 45003	RS 085-5 1971-76 40003	SS 084-5 1971-72 12443 ----- SS 085-5 1973-76 70529



ENGINE INFORMATION	HEAD GASKET	HEAD KIT With <u>NO</u> Valve Stem Seals	HEAD SET With Valve Stem Seals	KIT SET	SHORT BLOCK SET
--------------------	-------------	--	--------------------------------------	---------	-----------------

Chrysler, Dodge, Plymouth, & Eagle Cars: 4 Cyl

1.4L 86 1410cc SOHC L4 Mitsubishi G12B Engine, 8 Vlv 1979-84 VIN A 1984 VIN J 1979-80 VIN 2 1981-83	HG 943-5 1979-84 9352	HK 943-5 1979-84 9352	HS 943-5 1979-84 9352	KS 943-5 1979-84 9352	ER 943-5 1979-84 9352
1.5L 89.5 1468cc SOHC L4 Mitsubishi G15B/4G15 Engine, 12 Vlv 1985-90 Q ENG. 2 Bbl. Carb 1985-1992 Fuel Inj. 1987-1990 1991-96 Fuel Inj. Eng. 1991-1996	HG 943-5 1985-1992 2 Bbl. 1987-1990 Fuel Inj. Eng 9352 ----- HG 943-6 1991-1996 Fuel Inj. Eng. 9758	HK 943-5 1985-1992 2 Bbl. 1987-1990 Fuel Inj. Eng 9352 ----- HK 943-6 1991-1996 Fuel Inj. Eng. 9758	HS 943-5 1985-1992 2 Bbl. 1987-1990 Fuel Inj. Eng 9352 ----- HS 943-6 1991-1996 Fuel Inj. Eng. 9758	KS 943-5 1985-1992 2 Bbl. 1987-1990 Fuel Inj. Eng 9352 ----- KS 943-6 1991-1996 Fuel Inj. Eng. 9758	ER 943-5 1985-1992 2 Bbl. 1987-1990 Fuel Inj. Eng 9352 ----- ER 943-6 1991-1996 Fuel Inj. Eng. 9758
1.6L 97.1 1592cc OHV L4 Peugeot E82 Engine , 8 Vlv 1983-86 VIN A 1983-1986	HG 944-3 1983-1986 9119	HK 944-3 1983-1986 9119	HS 944-3 1983-1986 9119	KS 944-3 1983-1986 9119	ER 944-3 1983-1986 9119
1.6L 97.3 1595cc DOHC L4 Mitsubishi 4G61 Engine, 16 Vlv 1989-90 VIN Y 1989-1990	HG 908-5 1989-1990 9627	HK 908-5 1989-1990 9627	HS 908-5 1989-1990 9627	KS 908-5 1989-1990 9627	ER 908-5 1989-1990 9627

OIL PAN SET	INTAKE MANIFOLD SET	EXHAUST MANIFOLD SET	VALVE COVER SET	TIMING COVER SET	REAR SEAL SET	VALVE STEM SEAL SET
-------------	---------------------	----------------------	-----------------	------------------	---------------	---------------------

Chrysler, Dodge, Plymouth, & Eagle Cars: 4 Cyl

OP 943-5 1979-1984 30414	MS 943-5 1979-1984 90968	EMS 943-5 1979-1984 90967	VS 943-5 1979-1984 50195	TCS 943-3 1979-1984 Cam Frt Seal 45483 TCS 934-5 1979-1984 Crk Frt Seal 45482-1	RS 943-5 1979-1984 40097-1	SS 943-5 1979-1984 72524 ----- SS 407-6 1979-1984 Auxiliary 72681
OP 943-5 1985-1996 30414	MS 943-5 1985-1992 90968 ----- MS 943-6 1991-1996 94789	EMS 943-5 1985-1992 90967 ----- EMS 943-6 1991-1996 94789	VS 943-5 1985-1991 2 Bbl Carb. 50195 ----- VS 943-6 1991-1996 Fuel Inj. 50382	TCS 943-3 1985-1996 Cam Frt Seal 45483 ----- TCS 934-5 1985-1996 Crk Frt Seal 45482-1 ----- TCS 943-6 1995-1996 Crk Frt Seal 46027	RS 943-5 1985-1994 Radial 40097-1 ----- RS 943-6 1995-1996 Radial 40672	SS 943-5 1985-1991 2 Bbl 1987-1990 Fuel Inj. 72524 ----- SS 407-6 1985-1996 Auxiliary 72681 ----- SS 943-8 1991-1996 Fuel Inj. 72805
OP 944-3 1983-1986 Upper 30919 ----- OP 944-4 1983-1986 Lower 30465	MS 944-3 1983-1986 91865	EMS 944-3 1983-1986 91864	VS 944-3 1983-1986 50237	TCS N/A	RS 944-3 1983-1986 40418	SS 403-5 1983-1986 72567
OP 952-5 1989-1990 30460	MS 908-5 1989-1990 94328	EMS 958-5 1989-1990 95470	VS 908-6 1989-1990 50041	TCS 943-5 1989-1990 Cam Frt Seal 45483 ----- TCS 952-8 1989-1990 Crk Frt Seal 45915	RS 407-5 1989-1990 40408-1	SS 908-4 1989-1990 70359



ENGINE INFORMATION	HEAD GASKET	HEAD KIT With <u>NO</u> Valve Stem Seals	HEAD SET With Valve Stem Seals	KIT SET	SHORT BLOCK SET
--------------------	-------------	--	--------------------------------------	---------	-----------------

Chrysler, Dodge, Plymouth, & Eagle Cars: 4 Cyl

<p>1.6L 97.3 1595cc DOHC Turbo L4 Mitsubishi 4G61-T Engine, 16 Vlv 1989-90</p> <p>VIN Z 1989-1990</p>	<p>HG 908-5 1989-1990 9627</p>	<p>HK 908-5 1989-1990 9627</p>	<p>HS 908-5 1989-1990 9627</p>	<p>KS 908-5 1989-1990 9627</p>	<p>ER 908-5 1989-1990 9627</p>
<p>1.6L 97.5 1597cc SOHC L4 Mitsubishi G32B/4G32 Engine, 8 Vlv 1971-84</p> <p>VIN B 1984 VIN K 1971-90 VIN Z 1977-1980 VIN 3 1981-1983</p>	<p>HG 402-5 1971-1977 8529 ----- HG 942-5 1977-1980 Round Cooling Holes 8644</p>	<p>HK 402-5 1971-1977 8529 ----- HK 942-5 1977-1980 Vin Z 1978-1980 Vin K 8644-1 ----- HK 942-6 1981-1982 VIN K To 3-1-82 Canada EMS N/I 8644-2</p>	<p>HS 402-5 1971-1977 8529 ----- HS 942-5 1977-1980 Vin Z 1978-1980 Vin K 8644-1 ----- HS 942-6 1981-1982 VIN K To 3-1-82 Canada EMS N/I 8644-2</p>	<p>KS 402-5 1971-1977 8529 ----- KS 942-5 1977-1980 Vin Z 1978-1980 Vin K 8644-1 ----- KS 942-6 1981-1982 VIN K To 3-1-82 Canada EMS N/I 8644-2</p>	<p>ER 402-5 1971-1977 8529 ----- ER 942-5 1977-1980 Vin Z 1978-1980 Vin K 8644-1 ----- ER 942-6 1981-1982 VIN K To 3-1-82 Canada EMS N/I 8644-2</p>
<p>1.6L 97.5 1597cc SOHC Turbo L4 Mitsubishi G32B-T Engine, 8 Vlv 1984-90</p> <p>VIN Z 1984-1990</p>	<p>HG 945-3 1984-1990 Triangular Cooling Holes 8974</p>	<p>HK 945-3 1984-1990 8974-4</p>	<p>HS 945-3 1984-1990 8974-4</p>	<p>KS 945-3 1984-1990 8974</p>	<p>ER 945-3 1984-1990 8974</p>



OIL PAN SET	INTAKE MANIFOLD SET	EXHAUST MANIFOLD SET	VALVE COVER SET	TIMING COVER SET	REAR SEAL SET	VALVE STEM SEAL SET
-------------	---------------------	----------------------	-----------------	------------------	---------------	---------------------

Chrysler, Dodge, Plymouth, & Eagle Cars: 4 Cyl

<p>OP 952-5 1989-1990 30460</p>	<p>MS 908-5 1989-1990 94328</p>	<p>EMS 958-5 1989-1990 95470</p>	<p>VS 908-6 1989-1990 50041</p>	<p>TCS 952-5 1989-1990 Cam Frt Seal 45483 ----- TCS 952-6 1989-1990 Crank Frt Seal Use w/OP 45915</p>	<p>RS 407-5 1989-1990 40408-1</p>	<p>SS 908-4 1989-1990 70359</p>
<p>OP 402-5 1971-1977 30352 ----- OP 942-5 1977-1980 VIN Z 1978-1984 VIN K 30397</p>	<p>MS 942-5 1971-1984 K & Z 90410</p>	<p>EMS 402-5 1975-80 VIN K, Z 90992 ----- EMS 942-5 1981-1982 VIN K U.S. 1982-1984 VIN K w/ A/T 91057 ----- EMS 942-6 1982-1984 VIN K Manual Trans 92341</p>	<p>VS 402-5 1971-1977 w/Grommets & Semi-Circular Plug 50106 ----- VS 942-5 1977-1980 VIN Z 1978-1980 VIN K w/Grommets & Semi-Circular Plug 50104 ----- VS 945-0 1981-1984 VIN K w/Grommets & Semi-Circular Plug 50103</p>	<p>TCS 402-5 1971-1977 VIN K Crk Frt Seal 45095 ----- TCS 943-3 1977-1980 Cam Frt Seal VIN Z w/Balance Shaft 1978-1984 VIN B, K, 3 45483 ----- TCS 945-2 1981-1984 VIN B, 3 Crk Frt Seal Set 45497</p>	<p>RS 943-5 1984-1990 Radial 40097-1</p>	<p>SS 402-5 1971-1983 VIN K, Z 70702 ----- SS 403-6 1984 72630</p>
<p>OP 942-5 1984-1990 30397</p>	<p>MS 942-7 1984-1990 92339</p>	<p>EMS 945-0 1984-1990 92341</p>	<p>VS 945-0 1984-1990 w/Grommets & Semi-Circular Plug 50103</p>	<p>TCS 952-5 1984-1990 Cam Frt Seal 45483 ----- TCS 945-2 1984-1990 Crk Frt Seal 45497</p>	<p>RS 943-5 1984-1990 Radial 40097-1</p>	<p>SS 403-6 1984 To 8-1-84 72630 ----- SS 402-5 1984-1990 From 8-1-84 70702 ----- SS 407-6 1984-1990 Auxiliary 72681</p>



ENGINE INFORMATION	HEAD GASKET	HEAD KIT With <u>NO</u> Valve Stem Seals	HEAD SET With Valve Stem Seals	KIT SET	SHORT BLOCK SET
--------------------	-------------	--	--------------------------------------	---------	-----------------

Chrysler, Dodge, Plymouth, & Eagle Cars: 4 Cyl

<p>1.7L 105 1715cc SOHC L4 Audi Engine, 8 Valve (L/T 1982-83) 1978-83</p> <p>VIN A 1978-1983 VIN B 1983</p>	<p>HG 403-5 1978-1983 21200-1</p>	<p>HK 403-5 1978-1983 21200-3</p>	<p>HS 403-5 1978-1983 21200-3</p>	<p>KS 403-5 1978-1983 21200-3</p>	<p>ER 403-5 1978-1983 21200-3</p>
<p>1.8L 107.1 1755cc SOHC L4 Mitsubishi 4G37 Engine, 8 Vlv 1989-94</p> <p>VIN B 1993-1994 VIN T 1989-1992</p>	<p>HG 951-5 1989-1994 9846</p>	<p>HK 951-5 1989-1994 9846</p>	<p>HS 951-5 1989-1994 9846</p>	<p>KS 951-5 1989-1994 9846</p>	<p>ER 951-5 1989-1994 9846</p>
<p>1.8L 111.8 1834cc SOHC L4 Mitsubishi 4G93 Engine, 16 Vlv 1992-96</p> <p>VIN C 1992-1996 VIN D 1992</p>	<p>HG 910-5 1992-1996 9887</p>	<p>HK 910-2 1992-1996 9887</p>	<p>HS 910-2 1992-1996 9887</p>	<p>KS 910-2 1992-1996 9887</p>	<p>ER 910-2 1992-1996 9887</p>
<p>2.0L 121.7 1925cc SOHC L4 Mitsubishi G52B Engine, 8 Vlv 1974-79</p> <p>VIN U 1974-1979</p>	<p>HG 409-2 1974-1975 8771 ----- HG 409-4 1976-1979 8649</p>	<p>HK 409-2 1974-1975 8771-2 ----- HK 409-4 1976-1977 8649 ----- HK 409-5 1978-1979 8649-1</p>	<p>HS 409-2 1974-1975 8771-2 ----- HS 409-4 1976-1977 8649 ----- HS 409-5 1978-1979 8649-1</p>	<p>KS 409-2 1974-1975 8771-2 ----- KS 409-4 1976-1977 8649 ----- KS 409-5 1978-1979 8649-1</p>	<p>ER 409-2 1974-1975 8771-2 ----- ER 409-4 1976-1977 8649 ----- ER 409-5 1978-1979 8649-1</p>

OIL PAN SET	INTAKE MANIFOLD SET	EXHAUST MANIFOLD SET	VALVE COVER SET	TIMING COVER SET	REAR SEAL SET	VALVE STEM SEAL SET
-------------	---------------------	----------------------	-----------------	------------------	---------------	---------------------

Chrysler, Dodge, Plymouth, & Eagle Cars: 4 Cyl

OP 403-5 1978-1983 20101	MS 403-5 1978-1983 90403	USE MS	VS 403-1 1978 to Early '81 w/6 mm Stud w/ Plug 50119 ----- VS 403-5 Late 1981 to '83 w/6 mm Shoulder Stud w/Plug 50107	TCS 403-5 1978-1983 CamFrt Seal Set 45357 ----- TCS 403-6 1978-1983 Crk Frt Seal Set 24551 ----- TCS 403-3 1978-1983 Auxiliary 45288	RS 403-5 1978-1983 Radial 40427	SS 403-6 1978-1983 72567
OP 951-5 1989-1994 30397	MS 951-5 1989-1994 94630	EMS 951-5 1989-1994 94631	VS 945-0 1989-1994 w/Grommets & Semi-Circular Plug 50103	TCS 943-3 1989-1994 Cam Frt Seal Set 45483 ----- TCS 945-2 1989-1994 Crk Frt Seal Set Use w/OP 45910	RS 943-5 1989-1994 Radial 40097-1	SS 407-5 1989-1994 70598
OP 910-5 1992-1996 30655	MS 910-5 1992-1996 95313	EMS 910-5 1992-1996 95314	VS 910-5 1992-1996 w/Spark Plug Seals 50415	TCS 943-3 1992-1996 Cam Frt Seal Set 45483 ----- TCS 910-5 1992-1996 Crk Frt Seal Set 45931	RS 910-5 1992-1996 Radial 40648	SS 910-5 1992-1996 70660
OP 409-2 1974-1975 ----- OP 407-5 1976-1979 30400	MS 407-2 1974-1979 22811	EMS 409-2 1974-1975 ----- EMS 409-4 1978-1979 22812	VS 409-2 1974-1975 w/Grommets & Semi-Circular Plug 50356 ----- VS 407-5 1976-1979 w/Grommets & Semi-Circular Plug 50139	TCS 409-2 1974-1975 ----- TCS 407-5 1976-1979 Crk Frt Seal Set 45170	RS 407-5 1974-1979 Radial 40408-1	SS 402-5 1974-1979 70702 ----- SS 407-6 1974-1979 Auxiliary 72681



ENGINE INFORMATION	HEAD GASKET	HEAD KIT With <u>NO</u> Valve Stem Seals	HEAD SET With Valve Stem Seals	KIT SET	SHORT BLOCK SET
--------------------	-------------	--	--------------------------------------	---------	-----------------

Chrysler, Dodge, Plymouth, & Eagle Cars: 4 Cyl

<p>2.0L 122 1996cc SOHC L4 Chrysler Engine, 16 Vlv</p> <p>1995-2005</p> <p>VIN C 1995-2006 VIN F 2001-2005 H.O.</p>	<p>HG 411-2 1995 9036 ----- HG 411-4 1996-2005 26500</p> <p>Head Bolts HB 414-5 1995-2005 72157</p>	<p>HK 411-2 1995 Plastic Intake Gasket N/I 9036 ----- HK 411-4 1996-1999 Plastic Intake Gasket N/I 9036-1 ----- HK 411-6 2000 2001-2005 VIN C 9036-2 ----- HK 411-8 2001-2005 VIN F 9036-3</p>	<p>HS 411-2 1995 Plastic Intake Gasket N/I 9036-1 ----- HS 411-4 1996-1999 Plastic Intake Gasket N/I 9036-1 ----- HS 411-6 2000 2001-2005 VIN C 9036-2 ----- HK 411-8 2001-2005 VIN F 9036-3</p>	<p>KS 411-2 1995 Plastic Intake Gasket N/I 9036-1----- KS 411-4 1996-1999 Plastic Intake Gasket N/I 9036-19 ----- KS 411-6 2000 2001-2005 VIN C 9036-2 ----- HK 411-8 2001-2005 VIN F 9036-3</p>	<p>ER 411-2 1995 Plastic Intake Gasket N/I 9036-1 ----- ER 411-4 1996-1999 Plastic Intake Gasket N/I 9036-19 ----- ER 411-6 2000 2001-2005 VIN C 9036-2 ----- HK 411-8 2001-2005 VIN F 9036-3</p>
<p>2.0L 122 DOHC L4 Chrysler A588 Engine, 16 Vlv 1995-04</p> <p>VIN B 1995-1999 VIN Y 1995-1999, 2002-2004</p>	<p>HG 414-2 1995-1999 9922 ----- HG 414-4 .010 Thicker 1995-1999 26501 ----- HG 428-6 2002-2004 26206 ----- Head Bolts HB 414-6 1995-2004 72166</p>	<p>HK 414-4 1995-1999 9922 ----- HK 428-6 2002-2004 26206</p>	<p>HS 414-4 1995-1999 9922 ----- HS 428-6 2002-2004 26206</p>	<p>KS 414-4 1995-1999 9922 ----- KS 428-6 2002-2004 26206</p>	<p>ER 414-4 1995-1999 9922 ----- ER 428-6 2002-2004 26206</p>



OIL PAN SET	INTAKE MANIFOLD SET	EXHAUST MANIFOLD SET	VALVE COVER SET	TIMING COVER SET	REAR SEAL SET	VALVE STEM SEAL SET
-------------	---------------------	----------------------	-----------------	------------------	---------------	---------------------

Chrysler, Dodge, Plymouth, & Eagle Cars: 4 Cyl

<p>OP 414-5 1995-2005 30673</p>	<p>MS 411-4 1995-1996 Aluminum Intake 90708 ----- MS 411-5 1995-2000 Plastic Intake 2001-2005 VIN C 95695 ----- MS 411-6 2001-2005 VIN F 96163</p>	<p>EMS 411-4 1995-2005 VIN C 95674 ----- EMS 411-5 2001-2005 VIN F 96172</p>	<p>VS 411-2 1995 w/Grommets & Spark Plug Seals 50456 ----- VS 411-4 1996-1999 w/Grommets & Spark Plug Seals 50457 ----- VS 411-5 2000-2005 w/Grommets & Spark Plug Seals 50507</p>	<p>TCS 411-4 1995-2005 Cam Frt Seal Set 45961 ----- TCS 411-5 1995-2005 Crk Frt Seal Set 45962</p>	<p>RS 411-5 1995-2005 Radial 40182 ----- RS 408-8 1995-2005 Radial PTFE 40627</p>	<p>SS 414-5 1995-2005 72871</p>
<p>OP 414-5 1995-2004 30673</p>	<p>MS 414-1 1995-1999 Exc. Neon 95660-1 ----- MS 414-2 1995-1999 Neon 95660-2 ----- MS 428-6 2002-2004 92888</p>	<p>EMS 428-2 1995-1999 95692 ----- EMS 428-4 2002-2004 92846</p>	<p>VS 414-5 1995-1999 w/Spark Plug Seals 50455 ----- VS 414-6 2002-2004 w/Spark Plug Seals 50459 ----- Spark Plug Seals SPS-411-5 1995-1999 4 Pcs Per Pkg</p>	<p>TCS 411-4 1995-2004 Cam Frt Seal Set 2 Required 45961 ----- TCS 411-5 1995-2004 Crk Frt Seal Set 45962</p>	<p>RS 411-5 1995-1999 Radial Rubber 40182 ----- RS 408-8 1995-2004 Radial PTFE 40627</p>	<p>SS 414-5 1995-2004 72871</p>



ENGINE INFORMATION	HEAD GASKET	HEAD KIT With <u>NO</u> Valve Stem Seals	HEAD SET With Valve Stem Seals	KIT SET	SHORT BLOCK SET
--------------------	-------------	--	--------------------------------------	---------	-----------------

Chrysler, Dodge, Plymouth, & Eagle Cars: 4 Cyl

2.0L 122 1997cc SOHC L4 "A" Mitsubishi G63B/4G63 Engine, 8 Vlv 1984-92 VIN D 1984-1988 VIN V 1989-1992	HG 952-5 1984-1992 9086	HK 952-5 1984-1992 9086-1	HS 952-5 1984-1992 9086-1	KS 952-5 1984-1992 9086-1	ER 952-5 1984-1992 9086-1
2.0L 122 1997cc DOHC L4 Mitsubishi 4G63 Engine, 16 Vlv 1989-94 VIN E 1993-1994 VIN R 1989-1993	HG 908-5 1989-1994 9627	HK 908-5 1989-1992 9627 ----- HK 908-6 1993-1994 9627-1	HS 908-5 1989-1992 9627 ----- HS 908-6 1993-1994 9627-1	KS 908-5 1989-1992 9627 ----- KS 908-6 1993-1994 9627-1	ER 908-5 1989-1992 9627 ----- ER 908-6 1993-1994 9627-1
2.0L 122 1997cc SOHC L4 Mitsubishi 4G63 Engine, 16 Vlv 1993 VIN D 1993 VIN V 1993	HG 906-5 1993 9932	HK 906-5 1993 9932	HS 906-5 1993 9932	KS 906-5 1993 9932	ER 906-5 1993 9932

OIL PAN SET	INTAKE MANIFOLD SET	EXHAUST MANIFOLD SET	VALVE COVER SET	TIMING COVER SET	REAR SEAL SET	VALVE STEM SEAL SET
-------------	---------------------	----------------------	-----------------	------------------	---------------	---------------------

Chrysler, Dodge, Plymouth, & Eagle Cars: 4 Cyl

OP 952-5 1984-1992 30460 ----- MS 952-6 1986-1988 From 10-31-86 Upper Set 93695 ----- MS 952-8 1989-1992 Upper Set 94275	MS 952-5 1984-1992 Lower Set 91657 ----- MS 952-6 1986-1988 From 10-31-86 Upper Set 93695 ----- MS 952-8 1989-1992 Upper Set 94275	EMS 952-5 1984-1992 92029	VS 908-5 1984-1992 w/Grommets & Semi-Circular Plug 50132	TCS 952-5 1984-1992 Cam Frt Seal Set 45483 ----- TCS 952-6 1984-1992 Crk Frt Seal Set Use w/OP 45565-1	RS 407-5 1984-1992 Radial 40408-1	SS 403-5 1984-1992 72630 ----- SS 407-6 1984-1989 Auxiliary 72681
OP 952-5 1989-1992 30460 ----- OP 958-6 1993-1994 30665	MS 958-5 1989-1994 94328	EMS 958-5 1989-1994 95470	VS 908-6 1989-1992 w/Semi-Circular Plug & Spark Plug Seals 50041 ----- VS 958-6 1993-1994 w/Semi-Circular Plug & Spark Plug Seals 50434	TCS 952-5 1989-1994 Cam Frt Seal Set 2 Required 95483 ----- TCS 952-6 1989-1992 Crk Frt Seal Set Use w/OP 45565-1 ----- TCS 958-6 1993-1994 Crk Frt Seal Set Use w/OP 45941	RS 407-5 1989-1992 Radial 40408-1	SS 908-4 1989-1994 70359
OP 958-6 1993 30665	MS 906-5 1993 95471	EMS 958-5 1993 95470	VS 906-5 1993 w/Spark Plug Seals 50435	TCS 952-5 1993 Cam Frt Seal Set 45483 ----- TCS 958-6 1993 Crk Frt Seal Set Use w/OP 45941	RS 910-5 1993 Radial 40648	SS 910-5 1993 70660



ENGINE INFORMATION	HEAD GASKET	HEAD KIT With <u>NO</u> Valve Stem Seals	HEAD SET With Valve Stem Seals	KIT SET	SHORT BLOCK SET
--------------------	-------------	--	--------------------------------------	---------	-----------------

Chrysler, Dodge, Plymouth, & Eagle Cars: 4 Cyl

2.0L 122 1997cc DOHC Turbo L4 Mitsubishi 4G63-T Engine, 16 Vlv 1989-98 VIN F 1993-1998 VIN U 1989-1992	HG 908-5 1989-1998 9627	HK 908-5 1989-1992 9627 ----- HK 908-6 1993-1994 9627-1 ----- HK 908-8 1995-1998 9627-3	HS 908-5 1989-1992 9627 ----- HS 908-6 1993-1994 9627-1 ----- HS 908-8 1995-1998 9627-3	KS 908-5 1989-1992 9627 ----- KS 908-6 1993-1994 9627-1 ----- KS 908-8 1995-1998 9627-3	ER 908-5 1989-1992 9627 ----- ER 908-6 1993-1994 9627-1 ----- ER 908-8 1995-1998 9627-3
2.2L 132 2265cc SOHC L4 Renault J7T Engine, 8 Vlv 1988-89 VIN F 1988-1989	HG 922-5 1988-1989 9544	HK 922-5 1988-1989 9544	HS 922-5 1988-1989 9544	KS 922-5 1988-1989 9544	ER 922-5 1988-1989 9544



OIL PAN SET	INTAKE MANIFOLD SET	EXHAUST MANIFOLD SET	VALVE COVER SET	TIMING COVER SET	REAR SEAL SET	VALVE STEM SEAL SET
-------------	---------------------	----------------------	-----------------	------------------	---------------	---------------------

Chrysler, Dodge, Plymouth, & Eagle Cars: 4 Cyl

<p>OP 952-5 1989-1992 30460 ----- OP 958-6 1993-1998 30665</p>	<p>MS 952-5 1989-1994 94328 ----- MS 908-5 1995-1998 91837</p>	<p>EMS 958-5 1989-1998 95470</p>	<p>VS 908-6 1989-1992 w/Semi-Circular Plug & Spark Plug Seals 50041 ----- VS 958-6 1993-1994 w/Semi-Circular Plug & Spark Plug Seals 50434</p>	<p>TCS 952-5 1989-1998 Cam Frt Seal Set 2 Required 45483 ----- TCS 952-6 1989-1992 Crk Frt Seal Set Use w/OP 45565-1 ----- TCS 958-6 1993-1998 Crk Frt Seal Set Use w/OP 45941</p>	<p>RS 407-5 1989-1992 Radial 40408-1 ----- RS 910-5 1993-1998 Radial 40648</p>	<p>SS 908-4 1989-1998 70359</p>
<p>OP 922-5 1988-1989 30549</p>	<p>MS 922-5 1988-1989 93949</p>	<p>EMS 922-5 1988-1989 93950</p>	<p>VS 922-5 1988-1989 50318</p>	<p>TCS 922-5 1988-1989 Cam Frt Seal Set 45725</p>	<p>RS 922-5 1988-1989 Radial 40545</p>	<p>SS 081-5 1988-1989 72657</p>



ENGINE INFORMATION	HEAD GASKET	HEAD KIT With <u>NO</u> Valve Stem Seals	HEAD SET With Valve Stem Seals	KIT SET	SHORT BLOCK SET
--------------------	-------------	--	--------------------------------------	---------	-----------------

Chrysler, Dodge, Plymouth, & Eagle Cars: 4 Cyl

<p>2.2L 135 SOHC L4 Chrysler Engine, 8 Vlv 1981-94</p> <p>VIN B 1981-1982 VIN C 1983-1988 VIN D 1983-1994 VIN F 1983-1986 (H.P.) VIN 8 1983-1988 (H.O.)</p>	<p>HG 408-6 1981-1994 9296</p>	<p>HK 408-5 1981-1994 4 Pc. VC 9296-2 ----- HK 408-7 1989-1990 1 Pc. Silicone VC 8763-3 ----- HK 408-10 1994 9296-3</p>	<p>HS 408-5 1981-1994 4 Pc. VC 9296-2 ----- HS 408-7 1989-1990 1 Pc. Silicone VC 8763-3 ----- HS 408-10 1994 9296-3</p>	<p>KS 408-5 1981-1994 4 Pc. VC 9296-2 ----- KS 408-7 1989-1990 1 Pc. Silicone VC 8763-3 ----- KS 408-10 1994 9296-3</p>	<p>ER 408-5 1981-1994 4 Pc. VC 9296-2 ----- ER 408-7 1989-1990 1 Pc. Silicone VC 8763-3 ----- ER 408-10 1994 9296-3</p>
<p>Replacement of Head Bolts Required</p>	<p>Head Bolts</p> <p>HB 408-5 1981-1985 10 mm 72118 ----- HB 408-6 1985-1994 11 mm 72723</p>				



OIL PAN SET	INTAKE MANIFOLD SET	EXHAUST MANIFOLD SET	VALVE COVER SET	TIMING COVER SET	REAR SEAL SET	VALVE STEM SEAL SET
-------------	---------------------	----------------------	-----------------	------------------	---------------	---------------------

Chrysler, Dodge, Plymouth, & Eagle Cars: 4 Cyl

<p>OP 408-5 1981-1988 30422 ----- OP 408-8 1989-1994 30612</p>	<p>MS 408-5 1981-1994 90947</p>	<p>USE MS</p>	<p>VS 408-5 1981-1994 4 Pc. VC 50205 ----- VS 408-9 1989-1990 1 Pc. Silicone 50370 ----- VS 408-8 1994 50334</p>	<p>TCS 408-2 1981-1988 Cam Frt & Rear 53.59mm Rear 45691 ----- TCS 408-3 1981-1988 Cam Frt & Rear 52.45mm Rear 45690 ----- TCS 408-4 1981-1988 Cam Rear Seal 52.45mm Rear Yellow Stripe 45699 ----- TCS 408-6 1981-1988 Cam Rear Seal 53.59mm Rear White Stripe 45700 ----- TCS 408-5 1981-1988 Crk Frt Seal Set 1981-1994 Cam Frt Seal Set 45495 ----- TCS 408-7 1989-1994 Crk Frt Seal Set 45131 ----- TCS 408-8 1986-1994 Cam Rear Plug 45833 ----- TCS 408-9 1981-1994 Auxiliary Shaft Seal 45026</p>	<p>RS 408-5 1981-1994 Radial 40168-1 ----- RS 408-8 1981-1994 Radial PTFE 40627</p>	<p>SS 408-5 1981-1994 72522</p>
--	---	---------------	--	---	---	---



ENGINE INFORMATION	HEAD GASKET	HEAD KIT With <u>NO</u> Valve Stem Seals	HEAD SET With Valve Stem Seals	KIT SET	SHORT BLOCK SET
--------------------	-------------	--	--------------------------------------	---------	-----------------

Chrysler, Dodge, Plymouth, & Eagle Cars: 4 Cyl

<p>2.2L 135 SOHC Turbo L4 Chrysler Engine, 8 Vlv 1984-90</p> <p>VIN A 1987-1989 VIN C 1990 VIN E 1984-1989 VIN P 1989</p>	<p>HG 408-6 1984-1990 9296</p>	<p>HK 408-6 1984-1987 9296</p> <p>-----</p> <p>HK 408-8 1988-1990 9296-1</p>	<p>HS 408-6 1984-1987 9296</p> <p>-----</p> <p>HS 408-8 1988-1990 9296-1</p>	<p>KS 408-6 1984-1987 9296</p> <p>-----</p> <p>KS 408-8 1988-1990 9296-1</p>	<p>ER 408-6 1984-1987 9296</p> <p>-----</p> <p>ER 408-8 1988-1990 9296-1</p>
<p>Replacement of Head Bolts Required</p>	<p>Head Bolts HB 408-5 1984-1985 10 mm 72118</p> <p>-----</p> <p>HB 408-6 1985-1990 11 mm 72723</p>				



OIL PAN SET	INTAKE MANIFOLD SET	EXHAUST MANIFOLD SET	VALVE COVER SET	TIMING COVER SET	REAR SEAL SET	VALVE STEM SEAL SET
-------------	---------------------	----------------------	-----------------	------------------	---------------	---------------------

Chrysler, Dodge, Plymouth, & Eagle Cars: 4 Cyl

OP 408-5 1984-1988 30422 ----- OP 408-8 1989-1990 30612	MS 408-5 1984-1990 90947	USE MS	VS 408-6 1984-1987 50257 ----- VS 408-8 1988-1990 1 Pc. Silicone 50334	TCS 408-2 1984-1988 Cam Frt & Rear 53.59mm Rear 45691 ----- TCS 408-3 1984-1988 Cam Frt & Rear 52.45mm Rear 45690 ----- TCS 408-4 1984-1988 Cam Rear Seal 52.45mm Rear Yellow Stripe 45699 ----- TCS 408-6 1984-1988 Cam Rear Seal 53.59mm Rear White Stripe 45700 ----- TCS 408-5 1984-1988 Crk Frt Seal Set 1984-1990 Cam Frt Seal Set 45495 ----- TCS 408-7 1989-1990 Crk Frt Seal Set 45131 ----- TCS 408-8 1986-1990 Cam Rear Plug 45833 ----- TCS 408-9 1984-1990 Auxiliary Shaft Seal 45026	RS 408-5 1984-1990 Radial 40168-1 ----- RS 408-8 1984-1990 Radial PTFE 40627	SS408-5 1984-1990 72522
---	--------------------------------	--------	---	--	--	-------------------------------



ENGINE INFORMATION	HEAD GASKET	HEAD KIT With <u>NO</u> Valve Stem Seals	HEAD SET With Valve Stem Seals	KIT SET	SHORT BLOCK SET
--------------------	-------------	--	--------------------------------------	---------	-----------------

Chrysler, Dodge, Plymouth, & Eagle Cars: 4 Cyl

2.4L 143.4 2351cc SOHC L4 Mitsubishi 4G64 Engine, 8 Valve 1992 VIN W 1992	HG 952-8 1992 9388	HK 952-8 1992 9388-2	HS 952-8 1992 9388-2	KS 952-8 1992 9388-2	ER 952-8 1992 9388-2
2.4L 143.4 2351cc SOHC L4 Mitsubishi 4G64 Engine, 16 Valve 1993-2005 VIN G 1993-1996 VIN G 2001-2005	HG 906-6 1993-1996 9932 ----- HG 958-10 2001-2005 26172	HK 906-6 1993-1996 9932 ----- HK 958-10 2001-2005 26172	HS 906-6 1993-1996 9932 ----- HS 958-10 2001-2005 26172	KS 906-6 1993-1996 9932 ----- KS 958-10 2001-2005 26172	ER 906-6 1993-1996 9932 ----- ER 958-10 2001-2005 26172
2.4L 148 DOHC L4 Chrysler Engine, 16 Valve 1995-2006 VIN J 2004-2006 VIN X 1995-2006	HG 428-4 1995-2001 9924 ----- HG 428-5 1995-2001 .010 Thicker 26502 ----- HG 428-6 2002-2004 26206 ----- HG 428-8 2005-2006 26202 ----- Head Bolts HB 428-5 1995-2007 71028	HK 428-4 1995-2001 9924 ----- HK 428-6 2002-2004 26206 ----- HK 428-8 2005-2006 26202	HS 428-4 1995-2001 9924 ----- HS 428-6 2002-2004 26206 ----- HS 428-8 2005-2006 26202	KS 428-4 1995-2001 9924 ----- KS 428-6 2002-2004 26206 ----- KS 428-8 2005-2006 26202	ER 428-4 1995-2001 9924 ----- ER 428-6 2002-2004 26206 ----- ER 428-8 2005-2006 26202



OIL PAN SET	INTAKE MANIFOLD SET	EXHAUST MANIFOLD SET	VALVE COVER SET	TIMING COVER SET	REAR SEAL SET	VALVE STEM SEAL SET
-------------	---------------------	----------------------	-----------------	------------------	---------------	---------------------

Chrysler, Dodge, Plymouth, & Eagle Cars: 4 Cyl

<p>OP 952-5 1992 30460</p>	<p>MS 952-6 1992 Upper & Lower 92964-4 ----- MS 952-8 1992 Upper 94323</p>	<p>EMS 952-5 1992 92029</p>	<p>VS 908-5 1992 w/Grommets & Semi-Circular Plug 50132</p>	<p>TCS 952-5 1992 Cam Frt Seal Set 45483 ----- TCS 952-7 1992 Crk Frt Seal Set Use w/OP 45665-3</p>	<p>RS 407-5 1992 Radial 40408-1</p>	<p>SS 403-5 1992 72630 ----- SS 407-6 1992 Auxiliary 72681</p>
<p>OP 958-6 1993-1996 30665 ----- OP 952-9 2001-2005 30715</p>	<p>MS 958-6 1993-1996 95471 ----- MS 952-8 2001-2005 96075</p>	<p>EMS958-5 1993-1996 2001-2005 95470</p>	<p>VS 906-5 1993-1996 w/Spark Plug Seals 50435 ----- VS 952-8 2001-2005 50562</p>	<p>TCS 952-5 1993-1996 2001-2005 Cam Frt Seal Set 45483 ----- TCS 958-6 1993-1996 Crk Frt Seal Set Use w/OP 45941 ----- TCS 958-7 2001-2005 Crk Frt Seal Set Use w/OP 46024</p>	<p>RS 910-5 1993-1996 2001-2005 Radial 40648</p>	<p>SS 910-5 1993-1996 2001-2005 70660</p>
<p>OP 428-5 1995-2006 30676</p>	<p>MS 428-5 1995-2000 95660 ----- MS 428-6 2001-2006 Exc. PT Cruiser 92888 ----- MS 428.8 2001-2006 PT Cruiser 93219</p>	<p>EMS 428-2 1995-2006 95692 ----- EMS 428-4 2001-2006 92846</p>	<p>VS 428-4 1995-2004 w/Spark Plug Seal 50459 ----- VS 428-5 2005-2006 w/Spark Plug Seal 50518</p>	<p>TCS 411-4 1995-2006 Cam Frt Seal Set 2 Required 45961 ----- TCS 411-5 Crk Frt Seal Set 45962</p>	<p>RS 411-5 1995-2006 Radial 40182 ----- RS 408-8 1985-2006 Radial PTFE 40627</p>	<p>SS 414-5 1995-2006 72871</p>



ENGINE INFORMATION	HEAD GASKET	HEAD KIT With <u>NO</u> Valve Stem Seals	HEAD SET With Valve Stem Seals	KIT SET	SHORT BLOCK SET
--------------------	-------------	--	--------------------------------------	---------	-----------------

Chrysler, Dodge, Plymouth, & Eagle Cars: 4 Cyl

2.4L 148 DOHC Turbo L4 Chrysler Engine, 16 Valve 2003-06 VIN G 2003 VIN S 2004-2006	HG 428-8 2003-2006 26202	HK 428-8 2003-2006 26202	HS 428-8 2003-2006 26202	KS 428-8 2003-2006 26202	ER 428-8 2003-2006 26202
2.5L 150 OHV L4 AMC Engine, 8 Valve 1988-89 VIN H 1989 VIN Z 1988	HG 083-0 1988-1989 9196	HK 083-0 1988-1989 9196-1	HS 083-0 1988-1989 9196-1	KS 083-0 1988-1989 9196-1	ER 083-0 1988-1989 9196-1



OIL PAN SET	INTAKE MANIFOLD SET	EXHAUST MANIFOLD SET	VALVE COVER SET	TIMING COVER SET	REAR SEAL SET	VALVE STEM SEAL SET
-------------	---------------------	----------------------	-----------------	------------------	---------------	---------------------

Chrysler, Dodge, Plymouth, & Eagle Cars: 4 Cyl

OP 428-8 2003-2006 30728	MS 428-7 2003-2006 Exc PT Cruiser 92532 ----- MS 428.8 2001-2006 PT Cruiser 93219	EMS 428-4 2003-2006 92846	VS 428-4 2003-2006 50459	TCS 411-4 1995-2006 Cam Frt Seal Set 2 Required 45961 ----- TCS 411-5 1995-2006 Crk Frt Seal Set 45962	RS 411-5 1995-2006 Radial 40182 ----- RS 408-8 1995-2006 Radial PTFE 40627	SS 414-5 1995-2006 72871
OP 083-0 1988-1989 30476	MS 083-0 1988-1989 92100	USE MS	VS 083-0 1988-1989 50245	TCS 082-5 1988-1989 45117	RS 312-5 1988-1989 40578	SS 083-5 1988-1989 70816



ENGINE INFORMATION	HEAD GASKET	HEAD KIT With <u>NO</u> Valve Stem Seals	HEAD SET With Valve Stem Seals	KIT SET	SHORT BLOCK SET
--------------------	-------------	--	--------------------------------------	---------	-----------------

Chrysler, Dodge, Plymouth, & Eagle Cars: 4 Cyl

2.5L 153 SOHC L4 Chrysler Engine, 8 Valve 1986-95 VIN K 1986-1995 VIN V 1993-1994 (FLEX FUEL)	HG 408-6 1986-1995 9296 ----- Head Bolts w/Washers HB 408-7 1986-1995 72723 72176	HK 408-5 1986-1995 4 Pc. VC Rear Cam Plug 52.45mm Seal N/I 9296-2 ----- HK 408-6 1989-1995 1 Pc. VC Rear Cam Plug N/I 9296-3	HS 408-5 1989-1992 9296-1	KS 408-5 1989-1992 9296-1	ER 408-5 1989-1992 9296-1
---	--	---	---------------------------------	---------------------------------	---------------------------------



OIL PAN SET	INTAKE MANIFOLD SET	EXHAUST MANIFOLD SET	VALVE COVER SET	TIMING COVER SET	REAR SEAL SET	VALVE STEM SEAL SET
-------------	---------------------	----------------------	-----------------	------------------	---------------	---------------------

Chrysler, Dodge, Plymouth, & Eagle Cars: 4 Cyl

<p>OP 408-5 1986-1987 Cork 30422 -----</p> <p>OP 408-8 1988-1995 Silicone 30612</p>	<p>MS 408-5 1986-1995 90947</p>	<p>USE MS</p>	<p>VS 408-5 1986-1995 Steel VC Cork 50205 -----</p> <p>VS 408-8 1991-1995 Aluminum VC Silicone 50334</p>	<p>TCS 408-2 1986-1988 Cam Frt & Rear 53.59mm Rear 45691 -----</p> <p>TCS 408-3 1986-1988 Cam Frt & Rear 52.45mm Rear 45690 -----</p> <p>TCS 408-4 1986-1988 Cam Rear Seal 52.45mm Rear Yellow Stripe 45699 -----</p> <p>TCS 408-5 1986-1995 Timing Cover Set 45495 -----</p> <p>TCS 408-6 1986-1988 Cam Rear Seal 53.59mm Rear White Stripe 45700 -----</p> <p>TCS 408-7 1986-1995 Crk Frt Seal Set 45131 -----</p> <p>TCS 408-8 1986-1995 Cam Rear Plug 45833 -----</p> <p>TCS 408-9 1986-1995 Auxiliary Shaft Seal 45026</p>	<p>RS 408-5 1986-1995 Radial 40168-1 -----</p> <p>RS 408-8 1986-1995 Radial PTFE 40627</p>	<p>SS 408-5 1986-1995 72522</p>
---	---	---------------	--	---	--	---



ENGINE INFORMATION	HEAD GASKET	HEAD KIT With <u>NO</u> Valve Stem Seals	HEAD SET With Valve Stem Seals	KIT SET	SHORT BLOCK SET
--------------------	-------------	--	--------------------------------------	---------	-----------------

Chrysler, Dodge, Plymouth, & Eagle Cars: 4 Cyl

2.5L 153 SOHC Turbo L4 Chrysler Engine, 8 Valve 1989-92 VIN J 1989-1992	HG 408-6 1989-1992 9296 ----- Head Bolts w/Washers HB 408-7 1989-1992 72723 72176	HK 408-8 1989-1992 9296-1	HS 408-8 1989-1992 9296-1	KS 408-8 1989-1992 9296-1	ER 408-8 1989-1992 9296-1
2.6L 156 2555cc SOHC L4 Mitsubishi G54B Engine, 8 Valve F 1978-85 VIN D 1981-1982 VIN F 1978-1980 VIN G 1983-1985 VIN 7 1981-1983	HG 407-2 1978-1980 8768 ----- HG 407-5 1981-1985 8770	HK 407-2 1978-1980 8768 ----- HK 407-5 1981-1985 RWD 8770-1 ----- HK 407-8 1981-1985 FWD 8770	HS 407-2 1978-1980 8768 ----- HS 407-5 1981-1985 RWD 8770-1 ----- HS 407-8 1981-1985 FWD 8770	KS 407-2 1978-1980 8768 ----- KS 407-5 1981-1985 RWD 8770-1 ----- KS 407-8 1981-1985 FWD 8770	ER 407-2 1978-1980 8768 ----- ER 407-5 1981-1985 RWD 8770-1 ----- ER 407-8 1981-1985 FWD 8770
2.6L 156 2555cc SOHC Turbo L4 Mitsubishi G54B-T Engine, 8 Valve 1984-89 VIN H 1984-1987 VIN N 1985-1989	HG 407-5 1984-1989 To 2-28-87 8770 ----- HG 407-7 1987-1989 From 3-1-87 9116	HK 407-6 1984-1989 To 2-28-87 8770-3 ----- HK 407-7 1987-1989 From 3-1-87 9116	HS 407-6 1984-1989 To 2-28-87 8770-3 ----- HS 407-7 1987-1989 From 3-1-87 9116	KS 407-6 1984-1989 To 2-28-87 8770-3 ----- KS407-7 1987-1989 From 3-1-87 9116	ER 407-6 1984-1989 To 2-28-87 8770-3 ----- ER 407-7 1987-1989 From 3-1-87 9116



OIL PAN SET	INTAKE MANIFOLD SET	EXHAUST MANIFOLD SET	VALVE COVER SET	TIMING COVER SET	REAR SEAL SET	VALVE STEM SEAL SET
-------------	---------------------	----------------------	-----------------	------------------	---------------	---------------------

Chrysler, Dodge, Plymouth, & Eagle Cars: 4 Cyl

<p>OP 408-8 1989-1992 30612</p>	<p>MS 408-5 1989-1992 90947</p>	<p>USE MS</p>	<p>VS 408-8 1989-1992 50334</p>	<p>TCS 408-5 1984-1988 Crk Frt Seal Set 1984-1990 Cam Frt Seal Set 45495 ----- TCS 408-7 1989-1990 Crk Frt Seal Set 45131 ----- TCS 408-8 1986-1990 Cam Rear Plug 45833 ----- TCS 408-9 1984-1990 Auxiliary Shaft Seal 45026</p>	<p>RS 408-5 1989-1992 Radial 40168-1 ----- RS 408-8 1989-1992 Radial PTFE 40627</p>	<p>SS 408-5 1989-1992 72522</p>
<p>OP 407-5 1978-1985 30400</p>	<p>MS 407-2 1978-1980 22811 ----- MS 407-6 1981-1985 90981</p>	<p>EMS 409-4 1978-1980 22812 ----- EMS 407-5 1981-1985 90995</p>	<p>VS 407-5 1978-1980 w/Grommets & Semi-Circular Plug 50139 ----- VS 407-6 1981-1985 w/Grommets & Semi-Circular Plug 50146</p>	<p>TCS 407-5 1978-1985 Crk Frt Seal Set 45170 ----- TCS 407-6 1981-1985 Cam Rear Seal FWD 45847 ----- TCS 407-7 1981-1983 Cam Rear Plug RWD 45849</p>	<p>RS 407-5 1978-1985 40408-1</p>	<p>SS 407-5 1978-1985 70598 ----- SS 407-6 1978-1985 Auxiliary 72681</p>
<p>OP 407-5 1984-1989 30400</p>	<p>MS 407-5 1984-1989 90981</p>	<p>EMS 407-5 1984-1989 90995</p>	<p>VS 407-6 1984-1989 w/Grommets & Semi-Circular Plug 50146</p>	<p>TCS 407-5 1984-1989 Crk Frt Seal Set 45170 ----- TCS 407-8 1984-1989 Cam Rear Plug 45848</p>	<p>RS 407-5 1984-1989 40408-1</p>	<p>SS 407-5 1984-1989 70598 ----- SS 407-6 1984-1989 Auxiliary 72681</p>



ENGINE INFORMATION	HEAD GASKET	HEAD KIT With <u>NO</u> Valve Stem Seals	HEAD SET With Valve Stem Seals	KIT SET	SHORT BLOCK SET
--------------------	-------------	--	--------------------------------------	---------	-----------------

Chrysler, Dodge, Plymouth, & Eagle Cars: 6 Cyl

2.5L 152.2 2497cc SOHC V6 Mitsubishi 6G73 Engine, 24 Valve EEB 1995-2000 VIN H 1995-2000 VIN N 1995-2000	HG 962-5 1995-1997 9037 ----- HG 962-8 1998-2000 9158 Head Bolts HB-426-5 1998-2000 72859	HK 962-5 1995-1997 9037 ----- HK 962-8 1998-2000 9158	HS 962-5 1995-1997 9037 ----- HS 962-8 1998-2000 9158	KS 962-5 1995-1997 9037 ----- KS 962-8 1998-2000 9158	ER 962-5 1995-1997 9037 ----- ER 962-8 1998-2000 9158
2.7L 167 DOHC V6 Chrysler Engine, 24 Valve 1998-06 VIN R 1998-2006 VIN T 2003-2006 (FLEX FUEL) VIN U 2000-2006	HG 423-4R 1998-2006 Right Hand 9517 ----- HG 423-5L 1998-2006 Left Hand 9514	HK 423-5 1998-2000 9514 ----- HK 423-6 2001-2006 9514-1	HS 423-5 1998-2000 9514 ----- HS 423-6 2001-2006 9514-1	KS 423-5 1998-2000 9514 ----- KS 423-6 2001-2006 9514-1	ER 423-5 1998-2000 9514 ----- ER 423-6 2001-2006 9514-1
2.8L 170 OHV L6 Chrysler Engine, 12 Valve 1960-71	HG 404-5 1960-1971 7918-1	HK 404-5 1960-1971 7918-4	HS 404-5 1960-1971 7918-4	KS 404-5 1960-1971 7918-4	ER 404-5 1960-1971 7918-4
3.0L 181 2970cc SOHC V6 Volvo PRV Engine 1988-92 VIN J 1988 VIN U 1989-1992	HG 932-2R 1988-1992 Right Hand To Eng 89615 9389-1 ----- HG 932-3L 1988-1992 Left Hand To Eng 89615 9387-1 ----- HG 932-4R 1988-1992 Right Hand From Eng 89616 9837 ----- HG 932-5L 1988-1992 Left Hand From Eng 89616 9836	HK 932-2 1988-1992 To Eng 89615 9387-1 ----- HK 932-4 1988-1992 From Eng 89616 9836	HS 932-2 1988-1992 To Eng 89615 9387-1 ----- HS 932-4 1988-1992 From Eng 89616 9836	KS 932-2 1988-1992 To Eng 89615 9387-1 ----- KS 932-4 1988-1992 From Eng 89616 9836	ER 932-2 1988-1992 To Eng 89615 9387-1 ----- ER 932-4 1988-1992 From Eng 89616 9836



OIL PAN SET	INTAKE MANIFOLD SET	EXHAUST MANIFOLD SET	VALVE COVER SET	TIMING COVER SET	REAR SEAL SET	VALVE STEM SEAL SET
-------------	---------------------	----------------------	-----------------	------------------	---------------	---------------------

Chrysler, Dodge, Plymouth, & Eagle Cars: 6 Cyl

<p>OP 962-5 1995-2000 30672</p>	<p>MS 426-5 1995-2000 Upper & Lower Set 95709 ----- MS 426-6 1995-2000 Upper Set 95708</p>	<p>EMS 426-5 1995-2000 95711</p>	<p>VS 426-5 1995-2000 w/Spark Plug Seals 50461 ----- Spark Plug Seals SPS-426-5 1995-2000 6 Per Pkg.</p>	<p>TCS 426-5 1995-2000 Cam Frt Seal 2 Required 45483 ----- TCS 962-6 1995-2000 Crk Frt Seal 45965</p>	<p>RS 410-5 1995-2000 Radial 40562 ----- RS 408-8 1995-2000 Radial PTFE 40627</p>	<p>SS 426-5 1995-2000 70795</p>
<p>OP 423-5 1998-2006 30689</p>	<p>MS 423-5 1998-2006 Upper & Lower 91473 ----- THROTTLE BODY TB 423-5 1998-2004 61107</p>	<p>EMS 423-5 1998-2006 91483</p>	<p>VS 423-5 1998-2000 50496 ----- VS 423-6 2001-2006 50520</p>	<p>TCS 423-5 1998-2006 45035</p>	<p>RS 423-5 1998-2006 Radial 40657</p>	<p>SS 423-5 1998-2006 72871-1X2</p>
<p>OP 404-5 1960-1971 12705-1</p>	<p>MS 404-5 1960-1971 9610-1</p>	<p>USE MS</p>	<p>VS 404-5 1960-1971 12680</p>	<p>TCS 404-5 1960-1971 12769-1</p>	<p>RS 404-5 1960-1971 2 Pc. Rubber 40240</p>	<p>SS 404-5 1960-1971 13955/12764</p>
<p>OP 932-5 1988-1992 30596</p>	<p>MS 932-5 1988-1992 22778</p>	<p>EMS 932-5 1988-1992 94124</p>	<p>VS 932-5 1988-1992 26090</p>	<p>TCS 932-5 1988-1992 45841-1</p>	<p>RS 932-5 1988-1992 Radial 40493-1</p>	<p>SS 932-5 1988-1992 72567-1</p>



ENGINE INFORMATION	HEAD GASKET	HEAD KIT With <u>NO</u> Valve Stem Seals	HEAD SET With Valve Stem Seals	KIT SET	SHORT BLOCK SET
--------------------	-------------	--	--------------------------------------	---------	-----------------

Chrysler, Dodge, Plymouth, & Eagle Cars: 6 Cyl

<p>3.0L 181.1 2972cc SOHC V6 Mitsubishi 6G72 Engine, 12 Valve 1988-96</p> <p>VIN H 1993-1996 VIN S 1990-1992 VIN 3 1988-1995</p>	<p>HG 410-2 1988-1996 9112</p> <p>Head Bolts HB-426-5 1988-1996 72859</p>	<p>HK 410-2 1988-1995 Exc. 1991-1996 Stealth 9112 ----- HK 410-4 1991-1996 Stealth 9112-2</p>	<p>HS 410-2 1988-1995 Exc. 1991-1996 Stealth 9112 ----- HS 410-4 1991-1996 Stealth 9112-2</p>	<p>KS410-2 1988-1995 Exc. 1991-1996 Stealth 9112 ----- KS 410-4 1991-1996 Stealth 9112-2</p>	<p>ER410-2 1988-1995 Exc. 1991-1996 Stealth 9112 ----- ER 410-4 1991-1996 Stealth 9112-2</p>
<p>3.0L 181.1 2972cc DOHC V6 Mitsubishi 6G72 Engine, 24 Valve 1991-96</p> <p>VIN B 1991-1992 VIN J 1993-1996</p>	<p>HG 424-5 1991-1993 9842 ----- HG 424-6 1994-1996 26186</p>	<p>HK 424-5 1991-1993 9842 ----- HK 424-6 1994-1995 To 10-3-94 26186 ----- HK 424-7 1995-1996 From 10-4-94 26186-1</p>	<p>HS 424-5 1991-1993 9842 ----- HS 424-6 1994-1995 To 10-3-94 26186 ----- HS 424-7 1995-1996 From 10-4-94 26186-1</p>	<p>KS 424-5 1991-1993 9842 ----- KS 424-6 1994-1995 To 10-3-94 26186 ----- KS 424-7 1995-1996 From 10-4-94 26186-1</p>	<p>ER 424-5 1991-1993 9842 ----- ER 424-6 1994-1995 To 10-3-94 26186 ----- ER 424-7 1995-1996 From 10-4-94 26186-1</p>
<p>3.0L 181.1 2972cc SOHC V6 Mitsubishi 6G72 Engine, 24 Vlv EF7 2001-05</p> <p>VIN H 2001-2005</p>	<p>HG 426-5 2001-2005 9537</p> <p>Head Bolts HB-426-5 2001-2005 72859</p>	<p>HK 426-5 2001-2005 9537</p>	<p>HS 426-5 2001-2005 9537</p>	<p>KS 426-5 2001-2005 9537</p>	<p>ER 426-5 2001-2005 9537</p>
<p>3.0L 181.1 2972cc DOHC Turbo V6 Mitsubishi 6G72-T Engine, 24 Vlv 1991-96</p> <p>VIN C 1991-1992 VIN K 1993-1996</p>	<p>HG 424-6 1991-1996 26186</p>	<p>HK 424-6 1991-1995 To 10-3-94 26186 ----- HK 424-7 1995-1996 From 10-4-94 26186-1</p>	<p>HS 424-6 1991-1995 To 10-3-94 26186 ----- HS 424-7 1995-1996 From 10-4-94 26186-1</p>	<p>KS 424-6 1991-1995 To 10-3-94 26186 ----- KS 424-7 1995-1996 From 10-4-94 26186-1</p>	<p>ER 424-6 1991-1995 To 10-3-94 26186 ----- ER 424-7 1995-1996 From 10-4-94 26186-1</p>

OIL PAN SET	INTAKE MANIFOLD SET	EXHAUST MANIFOLD SET	VALVE COVER SET	TIMING COVER SET	REAR SEAL SET	VALVE STEM SEAL SET
-------------	---------------------	----------------------	-----------------	------------------	---------------	---------------------

Chrysler, Dodge, Plymouth, & Eagle Cars: 6 Cyl

<p>OP 410-5 1988-1996 30570</p>	<p>MS 410-5 1988-1995 Upper & Lower Exc Stealth 93795 ----- MS 410-6 1991-1996 Upper & Lower Stealth 93795-3 ----- MS 410-8 1988-1995 Upper Set Exc. Stealth 93796</p>	<p>EMS 410-5 1988-1996 93797</p>	<p>VS 410-5 1988-1996 w/Grommets & Circular Plugs 50173</p>	<p>TCS 410-2 1988-1996 Cam Frt Seal Set 2 Required Use w/ VS 45483 ----- TCS 410-5 1988-1996 Crk Frt Seal Set 45750</p>	<p>RS 410-5 1988-1996 Radial 40562 ----- RS 408-8 1988-1996 Radial PTFE 40627</p>	<p>SS 410-5 1988-1996 70710</p>
<p>OP 410-5 1991-1992 30570</p>	<p>MS 424-5 1991-1996 Upper & Lower 94946 ----- MS 424-6 1991-1996 Upper Set 95008</p>	<p>EMS 424-5 1991-1996 95082</p>	<p>VS 424-5 1991-1996 w/ Spark Plug Seals 50390</p>	<p>TCS 424-5 1991-1996 Cam Frt Seal 4 Required Use w/VS 45901 ----- TCS 424-6 1991-1996 Crk Frt Seal Set 45911</p>	<p>RS 410-5 1991-1992 Radial 40562 ----- RS 408-8 1981-1992 Radial PTFE 40627 ----- RS 424-5 1993-1996 Radial 40660</p>	<p>SS 424-5 1991-1995 To 10-3-94 72805X2 ----- SS 424-6 1995-1996 From 10-4-94 71789</p>
<p>OP 426-5 2001-2005 30707 LOWER</p>	<p>MS 426-5 2001-2005 Upper & Lower Set 95709 ----- MS 426-6 2001-2005 Upper Set 95708</p>	<p>EMS 426-5 2001-2005 95711</p>	<p>VS 426-5 2001-2005 w/ Spark Plug Seals 50461 ----- Spark Plug Seals SPS-426-5 2001-2005 6 Per Pkg.</p>	<p>TCS 426-5 2001-2005 Cam Frt Seal 2 Required 45483 ----- TCS 426-6 2001-2005 Crk Frt Seal Set 45985</p>	<p>RS 424-5 2001-2005 Radial 40660</p>	<p>SS 426-5 2001-2005 70795</p>
<p>OP 410-5 1991-1992 30570</p>	<p>MS 424-5 1991-1996 Upper & Lower 94946 ----- MS 424-6 1991-1996 Upper Set 95008</p>	<p>EMS 424-5 1991-1996 95082</p>	<p>VS 424-5 1991-1996 w/ Spark Plug Seals 50390</p>	<p>TCS 424-5 1991-1996 Cam Frt Seal 4 Required Use w/VS 45901 ----- TCS 424-6 1991-1996 Crk Frt Seal Set 45911</p>	<p>RS 424-5 1991-1996 Radial 40660</p>	<p>SS 424-5 1991-1995 To 10-3-94 72805X2 ----- SS 424-6 1995-1996 From 10-4-94 71789</p>



ENGINE INFORMATION	HEAD GASKET	HEAD KIT With <u>NO</u> Valve Stem Seals	HEAD SET With Valve Stem Seals	KIT SET	SHORT BLOCK SET
--------------------	-------------	--	--------------------------------------	---------	-----------------

Chrysler, Dodge, Plymouth, & Eagle Cars: 6 Cyl

3.2L 197 SOHC V6 Chrysler Engine, 24 Vlv EGW 1998-01 VIN J 1998-2001	HG 422-2R 1998-2001 Right Hand 9455 ----- HG 422-4L 1998-2001 Left Hand 9425	HK 422-4 1998-2001 9425	HS 422-4 1998-2001 9425	KS 422-4 1998-2001 9425	ER 422-4 1998-2001 9425
3.2L 198 OHV L6 Chrysler Engine, 12 Vlv 1970-74 VIN B 1970-1974	HG 404-5 1970-1974 7918-1	HK 404-5 1970-1974 7918-4	HS 404-5 1970-1974 7918-4	KS 404-5 1970-1974 7918-4	ER 404-5 1970-1974 7918-4
3.3L 201 OHV V6 Chrysler Engine, 12 Vlv 1990-97 VIN R 1990-1993 VIN T 1993-1997 VIN U 1994-1996 (FLEX FUEL)	HG 420-2R 1990-1997 Right Side 9673-1 ----- HG 420-4L 1990-1997 Left Side 9676-1	HK 420-2 1990-1997 Int. Man. N/I 9676	HS 420-2 1990-1997 Int. Man. N/I 9676	KS 420-2 1990-1997 Int. Man. N/I 9676	ER 420-2 1990-1997 Int. Man. N/I 9676



OIL PAN SET	INTAKE MANIFOLD SET	EXHAUST MANIFOLD SET	VALVE COVER SET	TIMING COVER SET	REAR SEAL SET	VALVE STEM SEAL SET
-------------	---------------------	----------------------	-----------------	------------------	---------------	---------------------

Chrysler, Dodge, Plymouth, & Eagle Cars: 6 Cyl

<p>OP 422-4 1998-2001 30692</p>	<p>MS 422-4 1998-2001 Upper & Lower 92165 ----- MS 422-6 1991-1996 Upper Set 91990 ----- THROTTLE BODY TB 422-4 1998-2001 61068</p>	<p>EMS 422-4 1998-2001 95446</p>	<p>VS 422-4 1998-2001 50501</p>	<p>TCS 422-4 1998-2001 Cam Frt Seal 2 Required 45939 ----- TCS 422-6 1998-2001 Crk Frt Seal Set 45992</p>	<p>RS 423-5 1998-2001 Radial 40657</p>	<p>SS 418-5 1998-2001 72842X2</p>
<p>OP 404-5 1970-1974 12705-1</p>	<p>MS 404-5 1970-1974 9610-1</p>	<p>EMS USE MS</p>	<p>VS 404-5 1970-1974 12680</p>	<p>TCS 404-5 1970-1974 12769-1</p>	<p>RS 404-5 1970-1974 40240</p>	<p>SS 404-5 1970-1974 13955/12764</p>
<p>OP 420-5 1990-1997 30622</p>	<p>VP 420-5 1990-1997 Upper & Lower 96042 ----- MS 420-4 1990-1997 Upper Set 94566</p>	<p>EMS 420-2 1990-1997 94666</p>	<p>VS 420-2 1990-1997 50339</p>	<p>TCS 420-2 1990-1997 Use w/OP 45893-1</p>	<p>RS 408-5 1990-1997 Radial 40168-1 ----- RS408-8 1990-1997 Radial 40627</p>	<p>SS 420-5 1990-1997 72783</p>



ENGINE INFORMATION	HEAD GASKET	HEAD KIT With <u>NO</u> Valve Stem Seals	HEAD SET With Valve Stem Seals	KIT SET	SHORT BLOCK SET
--------------------	-------------	--	--------------------------------------	---------	-----------------

Chrysler, Dodge, Plymouth, & Eagle Cars: 6 Cyl

<p>3.5L 215 SOHC V6 Chrysler Engine, 24 Vlv 1993-06</p> <p>VIN F 1993-1997 VIN G 1998-2006 VIN K 2002-2004 VIN M 2002-2004 VIN V 2000-2004</p>	<p>HG 425-2R 1993-1997 Right Hand 9927 -----</p> <p>HG 425-4L 1993-1997 Left Hand 9926 -----</p> <p>HG 425-5R 1998-2002 Right Hand 9505 -----</p> <p>HG 425-6L 1998-2002 Left Hand 9507 -----</p> <p>HG 425-8R 2003-2006 Right Hand 26208 -----</p> <p>HG 425-9L 2003-2006 Left Hand 26209</p> <p>Head Bolts HB 425-4 1993-1997 72138 -----</p> <p>HB 425-5 1998-2006 72895</p>	<p>HK 425-2 1993-1997 9926 -----</p> <p>HK 425-4 1998-2002 9505 -----</p> <p>HK 425-5 2003-2006 26208</p>	<p>HS 425-2 1993-1997 9926 -----</p> <p>HS 425-4 1998-2002 9505 -----</p> <p>HS 425-5 2003-2006 26208</p>	<p>KS 425-2 1993-1997 9926 -----</p> <p>KS 425-4 1998-2002 9505 -----</p> <p>KS 425-5 2003-2006 26208</p>	<p>ER 425-2 1993-1997 9926 -----</p> <p>ER 425-4 1998-2002 9505 -----</p> <p>ER 425-5 2003-2006 26208</p>
<p>3.7L 225 OHV L6 Chrysler Engine, 12 Vlv 1960-83</p> <p>VIN B 1966-1969 VIN C 1966-1980 VIN D 1977-1980 VIN E 1972 & 1981-1982 VIN F, G 1981-1982 VIN H 1981-1983 VIN J, K, L 1983</p>	<p>HG 404-5 1960-1983 7918-1</p>	<p>HK 404-5 1960-1980 Exc. Aluminum Engine 7918-4 -----</p> <p>HK 404-6 1981-1983 7918-3</p>	<p>HS404-5 1960-1980 Exc. Aluminum Engine 7918-4 -----</p> <p>HS 404-6 1981-1983 7918-3</p>	<p>KS404-5 1960-1980 Exc. Aluminum Engine 7918-4 -----</p> <p>KS 404-6 1981-1983 7918-3</p>	<p>ER404-5 1960-1980 Exc. Aluminum Engine 7918-4 -----</p> <p>ER 404-6 1981-1983 7918-3</p>



OIL PAN SET	INTAKE MANIFOLD SET	EXHAUST MANIFOLD SET	VALVE COVER SET	TIMING COVER SET	REAR SEAL SET	VALVE STEM SEAL SET
-------------	---------------------	----------------------	-----------------	------------------	---------------	---------------------

Chrysler, Dodge, Plymouth, & Eagle Cars: 6 Cyl

<p>OP 425-2 1993-1997 w/Windage Tray 34212 -----</p> <p>OP 422-4 1998-2004 30692 -----</p> <p>OP 425-5 2005-2006 30754</p>	<p>MS 425-2 1993-1997 Upper & Lower Set 95444 -----</p> <p>MS 422-4 1998-2006 Upper & Lower Set 92165 -----</p> <p>MS 425-6 1993-1997 Upper Set 95445 -----</p> <p>MS 422-6 1998-2006 Upper Set 91990 -----</p> <p>THROTTLE BODY TB 422-4 1999-2004 61068</p>	<p>EMS 422-4 1993-2006 95446</p>	<p>VS 425-2 1993-1997 50429 -----</p> <p>VS 422-4 1998-2006 50501 -----</p> <p>Spark Plug Seals</p> <p>SPS-411-4 1998-2006 6 Per Pkg. 71071/71105-1</p>	<p>TCS 422-4 1993-2006 Cam Frt Seal 2 Required 45939 -----</p> <p>TCS 425-4 1993-1997 Crk Frt Seal Use w/OP 45950 -----</p> <p>TCS 422-6 1998-2006 Crk Frt Seal Use w/OP 45992</p>	<p>RS 408-5 1993-2006 Radial 40168-1 -----</p> <p>RS 408-8 1993-2006 Radial PTFE 40627</p>	<p>SS 418-5 1993-2006 72842</p>
<p>OP 404-5 1960-1983 12705-1</p>	<p>MS 404-5 1960-1983 9610-1</p>	<p>EMS USE MS</p>	<p>VS 404-5 1960-1980 12680 -----</p> <p>VS 404-6 1981-1983 50185</p>	<p>TCS 404-5 1960-1983 12769-1</p>	<p>RS 404-5 1960-1980 40240 -----</p> <p>RS 404-6 1981-1983 40489</p>	<p>SS 404-5 1960-1980 Int & Exh 12764/13955 -----</p> <p>SS 404-6 1981-1983 Int & Exh 12764/70537</p>



ENGINE INFORMATION	HEAD GASKET	HEAD KIT With <u>NO</u> Valve Stem Seals	HEAD SET With Valve Stem Seals	KIT SET	SHORT BLOCK SET
--------------------	-------------	--	--------------------------------------	---------	-----------------

Chrysler, Dodge, Plymouth, & Eagle Cars: 6 Cyl

3.8L 231 OHV V6 Chrysler Engine, 12 Vlv 1991-93 VIN L 1991-1993	HG 420-5R 1991-1993 Right Hand 9536 ----- HG 420-6L 1991-1993 Left Hand 9535 Head Bolts HB 420-5 1991-1993 72849	HK 420-5 1991-1993 Int. Man. N/I 9830	HS 420-5 1991-1993 Int. Man. N/I 9830	KS 420-5 1991-1993 Int. Man. N/I 9830	ER 420-5 1991-1993 Int. Man. N/I 9830
--	--	--	--	--	--

Chrysler, Dodge, Plymouth, & Eagle Cars: V8

4.5L 273 OHV V8 Chrysler Engine, 16 Vlv 1964-69 VIN D 1966-1969	HG 405-5 1964-1969 8553	HK 405-7 1964-1969 8553-9	HS 405-7 1964-1969 8553-9	KS 405-3 1964-1969 8553-9	ER 405-3 1964-1969 8553-9
5.2L 318 OHV V8 Chrysler Engine, 16 Vlv 5 BOLT VC 1957-89 VIN F 1967-1969 VIN G 1970-1980 VIN H 1978-1980 VIN J, K, L, M 1981-1982 VIN N 1981-1983 VIN P, S, 4 1983-1989 VIN R 1983-1985 VIN Z 1983-1988	HG 405-5 1967-1989 8553	HK 405-7 1967-1989 8553-9	HS 405-7 1967-1989 8553-9	KS 405-3 1967-1978 8553-9 ----- KS 405-4 1976-1978 2 & 4 Bbl. Carb HP & HD ENG. 1981-1983 w/TBI 1979-1989 2 & 4 Bbl. Carb 8553-8 ----- KS 405-5 1981-1989 8553-9	ER 405-3 1967-1978 8553-9 ----- ER 405-4 1976-1978 2 & 4 Bbl. Carb HP & HD ENG. 1981-1983 w/TBI 1979-1989 2 & 4 Bbl. Carb 8553-14 ----- ER 405-5 1981-1989 8553-14
5.6L 340 OHV V8 Chrysler Engine, 16 Vlv 1968-73 VIN H 1970-1973 VIN J 1970-1971 VIN P 1968-1969	HG 405-5 1968-1973 8553	HK 405-7 1968-1973 8553-9	HS 405-7 1968-1973 8553-9	KS 405-3 1968-1973 8553-9	ER 405-3 1968-1973 8553-9

OIL PAN SET	INTAKE MANIFOLD SET	EXHAUST MANIFOLD SET	VALVE COVER SET	TIMING COVER SET	REAR SEAL SET	VALVE STEM SEAL SET
-------------	---------------------	----------------------	-----------------	------------------	---------------	---------------------

Chrysler, Dodge, Plymouth, & Eagle Cars: 6 Cyl

OP 420-5 1991-1993 30622	VP 420-5 1991-1993 Upper & Lower 96042 ----- MS 420-4 1991-1993 Upper Set 94566	EMS 420-2 1991-1993 94666	VS 420-2 1991-1993 50339	TCS 420-2 1991-1993 Use w/OP 45893-1	RS 408-5 1991-1993 Radial 40168-1 ----- RS408-8 1991-1993 Radial 40627	SS 420-5 1991-1993 72783
--------------------------------	---	---------------------------------	--------------------------------	---	--	--------------------------------

Chrysler, Dodge, Plymouth, & Eagle Cars: V8

OP 405-1 1964-1969 6566-1	MS 405-2 1964-1965 9935 ----- MS 405-3 1966-1969 90009	EMS 405-3 1964-1969 9939	VS 405-5 1964-1969 13395	TCS 405-3 1964-1969 6563-1	RS 405-8 1964-1969 40245	SS 405-5 1967-1971 Int & Exh 13955
OP 405-0 1957-1966 6566 ----- OP 405-1 1967-1969 6566-1 ----- OP 405-2 1968-1978 6566-2	MS 405-1 1957-1966 2 Bolt VC Eng 9344 ----- MS 405-3 1967-1989 2 Bbl. Carb 90009 ----- MS 405-6 1978-1989 4 Bbl. Carb 1981-1983 w/ TBI 90109	EMS 405-2 1957-1966 9342 ----- EMS 405-3 1967-1974 9939 ----- EMS 405-5 1975-1989 90460	VS 405-2 1957-1966 2 Bolt VC w/Grommets 11828 ----- VS 405-3 1967-1989 13395 ----- VS 405-8 1976-1989 HP & HD High Temp 50184	TCS 405-3 1957-1989 6563-1	RS 405-8 1957-1989 40245	SS 405-5 1957-1971 Int & Exh 13955 ----- SS 405-6 1972-1989 Int & Exh 70014
OP 405-2 1968-1973 6566-2	MS 405-3 1968-1973 2 Bbl. Carb 90009 ----- MS 405-6 1968-1973 4 Bbl. Carb 90109	EMS 405-3 1968-1973 9939	VS 405-3 1968-1973 13395	TCS 405-3 1968-1973 6563-1	RS 405-8 1968-1973 40245	SS 405-5 1968-1973 Int & Exh 13955



ENGINE INFORMATION	HEAD GASKET	HEAD KIT With <u>NO</u> Valve Stem Seals	HEAD SET With Valve Stem Seals	KIT SET	SHORT BLOCK SET
--------------------	-------------	--	--------------------------------------	---------	-----------------

Chrysler, Dodge, Plymouth, & Eagle Cars: V8

5.7L 345 HEMI V8 HEMI Chrysler Engine, 16 Vlv 2005-2008 VIN H 2005-2008 Replacement of Head Bolts Required	HG 416-2R Right Side 2005-2007 26286 ----- HG 416-4L Left Side 2005-2007 26284 Head Bolts HB 416-5 2005-2007 72200	HK 416-2 2005-2006 26284 ----- HK 416-4 2007 26284-1	HS 416-2 2005-2006 26284 ----- HS 416-4 2007 26284-1	KS 416-2 2005-2006 26284 ----- KS 416-4 2007 26284-1	ER 416-2 2005-2006 26284 ----- ER 416-4 2007 26284-1
5.9L 360 OHV V8 Chrysler Engine, 16 Vlv 1971-80 VIN J 1974-1980 VIN K 1971-1980 VIN L 1974-1980	HG 405-5 1971-1980 8553	HK 405-7 1971-1980 8553-9/13	HS 405-7 1971-1980 8553-9/13	KS 405-6 1971-1980 8553-10	ER 405-6 1971-1980 8553-10
5.9L 361 OHV V8 Chrysler Engine, 16 Vlv 1958-66	HG 406-3 1958-1966 8519-1	HK 406-3 1958-1966 Valley Pan N/I 7891-11	HS 406-3 1958-1966 Valley Pan N/I 7891-11	KS 406-3 1958-1966 Valley Pan N/I 7891-11	ER 406-3 1958-1966 Valley Pan N/I 7891-11
6.3L 383 OHV V8 Chrysler Engine, 16 Vlv 1959-71 VIN G 1966-1969 VIN H 1967-1969 VIN L, N 1970-1971	HG 406-3 1959-1971 8519-1	HK 406-3 1959-1971 Valley Pan N/I 7891-11	HS 406-3 1959-1971 Valley Pan N/I 7891-11	KS 406-3 1959-1971 Valley Pan N/I 7891-11	ER 406-3 1959-1971 Valley Pan N/I 7891-11
6.6L 400 OHV V8 Chrysler Engine, 16 Vlv 1972-78 VIN M 1972-1976 VIN N 1974-1978 VIN P 1972-1978	HG 406-3 1972-1978 8519-1	HK 406-3 1972-1978 Valley Pan N/I 7891-11	HS 406-3 1972-1978 Valley Pan N/I 7891-11	KS 406-3 1972-1978 Valley Pan N/I 7891-11	ER 406-3 1972-1978 Valley Pan N/I 7891-11
6.7L 413 OHV V8 Chrysler Engine, 16 Vlv 1959-65	HG 406-3 1959-1965 8519-1	HK 406-3 1959-1965 Valley Pan N/I 7891-11	HS 406-3 1959-1965 Valley Pan N/I 7891-11	KS 406-3 1959-1965 Valley Pan N/I 7891-11	ER 406-3 1959-1965 Valley Pan N/I 7891-11



OIL PAN SET	INTAKE MANIFOLD SET	EXHAUST MANIFOLD SET	VALVE COVER SET	TIMING COVER SET	REAR SEAL SET	VALVE STEM SEAL SET
-------------	---------------------	----------------------	-----------------	------------------	---------------	---------------------

Chrysler, Dodge, Plymouth, & Eagle Cars: V8

OP 416-2 2005-2007 30761	MS 416-2 2005-2007 96574	EMS 416-2 2005-2006 96532 ----- EMS 416-4 2007 96905	VS 416-2 2005-2007 w/Spark Plug Seals 50625	TCS 416-2 2005-2007 46049	RS 416-2 2005-2007 40684	SS 416-2 2005-2007 72914
OP 405-3 1971-1980 6566-3	MS 405-3 1971-1980 2 Bbl. Carb 90009 ----- MS 405-6 1971-1980 4 Bbl. Carb 90109	EMS 405-3 1967-1974 9939 ----- EMS 405-5 1975-1978 90460	VS 405-3 1971-1980 13395	TCS 405-3 1971-1980 6563-1	RS 405-6 1971-1980 40094	SS 405-6 1971-1980 Int & Exh 70014
OP 406-3 1958-1966 11729-1 ----- OP-406-5 1958-1966 1 pc Silicone	VP 406-5 1958-1966 90175	EMS 406-3 1958-1966 90029	VS 406-3 1958-1966 13379	TCS 406-5 1958-1966 12460-2	RS 404-5 1958-1966 40240	SS 406-5 1958-1966 12419X2
OP 406-3 1959-1971 11729-1 ----- OP-406-5 1959-1971 1 pc Silicone	VP 406-5 1959-1971 90175	EMS 406-3 1959-1971 90029	VS 406-3 1959-1971 13379	TCS 406-5 1959-1971 12460-2	RS 404-5 1959-1971 40240	SS 406-5 1959-1971 12419X2
OP 406-3 1972-1978 11729-1 ----- OP-406-5 1973-1976 1 pc Silicone	VP 406-5 1972-1978 90175	EMS 406-3 1972-1978 90029	VS 406-3 1972-1978 13379	TCS 406-5 1972-1978 12460-2	RS 404-5 1972-1978 40240	SS 406-5 1972-1978 12419X2
OP 406-3 1959-1965 11729-1 ----- OP-406-5 1959-1965 1 pc Silicone	VP 406-3 1959-1965 96000	EMS 406-3 1959-1965 90029	VS 406-3 1959-1965 13379	TCS 406-5 1959-1965 12460-2	RS 404-5 1959-1965 40240	SS 406-5 1959-1965 12419X2



ENGINE INFORMATION	HEAD GASKET	HEAD KIT With <u>NO</u> Valve Stem Seals	HEAD SET With Valve Stem Seals	KIT SET	SHORT BLOCK SET
--------------------	-------------	--	--------------------------------------	---------	-----------------

Chrysler, Dodge, Plymouth, & Eagle Cars: V8

7.0L 426 OHV V8 Chrysler Engine, 16 Vlv 1963-71 VIN H 1966 VIN J 1967-1970 VIN R 1967, 1970-1971	HG 406-3 1963-1971 8519-1	HK 406-3 1963-1971 Valley Pan N/I 7891-11	HS 406-3 1963-1971 Valley Pan N/I 7891-11	KS 406-3 1963-1971 Valley Pan N/I 7891-11	ER 406-3 1963-1971 Valley Pan N/I 7891-11
7.2L 440 OHV V8 Chrysler Engine, 16 Vlv 1966-78 VIN K 1966-1969 VIN L 1966-1969 VIN M 1969 VIN T, U 1970-1978 VIN V 1970-1972	HG 406-3 1966-1978 8519-1	HK 406-5 1966-1978 Valley Pan N/I	HS 406-5 1966-1978 Valley Pan N/I	KS 406-5 1966-1978 Valley Pan N/I	ER 406-5 1966-1978 Valley Pan N/I

Dodge Truck, Mini-vans, & SUVs: 4 Cyl

1.7L 105 1715cc SOHC L4 Audi G54B Engine 1982-83 VIN A 1982-1983 VIN B 1983	HG 403-5 1982-1983 21200-1	HK 403-5 1982-1983 21200-3	HS 403-5 1982-1983 21200-3	KS 403-5 1982-1983 21200-3	ER 403-5 1982-1983 21200-3
2.0L 121.7 1995cc SOHC L4 Mitsubishi G52B/4G52 Engine, 8 Vlv 1979-82 VIN U 1979-1980 VIN 5 1981-1982	HG 409-4 1979-1980 8649 ----- HG 409-6 1981-1982 8788	HK 409-5 1979-1982 8649-1 ----- HK 409-6 1981-1982 8788	HS 409-5 1979-1982 8649-1 ----- HS 409-6 1981-1982 8788	KS 409-5 1979-1982 8649-1 ----- KS 409-6 1981-1982 8788	ER 409-5 1979-1982 8649-1 ----- ER 409-6 1981-1982 8788

OIL PAN SET	INTAKE MANIFOLD SET	EXHAUST MANIFOLD SET	VALVE COVER SET	TIMING COVER SET	REAR SEAL SET	VALVE STEM SEAL SET
-------------	---------------------	----------------------	-----------------	------------------	---------------	---------------------

Chrysler, Dodge, Plymouth, & Eagle Cars: V8

OP 406-3 1963-1971 11729-1 ----- OP-406-5 1963-1971 1 pc Silicone	VP406-3 1963-1971 96000	EMS 406-3 1963-1971 90029	VS 406-3 1963-1971 13379	TCS 406-5 1963-1971 12460-2	RS404-5 1963-1971 40240	SS 406-5 1963-1971 12419X2
OP 406-3 1966-1978 11729-1 ----- OP-406-5 1966-1975 1 pc Silicone	VP 406-3 1966-1978 96000	EMS 406-3 1966-1978 90029	VS 406-3 1966-1978 13379	TCS 406-5 1966-1978 12460-2	RS 404-5 1966-1978 40240	SS 406-5 1966-1978 12419X2

Dodge Truck, Mini-vans, & SUVs: 4 Cyl

OP 403-5 1982-1983 20101	MS 403-5 1982-1983 90403	USE MS	VS 403-5 1982-1983 w/Semi Circular Plug 50107	TCS 403-5 1982-1983 Cam Frt Seal Set 45357 ----- TCS 403-3 1982-1983 Aux Shaft Seal 45288 ----- TCS 403-5 1982-1983 Crk Frt Seal Set 24551	RS 403-5 1982-1983 40427	SS 403-5 1982-1983 72567
OP 407-5 1979-1982 30400	MS 409-4 1979-1980 22811 ----- MS 409-5 1981-1982 91060	EMS 409-4 1979-1980 22812 ----- EMS 407-5 1981-1982 90995	VS 407-5 1979-1982 w/Grommets & Semi-Circular Plug 50139	TCS 407-5 1979-1982 Crk Frt Seal Set 45170	RS 407-5 1979-1982 Radial 40408-1	SS 402-5 1979-1982 70702 ----- SS 407-6 1979-1982 Auxiliary 72681



ENGINE INFORMATION	HEAD GASKET	HEAD KIT With <u>NO</u> Valve Stem Seals	HEAD SET With Valve Stem Seals	KIT SET	SHORT BLOCK SET
--------------------	-------------	--	--------------------------------------	---------	-----------------

Dodge Truck, Mini-vans, & SUVs: 4 Cyl

<p>2.0L 122 DOHC L4 Chrysler A588 Engine, 16 Vlv 2002-04</p> <p>VIN Y 2002-2004</p>	<p>HG 414-6 2002-2004 26206</p>	<p>HK 414-8 2002-2004 26206-1</p>	<p>HS 414-8 2002-2004 26206-1</p>	<p>KS 414-8 2002-2004 26206-1</p>	<p>ER 414-8 2002-2004 26206-1</p>
<p>2.0L 122 1997cc SOHC L4 Mitsubishi G63B Engine, 8 Vlv 1983-89</p> <p>VIN D 1984-1989 VIN 5 1983</p>	<p>HG 952-5 1983-1989 9086</p>	<p>HK 952-6 1983-1989 9086-2</p>	<p>HS 952-6 1983-1989 9086-2</p>	<p>KS 952-6 1983-1989 9086-2</p>	<p>ER 952-6 1983-1989 9086-2</p>
<p>2.2L 135 SOHC L4 Chrysler Engine, 8 Vlv 1982-88</p> <p>VIN B 1982 VIN C 1983-1988 VIN D 1987</p>	<p>HG 408-5 1982-1988 9296</p> <p>Head Bolts HB 408-5 1982-1985 10 mm 72116 ----- HB 408-6 1985-1988 11 mm 72723</p>	<p>HK 408-5 1982-1988 4 Pc. VC 9296-2</p>	<p>HS 408-5 1982-1988 4 Pc. VC 9296-2</p>	<p>KS 408-5 1982-1988 4 Pc. VC 9296-2</p>	<p>ER 408-5 1982-1988 4 Pc. VC 9296-2</p>



OIL PAN SET	INTAKE MANIFOLD SET	EXHAUST MANIFOLD SET	VALVE COVER SET	TIMING COVER SET	REAR SEAL SET	VALVE STEM SEAL SET
-------------	---------------------	----------------------	-----------------	------------------	---------------	---------------------

Dodge Truck, Mini-vans, & SUVs: 4 Cyl

<p>OP 428-8 2002-2004 30673</p>	<p>MS 428-8 2002-2004 93219</p>	<p>EMS 428-4 2002-2004 92846</p>	<p>VS 414-8 2002-2004 w/Spark Plug Seals 50518 ----- Spark Plug Seals SPS-414-4 2002-2004 4 Per Pkg.</p>	<p>TCS 411-4 2002-2004 Cam Frt Seal 2 Required 45961 ----- TCS 411-5 2002-2004 Crk Frt Seal Set 45062</p>	<p>RS 411-5 2002-2004 Radial 40182 ----- RS 408-8 2002-2004 Radial PTFE 40627</p>	<p>SS 414-5 2002-2004 72871</p>
<p>OP 952-5 1983-1989 30460</p>	<p>MS 952-5 1983-1989 91657</p>	<p>EMS 952-5 1983-1989 92029</p>	<p>VS 908-5 1983-1989 w/Grommets & Semi-Circular Plug 50132</p>	<p>TCS 952-5 1983-1989 Cam Frt Seal Set 45483 ----- TCS 952-6 1983-1989 Crk Frt Seal Set Use w/ OP 45565-1</p>	<p>RS 407-5 1983-1989 Radial 40408-1</p>	<p>SS 408-5 1983-1989 72522</p>
<p>OP 408-5 1982-1988 30422</p>	<p>MS 408-5 1982-1988 90947</p>	<p>EMS USE MS</p>	<p>VS 408-5 1982-1988 50205</p>	<p>TCS 408-2 1982-1988 Cam Frt & Rear 53.59mm Rear 45691 ----- TCS 408-3 1982-1988 Cam Frt & Rear 52.45mm Rear 45690 ----- TCS 408-4 1982-1988 Cam Rear Seal 52.45mm Rear Yellow Stripe 45699 ----- TCS 408-6 1982-1988 Cam Rear Seal 53.59mm Rear White Stripe 45700 ----- TCS 408-5 1982-1988 Crk Frt Seal Set 1984-1990 Cam Frt Seal Set 45495</p>	<p>RS 408-5 1982-1988 Radial 40168-1 ----- RS 408-8 1982-1988 Radial PTFE 40627</p>	<p>SS 408-5 1982-1988 72522</p>



ENGINE INFORMATION	HEAD GASKET	HEAD KIT With <u>NO</u> Valve Stem Seals	HEAD SET With Valve Stem Seals	KIT SET	SHORT BLOCK SET
--------------------	-------------	--	--------------------------------------	---------	-----------------

Dodge Truck, Mini-vans, & SUVs: 4 Cyl

2.3L 143 2346cc SOHC Turbo Diesel L4 Mitsubishi 4G52 Engine 1983-86 VIN J 1984-1986 VIN 9 1983	HG 977-5 1983-1986 9084	HK 977-5 1983-1986 9084-1	HS 977-5 1983-1986 9084-1	KS 977-5 1983-1986 9084-1	ER 977-5 1983-1986 9084-1
2.4L 143.4 2351cc SOHC L4 Mitsubishi 4G64 Engine, 8 Vlv 1990-93 VIN G 1993 VIN W 1990-1992	HG 952-8 1990-1993 9388	HK 952-7 1990-1992 9388 ----- HK 952-9 1993 9388-3	HS 952-7 1990-1992 9388 ----- HS 952-9 1993 9388-3	KS 952-7 1990-1992 9388 ----- KS 952-9 1993 9388-3	ER 952-7 1990-1992 9388 ----- ER 952-9 1993 9388-3
2.4L 148 DOHC L4 Chrysler Engine, 16 Vlv 1996-06 VIN B 1996-2006	HG 428-4 1996-2001 Exc PT Cruiser 9924 ----- HG 428-5 1996-2001 Exc PT Cruiser .010 Thicker 26502 ----- HG 428-7 2001 PT Cruiser 9946 ----- HG 428-6 2002-2004 26206 ----- HG 428-8 2005-2006 26202 Head Bolts HB 428-5 1996-2006 71028	HK 428-4 1996-2000 9924 ----- HK 428-5 2001 Exc PT Cruiser 9924-2 ----- HK 428-7 2001 PT Cruiser 9946 ----- HK 428-9 2002-2004 PT Cruiser 26206-1 ----- HK 428-10 2002-2004 Exc PT Cruiser 26206-2 ----- HK 428-11 2005-2006 Exc PT Cruiser 26202-2 ----- HK 428-12 2005-2006 PT Cruiser 26202-3	HS 428-4 1996-2000 9924 ----- HS 428-5 2001 Exc PT Cruiser 9924-2 ----- HS 428-7 2001 PT Cruiser 9946 ----- HS 428-9 2002-2004 PT Cruiser 26206-1 ----- HS 428-10 2002-2004 Exc PT Cruiser 26206-2 ----- HS 428-11 2005-2006 Exc PT Cruiser 26202-2 ----- HS 428-12 2005-2006 PT Cruiser 26202-3	KS 428-4 1996-2000 9924 ----- KS 428-5 2001 Exc PT Cruiser 9924-2 ----- KS 428-7 2001 PT Cruiser 9946 ----- KS 428-9 2002-2004 PT Cruiser 26206-1 ----- KS 428-10 2002-2004 Exc PT Cruiser 26206-2 ----- KS 428-11 2005-2006 Exc PT Cruiser 26202-2 ----- KS 428-12 2005-2006 PT Cruiser 26202-3	ER 428-4 1996-2000 9924 ----- ER 428-5 2001 Exc PT Cruiser 9924-2 ----- ER 428-7 2001 PT Cruiser 9946 ----- ER 428-9 2002-2004 PT Cruiser 26206-1 ----- ER 428-10 2002-2004 Exc PT Cruiser 26206-2 ----- ER 428-11 2005-2006 Exc PT Cruiser 26202-2 ----- ER 428-12 2005-2006 PT Cruiser 26202-3



OIL PAN SET	INTAKE MANIFOLD SET	EXHAUST MANIFOLD SET	VALVE COVER SET	TIMING COVER SET	REAR SEAL SET	VALVE STEM SEAL SET
-------------	---------------------	----------------------	-----------------	------------------	---------------	---------------------

Dodge Truck, Mini-vans, & SUVs: 4 Cyl

<p>OP 407-5 1983-1986 30400</p>	<p>MS 977-5 1983-1986 91719-1</p>	<p>EMS USE MS</p>	<p>VS 977-5 1983-1986 50100</p>	<p>TCS 977-5 1983-1986 Cam Frt Seal Set 45483 ----- TCS 977-6 1983-1986 Crk Frt Seal Set 45464-1</p>	<p>RS 977-5 1983-1986 Radial 40444</p>	<p>SS 402-5 1983-1986 70702</p>
<p>OP 952-5 1990-1992 30460 ----- OP 952-7 1993 30665</p>	<p>MS 952-7 1990-1993 Upper & Lower Set 92964-3</p>	<p>EMS 952-5 1990-1992 92029 ----- EMS 952-7 1993 94841</p>	<p>VS 908-5 1990-1993 w/Grommets & Semi-Circular Plug 50132</p>	<p>TCS 977-5 1990-1993 Cam Frt Seal Set 45483 ----- TCS 977-6 1990-1992 Crk Frt Seal Set Use w/OP 45464-1 ----- TCS 977-7 1993 Crk Frt Seal Set Use w/OP 45946</p>	<p>RS 407-5 1990-1992 Radial 40408-1 ----- RS 910-5 1993 Radial 40648</p>	<p>SS 403-6 1990-1992 72630 ----- SS 407-5 1993 70598 ----- SS 407-6 1990-1992 Auxiliary 72681</p>
<p>OP 428-5 1996-2006 Exc PT Cruiser 30676 ----- OP 428-7 2001-2002 PT Cruiser 30701 ----- OP 428-8 2003-2006 PT Cruiser 30728</p>	<p>MS 428-5 1996-2000 95660 ----- MS 428-7 2001-2006 Exc. PT Cruiser 92532 ----- MS 428-8 2001-2006 PT Cruiser 93219 ----- MS 428-6 2006-2007 PT Cruiser 92888</p>	<p>EMS 428-2 1996-2000 95692 ----- EMS 428-4 2001-2006 92846</p>	<p>VS 428-4 1996-2006 w/Spark Plug Seals Exc. PT Cruiser 50459 ----- VS 428-5 2001-2006 w/Spark Plug Seals PT Cruiser 50518</p>	<p>TCS 411-4 1996-2006 Cam Frt Seal 2 Required 45961 ----- TCS 411-5 1996-2006 Crk Frt Seal Set 45962</p>	<p>RS 411-5 1996-2006 Radial 40182 ----- RS 408-8 1996-2006 Radial PTFE 40627</p>	<p>SS 414-5 1996-2006 72871</p>



ENGINE INFORMATION	HEAD GASKET	HEAD KIT With <u>NO</u> Valve Stem Seals	HEAD SET With Valve Stem Seals	KIT SET	SHORT BLOCK SET
--------------------	-------------	--	--------------------------------------	---------	-----------------

Dodge Truck, Mini-vans, & SUVs: 4 Cyl

2.4L 148 DOHC Turbo L4 Chrysler Engine, 16 Vlv 2003-06 VIN E 2006 VIN G 2003-2006	HG 428-8 2003-2006 26202 Head Bolts HB 428-5 2003-2006 71028	HK 428-8 2003-2006 26202	HS 428-8 2003-2006 26202	KS 428-8 2003-2006 26202	ER 428-8 2003-2006 26202
2.5L 150 OHV L4 AMC Engine, 8 Vlv 1996-02 VIN P 1996-2002	HG 083-0 1996-2002 9196	HK 083-0 1996 9196-1 ----- HK 083-6 1997-2002 9196-5	HS 083-0 1996 9196-1 ----- HS 083-6 1997-2002 9196-5	KS 083-0 1996 9196-1 ----- KS 083-6 1997-2002 9196-5	ER 083-0 1996 9196-1 ----- ER 083-6 1997-2002 9196-5



OIL PAN SET	INTAKE MANIFOLD SET	EXHAUST MANIFOLD SET	VALVE COVER SET	TIMING COVER SET	REAR SEAL SET	VALVE STEM SEAL SET
-------------	---------------------	----------------------	-----------------	------------------	---------------	---------------------

Dodge Truck, Mini-vans, & SUVs: 4 Cyl

OP 428-8 2003-2006 30728	MS 428-9 2003-2006 96198	EMS 428-4 2003-2006 92846	VS 428-4 2003-2006 w/Spark Plug Seals 50459	TCS 411-4 2003-2006 Cam Frt Seal 2 Required 45961 ----- TCS 411-5 2003-2006 Crk Frt Seal Set 45962	RS 411-5 2003-2006 Radial 40182 ----- RS 408-8 2003-2006 Radial PTFE 40627	SS 414-5 2003-2006 72871
OP 083-4 1996-2002 34007	MS 083-0 1996-2002 92100	EMS USE MS	VS 083-0 1996 50430 ----- VS 083-2 1997-2002 50502	TCS 082-5 1996-2002 45117	RS 312-5 1996-2002 Radial 40578	SS 083-5 1996-2002 72854



ENGINE INFORMATION	HEAD GASKET	HEAD KIT With <u>NO</u> Valve Stem Seals	HEAD SET With Valve Stem Seals	KIT SET	SHORT BLOCK SET
--------------------	-------------	--	--------------------------------------	---------	-----------------

Dodge Truck, Mini-vans, & SUVs: 4 Cyl

<p>2.5L 153 SOHC L4 Chrysler Engine, 8 Vlv 1987-95</p> <p>VIN G 1989-1995 VIN K 1987-199592</p> <p>HEAD BOLTS RECOMMENDED</p>	<p>HG 408-6 1987-1995 9296</p> <p>Head Bolts HB 408-6 1987-1995 w/Washers 72723/72176</p>	<p>HK 408-5 1987-1990 w/4 Pc. VC 1991-1995 w/Steel VC 9296-2 -----</p> <p>HK 408-10 1989-1990 w/1 Pc. VC 1991-1995 w/Aluminum VC 9296-3</p>	<p>HS 408-5 1987-1990 w/4 Pc. VC 1991-1995 w/Steel VC 9296-2 -----</p> <p>HS 408-10 1989-1990 w/1 Pc. VC 1991-1995 w/Aluminum VC 9296-3</p>	<p>KS 408-7 1987-1990 w/4 Pc. VC 1991-1995 w/Steel VC 9296-2 -----</p> <p>KS 408-10 1989-1990 w/1 Pc. VC 1991-1995 w/Aluminum VC 9296-3</p>	<p>ER 408-7 1987-1990 w/4 Pc. VC 1991-1995 w/Steel VC 9296-2 -----</p> <p>ER 408-10 1989-1990 w/1 Pc. VC 1991-1995 w/Aluminum VC 9296-3</p>
---	---	---	---	---	---



OIL PAN SET	INTAKE MANIFOLD SET	EXHAUST MANIFOLD SET	VALVE COVER SET	TIMING COVER SET	REAR SEAL SET	VALVE STEM SEAL SET
-------------	---------------------	----------------------	-----------------	------------------	---------------	---------------------

Dodge Truck, Mini-vans, & SUVs: 4 Cyl

<p>OP 408-5 1987 30535 ----- OP 408-8 1988-1995 30612</p>	<p>MS 408-5 1987-1995 90947</p>	<p>EMS USE MS</p>	<p>VS 408-5 1987-1990 w/Steel VC 4 Pc. VC 50205 ----- VS 408-9 1989-1990 1 Pc. Rubber 50370 ----- VS 408-8 1991-1995 Aluminum VC 50334</p>	<p>TCS 408-2 1987-1988 Cam Frt. & Rear w/53.59 mm Rear Seal O.D. 45691 ----- TCS 408-3 1987-1988 Cam Frt. & Rear w/52.45 mm Rear Seal O.D. 45690 ----- TCS 408-5 1987-1988 Cam Front Seal 45495 ----- TCS 408-4 1987-1988 Cam Rear Seal 52.45 O.D. 45699 ----- TCS 408-6 1987-1988 Cam Rear Seal 53.59 O.D. 45700 ----- TCS 408-7 1987-1995 Crank Front 45131 ----- TCS 408-8 1987-1995 Cam Rear Seal Plug Set 45833 ----- TCS 408-9 1987-1995 Auxiliary Seal 45026</p>	<p>RS 408-5 1987-1995 Radial 40168-1 ----- RS 408-8 1987-1995 Radial PTFE 40627</p>	<p>SS 408-5 1987-1995 72522</p>
---	---	-----------------------	--	---	---	---



ENGINE INFORMATION	HEAD GASKET	HEAD KIT With <u>NO</u> Valve Stem Seals	HEAD SET With Valve Stem Seals	KIT SET	SHORT BLOCK SET
--------------------	-------------	--	--------------------------------------	---------	-----------------

Dodge Truck, Mini-vans, & SUVs: 4 Cyl

<p>2.5L 153 SOHC Turbo L4 Chrysler Engine, 8 Vlv 1989-90</p> <p>VIN J 1989-1990</p> <p>HEAD BOLTS RECOMMENDED</p>	<p>HG 408-6 1989-1990 9296</p> <p>Head Bolts HB 408-7 1989-1990 w/Washers 72723/72176</p>	<p>HK 408-8 1989-1990 9296-1</p>	<p>HS 408-8 1989-1990 9296-1</p>	<p>KS 408-8 1989-1990 9296-1</p>	<p>ER 408-8 1989-1990 9296-1</p>
<p>2.6L 156 2555cc SOHC L4 Mitsubishi G54B Engine, 8 Vlv 1979-89</p> <p>VIN E 1984-1989 VIN G 1984-1987 VIN W 1979-1980 VIN 7 1981-1983</p>	<p>HG 407-2 1979-1980 8768 -----</p> <p>HG 407-5 1981-1989 8770</p>	<p>HK 407-2 1979-1980 8768 -----</p> <p>HK 407-5 1981-1989 RWD 8770-1 -----</p> <p>HK 407-8 1984-1987 FWD 8770</p>	<p>HS 407-2 1979-1980 8768 -----</p> <p>HS 407-5 1981-1989 RWD 8770-1 -----</p> <p>HS 407-8 1984-1987 FWD 8770</p>	<p>KS 407-2 1979-1980 8768 -----</p> <p>KS 407-5 1981-1989 RWD 8770-1 -----</p> <p>KS 407-8 1984-1987 FWD 8770</p>	<p>ER 407-2 1979-1980 8768 -----</p> <p>ER 407-5 1981-1989 RWD 8770-1 -----</p> <p>ER 407-8 1984-1987 FWD 8770</p>



OIL PAN SET	INTAKE MANIFOLD SET	EXHAUST MANIFOLD SET	VALVE COVER SET	TIMING COVER SET	REAR SEAL SET	VALVE STEM SEAL SET
-------------	---------------------	----------------------	-----------------	------------------	---------------	---------------------

Dodge Truck, Mini-vans, & SUVs: 4 Cyl

<p>OP 408-6 1989-1990 30612</p>	<p>MS 408-5 1989-1990 90947</p>	<p>EMS USE MS</p>	<p>VS 408-8 1989-1990 Aluminum VC 50334</p>	<p>TCS408-5 1989-1990 Cam Front Seal 45495 ----- TCS 408-7 1989-1990 Crank Front 45131 ----- TCS 408-8 1989-1990 Cam Rear Seal Plug Set 45833 ----- TCS 408-9 1989-1990 Auxiliary Seal 45026</p>	<p>RS 408-5 1989-1990 Radial 40168-1 ----- RS 408-8 1989-1990 Radial PTFE 40627</p>	<p>SS 408-5 1989-1990 72522</p>
<p>OP 407-5 1979-1989 30400</p>	<p>MS 407-5 1979-1980 22811 ----- MS 407-6 1981-1989 90981</p>	<p>EMS 409-4 1979-1980 22812 ----- EMS 407-5 1981-1989 90995</p>	<p>VS 407-5 1979-1980 w/Semi-Circular Plug & Grommets 50139 ----- VS 407-6 1981-1989 w/Semi-Circular Plug & Grommets 50146</p>	<p>TCS 407-5 1979-1989 Crk Frt Seal Set 45170 ----- TCS 407-6 1984-1987 FWD Cam Rear Seal 45847 ----- TCS 407-7 1981 To 6-30-83 RWD Cam Rear Plug 45849 ----- TCS 407-8 1983-1989 From 7-1-83 RWD Cam Rear Plug 45848</p>	<p>RS 407-5 1979-1989 Radial 40408-1</p>	<p>SS 407-5 1979-1989 70598 ----- SS 407-6 1979-1989 Aux. 72681</p>



ENGINE INFORMATION	HEAD GASKET	HEAD KIT With <u>NO</u> Valve Stem Seals	HEAD SET With Valve Stem Seals	KIT SET	SHORT BLOCK SET
--------------------	-------------	--	--------------------------------------	---------	-----------------

Dodge Truck, Mini-vans, & SUVs: 6 Cyl

2.8L 170 OHV L6 Chrysler Engine, 12 Vlv 1961-69 VIN A 1966-1969 VIN 6 1968-1969	HG 404-5 1961-1969 7918-1	HK 404-5 1961-1969 7918-4	HS 404-5 1961-1969 7918-4	KS 404-5 1961-1969 7918-4	ER 404-5 1961-1969 7918-4
3.0L 181.1 2972cc SOHC V6 Mitsubishi 6G72 Engine, 12 Vlv 1987-00 VIN 2 1989-1992 VIN 3 1987-2000 HEAD BOLTS RECOMMENDED	HG 410-2 1987-2000 9112 Head Bolts HB 426-5 1987-2000 72859	HK 410-2 1987-1998 9112 ----- HK 410-5 1999-2000 9112-3	HS 410-2 1987-1988 1989-1992 FWD 1993-1998 9112 ----- HS 410-4 1989-1992 RWD 9112-1 ----- HS 410-5 1999-2000 9112-3	KS 410-2 1987-1988 1989-1992 FWD 1993-1998 9112 ----- KS 410-4 1989-1992 RWD 9112-1 ----- KS 410-5 1999-2000 9112-3	ER 410-2 1987-1988 1989-1992 FWD 1993-1998 9112 ----- ER 410-4 1989-1992 RWD 9112-1 ----- ER 410-5 1999-2000 9112-3
3.2L 198 OHV L6 Chrysler Engine, 12 Vlv 1970-73 VIN A 1970-1973	HG 404-5 1970-1973 7918-1	HK 404-5 1970-1973 7918-4	HS 404-5 1970-1973 7918-4	KS 404-5 1970-1973 7918-4	ER 404-5 1970-1973 7918-4
3.3L 201 OHV V6 Chrysler Engine, 12 Vlv 1990-06 VIN G 1998-2001 (FLEX FUEL) VIN R 1990-2006 VIN S 2004 (FLEX FUEL) VIN U 1994-1996 (FLEX FUEL) VIN 3 2001-2005 (FLEX FUEL)	HG 420-2R 1990-2000 9673-1 ----- HG 420-4L 1990-2000 9676-1 ----- HG 420-3R 2001-2006 9978 ----- HG 420-8L 2001-2006 9981	HK 420-2 1990-1997 & 1998-2000 w/o Isolated Valve Covers Int Man N/I 9673 ----- HK 420-4 1998-2000 w/Isolated Valve Covers Int Man N/I 9673-1 ----- HK 420-11 2001-2004 Int Man N/I 9978 ----- HK 420-12 2005-2006 w/Plastic VC Int Man N/I 9978-1	HS 420-2 1990-1997 & 1998-2000 w/o Isolated Valve Covers Int Man N/I 9673 ----- HS 420-4 1998-2000 w/Isolated Valve Covers Int Man N/I 9673-1 ----- HS 420-11 2001-2004 Int Man N/I 9978 ----- HS 420-12 2005-2006 w/Plastic VC Int Man N/I 9978-1	KS 420-2 1990-1997 & 1998-2000 w/o Isolated Valve Covers Int Man N/I 9673 ----- KS 420-4 1998-2000 w/Isolated Valve Covers Int Man N/I 9673-1 ----- KS 420-11 2001-2004 Int Man N/I 9978 ----- KS 420-12 2005-2006 w/Plastic VC Int Man N/I 9978-1	ER N/A



OIL PAN SET	INTAKE MANIFOLD SET	EXHAUST MANIFOLD SET	VALVE COVER SET	TIMING COVER SET	REAR SEAL SET	VALVE STEM SEAL SET
-------------	---------------------	----------------------	-----------------	------------------	---------------	---------------------

Dodge Truck, Mini-vans, & SUVs: 6 Cyl

OP 404-5 1961-1969 12705-1	MS 404-5 1961-1969 9610-1	USE MS	VS 404-5 1961-1969 12680	TCS 404-5 1961-1969 12769-1	RS 404-5 1961-1969 40240	SS 404-5 1961-1969 13955/12764
OP 410-5 1987-2000 30570	MS 410-5 1987-1988 1989-1992 FWD 1993-2000 Upper & Lower 93795 ----- MS 410-4 1989-1992 Upper & Lower RWD 93795-2 ----- MS 410-8 1987-2000 Upper FWD 93796	EMS 410-5 1987-1998 93797 ----- EMS 410-4 1999 91815 ----- EMS 410-6 2000 91815-1	VS 410-5 1987-2000 w/Plugs & Grommets 50173	TCS 410-2 1987-2000 CAM 45483 ----- TCS 410-5 1987-2000 CRANK 45750 ----- TCS 410-3 1987-2000 Dust Seal 45835	RS 410-5 1987-2000 Radial 40562 ----- RS 408-8 1987-2000 Radial PTFE 40627	SS 410-5 1987-2000 70710
OP 404-5 1970-1973 12705-1	MS 404-5 1970-1973 9610-1	EMS USE MS	VS 404-5 1970-1973 12680	TCS 404-5 1970-1973 12769-1	RS 404-5 1970-1973 40240	SS 404-5 1970-1973 13955/12764
OP 420-5 1990-2006 30622	VP 420-5 1990-2000 Upper & Lower 96042 ----- MS 420-4 1990-2000 Upper Set 94566 ----- MS 420-8 2001-2006 Upper & Lower 92808-1 ----- MS 420-6 2001-2006 Upper Set 96176	EMS 420-2 1990-2006 94666	VS 420-2 1990-2000 w/o Isolated VC Use w/MS 420-4 50339 ----- VS 420-4 1998-2000 w/Isolated VC Use w/MS 420-4 50449 ----- VS 420-5 2001-2004 w/Grommets 50513 ----- VS 420-6 2005-2006 W/Plastic VC w/Grommets 50599	TCS 420-2 1990-2001 Use w/OP 420-5 45893-1 ----- TCS 420-4 2002-2006 Use w/OP 420-5 46023	RS 408-5 1990-2006 Radial 40168-1 ----- RS 408-8 1990-2006 Radial PTFE 40627	SS 420-2 1990-2000 72783 ----- SS 420-6 2001-2006 71035



ENGINE INFORMATION	HEAD GASKET	HEAD KIT With <u>NO</u> Valve Stem Seals	HEAD SET With Valve Stem Seals	KIT SET	SHORT BLOCK SET
--------------------	-------------	--	--------------------------------------	---------	-----------------

Dodge Truck, Mini-vans, & SUVs: 6 Cyl

<p>3.5L 215 SOHC V6 Chrysler Engine, 24 Vlv 2004-2006</p> <p>VIN 4 2004-2006</p> <p>HEAD BOLTS RECOMMENDED</p>	<p>HG 425-8R 2004-2006 Right Hand 26208 ----- HG 425-9L 2004-2006 Left Hand 26209</p> <p>Head Bolts HG 425-5 2 Required 72895</p>	<p>HK 425-6 2004-2006 26208-1</p>	<p>HS 425-6 2004-2006 26208-1</p>	<p>KS 425-6 2004-2006 26208-1</p>	<p>ER 425-6 2004-2006 26208-1</p>
<p>3.7L 225 OHV L6 Chrysler Engine, 12 Vlv 1960-87</p> <p>VIN B 1966-1980 VIN C 1970-1971 & 1974-1977 VIN E 1978 & 1981-1983 VIN H 1981-1987 VIN M 1983 VIN N 1979-1980 VIN W 1982 VIN X 1970-1979 VIN 6 1968-1970</p>	<p>HG 404-5 1960-1987 7918-1</p>	<p>HK 404-5 1960-1980 7918-4 ----- HK 404-6 1981-1987 7918-3</p>	<p>HS 404-5 1960-1980 7918-4 ----- HS 404-6 1981-1987 7918-3</p>	<p>KS 404-5 1960-1980 7918-4 ----- KS 404-6 1981-1987 7918-3</p>	<p>ER 404-5 1960-1980 7918-4 ----- ER 404-6 1981-1987 7918-3</p>
<p>3.7L 226 SOHC V6 Chrysler Engine, 24 Vlv EKG 2002-2006</p> <p>VIN K 2002-2006</p>	<p>HG 413-8 2002-2006 26229</p>	<p>HK 413-8 2002-2006 26229</p>	<p>HS 413-8 2002-2006 26229</p>	<p>KS 413-8 2002-2006 26229</p>	<p>ER 413-8 2002-2006 26229</p>



OIL PAN SET	INTAKE MANIFOLD SET	EXHAUST MANIFOLD SET	VALVE COVER SET	TIMING COVER SET	REAR SEAL SET	VALVE STEM SEAL SET
-------------	---------------------	----------------------	-----------------	------------------	---------------	---------------------

Dodge Truck, Mini-vans, & SUVs: 6 Cyl

<p>OP 425-6 2004 30733</p>	<p>MS 425-3 2004-2006 Upper & Lower 92165-1 ----- MS 425-4 2004-2006 Upper Set 96324</p>	<p>EMS 422-4 2004-2006 95446</p>	<p>VS 422-4 2004-2006 w/o Grommets w/o Spark Plug Seals 50501 -----</p>	<p>TCS 422-4 2004-2006 Cam Frt Set 2 Required 45939 ----- TCS 422-6 2004-2006 Crank Seal Set Use w/ Oil Pan 45992</p>	<p>RS 408-5 2004-2006 Radial 40168-1</p>	<p>SS 422-4 2004-2006 72842X2</p>
<p>OP 404-5 1960-1987 12705-1</p>	<p>MS 404-5 1960-1987 9610-1</p>	<p>USE MS</p>	<p>VS 404-5 1960-1987 1960-1980 ----- VS 404-6 1981-1987 50185</p>	<p>TCS 404-5 1960-1987 12769-1</p>	<p>RS 404-5 1960-1980 2 Pc. Rubber 40240 ----- RS 404-6 1981-1987 2 Pc. Rubber 40489</p>	<p>SS 404-5 1960-1980 Int & Exh 13955/12764 ----- SS 404-6 1981-1987 Int & Exh 12764/70537</p>
<p>OP 413-5 2002-2006 30743</p>	<p>MS 413-8 2002-2006 93205-1</p>	<p>EMS 413-5 2002-2006 96344</p>	<p>VS 413-8 2002-2004 w/Grommets 2005 w/Steel VC w/Grommets 50594</p>	<p>TCS 415-8 2002-2006 46022</p>	<p>RS 415-5 2002-2006 Radial 40186</p>	<p>SS 413-6 2002-2006 71041-1</p>



ENGINE INFORMATION	HEAD GASKET	HEAD KIT With <u>NO</u> Valve Stem Seals	HEAD SET With Valve Stem Seals	KIT SET	SHORT BLOCK SET
--------------------	-------------	--	--------------------------------------	---------	-----------------

Dodge Truck, Mini-vans, & SUVs: 6 Cyl

<p>3.8L 231 OHV V6 Chrysler Engine, 12 Vlv 1994-07</p> <p>VIN L 1994-2008 VIN P 2008</p>	<p>HG 420-7R 1994-2000 Right Side 9830/9836 -----</p> <p>HG 420-9L 1994-2000 Left Side 9829/9535 -----</p> <p>HG 420-10R 2001-2006 Right Side 9996 -----</p> <p>HG 420-12L 2001-2006 Left Side 9997</p>	<p>HK 420-5 1994-1997 & 1998-2000 w/o Isolated VC Int Man N/I 9830 -----</p> <p>HK 420-6 1998-2000 w/Isolated VC Int Man N/I 9535 -----</p> <p>HK 420-8 2001 Int Man N/I 9996 -----</p> <p>HK 420-9 2002-2003 & 2004 w/Steel Valve Covers Int Man N/I 9996-1 -----</p> <p>HK 420-10 2004 w/Plastic Valve Covers & 2005-2007 9996-2</p>	<p>HS 420-5 1994-1997 & 1998-2000 w/o Isolated VC Int Man N/I 9830 -----</p> <p>HS 420-6 1998-2000 w/Isolated VC Int Man N/I 9535 -----</p> <p>HS 420-8 2001 Int Man N/I 9996 -----</p> <p>HS 420-9 2002-2003 & 2004 w/Steel Valve Covers Int Man N/I 9996-1 -----</p> <p>HS 420-10 2004 w/Plastic Valve Covers & 2005-2007 9996-2</p>	<p>KS 420-5 1994-1997 & 1998-2000 w/o Isolated VC Int Man N/I 9830 -----</p> <p>KS 420-6 1998-2000 w/Isolated VC Int Man N/I 9535 -----</p> <p>KS 420-8 2001 Int Man N/I 9996 -----</p> <p>KS 420-9 2002-2003 & 2004 w/Steel Valve Covers Int Man N/I 9996-1 -----</p> <p>KS 420-10 2004 w/Plastic Valve Covers & 2005-2007 9996-2</p>	<p>ER N/A</p>
<p>3.9L 239 OHV V6 Chrysler Engine, 12 Vlv 1986-03</p> <p>VIN M 1986-1997 VIN X 1988-2003</p> <p>HEAD BOLTS RECOMMENDED</p>	<p>HG 412-2 1986-1991 9111 -----</p> <p>HG 412-4 1992-2003 9910</p> <p>Head Bolts HB 412-5 1998-2003 71038</p>	<p>HK 412-0 1986-1989 9111 -----</p> <p>HK 412-1 1990 9111-1 -----</p> <p>HK 412-2 1991 9111-2 -----</p> <p>HK 412-5 1992-1997 9910 -----</p> <p>HK 412-6 1998-2003 9910-1</p>	<p>HS 412-0 1986-1989 9111 -----</p> <p>HS 412-1 1990 9111-1 -----</p> <p>HS 412-2 1991 9111-2 -----</p> <p>HS 412-5 1992-1997 9910 -----</p> <p>HS 412-6 1998-2003 9910-1</p>	<p>KS 412-0 1986-1989 9111 -----</p> <p>KS 412-1 1990 9111-1 -----</p> <p>KS 412-2 1991 9111-2 -----</p> <p>KS 412-5 1992-1997 9910 -----</p> <p>KS 412-6 1998-2003 9910-1</p>	<p>ER 412-0 1986-1989 9111 -----</p> <p>ER 412-1 1990 9111-1 -----</p> <p>ER 412-2 1991 9111-2 -----</p> <p>ER 412-5 1992-1997 9910 -----</p> <p>ER 412-6 1998-2003 9910-1</p>

OIL PAN SET	INTAKE MANIFOLD SET	EXHAUST MANIFOLD SET	VALVE COVER SET	TIMING COVER SET	REAR SEAL SET	VALVE STEM SEAL SET
-------------	---------------------	----------------------	-----------------	------------------	---------------	---------------------

Dodge Truck, Mini-vans, & SUVs: 6 Cyl

<p>OP 420-5 1994-2007 30622</p>	<p>VP 420-5 1994-2000 Upper & Lower Set 96042 ----- VP 420-1 2001 Upper & Lower Set 92808 ----- VP 420-8 2002-2007 Upper & Lower Set 92808-1 ----- MS 420-4 1994-2000 Upper Set 94566 ----- MS 420-7 2001 Upper Set 92947 ----- MS 420-6 2002-2006 Upper Set 96176</p>	<p>EMS 420-2 1994-2006 94666</p>	<p>VS 420-2 1994-1997 & 1998-2000 w/o Isolated Valve Covers 9/32 Bolt Holes Use w/MS/VP 50339 ----- VS 420-3 1998-2000 w/Isolated Valve Covers 29/64" Bolt Holes Use w/MS/VP 50449 ----- VS 420-4 2001-2003 w/Grommets 2004 w/Steel VC 50513 ----- VS 420-5 2004-2006 w/Grommets Plastic VC 50599</p>	<p>TCS 420-2 1994-2001 Use w/Oil Pan 45893-1 ----- TCS 420-5 2002-2006 Use w/Oil Pan 46023</p>	<p>RS 408-5 1994-2006 Radial 40168-1</p>	<p>SS 420-2 1994-2000 72783 ----- SS 420-6 2001-2006 71035</p>
<p>OP 412-2 1986-1991 Cork/Rubber 30569 ----- OP 412-4 1992-2003 1 Pc. Silicone 34503</p>	<p>MS 412-2 1986-1991 93789 ----- MS 412-4 1992-1997 Upper & Lower 95315 ----- MS 412-5 1998-2003 Upper & Lower 95315-1</p>	<p>EMS 412-2 1986-1991 93791 ----- EMS 412-4 1992-2003 95463</p>	<p>VS 412-2 1986-1990 Cork/Rubber 50025 ----- VS 412-4 1991 Rubber 50436 ----- VS 412-5 1992-2003 Rubber 50420</p>	<p>TCS 412-2 1986-1991 45790 ----- TCS 405-5 1992-1996 Use w/OP 45952 ----- TCS 405-6 1997-2003 Use w/OP 45996</p>	<p>RS 405-8 1986-1991 2 Pc. 40245 ----- RS 405-9 1992-2003 2 Pc. 40181</p>	<p>SS 412-2 1986-1989 70014 ----- SS 412-5 1990-1991 72729 ----- SS 082-8 1992-2003 72835</p>



ENGINE INFORMATION	HEAD GASKET	HEAD KIT With <u>NO</u> Valve Stem Seals	HEAD SET With Valve Stem Seals	KIT SET	SHORT BLOCK SET
--------------------	-------------	--	--------------------------------------	---------	-----------------

Dodge Truck, Mini-vans, & SUVs: 6 Cyl

5.9L 359 OHV Turbo Diesel L6 Cummins Engine, 12 Vlv 1988-99 VIN C 1991-1996 VIN D 1997-1999 VIN 8 1988-1991 6BTA5.9	HG 459-5 1988-1996 Std. .061 Thick 9332 ----- HG 459-7 1994-1996 .071 Thick .25mm Oversize 9534 ----- HG 459-8 1994-1996 .081 Thick .50mm Oversize 9532 ----- HG 459-6 1997-1999 Vin D .061 Thick 9313	HKX 459-5 1988-1996 Head Gasket N/I 9332 ----- HK 459-4 1997 VIN D 9313 ----- HK 459-6 1998-1999 VIN D 9313-1	HSX 459-5 1988-1996 Head Gasket N/I 9332 ----- HS 459-4 1997 VIN D 9313 ----- HS 459-6 1998-1999 VIN D 9313-1	KSX 459-5 1988-1996 Head Gasket N/I 9332 ----- HS 459-4 1997 VIN D 9313 ----- HS 459-6 1998-1999 VIN D 9313-1	ER N/A
5.9L 359 OHV Turbo Diesel L6 Cummins Engine, 24 Vlv 1998-03 VIN C 2002-2006 (H.O.) VIN 6 1998-2005 VIN 7 1998-2004 6BTA5.9	HG 460-5 1998-2002 .061 Thick 9522	HK 460-5 1998-2002 9522	HS 460-5 1998-2002 9522	KS 460-5 1998-2002 9522	ER N/A

Dodge Truck, Mini-vans, & SUVs: V8

4.5L 273 OHV V8 Chrysler Engine, 16 Vlv 1964-68 VIN D 1964-1968	HG 405-5 1964-1968 8553	HK 405-7 1964-1968 8553-2,-9	HS 405-7 1964-1968 8553-2,-9	KS 405-3 1964-1968 8553-9	ER 405-3 1964-1968 8553-9
--	-------------------------------	------------------------------------	------------------------------------	---------------------------------	---------------------------------



OIL PAN SET	INTAKE MANIFOLD SET	EXHAUST MANIFOLD SET	VALVE COVER SET	TIMING COVER SET	REAR SEAL SET	VALVE STEM SEAL SET
-------------	---------------------	----------------------	-----------------	------------------	---------------	---------------------

Dodge Truck, Mini-vans, & SUVs: 6 Cyl

<p>OP 459-4 1988-1993 34102 ----- OP 459-5 1994-1999 Vin C,D 30694</p>	<p>MS 459-5 1988-1999 95087</p>	<p>EMS 459-5 1988-1999 92089</p>	<p>VS 459-4 1988-1997 6 Req'd 50396 ----- VS 459-5 1998-1999 6 Req'd Vin D 50505</p>	<p>TCS 459-4 1988-1993 45902 ----- TCS 459-5 1994-1999 Vin C, D 46001</p>	<p>RS 459-5 1988-1993 Radial PTFE 40633 ----- RS 459-6 1994-1999 Radial PTFE Vin C, D 40650</p>	<p>SS 459-5 1988-1999 70819-1</p>
<p>OP 459-5 1998-2002 30694 ----- OP 460-4 2003-2006 30738</p>	<p>MS 459-5 1998-2002 95087 ----- MS 460-4 2003-2006 96279</p>	<p>EMS 460-2 1998-2003 & 2004 To 1-3-04 92492 ----- EMS 460-4 2004 -2006 From 1-4-04 96677</p>	<p>VS 460-5 1998-2002 w/Grommets 50506</p>	<p>TCS 460-5 1998-2002 45994 ----- TCS 460-6 2003-2006 46031</p>	<p>RS 459-6 1998-2003 Radial PTFE 40650 ----- RS 460-5 2004-2006 Radial PTFE 40692</p>	<p>SS 460-5 1998-2002 70937</p>

Dodge Truck, Mini-vans, & SUVs: V8

<p>OP 405-1 1964-1968 6566-1</p>	<p>MS 405-2 1964-1965 9935 ----- MS 405-3 1966-1968 90009</p>	<p>EMS 405-3 1964-1968 9939</p>	<p>VS 405-3 1964-1968 13395</p>	<p>TCS 405-3 1964-1968 6563-1</p>	<p>RS 405-8 1964-1968 2 Pc. Rubber 40245</p>	<p>SS 405-5 1964-1968 13395X2</p>
--	---	---	---	---	--	---



ENGINE INFORMATION	HEAD GASKET	HEAD KIT With <u>NO</u> Valve Stem Seals	HEAD SET With Valve Stem Seals	KIT SET	SHORT BLOCK SET
--------------------	-------------	--	--------------------------------------	---------	-----------------

Dodge Truck, Mini-vans, & SUVs: V8

<p>4.7L 287 SOHC V8 Chrysler Engine, 16 Vlv 2000-08</p> <p>VIN J 2005-2007 H.O. VIN N 2000-2008 VIN P 2004-2008 FLEX FUEL</p> <p>HEAD BOLTS RECOMMENDED</p>	<p>HG 415-5 2000-2006 26157</p> <p>Head Bolts HB 415-5 2000-2006 71129</p>	<p>HK 415-5 2000-2003 26157 ----- HK 415-6 2004-2006 26157-1</p>	<p>HS 415-5 2000-2003 26157 ----- HS 415-6 2004-2006 26157-1</p>	<p>KS 415-5 2000-2003 26157 ----- KS 415-6 2004-2006 26157-1</p>	<p>ER 415-5 2000-2003 26157 ----- ER 415-6 2004-2006 26157-1</p>
<p>5.2L 318 OHV V8 Chrysler Engine, 16 Vlv 1967-03</p> <p>VIN E 1966-1980 VIN G 1971, 1974-1975 VIN P 1978-1982 VIN R 1981-1982 VIN T 1983-1987 VIN U 1983 VIN Y 1988-2003 VIN 8 1968-1969</p> <p>HEAD BOLTS RECOMMENDED</p>	<p>HG 405-5 1967-1990 8553 ----- HG 405-8 1991-2003 26179 -----</p> <p>Head Bolts HB 405-6 1994-2003 71038-1</p>	<p>HK 405-7 1967-1990 2 & 4 Bbl ----- HK 405-9 1991 26179 ----- HK 405-10 1992-1997 26179-1 ----- HK 405-13 1998-2003 26179-2</p>	<p>HS 405-7 1967-1990 2 & 4 Bbl 8553-12-13- 14-16 ----- HS 405-9 1991 26179 ----- HS 405-10 1992-1997 26179-1 ----- HS 405-13 1998-2003 26179-2</p>	<p>KS 405-3 1967-1981 8553-12 ----- KS 405-4 1976-1981 8553-8 ----- KS 405-5 1981-1990 LA ----- KS 405-9 1991 26179 ----- KS 405-10 1992-1997 26179-1 ----- KS 405-13 1998-2003 26179-2</p>	<p>ER 405-3 1967-1981 8553-12 ----- ER 405-4 1976-1981 8553-8 ----- ER 405-5 1981-1990 LA ----- ER 405-9 1991 26179 ----- ER 405-10 1992-1997 26179-1 ----- ER 405-13 1998-2003 26179-2</p>



OIL PAN SET	INTAKE MANIFOLD SET	EXHAUST MANIFOLD SET	VALVE COVER SET	TIMING COVER SET	REAR SEAL SET	VALVE STEM SEAL SET
-------------	---------------------	----------------------	-----------------	------------------	---------------	---------------------

Dodge Truck, Mini-vans, & SUVs: V8

<p>OP 415-5 2000-2007 30709</p>	<p>MS 415-5 2000-2007 93205</p>	<p>EMS 415-5 2000-2007 93217</p>	<p>VS 415-5 2000-2004 w/Grommets 50521 ----- VS 415-6 2005-2007 w/Grommets 50577</p>	<p>TCS 415-5 2000-2002 To 5-13-02 46000 ----- TCS 415-8 2002-2007 From 5-14-02 46022</p>	<p>RS 415-5 2000-2007 Radial 40186</p>	<p>SS 415-5 2000-2007 71041</p>
<p>OP 405-2 1967-1969 6566-1 ----- OP 405-3 1972-1991 6566-3 ----- OP 405-4 1992-2003 1 pc. Silicone 34408</p>	<p>MS 405-4 1967-1990 2 Bbl. 7/8 X 2 Int. Ports 90041-1 ----- MS 405-6 1967-1990 2 Bbl 1 X 2 3/16 Int. Ports 90109 ----- MS 405-8 1991 94964 ----- MS 405-10 1992-1997 Upper & Lower 95392 ----- MS 405-11 1998-2003 Upper & Lower 95392-1 ----- MS 405-14 1992-2003 Upper 95462</p>	<p>EMS 405-3 1968-1974 9939 ----- EMS 405-5 1974-1991 90460 ----- EMS 405-6 1992-2003 95480</p>	<p>VS 405-3 1968-1981 13395 ----- VS 405-8 1976-1991 HD & HP 50184 ----- VS 405-6 1992-2003 50419</p>	<p>TCS 405-3 1968-1991 6563-1 ----- TCS 405-5 1992-1996 45952 ----- TCS 405-6 1997-2003 45996</p>	<p>RS 405-8 1968-1991 40245 ----- RS 405-9 1992-2003 40181</p>	<p>SS 405-5 1968-1975 Early Style 13955 ----- SS 405-6 1968-1989 OEM 70014 ----- SS 405-7 1968-1989 OEM INT. 70537 ----- SS 405-8 1968-1989 OEM EXH. 12764 ----- SS 405-9 1990-1990 Int. & Exh. 72730 ----- SS 405-10 1992-2003 Int & Exh. 72844</p>



ENGINE INFORMATION	HEAD GASKET	HEAD KIT With <u>NO</u> Valve Stem Seals	HEAD SET With Valve Stem Seals	KIT SET	SHORT BLOCK SET
--------------------	-------------	--	--------------------------------------	---------	-----------------

Dodge Truck, Mini-vans, & SUVs: V8

<p>5.2L 318 OHV V8 CNG Chrysler Engine, 16 Vlv 1992-03</p> <p>VIN T 1992-2003</p>	<p>HG 405-8 1992-2003 26179</p>	<p>HK 405-10 1992-1997 26179-1 ----- HK 405-13 1998-2003 26179-2</p>	<p>HS 405-10 1992-1997 26179-1 ----- HS 405-13 1998-2003 26179-2</p>	<p>KS 405-10 1992-1997 26179-1 ----- KS 405-13 1998-2003 26179-2</p>	<p>ER 405-10 1992-1997 26179-1 ----- ER 405-13 1998-2003 26179-2</p>
<p>5.7L 345 HEMI V8 HEMI Chrysler Engine, 16 Vlv 2005-2008</p> <p>VIN D 2003-2008 VIN 6 2006-2008</p> <p>Replacement of Head Bolts Required</p>	<p>HG 416-2R Right Side 2003-2007 26286 ----- HG 416-4L Left Side 2003-2007 26284</p> <p>Head Bolts HB 416-5 2003-2007 72200</p>	<p>HK 416-2 2003-2006 26284 ----- HK 416-4 2007 26284-1</p>	<p>HS 416-2 2003-2006 26284 ----- HS 416-4 2007 26284-1</p>	<p>KS 416-2 2003-2006 26284 ----- KS 416-4 2007 26284-1</p>	<p>ER 416-2 2003-2006 26284 ----- ER 416-4 2007 26284-1</p>
<p>5.9L 360 OHV V8 Chrysler Engine, 16 Vlv 1972-03</p> <p>VIN F 1971-1980 VIN K 1975, 1978-1980 VIN L 1974-1975 VIN S 1979-1982 VIN T 1974-1982 VIN U 1981-1983 VIN V 1976-1985 VIN W 1983-1988 VIN Y 1971-1975 VIN Z 1989-2003 VIN 1 1983-1988 VIN 5 1986-2002</p> <p>HEAD BOLTS RECOMMENDED</p>	<p>HG 405-5 1967-1990 8553 ----- HG 405-8 1991-2003 26179 -----</p> <p>Head Bolts HB 405-6 1994-2003 71038-1</p>	<p>HK 405-7 1967-1990 2 & 4 Bbl ----- HK 405-9 1991 26179 ----- HK 405-10 1992-1997 26179-1 ----- HK 405-13 1998-2003 26179-2</p>	<p>HS 405-7 1967-1990 2 & 4 Bbl 8553-12-13- 14-16 ----- HS 405-9 1991 26179 ----- HS 405-10 1992-1997 26179-1 ----- HS 405-13 1998-2003 26179-2</p>	<p>KS 405-6 1972-1981 8553-13 ----- KS 405-8 1976-1989 8553-14 ----- KS 405-11 1990-1992 8553-15 ----- KS 405-12 1993-1997 9898-1 ----- KS 405-14 1998-2003 9898-2</p>	<p>ER 405-6 1972-1981 8553-13 ----- ER 405-8 1976-1989 8553-14 ----- ER 405-11 1990-1992 8553-15 ----- ER 405-12 1993-1997 9898-1 ----- ER 405-14 1998-2003 9898-2</p>



OIL PAN SET	INTAKE MANIFOLD SET	EXHAUST MANIFOLD SET	VALVE COVER SET	TIMING COVER SET	REAR SEAL SET	VALVE STEM SEAL SET
-------------	---------------------	----------------------	-----------------	------------------	---------------	---------------------

Dodge Truck, Mini-vans, & SUVs: V8

<p>OP 405-4 1992-2003 1 pc. Silicone 34408</p>	<p>MS 405-10 1992-1997 Upper & Lower 95392 ----- MS 405-11 1998-2003 Upper & Lower 95392-1 ----- MS 405-14 1992-2003 Upper 95462</p>	<p>EMS 405-6 1992-2003 95480</p>	<p>VS 405-6 1992-2003 50419</p>	<p>TCS 405-5 1992-1996 45952 ----- TCS 405-6 1997-2003 45996</p>	<p>RS 405-9 1992-2003 40181</p>	<p>SS 405-10 1992-2003 Int & Exh. 72844</p>
<p>OP 416-4 2003-2007 30750</p>	<p>MS 416-2 2003-2007 96574</p>	<p>EMS 416-2 2003-2006 96532 ----- EMS 416-4 2007 96905</p>	<p>VS 416-2 2003-2007 w/Spark Plug Seals 50625</p>	<p>TCS 416-2 2003-2007 46049</p>	<p>RS 416-2 2003-2007 Radial 40684</p>	<p>SS 416-2 2003-2007 72914</p>
<p>OP 405-3 1972-1990 6566-3 ----- OP 405-5 1991-2003 1 pc Silicone 34409</p>	<p>MS 405-4 1972-1983 2 Bbl. Carb 7/8 X 2 PORTS 95041-1 ----- MS 405-6 1972-1988 2 & 4 Bbl. Carb 1 X 2 3/16 PORTS 90109 ----- MS 405-9 1989-1992 94377 ----- MS 405-10 1993-1997 Upper & Lower 95392 ----- MS 405-11 1998-2003 Upper & Lower 95392-1 ----- MS 405-14 1993-2003 Upper 95462</p>	<p>EMS 405-5 1972-1992 90460 ----- EMS 405-6 1993-2003 95480</p>	<p>VS 405-3 1972-1992 50184 ----- VS 405-8 1972-1992 HD & HP ----- VS 405-6 1993-2003 50419</p>	<p>TCS 405-3 1971-1991 6563-1 ----- TCS 405-5 1992-1996 45952 ----- TCS 405-6 1997-2003 45996</p>	<p>RS 405-6 1971-1989 40094 ----- RS 405-10 1990-2003 40651</p>	<p>SS 405-5 1971-1975 13955X2 ----- SS 405-6 1971-1989 70014 ----- SS 405-7 1971-1989 70537 ----- SS 405-8 1971-1989 12764 ----- SS 405-9 1990-1992 72730X2 ----- SS 405-10 1993-2003 72844</p>



ENGINE INFORMATION	HEAD GASKET	HEAD KIT With <u>NO</u> Valve Stem Seals	HEAD SET With Valve Stem Seals	KIT SET	SHORT BLOCK SET
--------------------	-------------	--	--------------------------------------	---------	-----------------

Dodge Truck, Mini-vans, & SUVs: V8

6.3L 383 OHV V8 Chrysler Engine, 16 Vlv 1963-71 VIN J 1966-1971 VIN 8 1968-1970	HG 406-3 1963-1971 8519-1 ----- HG 406-5 1963-1971 Steel Shim	HK 406-3 1963-1971 Valley Pan N/I 4 Bolt VC N/I 8519-11	HS 406-3 1963-1971 Valley Pan N/I 4 Bolt VC N/I 8519-11	KS 406-3 1963-1971 Valley Pan N/I 4 Bolt VC N/I 8519	ER 406-3 1963-1971 Valley Pan N/I 4 Bolt VC N/I 8519
6.6L 400 OHV V8 Chrysler Engine, 16 Vlv 1972-80 VIN J 1971-1980	HG 406-3 1972-1980 8519-1	HK 406-3 1972-1980 Valley Pan N/I 8519-11	HS 406-3 1972-1980 Valley Pan N/I 8519-11	KS 406-3 1972-1980 Valley Pan N/I 8519-11	ER 406-3 1972-1980 Valley Pan N/I 8519-11
7.2L 440 OHV V8 Chrysler Engine, 16 Vlv 1972-80	HG 406-3 1972-1980 8519-1 ----- HG 406-5 1972-1980 Steel Shim	HK 406-3 1972-1973 Valley Pan N/I 8519-11 ----- HK 406-5 1975-80 Valley Pan N/I 8519-13	HS 406-3 1972-1973 Valley Pan N/I 8519-11 ----- HS 406-5 1975-80 Valley Pan N/I 8519-13	KS 406-3 1972-1973 Valley Pan N/I 8519-11 ----- KS 406-5 1975-80 Valley Pan N/I 8519-13	ER 406-3 1972-1973 Valley Pan N/I 8519-11 ----- ER 406-5 1975-80 Valley Pan N/I 8519-13

Dodge Truck, Mini-vans, & SUVs: V10

8.0L 488 OHV V10 Chrysler Engine, 20 Vlv 1994-2004 VIN W 1994-2004	HG 488-5 1994-2004 9034	HK 488-5 1994-2004 9034	HS 488-5 1994-2004 9034	KS 488-5 1994-2004 9034	ER 488-5 1994-2004 9034
8.3L 505 OHV V10 Chrysler Engine, 20 Vlv 2004-2006 VIN H 2004-2006	HG 488-8 2004-2006 26283	N/A	N/A	N/A	N/A

OIL PAN SET	INTAKE MANIFOLD SET	EXHAUST MANIFOLD SET	VALVE COVER SET	TIMING COVER SET	REAR SEAL SET	VALVE STEM SEAL SET
-------------	---------------------	----------------------	-----------------	------------------	---------------	---------------------

Dodge Truck, Mini-vans, & SUVs: V8

OP 406-3 1963-1971 11729-1 ----- OP-406-5 1963-1971 1 pc Silicone	VP 406-5 1963-1971 96007	EMS 406-3 1963-1971 90029	VS 406-3 1963-1971 13379	TCS 406-5 1963-1971 12460-2	RS 404-5 1963-1971 2 Pc. Rubber 40240	SS 406-5 1963-1971 12419X2
OP 406-3 1972-1980 11729-1 ----- OP-406-5 1972-1980 1 pc Silicone	VP 406-5 1972-1980 96007	EMS 406-3 1972-1980 90029	VS 406-3 1972-1980 13379	TCS 406-5 1972-1980 12460-2	RS404-5 1972-1980 2 Pc. Rubber 40240	SS 406-5 1972-1980 12419X2
OP 406-3 1972-1980 11729-1 ----- OP-406-5 1970-1980 1 pc Silicone	VP 406-5 1972-1980 96007	EMS 406-3 1972-1973 w/o Heat Shield 90029 ----- EMS 406-5 1972-1973 w/Heat Shield 90425	VS 406-3 1972-1980 13379 ----- VS 406-5 1972-1980 High Temp 50145	TCS 406-5 1972-1980 12460-2	RS404-5 1972-1980 2 Pc. Rubber 40240	SS 406-5 1972-1980 12419X2

Dodge Truck, Mini-vans, & SUVs: V10

OP 488-5 1994-2004 30695	MS 488-5 1994-2004 92542	EMS 488-5 1994-2004 92544	VS 488-5 1994-2004 50508	TCS 488-5 1994-2004 45995	RS 488-5 1994-2004 40658	SS 488-5 1994-2004 72808
N/A	MS 488-8 2004-2006 Lower Set 96638	EMS 488-5 2004-2006 96632	N/A	TCS 488-8 2004-2006 46057	RS 488-8 2004-2006 40688	SS 488-8 2004-2006 72860



ENGINE INFORMATION	HEAD GASKET	HEAD KIT With <u>NO</u> Valve Stem Seals	HEAD SET With Valve Stem Seals	KIT SET	SHORT BLOCK SET
--------------------	-------------	--	--------------------------------------	---------	-----------------

Ford, Lincoln, Mercury Cars: 4 Cyl

<p>1.3L 80.8 1324cc SOHC L4 Mazda B3 Engine, 8 Vlv 1988-97</p> <p>VIN K 1988-1989 VIN H 1990-1997</p>	<p>HG 523-8 1988-1997 9555</p>	<p>HK 523-8 1988-1993 9555B ----- HK 523-9 1994-1997 9555B-1</p>	<p>HS 523-8 1988-1993 9555B ----- HS 523-9 1994-1997 9555B-1</p>	<p>KS 523-8 1988-1993 9555B ----- KS 523-9 1994-1997 9555B-1</p>	<p>ER 523-8 1988-1993 9555B ----- ER 523-9 1994-1997 9555B-1</p>
<p>1.6L 97.5 1597cc SOHC L4 Mazda B6 Engine, 8 Vlv 1987-89</p> <p>VIN 5 1988-1989 VIN 7 1987</p>	<p>HG 522-7 1987-1989 9461</p>	<p>HK 522-7 1987-1989 9461-B1</p>	<p>HS 522-7 1987-1989 9461-B1</p>	<p>KS 522-7 1987-1989 9461-B1</p>	<p>ER 522-7 1987-1989 9461-B1</p>
<p>1.6L 97.5 1597cc DOHC L4 Mazda B6-ZE Engine, 16 Vlv 1991-94</p> <p>VIN Z 1991-1994</p>	<p>HG 971-5 1991-1994 9691</p>	<p>HK 971-5 1991-1994 9691B-1</p>	<p>HS 971-5 1991-1994 9691B-1</p>	<p>KS 971-5 1991-1994 9691</p>	<p>ER 971-5 1991-1994 9691</p>



OIL PAN SET	INTAKE MANIFOLD SET	EXHAUST MANIFOLD SET	VALVE COVER SET	TIMING COVER SET	REAR SEAL SET	VALVE STEM SEAL SET
-------------	---------------------	----------------------	-----------------	------------------	---------------	---------------------

Ford, Lincoln, Mercury Cars: 4 Cyl

<p>OP 522-7 1988-1993 30548 ----- OP 523-5 1994-1997 RTV & End Seals 30633</p>	<p>MS 523-8 1988-1990 w/2 Bbl. 94028 ----- MS 523-9 1988-1993 w/MFI Upper & Lower 94028-1 ----- MS 523-10 1994-1997 w/MFI Upper & Lowe`` 94028-2</p>	<p>EMS 523-8 1988-1993 w/o Heat Shield 94027 ----- EMS 523-9 1994-1997 w/Heat Shield 95627</p>	<p>VS 522-7 1988-1993 w/Grommets 50309 ----- VS 523-5 1994-1997 50439</p>	<p>TCS 522-6 Cam Frt. Seal Set 1988-1997 45724 ----- TCS 522-7 Crk Frt. Seal Set 1988-1992 To 1/30/92 Use w/Oil Pan 45722 ----- TCS 523-5 Crk Frt. Seal Set 1992-1997 From 2/1/92 Use w/Oil Pan 45921</p>	<p>RS 522-7 1988-1997 40634</p>	<p>SS 523-5 1988-1997 72680</p>
<p>OP 522-7 1987-1989 30548</p>	<p>MS 522-5 1987-1989 93417</p>	<p>EMS 522-5 1987-1989 93416 ----- EMS 522-6 1987-1989 Heat Shield 94029</p>	<p>VS 522-7 1987-1989 w/Grommets 50309</p>	<p>TCS 522-6 Cam Frt. Seal Set 1987-1989 45724 ----- TCS 522-7 Crk Frt. Seal Set 1987-1989 Use w/Oil Pan 45722</p>	<p>RS 522-7 1987-1989 40634</p>	<p>SS 523-5 1987-1989 72680</p>
<p>OP 522-7 1991-1994 30548</p>	<p>MS 971-5 1991-1994 95437</p>	<p>EMS 971-5 1991-1994 94532</p>	<p>VS 971-5 1991-1994 50361</p>	<p>TCS 971-6 Cam Frt. Seal Set 1991-1994 45680 ----- TCS 522-7 Crk Frt. Seal Set 1991 To 1/30/90 Use w/Oil Pan 45722 ----- TCS 523-5 Crk Frt. Seal Set 1991-1994 From 12/31/90 Use w/Oil Pan 45921</p>	<p>RS 522-7 1991-1994 40634</p>	<p>SS 913-5 1991-1994 72782</p>



ENGINE INFORMATION	HEAD GASKET	HEAD KIT With <u>NO</u> Valve Stem Seals	HEAD SET With Valve Stem Seals	KIT SET	SHORT BLOCK SET
--------------------	-------------	--	--------------------------------------	---------	-----------------

Ford, Lincoln, Mercury Cars: 4 Cyl

1.6L 97.5 1597cc DOHC Turbo L4 Mazda B6-T Engine, 16 Vlv 1991-94 VIN 6 1991, 1994	HG 971-5 1991-1994 9691	HK 971-6 1991-1994 9691-2	HS 971-6 1991-1994 9691-2	KS 971-6 1991-1994 9691-2	ER 971-6 1991-1994 9691-2
1.6L 98 1598cc OHV L4 Fiesta 3036E 1978-80 3036E ENGINE	HG 527-5 1978-80 8360-1	HK 527-5 1978-80 8360-4	HS 527-5 1978-80 8360-4	KS 527-5 1978-80 8360-2	ER 527-5 1978-80 8360-2
1.6L 98 1599cc OHV L4 Pinto / Capri 1971-73 VIN W 1971-73	HG 527-5 1971-73 8360-1	HK 527-5 1971-73 8360-4	HS 527-5 1971-73 8360-4	KS 527-6 1971-73 8360	ER 527-6 1971-73 8360
1.6L 98 SOHC L4 Ford Engine 1981-85 VIN 2 1981-1985 VIN 4 1982-1985 (H.O.) VIN 5 1983-1985 (H.O.) VIN 7 1983 Methanol HEAD BOLTS RECOMMENDED	HG 501-2 1981-1985 9309-2 Head Bolts HB 516-5 1981-1985 72672	HK 501-2 1981-1985 9118	HS 501-2 1981-1985 9118	KS 501-2 1981-1985 Oil Pan Gskt. for 85 Aluminum N/I 9118	ER 501-2 1981-1985 Oil Pan Gskt. for 1985 Aluminum Pan N/I 9118



OIL PAN SET	INTAKE MANIFOLD SET	EXHAUST MANIFOLD SET	VALVE COVER SET	TIMING COVER SET	REAR SEAL SET	VALVE STEM SEAL SET
-------------	---------------------	----------------------	-----------------	------------------	---------------	---------------------

Ford, Lincoln, Mercury Cars: 4 Cyl

<p>OP 523-5 1991-1994 RTV & End Seals 30633</p>	<p>MS 971-5 1991-1994 95437</p>	<p>EMS 971-5 1991-1994 94532</p>	<p>VS 971-5 1991-1994 50361</p>	<p>TCS 971-6 Cam Frt. Seal Set 1991-1994 45680 ----- TCS 522-7 Crk Frt. Seal Set 1991 To 1/30/90 Use w/Oil Pan 45722 ----- TCS 523-5 Crk Frt. Seal Set 1991-1994 From 12/31/90 Use w/Oil Pan 45921</p>	<p>RS 522-7 1991-1994 40634</p>	<p>SS 913-5 1991-1994 72782</p>
<p>OP 527-5 1978-1980 30392</p>	<p>MS 527-5 1978-1980 90180</p>	<p>EMS 527-5 1978-1980 90181</p>	<p>VS 527-5 1978-1980 50091-1</p>	<p>TCS 527-5 1978-1989 45159</p>	<p>RS 527-5 1978-1980 16071</p>	<p>SS 527-5 1978-1980 72514-1</p>
<p>OP 527-4 1971-1973 30254</p>	<p>MS 527-5 1971-1973 90180</p>	<p>EMS 527-5 1971-1973 90181</p>	<p>VS 527-5 1971-1973 50091-1</p>	<p>TCS 527-6 1971-1973 45075</p>	<p>RS 527-5 1971-1973 16071</p>	<p>SS 527-5 1971-1973 72514-1</p>
<p>OP 501-2 1981-1985 w/Steel Pan 30412 ----- OP 501-4 1985 Aluminum Pan 1 Pc. Silicone 30536</p>	<p>MS 501-2 1981-1985 Upper & Lower Set 90893 ----- MS 501-4 1981-1985 Upper Set 92593</p>	<p>EMS 501-4 1981-1985 92057</p>	<p>VS 501-5 1981-1985 50193</p>	<p>TCS 501-2 1981-1985 Cam Frt. Seal Set 45473 ----- TCS 501-4 1981-1985 Crk Frt. Seal Set 45483</p>	<p>RS 501-2 1981-1985 40158</p>	<p>SS 515-5 1981-1985 72514-2</p>



ENGINE INFORMATION	HEAD GASKET	HEAD KIT With <u>NO</u> Valve Stem Seals	HEAD SET With Valve Stem Seals	KIT SET	SHORT BLOCK SET
--------------------	-------------	--	--------------------------------------	---------	-----------------

Ford, Lincoln, Mercury Cars: 4 Cyl

<p>1.6L 98 SOHC Turbo L4 Ford Engine 1984-85</p> <p>VIN 8 1984-1985</p> <p>HEAD BOLTS RECOMMENDED</p>	<p>HG 501-2 1984-1985 9309-2</p> <p>Head Bolts HB 516-5 1984-1985 72672</p>	<p>HK 501-2 1984-1985 9118</p>	<p>HS 501-2 1984-1985 9118</p>	<p>KS 501-2 1984-1985 Oil Pan Gskt. for 85 Aluminum Pan Not Included 9118</p>	<p>ER 501-2 1984-1985 Oil Pan Gskt. for 1985 Aluminum Pan Not Included 9118</p>
<p>1.8L 112.2 1839cc DOHC L4 Mazda BP-ZE Engine, 16 Vlv 1991-96</p> <p>VIN 8 1991-1996</p>	<p>HG 913-5 1991-1996 9717</p>	<p>HK 913-5 1991-1996 9717</p>	<p>HS 913-5 1991-1993 9717 ----- HS 913-6 1994-1996 9717-1</p>	<p>KS 913-5 1991-1996 9717 ----- KS 913-6 1994-1996 9717-1</p>	<p>ER 913-5 1991-1996 9717</p>
<p>1.9L 116 SOHC L4 Ford Engine 1985-96</p> <p>VIN J 1985-90 (H.O.) VIN J 1991-96 VIN 9 1985-90</p> <p>ESCORT VIN J 1985-1996 ESCORT VIN 9 1985-1999 EXP VIN J, 9 1985-1988 LYNX VIN J, 99 1985-1987</p> <p>HEAD BOLTS RECOMMENDED</p>	<p>HG 501-2 1985-1996 9309-2 -----</p> <p>Head Bolts HB 516-5 1985-1996 72672</p>	<p>HK 516-7 1985-1990 w/Head Bolts Stamped Steel VC Gasket N/I 9309 ----- HK 516-9 1991-1996 w/Head Bolts Mexico Int. N/I 9309-1</p>	<p>HS 516-7 1985-1990 w/Head Bolts Stamped Steel VC Gasket N/I 9309 ----- HS 516-9 1991-1996 w/Head Bolts Mexico Int. N/I 9309-1</p>	<p>KS 516-7 1985-1990 w/Head Bolts Stamped Steel VC Gasket N/I 9309 ----- KS 516-9 1991-1996 w/Head Bolts Mexico Int. N/I 9309-1</p>	<p>ER 516-7 1985-1990 w/Head Bolts Stamped Steel VC Gasket N/I 9309 ----- ER 516-9 1991-1996 w/Head Bolts Mexico Int. N/I 9309-1</p>

OIL PAN SET	INTAKE MANIFOLD SET	EXHAUST MANIFOLD SET	VALVE COVER SET	TIMING COVER SET	REAR SEAL SET	VALVE STEM SEAL SET
-------------	---------------------	----------------------	-----------------	------------------	---------------	---------------------

Ford, Lincoln, Mercury Cars: 4 Cyl

<p>OP 501-2 1984-1985 w/Steel Pan 30412 ----- OP 501-4 1985 Aluminum Pan 1 Pc Silicone 30536</p>	<p>MS 501-2 1984-1985 Upper & Lower Set 90893 ----- MS 501-4 1984-1985 Upper Set 92593</p>	<p>EMS 501-4 1984-1985 92057</p>	<p>VS 501-5 1984-1985 50193</p>	<p>TCS 501-2 1984-1985 Cam Frt. Seal Set 45473 ----- TCS 501-4 1984-1985 Crk Frt. Seal Set 45483</p>	<p>RS 501-2 1984-1985 Radial 40158</p>	<p>SS 515-4 1981-1985 72514-2</p>
<p>OP 913-5 1991-1996 30631</p>	<p>MS 913-5 1991-1996 94612</p>	<p>EMS 913-5 1991-1996 94611</p>	<p>VS 913-5 1991-1996 50669</p>	<p>TCS 913-5 1991-1996 Cam 45860 ----- TCS 913-6 1991 Crank To 1-31-91 Use w/OP 45722 ----- TCS 913-8 1991 From 2-1-91 Crank 1993-1996 Use w/ OP 45921</p>	<p>RS 522-7 1991-1996 Radial 40634</p>	<p>SS 913-5 1991-1993 72782 ----- SS 913-6 1994-1996 72802</p>
<p>OP 501-4 1985-1993 To 2-9-93 30536 ----- OP 516-5 1993-1996 Front 2-10-93 30915</p>	<p>MS 516-2 1985-1986 &1987-1990 w/MFI Upper & Lower Set 93255 ----- MS 516-4 1987-1996 w/CFI Exc. Mexico 93935 ----- MS 516-5 1989-1990 w/MFI Upper Set 93254 ----- MS 516-18 1987-1990 w/CPI 1991-1996 Exc. Mexico Eng. Engine Saver Screened Gasket</p>	<p>EMS 501-4 1985-1996 92057</p>	<p>VS 501-5 1985 w/Steel VC 50193 ----- VS 516-5 1985-1990 Aluminum VC 50290 ----- VS 516-6 1991-1996 50369</p>	<p>TCS 501-2 1985-1996 Cam Frt. Seal Set 45473 ----- TCS 501-4 1985-1987 Crk Frt. Seal Set 45483 ----- TCS 516-5 1988-1996 Crk Frt. Seal Set Use w/ Oil Pan 45472-1</p>	<p>RS 501-2 1985-1996 Radial 40158</p>	<p>SS 515-4 1985-1991 To 5-1-91 72514-2 ----- SS 518-5 1991-1998 From 5-2-91 70654</p>



ENGINE INFORMATION	HEAD GASKET	HEAD KIT With <u>NO</u> Valve Stem Seals	HEAD SET With Valve Stem Seals	KIT SET	SHORT BLOCK SET
--------------------	-------------	--	--------------------------------------	---------	-----------------

Ford, Lincoln, Mercury Cars: 4 Cyl

2.0L 121 SOHC L4 Ford Engine 8 Vlv 1997-2004 VIN P 1997-04 ESCORT 1997-2001 FOCUS 2000-2004 TRACER USA 1997-1999 HEAD BOLTS RECOMMENDED	HG 501-2 1997-1999 9309-2 ----- HG 516-6 2000-2004 9539 Head Bolts HB 516-5 1997-2004 72672	HK 516-13 1997-1999 w/Head Bolts 9309-2 ----- HK 516-14 2000-2003 Escort 9539 ----- HK 516-15 2000-2004 Focus 9539-1	HS 516-13 1997-1999 w/Head Bolts 9309-2 ----- HS 516-14 2000-2003 Escort 9539 ----- HS 516-15 2000-2004 Focus 9539-1	KS 516-13 1997-1999 w/Head Bolts 9309 ----- KS 516-14 2000-2003 Escort 9539 ----- KS 516-15 2000-2004 Focus 9539-1	ER 516-13 1997-1999 w/Head Bolts 9309 ----- ER 516-14 2000-2003 Escort 9539 ----- ER 516-15 2000-2004 Focus 9539-1
--	---	---	---	---	---



OIL PAN SET	INTAKE MANIFOLD SET	EXHAUST MANIFOLD SET	VALVE COVER SET	TIMING COVER SET	REAR SEAL SET	VALVE STEM SEAL SET
-------------	---------------------	----------------------	-----------------	------------------	---------------	---------------------

Ford, Lincoln, Mercury Cars: 4 Cyl

<p>OP 516-5 1997-1999 From 2-10-93 30915</p>	<p>MS 516-6 1997-1999 & 2000-2003 Escort 95918 ----- MS 516-8 2000-2003 Focus 94432 ----- MS 516-10 2000-2003 Focus Engine Saver Screened Gasket</p>	<p>EMS 501-4 1985-1996 92057</p>	<p>VS 516-8 1997-2004 50476</p>	<p>TCS 501-2 1997-2004 Cam Frt. Seal Set 45473 ----- TCS 516-5 1997-2004 Use w/ Oil Pan 45472-1</p>	<p>RS 501-2 1997-2004 Radial 40158</p>	<p>SS 501-5 1997-2004 70654</p>
--	--	--	---	---	--	---



ENGINE INFORMATION	HEAD GASKET	HEAD KIT With <u>NO</u> Valve Stem Seals	HEAD SET With Valve Stem Seals	KIT SET	SHORT BLOCK SET
--------------------	-------------	--	--------------------------------------	---------	-----------------

Ford, Lincoln, Mercury Cars: 4 Cyl

<p>2.0L 121 1988cc DOHC L4 Ford Engine, 16 Vlv ZETEC 1995-2004</p> <p>VIN Z 1995-2000 (ZETEC FLEX FUEL) VIN 3 1995-04 (ZETEC) VIN 5 2002-2004 (ZETEC H.O.)</p> <p>CONTOUR VIN 3 1995-1999 CONTOUR VIN Z 1998-2000 COUGAR VIN 3 1999-2002 ESCORT VIN 3 1997-2003 ESCORT ZX2 VIN 3 1997-2003 FOCUS VIN 3 2000-2004 FOCUS VIN 5 2002-2004 MYSTIQUE VIN 3 1995-2000 MYSTIQUE VIN Z 1998-2000 TRACER VIN 3 1998-1999</p> <p>HEAD BOLTS RECOMMENDED</p>	<p>HG 538-2 1995-1999 & 2002-2003 VIN 5 Focus 9005 ----- HG 538-3 2000 & 2004 VIN 5 Focus 9005-1 ----- HG 538-4 2001-2004 VIN 3 26174</p> <p>Head Bolts HB 538-5 1995-2004 72175</p>	<p>HK 538-3 1995-1997 9005/-1 ----- HK 538-4 1998-1999 9005-2</p>	<p>HS 538-2 1995-1996 To 03/13/96 9005 ----- HS 538-3 1996-1997 From 03/14/96 9005-1 ----- HS 538-4 1998-1999 9005-2 ----- HS 538-5 2000 Focus To 12/20/99 9005-4 ----- HS 538-6 2000 Focus From 12/21/99 9005-5 ----- HS 538-7 2000 Contour, Cougar, Escort, Mystique, ZX2 9005-3 ----- HS 538-8 2002-2003 VIN 5 Focus 9005-7 ----- HS 538-9 2001-2004 VIN 3 Focus 26174 ----- HS 538-10 2001-2003 VIN 3 Cougar, Escort, ZX2 26174-1 ----- HS 538-11 2004 VIN 5 Focus 9005-8</p>	<p>KS 538-2 1995-1996 To 03/13/96 9005 ----- KS 538-3 1996-1997 From 03/14/96 9005-1 ----- KS 538-4 1998-1999 9005-2 ----- KS 538-5 2000 Focus To 12/20/99 9005-4 ----- KS 538-6 2000 Focus From 12/21/99 9005-5 ----- KS 538-7 2000 Contour, Cougar, Escort, Mystique, ZX2 9005-3 ----- KS 538-8 2002-2003 VIN 5 Focus 9005-7 ----- KS 538-9 2001-2004 VIN 3 Focus 26174 ----- KS 538-10 2001-2003 VIN 3 Cougar, Escort, ZX2 26174-1 ----- KS 538-11 2004 VIN 5 Focus 9005-8</p>	<p>ER 538-2 1995-1996 To 03/13/96 9005 ----- ER 538-3 1996-1997 From 03/14/96 9005-1 ----- ER 538-4 1998-1999 9005-2 ----- ER 538-5 2000 Focus To 12/20/99 9005-4 ----- ER 538-6 2000 Focus From 12/21/99 9005-5 ----- ER 538-7 2000 Contour, Cougar, Escort, Mystique, ZX2 9005-3 ----- ER 538-8 2002-2003 VIN 5 Focus 9005-7 ----- ER 538-9 2001-2004 VIN 3 Focus 26174 ----- ER 538-10 2001-2003 VIN 3 Cougar, Escort, ZX2 26174-1 ----- ER 538-11 2004 VIN 5 Focus 9005-8</p>
<p>2.0L 121.5 1991cc DOHC L4 Mazda FS-DE Engine, 16 Vlv 1993-97</p> <p>VIN A 1993-97</p> <p>HEAD BOLTS RECOMMENDED</p>	<p>HG 540-5 1993-1997 9711 ----- Head Bolts HB 540-5 1993-1997 74020</p>	<p>HK 540-5 1993-1997 9711</p>	<p>HS 540-5 1993-1997 9711</p>	<p>KS 540-5 1993-1997 9711</p>	<p>ER 540-5 1993-1997 9711</p>

OIL PAN SET	INTAKE MANIFOLD SET	EXHAUST MANIFOLD SET	VALVE COVER SET	TIMING COVER SET	REAR SEAL SET	VALVE STEM SEAL SET
-------------	---------------------	----------------------	-----------------	------------------	---------------	---------------------

Ford, Lincoln, Mercury Cars: 4 Cyl

<p>OP 538-2 1995-2003 Exc. 2000-2004 Focus 30686 ----- OP 538-4 2000-2004 Focus 30711</p>	<p>MS 538-2 1995-1997 95725 ----- MS 538-4 1998-2003 VIN Z & 3 Contour, Cougar, Escort, Mystique, ZX2 & 2000-2004 VIN 3 Focus 90891 ----- MS 538-5 2002-2004 VIN 5 Focus 96266</p> <p>Throttle Body</p> <p>TB 538-2 1995 w/MFI 61005 ----- TB 538-3 1996-1999 w/MFI & 2000-2003 Contour, Cougar, Escort, Mystique, ZX2 w/MFI 61105 ----- TB 538-4 2000-2004 VIN 3 Focus w/MFI 61159 ----- TB 538-5 2002-2004 VIN 5 Focus 61253</p>	<p>EMS 538-2 1995-1999 & 2000-2003 Contour, Cougar, Escort, Mystique, ZX2 95702 ----- EMS 538-4 2000-2004 Focus 94427</p>	<p>VS 538-2 1995-1997 w/Grommets 50460 ----- VS 538-4 1998-1999 & 2000-2003 VIN Z, 3 w/Grommets Contour, Cougar, Escort, Mystique, ZX2 50489 ----- VS 538-5 2000-2001 Focus From 12/21/99 & 2002-2004 VIN 3 Focus w/Grommets 50553 ----- VS 538-6 2000 Focus To 12/20/99 w/Grommets 50552 ----- VS 538-7 2002-2004 VIN 5 Focus w/Grommets 50581</p>	<p>TCS 538-2 1995-1997 & 2000-2004 VIN 3 Focus Cam Frt. Seal Set 45963 ----- TCS 538-3 1998-1999 & 2000-2003 VIN Z, 3 Contour, Cougar, Escort, Mystique, ZX2 2002-2004 VIN 5 Focus Cam Frt. Seal Set 45985 ----- TCS 538-4 1995-1997 Crankshaft Seal Must be used with Oil Pan 45964 ----- TCS 538-5 1998-1999 & 2000-2003 Contour, Cougar, Escort, Mystique, ZX2 Must be used with Oil Pan Crk Frt. Seal Set 46003 ----- TCS 538-6 2000-2004 Focus Must be used with Oil Pan Crk Frt. Seal Set 46015</p>	<p>RS 538-5 1995-2004 Radial 40618</p>	<p>SS 538-4 1995-1996 To 3/13/96 72873 ----- SS 538-5 1996-2004 From 3/14/96 72889</p>
<p>OP 540-5 1993-1997 30908</p>	<p>MS 540-5 1993-1997 96149</p>	<p>EMS 540-5 1993-1997 95425</p>	<p>VS 540-5 1993-1997 50428</p>	<p>TCS 540-5 1993-1997 Cam Seal Set 45860 ----- TCS 540-6 1993-1997 Crk Frt. Seal Set 45936</p>	<p>RS 540-5 1993-1997 40667</p>	<p>SS 540-5 1993-1997 72802</p>



ENGINE INFORMATION	HEAD GASKET	HEAD KIT With <u>NO</u> Valve Stem Seals	HEAD SET With Valve Stem Seals	KIT SET	SHORT BLOCK SET
--------------------	-------------	--	--------------------------------------	---------	-----------------

Ford, Lincoln, Mercury Cars: 4 Cyl

2.0L 121.7 1993cc SOHC L4 Ford Engine, 8 Vlv 1971-74 VIN X 1971-1974	HG 515-4 1971-1974 8361	HK 515-4 1971-1974 8361	HS 515-4 1971-1974 8361	KS 515-4 1971-1974 8361	ER 515-4 1971-1974 8361
2.0L 122 1998cc SOHC Diesel L4 Mazda RF Engine, 8 Vlv 1984-87 VIN H 1984-87	HG 514-4 1984-1987 9512	HK 514-4 1984-1987 9512	HS 514-4 1984-1987 9512	KS 514-4 1984-1987 9512	ER 514-4 1984-1987 9512
2.2L 133 2184cc SOHC L4 Mazda F2 Engine, 12 Vlv 1989-92 VIN C 1989-92	HG 976-5 1989-1992 9572	HK 976-5 1989-1992 9572-2	HS 976-5 1989-1992 9572-2	KS 976-5 1989-1992 9572-2	ER 976-5 1989-1992 9572-2
2.2L 133 2184cc SOHC Turbo L4 Mazda F2-T Engine, 12 Vlv 1989-92 VIN L 1989-92	HG 976-5 1989-1992 9572	HK 976-6 1989-1992 9572	HS 976-6 1989-1992 9572	KS 976-6 1989-1992 9572	ER 976-6 1989-1992 9572
2.3L 140 2302cc SOHC L4 Ford Engine, 8 Vlv 1974-93 VIN A 1980-90 VIN M 1991-93 VIN Y 1974-79	HG 517-5 1974-1993 8993-1	HK 517-5 1974-1984 8471-1 ----- HK 517-6 1985-1986 To 7-15-86 8993-2 ----- HK 517-7 1986-1988 From 7-16-86 8993-3 ----- HK 517-8 1989-1990 8893-5 ----- HK 517-10 1991-1993 8893-6	HS 517-5 1974-1984 8471-1 ----- HS 517-6 1985-1986 To 7-15-86 8993-2 ----- HS 517-7 1986-1988 From 7-16-86 8993-3 ----- HS 517-8 1989-1990 8893-5 ----- HS 517-10 1991-1993 8893-6	KS 517-5 1974-1984 8471-1 ----- KS 517-6 1985-1986 To 7-15-86 8993-2 ----- KS 517-7 1986-1988 From 7-16-86 8993-3 ----- KS 517-8 1989-1990 8893-5 ----- KS 517-10 1991-1993 8893-6	ER 517-5 1974-1984 8471-1 ----- ER 517-6 1985-1986 To 7-15-86 8993-2 ----- ER 517-7 1986-1988 From 7-16-86 8993-3 ----- ER 517-8 1989-1990 8893-5 ----- ER 517-10 1991-1993 8893-6

OIL PAN SET	INTAKE MANIFOLD SET	EXHAUST MANIFOLD SET	VALVE COVER SET	TIMING COVER SET	REAR SEAL SET	VALVE STEM SEAL SET
-------------	---------------------	----------------------	-----------------	------------------	---------------	---------------------

Ford, Lincoln, Mercury Cars: 4 Cyl

OP 515-4 1971-1974 30261	MS 515-4 1971-1974 90185	EMS 515-4 1971-1974 90183	VS 515-4 1971-1974 50092	TCS 515-4 1971-1974 Cam & Aux. 45448 ----- TCS 515-5 1971-1974 Crk Frt. Seal Set 45076	RS 527-5 1971-1974 16071	SS 515-4 1971-1974 72514-2
OP 514-4 1984-1986 30492 ----- OP 514-6 1987 30467	MS 514-4 1984-1987 92426	EMS 514-4 1984-1987 92427	VS 514-4 1984-1987 50255	TCS 514-4 1984-1987 Crk Frt. Seal Set 45723	RS 514-4 1984-1987 40421	SS N/A
OP 514-6 1989-1992 Lower 30467	MS 976-5 1989-1992 94199	EMS 976-5 1989-1992 94197	VS 976-5 1989-1992 50027	TCS 514-4 1989-1992 Cam & Crank 45723	RS 514-4 1989-1992 40421	SS 976-5 1989-1992 72680-1
OP 514-6 1989-1992 Lower 30467	MS 976-5 1989-1992 94199	EMS 976-5 1989-1992 94197	VS 976-5 1989-1992 50027	TCS 976-5 1989-1992 Cam Frt Seal Crk Frt Seal 2 Required 45723	RS 514-4 1989-1992 40421	SS 976-5 1989-1992 72680-1
OP 517-4 1974-1986 Multi-pc. 30297 ----- OP 517-7 1986-1990 1 Pc. Silicone 34211 ----- OP 517-9 1991-1992 1 Pc. Silicone 30545 ----- OP 517-10 1993 1 Pc. Silicone 30914	MS 517-5 1974-1990 Upper & Lower 90266-1 ----- MS 517-6 1991-1993 Upper & Lower 93391 ----- MS 517-4 1974-1984 Upper Set 92593 ----- MS 517-8 1985-1990 Upper Set 92914 ----- MS 517-7 1991-1993 Upper Set 94263	EMS 517-5 1974-1993 92424	VS 517-5 1974-1988 50126 ----- VS 517-6 1989-1993 w/Upper Int. Hi-Temp 50043-1 ----- VS 517-7 1974-1988 Hi-Temp 50043	TCS 517-5 1974-1993 Cam Frt Seal 45108 ----- TCS 517-6 1974-1993 Auxiliary Seal 45109 ----- TCS 517-4 1974-1993 Crk Frt. Seal 45107	RS 510-5 1974-1981 2 Pc. Rubber 30136 ----- RS 510-6 1981-1993 Radial 40620 ----- RS 510-8 1981-1993 Radial PTFE 40644	SS 517-5 1974-1986 70083 ----- SS 519-5 1986-1993 72683



ENGINE INFORMATION	HEAD GASKET	HEAD KIT With <u>NO</u> Valve Stem Seals	HEAD SET With Valve Stem Seals	KIT SET	SHORT BLOCK SET
--------------------	-------------	--	--------------------------------------	---------	-----------------

Ford, Lincoln, Mercury Cars: 4 Cyl

<p>2.3L 140 2302cc SOHC Turbo L4 Ford Engine, 8 Vlv 1979-89</p> <p>VIN D 1983 VIN T 1980-86 VIN W 1979 & 1983-89</p>	<p>HG 517-6 1979-1989 8993-2</p>	<p>HK 517-5 1979-1984 8471-1 ----- HK 517-6 1985-1986 To 7-15-86 8993-2 ----- HK 517-7 1986-1988 From 7-16-86 8993-3 ----- HK 517-8 1989 8993-5</p>	<p>HS 517-5 1979-1984 8471-1 ----- HS 517-6 1985-1986 To 7-15-86 8993-2 ----- HS 517-7 1986-1988 From 7-16-86 8993-3 ----- HS 517-8 1989 8993-5</p>	<p>KS 517-5 1979-1984 8471-1 ----- HS 517-6 1985-1986 To 7-15-86 8993-2 ----- HS 517-7 1986-1988 From 7-16-86 8993-3 ----- HS 517-8 1989 8993-5</p>	<p>ER 517-5 1979-1984 8471-1 ----- HS 517-6 1985-1986 To 7-15-86 8993-2 ----- HS 517-7 1986-1988 From 7-16-86 8993-3 ----- HS 517-8 1989 8993-5</p>
<p>2.3L 140 OHV L4 HSC Engine 1984-94</p> <p>VIN R 1984-85 VIN S 1985-91 (H.O.) VIN X 1985-94</p>	<p>HG 519-5 1984-1994 9814</p>	<p>HK 519-2 1984-1985 H.O. 9195-1 ----- HK 519-3 1984-1985 Exc. H.O. 9195-7 ----- HK 519-4 1985-1987 H.O. 9195-2 ----- HK 519-5 1985-1987 Exc. H.O. 9195-8 ----- HK 519-6 1988 9195-4 ----- HK 519-8 1989-1994 9814</p>	<p>HS 519-2 1984-1985 H.O. 9195-1 ----- HS 519-3 1984-1985 Exc. H.O. 9195-7 ----- HS 519-4 1985-1987 H.O. 9195-2 ----- HS 519-5 1985-1987 Exc. H.O. 9195-8 ----- HS 519-6 1988 9195-4 ----- HS 519-8 1989-1994 9814</p>	<p>KS 519-2 1984-1985 H.O. 9195-1 ----- KS 519-3 1984-1985 Exc. H.O. 9195-7 ----- KS 519-4 1985-1987 H.O. 9195-2 ----- KS 519-5 1985-1987 Exc. H.O. 9195-8 ----- KS 519-6 1988 9195-4 ----- KS 519-8 1989-1994 9814</p>	<p>ER 519-2 1984-1985 H.O. 9195-1 ----- ER 519-3 1984-1985 Exc. H.O. 9195-7 ----- ER 519-4 1985-1987 H.O. 9195-2 ----- ER 519-5 1985-1987 Exc. H.O. 9195-8 ----- ER 519-6 1988 9195-4 ----- ER 519-8 1989-1994 9814</p>
<p>2.5L 153 OHV L4 HSC Engine 1986-91</p> <p>VIN D 1986-90 OLD 520 KITS VIN N 1991</p>	<p>HG 519-5 1986-1991 9814</p>	<p>HK 519-4 1986-1988 9195-2 ----- HK 519-7 1989-1990 9195-6 ----- HK 519-9 1991 9814-1</p>	<p>HS 519-4 1986-1988 9195-2 ----- HS 519-7 1989-1990 9195-6 ----- HS 519-9 1991 9814-1</p>	<p>KS 519-4 1986-1988 9195-2 ----- KS 519-7 1989-1990 9195-6 ----- KS 519-9 1991 9814-1</p>	<p>ER 519-4 1986-1988 9195-2 ----- ER 519-7 1989-1990 9195-6 ----- ER 519-9 1991 9814-1</p>

OIL PAN SET	INTAKE MANIFOLD SET	EXHAUST MANIFOLD SET	VALVE COVER SET	TIMING COVER SET	REAR SEAL SET	VALVE STEM SEAL SET
-------------	---------------------	----------------------	-----------------	------------------	---------------	---------------------

Ford, Lincoln, Mercury Cars: 4 Cyl

<p>OP 517-4 1979-1986 Multi-pc. 30297 -----</p> <p>OP 517-7 1986-1989 Rubber 34211</p>	<p>MS 517-5 1979-1989 Upper & Lower 90266-1 -----</p> <p>MS 517-9 1979-1984 Upper Set 92592 -----</p> <p>MS 517-8 1985-1989 Upper Set 92914</p>	<p>EMS 517-5 1974-1989 92424</p>	<p>VS 517-5 1974-1988 50126 -----</p> <p>VS 517-6 1989 w/Upper Int. Hi-Temp 50043-1 -----</p> <p>VS 517-7 1974-1988 Hi-Temp 50043</p>	<p>TCS 517-5 1974-1989 Cam Frt Seal 45108 -----</p> <p>TCS 517-6 1974-1989 Auxiliary Seal 45109 -----</p> <p>TCS 517-4 1974-1989 Crk Frt. Seal 45107</p>	<p>RS 510-5 1974-1981 2 Pc. Rubber 30136 -----</p> <p>RS 510-6 1981-1989 Radial 40620 -----</p> <p>RS 510-8 1981-1989 Radial PTFE 40644 -</p>	<p>SS 517-5 1974-1986 70083 -----</p> <p>SS 519-5 1986-1989 72683</p>
<p>OP 519-5 1984-1987 34008 -----</p> <p>OP 519-6 1988 30541</p>	<p>MS 519-2 1984-1987 H.O. 92957 -----</p> <p>MS 519-4 1984-1987 Exc. H.O. 94756 -----</p> <p>MS 519-5 1988-1994 Upper & Lower 93483 -----</p> <p>MS 519-6 1988-1994 Upper Set 94032</p>	<p>EMS 519-5 1984-1994 94758</p>	<p>VS 519-5 1984-1985 Steel VC 55358 -----</p> <p>VS 519-6 1985 Aluminum VC 1986-1988 50294 -----</p> <p>VS 519-8 1989-1994 50399</p>	<p>TCS 519-5 1984-1994 45626</p>	<p>RS 519-5 1984-1994 Radial 40452 -----</p> <p>RS 519-6 1984-1994 Radial PTFE 40646</p>	<p>SS 519-2 1984-1988 70037 -----</p> <p>SS 510-9 1989-1994 72683</p>
<p>OP 519-6 1986-1988 30541</p>	<p>MS 519-2 1986-1991 92957</p>	<p>EMS 519-5 1986-1991 94758</p>	<p>VS 519-6 1986-1990 50294 -----</p> <p>VS 519-8 1991 50399</p>	<p>TCS 519-5 1986-1991 45626</p>	<p>RS 519-5 1986-1991 Radial 40452 -----</p> <p>RS 519-6 1986-1991 Radial PTFE 40646</p>	<p>SS 519-2 1986-1988 70037 -----</p> <p>SS 519-5 1989-1991 72683</p>



ENGINE INFORMATION	HEAD GASKET	HEAD KIT With <u>NO</u> Valve Stem Seals	HEAD SET With Valve Stem Seals	KIT SET	SHORT BLOCK SET
--------------------	-------------	--	--------------------------------------	---------	-----------------

Ford, Lincoln, Mercury Cars: 6 Cyl

2.4L 144 OHV L6 Ford Engine, 12 Vlv 1960-64 VIN D 1960-62 VIN S 1960-64	HG 503-3 1960-1964 7916-1	HK 503-3 1960-1964 7916-2	HS 503-3 1960-1964 7916-2	KS 503-3 1960-1964 7916-2	ER 503-3 1960-1964 7916-2
2.4L 149 2443cc SOHC Turbo Diesel L6 BMW M21D24 Engine 1984-85 VIN L 1984-1985	HG 920-1 1984-1985 1.43mm Thick 1 Notch V 4829 ----- HG 920-2 1984-1985 1.55mm Thick 2 Notch 9270 V 4830 ----- HG 920-3 1984-1985 1.70mm Thick 3 Notch 9278 V 4831	HK N/A	HSX 920-5 1984-1985 9268	KS N/A	ER N/A
2.5L 152.4 2497cc DOHC V6 Mazda KL-ZE Engine, 24 Vlv 1993-97 VIN B 1993-97	HG 541-2R 1993-1997 Right Side 9923 ----- HG 541-4L 1993-1997 Left Side 9921	HK 541-2 1993-1995 9921 ----- HK 541-4 1996-1997 9921-1	HS 541-2 1993-1995 9921 ----- HS 541-4 1996-1997 9921-1	KS 541-2 1993-1995 9921 ----- KS 541-4 1996-1997 9921-1	ER 541-2 1993-1995 9921 ----- ER 541-4 1996-1997 9921-1



OIL PAN SET	INTAKE MANIFOLD SET	EXHAUST MANIFOLD SET	VALVE COVER SET	TIMING COVER SET	REAR SEAL SET	VALVE STEM SEAL SET
-------------	---------------------	----------------------	-----------------	------------------	---------------	---------------------

Ford, Lincoln, Mercury Cars: 6 Cyl

OP 503-3 1960-1964 12701	MS 503-3 1960-1964 9789-1	USE MS	VS 503-3 1960-1964 12692	TCS 503-3 1960-1964 13059-1	RS 503-5 1960-1964 30135	SS 503-5 1960-1964 72616
OP 920-5 N/A V 30992	MS 920-4 N/A V 10058	EMS 920-5 N/A V 10052	VS N/A	TCS N/A	RS N/A	SS 920-5 N/A V 45498
OP 541-2 1993-1997 30909	MS 541-2 1993-1997 95422	EMS 541-5 1993-1997 95428	VS 541-2 1993-1995 w/Isolators & Grommets 50426 ----- VS 541-4 1996-1997 w/Grommets 50426-1	TCS 542-5 1993-1997 Cam Frt Seal Set 45966 ----- TCS 540-6 1993-1997 Crk Frt. Seal Set 45936	RS 541-5 1993-1997 40387	SS 541-5 1993-1997 72802-1



ENGINE INFORMATION	HEAD GASKET	HEAD KIT With <u>NO</u> Valve Stem Seals	HEAD SET With Valve Stem Seals	KIT SET	SHORT BLOCK SET
--------------------	-------------	--	--------------------------------------	---------	-----------------

Ford, Lincoln, Mercury Cars: 6 Cyl

<p>2.5L 155 2544cc DOHC V6 Ford Engine, 24 Vlv DURATEC 1995-2002</p> <p>VIN G 1998-02 VIN L 1995-02</p> <p>HEAD BOLTS RECOMMENDED</p>	<p>HG 542-2R 1995-2000 Right Side 9039 ----- HG 542-4L 1995-2000 Left Side 9038 ----- HG 542-6R 2001-2002 Right Side 26166 ----- HG 542-8L 2001-2002 Left Side 26165 ----- Head Bolts HB 528-5 1995-2002 72159</p>	<p>HK 542-2 1995-2000 9038 ----- HK 542-4 2001-2002 26165</p>	<p>HS 542-2 1995-2000 9038 ----- HS 542-4 2001-2002 26165</p>	<p>KS 542-2 1995-2000 9038 ----- KS 542-4 2001-2002 26165</p>	<p>ER 542-2 1995-2000 9038 ----- ER 542-4 2001-2002 26165</p>
<p>2.8L 170 OHV L6 Ford Engine, 12 Vlv 1961-72</p> <p>VIN U 1961-72</p>	<p>HG 503-3 1961-1972 7916-1</p>	<p>HK 503-3 1961-1972 7916-2</p>	<p>HS 503-3 1961-1972 7916-2</p>	<p>KS 503-3 1961-1972 7916-2</p>	<p>ER 503-3 1961-1972 7916-2</p>
<p>2.8L 171 2792cc OHV V6 12 Vlv 1974-79</p> <p>VIN Z 1974-79</p>	<p>HG 509-1R Right Side 9132 HG 509-2L Left Side 9136</p>	<p>HK 509-5 1974-1979 8451-1</p>	<p>HS 509-5 1974-1979 8451-1</p>	<p>KS 509-5 1974-1979 8451-1</p>	<p>ER 509-5 1974-1979 8451-1</p>



OIL PAN SET	INTAKE MANIFOLD SET	EXHAUST MANIFOLD SET	VALVE COVER SET	TIMING COVER SET	REAR SEAL SET	VALVE STEM SEAL SET
-------------	---------------------	----------------------	-----------------	------------------	---------------	---------------------

Ford, Lincoln, Mercury Cars: 6 Cyl

<p>OP 528-2 1995-2002 30697</p>	<p>MS 542-5 1985-2002 Upper & Lower 95726 ----- MS 542-6 1995-2002 Upper Set 95727</p>	<p>EMS 542-5 1995-2002 95715</p>	<p>VS 542-5 1995-2002 50462</p>	<p>TCS 542-5 1995-2002 Cam Frt Seal Set (2) Req'd. 45966 ----- TCS 542-6 1995-2002 Crk Frt. Seal Set 45967</p>	<p>RS 510-6 1995-2002 40620 ----- RS 510-8 1995-2002 Radial PTFE 40644</p>	<p>SS 528-5 1995-2002 72873-1</p>
<p>OP 503-3 1961-1972 12701</p>	<p>MS 503-3 1961-1972 9789-1</p>	<p>USE MS</p>	<p>VS 503-3 1961-1972 12692</p>	<p>TCS 503-3 1961-1972 13059-1</p>	<p>RS 503-5 1961-1972 30135</p>	<p>SS 503-5 1961-1972 72616</p>
<p>OP 509-3 1974-1979 30271</p>	<p>MS 509-2 1974 90280 ----- MS 509-5 1975-1979 90315</p>	<p>EMS 509-5 1974-1979 90406</p>	<p>VS 509-5 1974-1979 50115</p>	<p>TCS 509-5 1974-1979 45080</p>	<p>RS 509-8 1974-1979 40419</p>	<p>SS 509-5 1974-1979 72686-1</p>



ENGINE INFORMATION	HEAD GASKET	HEAD KIT With <u>NO</u> Valve Stem Seals	HEAD SET With Valve Stem Seals	KIT SET	SHORT BLOCK SET
--------------------	-------------	--	--------------------------------------	---------	-----------------

Ford, Lincoln, Mercury Cars: 6 Cyl

<p>2.9L 177 2935cc OHV V6 12 Vlv 1988-90</p> <p>VIN V 1988-90</p> <p>HEAD BOLTS RECOMMENDED</p>	<p>HG 524-1R 1988-1990 Right Side 9510 ----- HG 524-2L 1988-1990 Left Side 9511</p> <p>Head Bolts HB 524-5 1988-1990 1 Eng. Set 72794</p>	<p>HK 524-5 1988-1990 9510-2</p>	<p>HS524-5 1988-1990 9510-2</p>	<p>KS 524-5 1988-1990 9510-2</p>	<p>ER 524-5 1988-1990 9510-2</p>
---	---	--	---	--	--



OIL PAN SET	INTAKE MANIFOLD SET	EXHAUST MANIFOLD SET	VALVE COVER SET	TIMING COVER SET	REAR SEAL SET	VALVE STEM SEAL SET
-------------	---------------------	----------------------	-----------------	------------------	---------------	---------------------

Ford, Lincoln, Mercury Cars: 6 Cyl

OP 509-3 1988-1990 30271	MS 524-5 1988-1990 Upper & Lower 93771 ----- MS 524-6 1988-1990 Upper Set 93754	EMS 524-5 1988-1990 93849	VS 524-5 1988-1990 50312	TCS 524-5 1988-1990 45791	RS 509-8 1988-1990 40419	SS 509-5 1988-1990 72686-1
--------------------------------	---	---------------------------------	--------------------------------	---------------------------------	--------------------------------	----------------------------------



ENGINE INFORMATION	HEAD GASKET	HEAD KIT With <u>NO</u> Valve Stem Seals	HEAD SET With Valve Stem Seals	KIT SET	SHORT BLOCK SET
--------------------	-------------	--	--------------------------------------	---------	-----------------

Ford, Lincoln, Mercury Cars: 6 Cyl

<p>3.0L 181 2966cc DOHC V6 Ford Engine, 24 Vlv TAURUS, SABLE 1996-2006</p> <p>VIN S 1996-2005 (DURATEC) VIN 1 2005-2006 (DURATEC)</p> <p>TAURUS, SABLE MODELS ONLY</p>	<p>HG 528-2R Right Hand 1996-1998 9482 -----</p> <p>HG 528-3L Left Hand 1996-1998 9481 -----</p> <p>HG 528-4R Right Hand 1999-2003 9541 -----</p> <p>HG 528-5L Left Hand 1999-2003 9540 -----</p> <p>HG 528-6R Right Hand 2004-2006 26212 -----</p> <p>HG 528-7L Left Hand 2004-2006 26207 -----</p>	<p>HK 528-2 1996-1998 9481 -----</p> <p>HK 528-3 1999 9540 -----</p> <p>HK 528-4 2000 9540-1 -----</p> <p>HK 528-5 2001-2002 9540-2 -----</p> <p>HK 528-6 2003 9540-4 -----</p> <p>HK 528-8 2004-2006 26207</p>	<p>HS 528-2 1996-1998 9481 -----</p> <p>HS 528-3 1999 9540 -----</p> <p>HS 528-4 2000 9540-1 -----</p> <p>HS 528-5 2001-2002 9540-2 -----</p> <p>HS 528-6 2003 9540-4 -----</p> <p>HS 528-8 2004-2006 26207</p>	<p>KS 528-2 1996-1998 9481 -----</p> <p>KS 528-3 1999 9540 -----</p> <p>KS 528-4 2000 9540-1 -----</p> <p>KS 528-5 2001-2002 9540-2 -----</p> <p>KS 528-6 2003 9540-4 -----</p> <p>KS 528-8 2004-2006 26207</p>	<p>ER 528-2 1996-1998 9481 -----</p> <p>ER 528-3 1999 9540 -----</p> <p>ER 528-4 2000 9540-1 -----</p> <p>ER 528-5 2001-2002 9540-2 -----</p> <p>ER 528-6 2003 9540-4 -----</p> <p>ER 528-8 2004-2006 26207</p>
<p>HEAD BOLTS RECOMMENDED</p>	<p>Head Bolts HB 528-5 1996-2006 72159</p>				



OIL PAN SET	INTAKE MANIFOLD SET	EXHAUST MANIFOLD SET	VALVE COVER SET	TIMING COVER SET	REAR SEAL SET	VALVE STEM SEAL SET
-------------	---------------------	----------------------	-----------------	------------------	---------------	---------------------

Ford, Lincoln, Mercury Cars: 6 Cyl

<p>OP 528-2 Lower Set 1996-2003 30697 ----- OP 528-4 Lower Set 2004-2006 30729</p>	<p>MS 542-5 1996-1999 Upper & Lower Set 95726 ----- MS 528-4 2000-2002 Upper & Lower Set 92586 ----- MS 528-5 2003 Upper & Lower Set 96081 ----- MS 528-9 2004-2006 Upper & Lower Set 92586-1 ----- MS 542-6 1996-1999 Upper Set 95727 ----- MS 528-11 2000-2003 Upper Set 92587 ----- MS 528-12 2004-2006 Upper Set 96252</p>	<p>EMS 542-5 1996-2006 95715</p>	<p>VS 528-2 1996-1999 50509 ----- VS 528-3 2000 50510 ----- VS 528-5 2001-2003 50551 ----- VS 528-7 2004-2006 50579</p>	<p>TCS 542-6 1996-2002 Crk Frt. Seal Set Use w/Oil Pan 45967 ----- TCS 528-5 2003-2006 Crk Frt. Seal Set Use w/Oil Pan 46016 ----- TCS 542-5 2003-2006 Cam Frt Seal Set. (2) Req'd. 45966</p>	<p>RS 510-6 1996-2006 Radial 40620 ----- RS 510-8 1996-2006 Radial PTFE 40644</p>	<p>SS 528-5 1996-2006 72873-1</p>
--	--	--	---	---	---	---



ENGINE INFORMATION	HEAD GASKET	HEAD KIT With <u>NO</u> Valve Stem Seals	HEAD SET With Valve Stem Seals	KIT SET	SHORT BLOCK SET
--------------------	-------------	--	--------------------------------------	---------	-----------------

Ford, Lincoln, Mercury Cars: 6 Cyl

<p>3.0L 181 2966cc DOHC V6 Ford Engine, 24 Vlv 2000-2006</p> <p>VIN S 2000-2005 (DURATEC) VIN 1 2005-2006 (DURATEC)</p> <p>“LS” MODELS ONLY</p> <p>HEAD BOLTS RECOMMENDED</p>	<p>HG 528-8R Right Hand 2000-2002 26249 -----</p> <p>HG 528-9L Left Hand 2000-2002 26248 -----</p> <p>HG 528-10R Right Hand 2003-2006 26281 -----</p> <p>HG 528-11L Left Hand 2003-2006 26280 -----</p> <p>Head Bolts HB 528-8 2000-2006 72208</p>	<p>HK 528-10 2000-2002 26248 -----</p> <p>HK 528-11 2003-2006 26280</p>	<p>HS 528-10 2000-2002 26248 -----</p> <p>HS 528-11 2003-2006 26280</p>	<p>KS 528-10 2000-2002 26248 -----</p> <p>KS 528-11 2003-2006 26280</p>	<p>ER 528-10 2000-2002 26248 -----</p> <p>ER 528-11 2003-2006 26280</p>
<p>3.0L 181 2966cc DOHC V6 Ford Engine, 24 Vlv 2000-2006</p> <p>VIN 1 2005-2006 (DURATEC)</p> <p>FIVE HUNDRED, MONTEGO, FUSION, MILAN, ZEPHYR MODELS ONLY</p> <p>HEAD BOLTS RECOMMENDED</p>	<p>HG 528-6R Right Hand 2005-2006 26212 -----</p> <p>HG 528-7L Left Hand 2005-2006 500 / Montego Exc. Fusion, Milan,Zephyr 26207 -----</p> <p>HG 528-12L Left Hand 2006 Fusion, Milan,Zephyr 26233</p> <p>Head Bolts HB 528-5 2005-2006 72159</p>	<p>HK N/A</p>	<p>HS N/A</p>	<p>KS N/A</p>	<p>ER N/A</p>



OIL PAN SET	INTAKE MANIFOLD SET	EXHAUST MANIFOLD SET	VALVE COVER SET	TIMING COVER SET	REAR SEAL SET	VALVE STEM SEAL SET
-------------	---------------------	----------------------	-----------------	------------------	---------------	---------------------

Ford, Lincoln, Mercury Cars: 6 Cyl

<p>OP 528-2 Lower 2000-2006 30697</p>	<p>MS 528-10 2002-2006 Lower Set 96475 ----- MS 528-13 2000-2001 Upper Set 96483 ----- MS 528-14 2002-2006 Upper Set 96496</p>	<p>EMS 542-5 1996-2006 95715</p>	<p>VS 528-8 2000-2002 w/Grommets Spark Plug Seals 50610 ----- VS 528-9 2003-2006 w/Grommets Spark Plug Seals 50612</p>	<p>TCS 528-8 2000-2006 Crk Frt Seal Set 46054</p>	<p>RS 510-6 2000-2006 Radial 40620 ----- RS 510-8 2000-2006 Radial PTFE 40644</p>	<p>SS 528-7 2000-2006 72911</p>
<p>OP 528-4 Lower 2005-2006 30729</p>	<p>MS 528-9 2005-2006 Upper & Lower Set 92586-1</p>	<p>EMS 542-5 2005-2006 95715</p>	<p>VS 528-10 2005-2006 50629</p>	<p>TCS 528-5 2005-2006 Crk Frt. Seal Set Use w/Oil Pan 46016 ----- TCS 528-9 2005-2006 Cam Frt Seal Set 46071</p>	<p>RS 510-6 2005-2006 Radial 40620 ----- RS 510-8 2005-2006 Radial PTFE 40644</p>	<p>SS 528-5 2005-2006 72873-1</p>



ENGINE INFORMATION	HEAD GASKET	HEAD KIT With <u>NO</u> Valve Stem Seals	HEAD SET With Valve Stem Seals	KIT SET	SHORT BLOCK SET
--------------------	-------------	--	--------------------------------------	---------	-----------------

Ford, Lincoln, Mercury Cars: 6 Cyl

<p>3.0L 183 2982cc OHV V6 Vulcan, 12 Vlv 1986-2007</p> <p>VIN U 1986-07 VIN 1 1993-98 (FLEX FUEL) VIN 2 1996-07 (FLEX FUEL)</p> <p>HEAD BOLTS RECOMMENDED</p>	<p>HG 521-1 1986-2007 9885</p> <p>Head Bolts HB 521-5 1986-1998 To 7-13-98 72136 ----- HB 521-6 1998-2007 From 7-14-98 72174</p>	<p>HK 521-1 1986-1990 9277 ----- HK 521-2 1991-1995 9885 ----- HK 521-6 1996-2000 9885-3/4 ----- HK 521-8 2001-2007 9885-5</p>	<p>HS 521-1 1986-1990 9277 ----- HS 521-2 1991-1995 9885 ----- HS 521-6 1996-1999 To 7-26-99 9885-3 ----- HS 521-7 1999-2000 From 7-27-99 9885-4 ----- HS 521-8 2001-2007 9885-5</p>	<p>KS 521-1 1986-1990 9277 ----- KS 521-2 1991-1995 9885 ----- KS 521-6 1996-1999 To 7-26-99 9885-3 ----- KS 521-7 1999-2000 From 7-27-99 9885-4 ----- KS 521-8 2001-2007 9885-5</p>	<p>ER 521-1 1986-1990 9277 ----- ER 521-2 1991-1995 9885 ----- ER 521-6 1996-2000 9885-3/4 ----- ER 521-8 2001-2007 9885-5</p>
<p>3.0L 183 2982cc DOHC V6 Yamaha Engine, 24 Vlv 1989-95</p> <p>VIN Y 1989-05 (SHO)</p>	<p>HG 935-5 1989-1995 9821</p>	<p>HK 935-5 1989-1995 9821</p>	<p>HS 935-5 1989-1995 9821</p>	<p>KS 935-5 1989-1995 9821</p>	<p>ER 935-5 1989-1995 9821</p>
<p>3.2L 195 3152cc DOHC V6 Yamaha Engine, 24 Vlv 1993-95</p> <p>VIN P 1993-1995 (SHO)</p>	<p>HG 935-8 1993-1995 26228</p>	<p>HK 935-8 1993-1995 26228</p>	<p>HS 935-8 1993-1995 26228</p>	<p>KS 935-8 1993-1995 26228</p>	<p>ER 935-8 1993-1995 26228</p>
<p>3.3L 200 OHV L6 Ford Engine, 12 Vlv 1963-83</p> <p>VIN B 1980-82 VIN T 1963-79 VIN X 1983</p>	<p>HG 503-3 1963-1983 7916-1</p>	<p>HK 503-3 1963-1983 7916-2</p>	<p>HS 503-3 1963-1983 7916-2</p>	<p>KS 503-3 1963-1983 7916-2</p>	<p>ER 503-3 1963-1983 7916-2</p>

OIL PAN SET	INTAKE MANIFOLD SET	EXHAUST MANIFOLD SET	VALVE COVER SET	TIMING COVER SET	REAR SEAL SET	VALVE STEM SEAL SET
-------------	---------------------	----------------------	-----------------	------------------	---------------	---------------------

Ford, Lincoln, Mercury Cars: 6 Cyl

OP 521-1 1986-1990 To 3-26-90 Exc. Probe 34505 ----- OP 521-2 1990-1992 Probe 30717 ----- OP 521-3 1990-2001 From 3-27-90 Exc. Probe 1990-1992 Probe 30620 ----- OP 521-5 2002-2007 30712	MS 521-1 1986-2000 Upper & Lower Set 95372 ----- MS 521-5 2001-2007 Upper & Lower Set 95372-1 ----- MS 521-6 1986-2000 Upper Set 93491 ----- MS 521-8 2001-2007 Upper Set 94429	EMS 521-4 1986-1995 93850 ----- EMS 521-5 1996-2007 95939	VS 521-4 1986-1995 50066 ----- VS 521-5 1996-2007 w/o Grommets 50374	TCS 521-5 1986-2007 Use w/ Oil Pan 45771	RS 501-2 1986-2007 Radial 40158 ----- RS 519-6 1986-2007 Radial PTFE 40646	SS 082-6 1986-1999 To 7-26-99 70819 ----- SS 521-7 1999-2007 From 7-27-99 70964
OP 935-5 1989-1995 RTV w/End Seals 30636	MS 935-5 1989-1995 94831	EMS 935-5 1989-1995 94802	VS 935-5 1989-1995 Use w/ MS Spark Plug Seals 50378	TCS 935-5 1989-1995 Cam Frt. Seal Set 45870 ----- TCS 935-6 1989-1995 Crk Frt. Seal Set 45871	RS 935-5 1989-1995 Radial 40623	SS 935-5 1989-1995 Intake/ Exhaust 72807/72830
OP 935-5 1993-1995 RTV w/End Seals 30636	MS 935-5 1993-1995 94831	EMS 935-5 1993-1995 94802	VS 935-5 1993-1995 Use w/ MS Spark Plug Seals 50378	TCS 935-5 1993-1995 Cam Frt. Seal Set 45870 ----- TCS 935-6 1993-1995 Crk Frt. Seal Set 45871	RS 935-5 1993-1995 Radial 40623	SS 935-5 1993-1995 Intake/ Exhaust 72807/72830
OP 503-3 1963-1983 12701	MS 503-3 1963-1983 9789-1	USE MS	VS 503-3 1963-1983 12692	TCS 503-3 1963-1983 13059-1	RS 503-5 1963-1983 30135	SS 503-3 1963-1983 72616



ENGINE INFORMATION	HEAD GASKET	HEAD KIT With <u>NO</u> Valve Stem Seals	HEAD SET With Valve Stem Seals	KIT SET	SHORT BLOCK SET
--------------------	-------------	--	--------------------------------------	---------	-----------------

Ford, Lincoln, Mercury Cars: 6 Cyl

3.8L 232 OHV V6 Ford Engine, 12 Vlv REAR WHEEL DRIVE ONLY 1982-2004	HG 518-5 1982-96 RWD 8857-1 -----	HK 518-2 Steel VC 1982-83 8857 -----	HS 518-2 Steel VC 1982-83 8857 -----	KS 518-2 Steel VC 1982-83 8857 -----	ER 518-2 Steel VC 1982-83 8857 -----
VIN C 1982-85 VIN 3 1982-87 VIN 4 1988-04	HG 518-1R* Right Hand RWD 1997-98 9263 -----	HK 518-4 Steel VC To 01-15-86 1984-86 8857-2 -----	HS 518-4 Steel VC To 01-15-86 1984-86 8857-2 -----	KS 518-4 Steel VC To 01-15-86 1984-86 8857-2 -----	ER 518-4 Steel VC To 01-15-86 1984-86 8857-2 -----
	HG 518-2L* Left Hand RWD 1997-98 9262 -----	HK 518-5 Plastic VC 1986-87 From 1-16-86 8857-3 -----	HS 518-5 Plastic VC 1986-87 From 1-16-86 8857-3 -----	KS 518-5 Plastic VC 1986-87 From 1-16-86 8857-3 -----	ER 518-5 Plastic VC 1986-87 From 1-16-86 8857-3 -----
	HG 518-3R* Right Hand RWD 1999-04 9253 -----	HK 518-7 RWD Cougar/T-Bird 1988 8857-4 -----	HS 518-7 RWD Cougar/T-Bird 1988 8857-4 -----	KS 518-7 RWD Cougar/T-Bird 1988 8857-4 -----	ER 518-7 RWD Cougar/T-Bird 1988 8857-4 -----
	HG 518-4L* Left Hand RWD 1999-04 9250 -----	HK 518-9 RWD Cougar/T-Bird 1989-93 8857-5 -----	HS 518-9 RWD Cougar/T-Bird 1989-93 8857-5 -----	KS 518-9 RWD Cougar/T-Bird 1989-93 8857-5 -----	ER 518-9 RWD Cougar/T-Bird 1989-93 8857-5 -----
		HK 518-13 RWD Exc. Mustang 1994-95 8857-6 -----	HS 518-13 RWD Exc. Mustang 1994-95 8857-6 -----	KS 518-13 RWD Exc. Mustang 1994-95 8857-6 -----	ER 518-13 RWD Exc. Mustang 1994-95 8857-6 -----
		HK 518-14 RWD Mustang 1994-95 8857-7 -----	HS 518-14 RWD Mustang 1994-95 8857-7 -----	KS 518-14 RWD Mustang 1994-95 8857-7 -----	ER 518-14 RWD Mustang 1994-95 8857-7 -----
HEAD BOLTS REQUIRED	Head Bolts				
	HB 518-5 1982-1988 72129 -----	HK 518-15 RWD 1996 8857-8 -----	HS 518-15 RWD 1996 8857-8 -----	KS 518-15 RWD 1996 8857-8 -----	ER 518-15 RWD 1996 8857-8 -----
	HB 518-6 1989-1995 72131 -----	HK 518-16 RWD 1997-98 9262 -----	HS 518-16 RWD 1997-98 9262 -----	KS 518-16 RWD 1997-98 9262 -----	ER 518-16 RWD 1997-98 9262 -----
	HB 518-7 1996 72156 -----	HK 518-17 RWD 1999-04 9250-2 -----	HS 518-17 RWD 1999-04 9250-2 -----	KS 518-17 RWD 1999-04 9250-2 -----	ER 518-17 RWD 1999-04 9250 -----
	HB 518-8 1997-2004 72160				-2



OIL PAN SET	INTAKE MANIFOLD SET	EXHAUST MANIFOLD SET	VALVE COVER SET	TIMING COVER SET	REAR SEAL SET	VALVE STEM SEAL SET
-------------	---------------------	----------------------	-----------------	------------------	---------------	---------------------

Ford, Lincoln, Mercury Cars: 6 Cyl

<p>OP 518-5 1982-1987 Cork w/Cork End Seal 34000 ----- OP 518-8 1988 34002 ----- OP 518-9 1989-2000 RTV w/Rubber End Seals 30625 ----- OP 518-10 2001-2004 RTV w/Rubber End Seals 30702</p>	<p>MS 518-2 1982-1983 91240 ----- MS 518-5 1984-1987 92430 ----- MS 518-6 1988-1995 Upper & Lower Set 94045 ----- MS 518-8 1996-1998 Upper & Lower Set 95731 ----- MS 518-13 1999-2004 Lower Set 95985 ----- MS 518-7 1988-1998 Upper Set 94046 ----- MS 518-18 1999-2004 Upper Set 95981</p>	<p>EMS 518-5 1982-1995 Exc 94-95 Mustang 91346 ----- EMS 518-8 1994-1995 Mustang & 1996-1998 95528 ----- EMS 518-7 1999-2004 95968</p>	<p>VS 518-5 1982-1987 Steel VC to 1-15-86 1986-1987 Plastic VC to 1-16-96 50212 ----- VS 518-6 1986-1987 from 1-16-86 Silicone 50072 ----- VS 518-7 1982-1988 K-Cork 50212T ----- VS 518-8 1988-1993 50070 ----- VS 518-9 1994-2004 w/o Grommets 50441 ----- VS 518-10 1988-1993 K-Cork 50070</p>	<p>TCS 518-2 1982-1987 45521 ----- TCS 518-8 1988-1993 45086 ----- TCS 518-9 1994-1995 45951 ----- TCS 518-10 2000-2004 45984</p>	<p>RS 510-5 1982-1983 to 12-31-82 2 pc Rubber 30136 ----- RS 510-6 1983-2004 Radial 40620 ----- RS 510-8 1983-2004 Radial PTFE 40644</p>	<p>SS 518-5 1982-1988 Int & Exh 72654 72561-1 ----- SS 518-8 1989-1995 72708 ----- SS 518-6 1996-1998 72875-1 ----- SS 518-9 1999-2004 70864-1</p>
---	---	--	---	---	--	--



ENGINE INFORMATION	HEAD GASKET	HEAD KIT With <u>NO</u> Valve Stem Seals	HEAD SET With Valve Stem Seals	KIT SET	SHORT BLOCK SET
--------------------	-------------	--	--------------------------------------	---------	-----------------

Ford, Lincoln, Mercury Cars: 6 Cyl

3.8L 232 OHV V6 Ford Engine, 12 Vlv FRONT WHEEL DRIVE ONLY 1988-1995 VIN 4 1988-95 HEAD BOLTS REQUIRED	HG 518-8 1988-95 FWD 9560 Head Bolts HB 518-5 1988 72129 ----- HB 518-6 1989-1995 72131	HK 518-8 FWD 1988 9560 ----- HK 518-10 FWD 1989-93 9560-1 ----- HK 518-11 FWD 1994-95 9560-2	HS 518-8 FWD 1988 9560 ----- HS 518-10 FWD 1989-93 9560-1 ----- HS 518-11 FWD 1994-95 9560-2	KS 518-8 FWD 1988 9560 ----- KS 518-10 FWD 1989-93 9560-1 ----- KS 518-11 FWD 1994-95 9560-2	ER 518-8 FWD 1988 9560 ----- ER 518-10 FWD 1989-93 9560-1 ----- ER 518-11 FWD 1994-95 9560-2
3.9L 240 OHV L6 Ford Engine, 12 Vlv 1965-72 VIN B 1965-70 VIN E 1965-72 VIN V 1965-1972	HG 511-5 1965-1972 8168	HK 511-5 1965-1972 8168-3	HS 511-5 1965-1972 8168-3	KS 511-5 1965-1972 8168-2	ER 511-5 1965-1972 8168-2
4.1L 250 OHV L6 Ford Engine, 12 Vlv 1969-80 VIN C 1980 VIN L 1969-79	HG 503-3 1969-1980 7916-1	HK 503-3 1969-1980 7916-1	HS 503-3 1969-1980 7916-1	KS 504-0 1969-1980 7916-1	ER 504-0 1969-1980 7916-1

Ford, Lincoln, Mercury Cars: V8

4.2L 255 OHV V8 Ford Engine, 16 Vlv 1980-82 VIN D 1980-1982	HG 506-8 1980-1982 8704	HK 506-8 1980-1982 Valley Pan N/I 8704-1	HS 506-8 1980-1982 Valley Pan N/I 8704-1	KS 506-8 1980-1982 Valley Pan N/I 8704-1	ER 506-8 1980-1982 Valley Pan N/I 8704-1
4.3L 260 OHV V8 Ford Engine, 16 Vlv 1962-65 VIN F 1962-1965	HG 510-5 1962-1965 8548-2	HK 510-5 1962-1965 8548-11	HS 510-5 1962-1965 8548-11	KS 510-5 1962-1965 8548-16	ER 510-5 1962-1965 8548-16

OIL PAN SET	INTAKE MANIFOLD SET	EXHAUST MANIFOLD SET	VALVE COVER SET	TIMING COVER SET	REAR SEAL SET	VALVE STEM SEAL SET
-------------	---------------------	----------------------	-----------------	------------------	---------------	---------------------

Ford, Lincoln, Mercury Cars: 6 Cyl

OP 518-8 1988 34002 ----- OP 518-9 1989-1995 RTV w/Rubber End Seals 30625	MS 518-6 1988-1995 Upper & Lower Set 94045 ----- MS 518-7 1988-1995 Upper Set 94046	EMS 518-5 1988-1995 91346	VS 518-8 1988-1993 50070 ----- VS 518-9 1994-1995 50441	TCS 518-8 1988-1993 45086 ----- TCS 518-9 1994-1995 45951	RS 510-6 1988-1995 Radial 40620 ----- RS 510-8 1988-1995 Radial PTFE 40644	SS 518-5 1988 Int & Exh 72654 72561-1 ----- SS 518-8 1989-1995 72708
OP 511-5 1965-1972 30811	MS 511-5 1965-1972 90157-1	USE MS	VS 511-2 1965-1967 13799 ----- VS 511-5 1968-1972 50033	TCS 511-5 1965-1972 45044	RS 511-5 1965-1972 Radial 40509	SS 511-5 1965-1972 13807
OP 504-0 1969-1980 30217	USE EMS	EMS 503-3 1969-1980 9789-1	VS 503-3 1969-1980 12692	TCS 504-0 1969-1980 45059	RS 510-5 1969-1980 30136	SS 503-3 1969-1980 72616

Ford, Lincoln, Mercury Cars: V8

OP 510-5 1980-1982 13260	VP 506-8 1980-4/13/81 96035 ----- MS 506-8 4/14/81 -1982 91225	EMS 506-8 1980-1982 91349	VS 510-5 1980-1982 13264 ----- VS 510-7 1980-1982 Steel/Silicone Hi Perf 13264 -----	TCS 506-3 1980-1982 45450	RS 510-5 1980-1982 2 Pc. Rubber 30136	SS 510-5 1980-1981 To 4-13-81 13364 ----- SS 508-5 From 4-14-81 -82 Int & Exh. 13364-1/72562
OP 510-5 1962-1965 13260	MS 510-5 1962-1965 90103-1	EMS 510-5 1962-1965 90000	VS 510-5 1962-1965 13264 ----- VS 510-7 1980-1982 Steel/Silicone Hi Perf 13264	TCS 510-5 1962-1965 8548-16	RS 510-5 1962-1965 2 Pc. Rubber 30136	SS 508-5 1962-1965 Int & Exh. 13364-1/72562



ENGINE INFORMATION	HEAD GASKET	HEAD KIT With <u>NO</u> Valve Stem Seals	HEAD SET With Valve Stem Seals	KIT SET	SHORT BLOCK SET
--------------------	-------------	--	--------------------------------------	---------	-----------------

Ford, Lincoln, Mercury Cars: V8

4.4L 272 OHV V8 Ford Engine, 16 Vlv 1955-57 VIN B 1957 VIN M 1955 VIN U 1955-1957	HG 507-7 1955-1957 7999	HK 507-7 1955-1957 7999-3	HS 507-7 1955-1957 7999-3	KS 507-7 1955-1957 7999-3	ER 507-7 1955-1957 7999-3
--	-------------------------------	---------------------------------	---------------------------------	---------------------------------	---------------------------------



OIL PAN SET	INTAKE MANIFOLD SET	EXHAUST MANIFOLD SET	VALVE COVER SET	TIMING COVER SET	REAR SEAL SET	VALVE STEM SEAL SET
-------------	---------------------	----------------------	-----------------	------------------	---------------	---------------------

Ford, Lincoln, Mercury Cars: V8

OP 507-7 1955-1957 10701-1	MS 507-7 1955-1957 9361-1	EMS 507-5 1955-1957 9492	VS 507-5 1955-1957 w/Grommets 10680	TCS 507-7 1955-1957 10677-3	RS 507-7 1955-1957 Rope 10743 ----- RS 507-8 1955-1957 2 Pc. Rubber 6141	SS 507-5 1955-1957 10777
----------------------------------	---------------------------------	--------------------------------	--	-----------------------------------	--	--------------------------------



ENGINE INFORMATION	HEAD GASKET	HEAD KIT With <u>NO</u> Valve Stem Seals	HEAD SET With Valve Stem Seals	KIT SET	SHORT BLOCK SET
--------------------	-------------	--	--------------------------------------	---------	-----------------

Ford, Lincoln, Mercury Cars: V8

<p>4.6L 281 SOHC V8 Ford Triton ROMEO Engine, 24 Vlv 1991-2006</p> <p>VIN H 2005-2006 (Mustang Windsor) VIN V 2006 Romeo (Flex Fuel) VIN W 1991-2006 Romeo VIN X 1996-2004 (Mustang Windsor) VIN 6 1996-2000 Windsor</p> <p>HEAD BOLTS RECOMMENDED</p>	<p>HG 525-1R 1991-2008 Right Hand 9790-2 ----- HG 525-2L 1991-2008 Left Hand 9792-2</p> <p>Head Bolts HB 525-5 1991-2008 72798</p>	<p>HK 525-1 1991-1994 VIN W 1995 Cougar & T-Bird 9790 ----- HK 525-2 1995 VIN W Exc. Cougar & T-Bird, 1996-2000 VIN W 9790-2/7 ----- HK 525-3 1996-1998 VIN X & 6 9792 ----- HK 525-4 1999-2000 VIN X & 6 9792 -1 ----- HK 525-5 2001 VIN X MUSTANG (Bullitt Intake N/I) 2001-2002 VIN W 9790-16 ----- HK 525-6 2001-2002 VIN W 2002 VIN X 2003 VIN W, X 2004 VIN X 9792-6 ----- HK 525-26 2005-2008 VIN W 9792-8</p>	<p>HS 525-1 1991-1994 VIN W 1995 Cougar & T-Bird 9790 ----- HS 525-2 1995 VIN W Exc. Cougar & T-Bird, 1996-2000 VIN W 9790-2/7 ----- HS 525-3 1996-1998 VIN X & 6 9792 ----- HS 525-4 1999-2000 VIN X & 6 9792-1 ----- HS 525-5 2001 VIN X MUSTANG (Bullitt Intake N/I) 2001-2002 VIN W 9790-16 ----- HS 525-6 2001-2002 VIN W 2002 VIN X 2003 VIN W, X 2004 VIN X 9792-6 ----- HS 525-26 2005-2008 VIN W 9792-8</p>	<p>KS 525-1 1991-1994 VIN W 1995 Cougar & T-Bird 9790 ----- KS 525-2 1995 VIN W Exc. Cougar & T-Bird, 1996-2000 VIN W 9790-2/7 ----- KS 525-3 1996-1998 VIN X & 6 9792 ----- KS 525-4 1999-2000 VIN X & 6 9792-1 ----- KS 525-5 2001 VIN X MUSTANG (Bullitt Intake N/I) 2001-2002 VIN W 9790-16 ----- KS 525-6 2001-2002 VIN W 2002 VIN X 2003 VIN W, X 2004 VIN X 9792-6 ----- KS 525-26 2005-2008 VIN W 9792-8</p>	<p>ER 525-1 1991-1994 VIN W 1995 Cougar & T-Bird 9790 ----- ER 525-2 1995 VIN W Exc. Cougar & T-Bird, 1996-2000 VIN W 9790 -2/7 ----- ER 525-3 1996-1998 VIN X & 6 9792 ----- ER 525-4 1999-2000 VIN X & 6 9792-1 ----- ER 525-5 2001 VIN X MUSTANG (Bullitt Intake N/I), 2001-2002 VIN W 9790-16 ----- ER 525-6 2001-2002 VIN W 2002 VIN X 2003 VIN W, X 2004 VIN X 9792-6 ----- ER 525-26 2005-2008 VIN W 9792-8</p>
--	--	---	--	--	--

OIL PAN SET	INTAKE MANIFOLD SET	EXHAUST MANIFOLD SET	VALVE COVER SET	TIMING COVER SET	REAR SEAL SET	VALVE STEM SEAL SET
-------------	---------------------	----------------------	-----------------	------------------	---------------	---------------------

Ford, Lincoln, Mercury Cars: V8

<p>OP 525-5 1997-2003 34307 -----</p> <p>OP 525-6 1991-2008 Improved Design 30725</p> <p>Oil Filter Adapter</p> <p>63372 1991-2008 w/o Oil Cooler 70415 -----</p> <p>63274 1991-2008 w/Oil Cooler 70801</p>	<p>MS 525-1 1991-1994 VIN W 1995 Cougar & T-Bird Upper & Lower Set 94801 -----</p> <p>MS 525-2 1995 VIN W Exc. Cougar & T-Bird Upper & Lower Set 95728 -----</p> <p>MS 525-4 1996-1998 VIN X, 6 1996-2000 VIN W Lower Set 95728-2 -----</p> <p>MS 525-5 1999-2000 VIN X, 6 Lower Set 92121 -----</p> <p>MS 525-6 2001 Mustang Exc. Bullitt VIN X, 2002-2004 VIN X, 2001-2003 VIN W Lower Set 92121-3 -----</p> <p>MS 525-7 2001 VIN X Mustang Bullitt Upper & Lower Set 92121-4 -----</p> <p>MS 525-10 1991-1995 VIN W Upper Set 94800</p>	<p>EMS 525-5 1991-2008 VIN W, X, 6 92568</p> <p>THROTTLE BODY</p> <p>TB 525-4 1991-1995 TB Mtg. 60894 -----</p> <p>TB 525-8 1996-1998 Spacer to Man. 1999-2000 VIN W 61063 -----</p> <p>TB 525-2 1996-2000 TB to Spacer 2001 VIN X Mustang 2001 VIN W 2002-2008 VIN X,W 61050 -----</p> <p>TB 525-11 1999-2000 Spacer to Man. VIN X, 6 2001 VIN X Mustang Exc. Bullitt 2002-2004 VIN X 2001-2008 VIN W 61096 -----</p> <p>TB 525-8 1999-2000 Spacer to Man. VIN W 61063 -----</p> <p>TB 525-10 2001 VIN X Mustang Bullitt 61204</p>	<p>VS 525-3 1996-2000 VIN X, 6 50481 -----</p> <p>VS 525-2 1991-2002 VIN W 2001 VIN X w/Grommets 50377 -----</p> <p>VS 525-4 2002 VIN X, 2003-2004 VIN W, X 2005-2008 VIN W w/Grommets 50564</p>	<p>TCS 525-5 1991-1995 VIN W 45869 -----</p> <p>TCS 525-1 1996-1998 VIN X, 6 1996-2008 VIN W 45869-1 -----</p> <p>TCS 525-2 1099-2004 VIN X, 6 45869-2</p>	<p>RS 510-6 1991-2005 VIN W, X, 6 40620 -----</p> <p>RS 510-8 1991-2005 Radial PTFE 40644</p>	<p>SS 525-1 1991-1994 Exc. Police 72799 -----</p> <p>SS 525-2 1991-1994 Police 1995-2008 72891</p>
---	--	---	--	--	---	--



ENGINE INFORMATION	HEAD GASKET	HEAD KIT With <u>NO</u> Valve Stem Seals	HEAD SET With Valve Stem Seals	KIT SET	SHORT BLOCK SET
--------------------	-------------	--	--------------------------------------	---------	-----------------

Ford, Lincoln, Mercury Cars: V8

<p>4.6L 281 DOHC V8 Ford Triton INTECH Engine, 32 Vlv 1993-2004</p> <p>VIN V 1993-2004 INTECH VIN R 2003-2004 INTECH</p>	<p>HG 525-1R 1991-2004 RIGHT HAND 9790-2 -----</p> <p>HG 525-2L 1991-2004 LEFT HAND 9792-2</p>	<p>HK 525-7 1993-1994 VIN V 9790-6 -----</p> <p>HK 525-8 1995-2004 VIN V Intakes & Valve Cover Not Included 9790-3 -----</p> <p>HK 525-20 2003-2004 VIN R 26188</p>	<p>HS 525-7 1993-1994 VIN V 9790-6 -----</p> <p>HS 525-8 1995-2004 VIN V Intakes & Valve Cover Not Included 9790-3 -----</p> <p>HS 525-20 2003-2004 VIN R 26188</p>	<p>KS 525-7 1993-1994 VIN V 9790-6 -----</p> <p>KS 525-8 1995-2004 VIN V Intakes & Valve Cover Not Included 9790-3 -----</p> <p>KS 525-20 2003-2004 VIN R 26188</p>	<p>ER 525-7 1993-1994 VIN V 9790-6 -----</p> <p>ER 525-8 1995-2004 VIN V Intakes & Valve Cover Not Included 9790-3 -----</p> <p>ER 525-20 2003-2004 VIN R 26188</p>
<p>HEAD BOLTS RECOMMENDED</p>	<p>Head Bolts HB 525-5 1993-2004 72798</p>				

OIL PAN SET	INTAKE MANIFOLD SET	EXHAUST MANIFOLD SET	VALVE COVER SET	TIMING COVER SET	REAR SEAL SET	VALVE STEM SEAL SET
-------------	---------------------	----------------------	-----------------	------------------	---------------	---------------------

Ford, Lincoln, Mercury Cars: V8

<p>OP 525-5 1993-2004 34307 30725</p> <p>Oil Filter Adapter 63372 1991-2006 w/o Oil Cooler 70415 ----- 63274 1991-2006 w/Oil Cooler 70801</p>	<p>MS 525-12 1993-1997 Continental 1993-1996 Mark VIII Lower Set 95714 ----- MS 525-11 1996-1998 Mustang Lower Set 95833 ----- MS 525-24 1997-1998 Mark VIII Lower Set 95736 ----- MS 525-23 1998 Continental Lower Set 95694 ----- MS 525-22 1999-2002 Continental & Mustang Lower Set 92562 ----- MS 525-26 2003-2004 VIN V Marauder Upper & Lower Set 96139-1 ----- MS 525-25 2003-2004 VIN R Mustang Upper & Lower Set 96139 ----- MS 525-13 1993-1995 Continental & Mark VIII Upper Set 95924</p>	<p>EMS 525-5 1993-2004 VIN W, X, 6 92568</p> <p>Intake Sets Continued</p> <p>MS 525-8 1996-1998 Mustang Upper Set 95925-1 ----- MS 525-9 1996-1998 Mark VIII Upper Set 95925 ----- MS 525-30 1999-2001 Mustang Upper Set 95925-2 ----- MS 525-31 1998-2002 Continental Upper Set 95841 ----- MS 525-32 2003-2004 VIN V, R Marauder Mustang Upper Set 96108</p>	<p>VS 525-6 1993-1996 & 1997-1998 Mustang w/Grommets 50479 ----- VS 525-8 1997-1998 Continental Mark VIII 1999-2004 w/Grommets & Spark Plug Seals ALL 50477</p> <p>THROTTLE BODY</p> <p>TB 525-5 1993-1996 w/MFI Mtg. 1997-2002 Continental Model 61041 ----- TB 525-6 1997-2004 w/MFI Mtg. Marauder Mark VIII Mustang 61042</p>	<p>TCS 525-6 1993-2004 45980</p>	<p>RS 510-6 1993-2004 40620 ----- RS 510-8 1993-2004 Radial PTFE 40644</p>	<p>SS 525-3 1993-1994 70857X2 ----- SS 525-4 1995-2004 72888</p>
---	--	--	--	--	--	--



ENGINE INFORMATION	HEAD GASKET	HEAD KIT With <u>NO</u> Valve Stem Seals	HEAD SET With Valve Stem Seals	KIT SET	SHORT BLOCK SET
--------------------	-------------	--	--------------------------------------	---------	-----------------

Ford, Lincoln, Mercury Cars: V8

<p>4.6L 281 SOHC V8 Ford Triton Mustang Windsor Engine, 24 Vlv 2005-2008</p> <p>VIN H 2005-2008 Mustang Windsor</p>	<p>HG 525-25L 2005-2008 26308 ----- HG 525-26R 2005-2008 26309</p>	<p>HK 525-25 20055-2008 26308</p>	<p>HS 525-25 20055-2008 26308</p>	<p>KS 525-25 20055-2008 26308</p>	<p>ER 525-25 20055-2008 26308</p>
<p>4.6L 281 SOHC NG V8 Ford Triton Engine, 24 Vlv 1996-2004</p> <p>VIN 9 1996-2005 CNG</p> <p>HEAD BOLTS RECOMMENDED</p>	<p>HG 525-1R 1996-2004 RIGHT HAND 9790-2 ----- HG 525-2L 1996-2004 LEFT HAND 9792-2</p> <p>Head Bolts HB 525-5 1996-2004 72798</p>	<p>HK 525-2 1996-2000 9790-2/7 ----- HK 525-5 2001-2002 9790-16 ----- HK 525-6 2003 9792-6 ----- HK 525-26 2004-2006 9792-8</p>	<p>HS 525-2 1996-2000 9790-2/7 ----- HS 525-5 2001-2002 9790-16 ----- HS 525-6 2003 9792-6 ----- HS 525-26 2004-2006 9792-8</p>	<p>KS 525-2 1996-2000 9790-2/7 ----- KS 525-5 2001-2002 9790-16 ----- KS 525-6 2003 9792-6 ----- KS 525-26 2004-2006 9792-8</p>	<p>ER 525-2 1996-2000 9790-2/7 ----- ER 525-5 2001-2002 9790-16 ----- ER 525-6 2003 9792-6 ----- ER 525-26 2004-2006 9792-8</p>
<p>4.6L 281 DOHC V8 Ford Triton Engine, 32 Vlv 2003-04</p> <p>VIN Y 2003-2004 INTECH SUPERCHARGED</p> <p>HEAD BOLTS RECOMMENDED</p>	<p>HG 525-3R 2003-2004 Right Hand 26222 ----- HG 525-4L 2003-2004 Left Hand 26187</p> <p>Head Bolts HB 525-6 2003-2004 71173</p>	<p>HK 525-20 2003-2004 26187</p>	<p>HS 525-20 2003-2004 26187</p>	<p>KS 525-20 2003-2004 26187</p>	<p>ER 525-20 2003-2004 26187</p>
<p>4.7L 289 OHV V8 Ford Engine, 16 Vlv 1963-68</p>	<p>HG 510-5 1963-1968 8548-2</p>	<p>HK 510-5 1963-1968 8548-2</p>	<p>HS 510-5 1963-1968 8548-2</p>	<p>KS 510-5 1963-1968 8548-2</p>	<p>ER 510-5 1963-1968 8548-2</p>

OIL PAN SET	INTAKE MANIFOLD SET	EXHAUST MANIFOLD SET	VALVE COVER SET	TIMING COVER SET	REAR SEAL SET	VALVE STEM SEAL SET
-------------	---------------------	----------------------	-----------------	------------------	---------------	---------------------

Ford, Lincoln, Mercury Cars: V8

OP 525-6 2005-2008 30725	MS 525-34 2005-2008 96687-1 THROTTLE BODY TB 525-9 w/MFI Mtg. 61426	EMS 525-8 2005-2008 96679	VS 525-10 2005-2008 w/Grommets 50664	TCS 525-14 2005-2008 46072	RS 510-6 2005-2008 40620 ----- RS 510-8 2005-2008 Radial PTFE 40644	SS 525-8 2005-2008 72921-1
OP 525-5 1996-2003 34307 30725 Oil Filter Adapter 63372 1991-2006 w/o Oil Cooler 70415 ----- 63274 1991-2006 w/Oil Cooler 70801	MS 525-4 1996-2000 Lower Set 95728-2 ----- MS 525-6 2001-2003 Lower Set 92121-3	EMS 525-5 1996-2005 92568	VS 525-2 1996-2002 W/Grommets 50377 ----- VS 525-4 2003-2005 W/Grommets 50564	TCS 525-1 1996-2005 45869-1	RS 510-6 1996-2005 40620 ----- RS 510-8 1996-2005 Radial PTFE 40644	SS 525-2 1996-2005 72891
OP 525-5 2003-2004 34307 30725 Oil Filter Adapter 63372 1991-2006 w/o Oil Cooler 70415 ----- 63274 1997-2003 w/Oil Cooler 70801	MS 525-28 2003-2004 Lower Set 96114 ----- MS 525-27 2003-2004 Upper Set 96110	EMS 525-5 2003-2004 92568	VS 525-8 2003-2004 W/Grommets 50477	TCS 525-7 2003-2004 45980-1	RS 510-6 2003-2004 40620 ----- RS 510-8 2003-2004 Radial PTFE 40644	SS 525-4 2003-2004 72888
OP 510-5 1963-1968 13260	MS 510-5 1963-1968 90103-1 ----- MS 510-3 1963-1968 Hi-Performance 90116-1	EMS 510-5 1963-1968 90000	VS 510-5 1963-1968 13264 ----- VS 510-7 1963-1985 Steel/Silicone Hi Perf 13264	TCS 510-5 1963-1968 45008	RS 510-5 1963-1968 2 Pc. Rubber 30136	SS 508-5 1963-1968 Int & Exh. 13364-1/72562



ENGINE INFORMATION	HEAD GASKET	HEAD KIT With <u>NO</u> Valve Stem Seals	HEAD SET With Valve Stem Seals	KIT SET	SHORT BLOCK SET
--------------------	-------------	--	--------------------------------------	---------	-----------------

Ford, Lincoln, Mercury Cars: V8

4.8L 292 OHV V8 Ford Engine, 16 Vlv 1955-62	HG 507-7 1955-1962 7999	HK 507-7 1955-1962 7999-3	HS 507-7 1955-1962 7999-3	KS 507-7 1955-1962 7999-3	ER 507-7 1955-1962 7999-3
5.0L 302 OHV V8 Ford Engine, 16 Vlv 1968-95 VIN D 1969-1975 VIN D 1993-1995 (COBRA) VIN E 1985-1993 VIN F 1968-1991 VIN G 1969-1971 (BOSS & ELIMINA-TOR) VIN J 1968 VIN M 1983-1987 VIN T 1991-1995	HG 510-5 1968-1995 Exc H.P. & H.O. 8548-2 ----- HG 510-8 1968-1971 Vin D, F, J H.P. Eng. 1982-1984 H.O. Eng. 1985 H.O. w/MFI 1972-1995 H.P. Eng. 9333-1 ----- HG 510-9 1969-1971 Vin G Boss & Eliminator 8346	HK 510-5 1968-1985 Exc H.P. & H.O. 8548-11 ----- HK 510-6 1982-1984 H.O. Eng. 1985 H.O. w/MFI 9333 ----- HK 510-8 1985 H.O. w/ 4 Bbl 1986-1990 9280-2 ----- HK 510-10 1991-1992 1993-1995 Vin E & T 1993-1995 Vin D MS N/I 9280-3	HS 510-5 1968-1985 Exc H.P. & H.O. 8548-11 ----- HS 510-6 1982-1984 H.O. Eng. 1985 H.O. w/MFI 9333 ----- HS 510-8 1985 H.O. w/ 4 Bbl 1986-1990 9280-2 ----- HS 510-10 1991-1992 1993-1995 Vin E & T 1993-1995 Vin D MS N/I 9280-3	KS 510-5 1968-1985 Exc H.P. & H.O. 8548-11 ----- KS 510-6 1982-1984 H.O. Eng. 1985 H.O. w/MFI 9333 ----- KS 510-8 1985 H.O. w/ 4 Bbl 1986-1990 9280-2 ----- KS 510-10 1991-1992 1993-1995 Vin E & T 1993-1995 Vin D MS N/I 9280-3	ER 510-5 1968-1985 Exc H.P. & H.O. 8548-11 ----- ER 510-6 1982-1984 H.O. Eng. 1985 H.O. w/MFI 9333 ----- ER 510-8 1985 H.O. w/ 4 Bbl 1986-1990 9280-2 ----- ER 510-10 1991-1992 1993-1995 Vin E & T 1993-1995 Vin D MS N/I 9280-3



OIL PAN SET	INTAKE MANIFOLD SET	EXHAUST MANIFOLD SET	VALVE COVER SET	TIMING COVER SET	REAR SEAL SET	VALVE STEM SEAL SET
-------------	---------------------	----------------------	-----------------	------------------	---------------	---------------------

Ford, Lincoln, Mercury Cars: V8

<p>OP 507-7 1955-1962 10701-1</p>	<p>MS 507-7 1955-1962 9361-1</p>	<p>EMS 507-5 1955-1962 9492</p>	<p>VS 507-5 1955-1962 10680 ----- VS 507-7 1960-62 12949</p>	<p>TCS 507-7 1955-1962 10677-3</p>	<p>RS 507-7 1955-1962 Rope 10743 ----- RS 507-8 1957-1965 2 pc Rubber 6141</p>	<p>SS 507-5 1955-1962 10777</p>
<p>OP 510-5 1968-1994 4 Pc. Set 13260 ----- OP 510-6 1986-1995 1 Pc. Silicone 34508</p>	<p>MS 510-5 1968-1976 Exc Thermactor & H.P. H.O. 90103-1 ----- MS 510-3 1968-1970 H.P. 90116-1 ----- MS 506-5 1977-1985 90361 ----- MS 510-8 1986-1992 1993-1995 Vin E, T Upper & Lower Set 93334 ----- MS 510-9 1993-1995 Vin D Upper & Lower Set 95952 ----- MS 510-7 1986-1992 1993-1995 Vin E, T Upper Set 94555 ----- MS 510-10 1993-1995 Vin D Upper Set 95953</p>	<p>EMS 510-5 1968-1995 90000</p>	<p>VS 510-5 1968-1987 13264 ----- VS 510-7 From 5-30-87 To 1998 Steel Rail/Silicone 13264 ----- VS 510-8 1987-1995 High Temp Cork w/Compression Stops 50029</p>	<p>TCS 510-5 1968-1978 45008 ----- TCS 506-3 1979-1995 Use w/OP From 1986-1995 45449</p>	<p>RS 510-5 1968-11/30-82 2 Piece 30136 ----- RS 510-6 From 12-1-82 To 5-31-87 Radial 40620 ----- RS 510-8 From 12-1-82 To 1995 Radial PTFE 40644</p>	<p>SS 510-4 1968-1985 Intake 13364-1 ----- SS 510-7 1968-1988 1989-1990 Exc. Mustang From 2-1-88 Mark VIII Towncar To 4-11-89 Exhaust 72562 ----- SS 510-8 1986-1990 Intake 70070 ----- SS 517-6 1988-1990 Mustang & Mark VIII From 2-1-1988 1988-1990 Towncar From 4-12-89 Exhaust 70373 ----- SS 519-5 1991-1995 72683</p>



ENGINE INFORMATION	HEAD GASKET	HEAD KIT With <u>NO</u> Valve Stem Seals	HEAD SET With Valve Stem Seals	KIT SET	SHORT BLOCK SET
--------------------	-------------	--	--------------------------------------	---------	-----------------

Ford, Lincoln, Mercury Cars: V8

5.1L 312 OHV V8 Ford Engine, 16 Vlv 1956-60 VIN D 1957 VIN E 1956-1957 VIN F 1957 VIN L 1958 VIN P 1956-1960	HG 507-7 1956-1960 7999	HK 507-7 1956-1960 7999-3	HS 507-7 1956-1960 7999-3	KS 507-7 1956-1960 7999-3	ER 507-7 1956-1960 7999-3
5.8L 351 OHV V8 Ford Cleveland Engine, 16 Vlv 1970-74 VIN H 1970-1974 VIN M 1970-1971 VIN Q 1971-1974 (Cobra Jet) VIN R 1971-1972 (Boss)	HG 508-5 1970-1974 8347-1	HK 508-3 1970-1974 Valley Pan N/I 8347	HS 508-3 1970-1974 Valley Pan N/I 8347	KS 508-3 1970-1974 Valley Pan N/I 8347	ER 508-3 1970-1974 Valley Pan N/I 8347
5.8L 351 OHV V8 Ford Modified Engine, 16 Vlv 1975-79 VIN H 1970-1974 VIN M 1970-1971 VIN Q 1971-1974 (Cobra Jet) VIN R 1971-1972 (Boss)	HG 508-5 1975-1979 8347-1	HK 508-3 1975-1979 Valley Pan N/I 5347	HS 508-3 1975-1979 Valley Pan N/I 8347	KS 508-3 1975-1979 Valley Pan N/I 8347	ER 508-3 1975-1979 Valley Pan N/I 8347
5.8L 351 OHV V8 Ford Windsor Engine, 16 Vlv 1969-91 VIN C 1995-1996 (Cobra) VIN G 1980-1991 VIN H 1969-1979 VIN M 1969-1971	HG 510-5 1969-1991 8548-2	HK 506-2 1969-1974 8548-2 ----- HK 506-5 1975-5/31/87 8548-6	HS 506-2 1969-1974 8548-2 ----- HK 506-5 1975-5/31/87 8548-6	KS 506-2 1969-1974 8548-2 ----- KS 506-5 1975-7/10/83 8548-15 ----- KS 506-6 7/11/83-5/30/87 8548-6/CS-3 ----- KS 506-7 6/1/87-1997 8548-9/CS-7	ER 506-2 1969-1974 8548-2 ----- ER 506-5 1975-7/10/83 8548-15 ----- ER 506-6 7/11/83-5/30/87 8548-6/CS-3 ----- ER 506-7 6/1/87-1997 8548-9/CS-7

OIL PAN SET	INTAKE MANIFOLD SET	EXHAUST MANIFOLD SET	VALVE COVER SET	TIMING COVER SET	REAR SEAL SET	VALVE STEM SEAL SET
-------------	---------------------	----------------------	-----------------	------------------	---------------	---------------------

Ford, Lincoln, Mercury Cars: V8

OP 507-7 1956-1960 10701-1	MS 507-7 1956-1960 9361-1	EMS 507-5 1956-1960 9492	VS 507-5 1956-1959 10680 ----- VS 507-7 1960 12949	TCS 507-7 1956-1960 10677-3	RS 507-7 1956-1960 Rope 10743 ----- RS 507-8 1955-1960 2 pc Rubber 6141	SS 507-5 1956-1960 10777
OP 508-3 1970-1974 30227	VP 508-2 2 Bbl Carb Exc Thermactor 96010 ----- VP 508-4 4 Bbl Carb & 2 Bbl Thermactor 96012	EMS 508-2 2 Bbl Carb 90526 ----- EMS 508-5 4 Bbl Carb 90332	VS 508-5 1970-1974 50068	TCS 508-3 1970-1974 45061	RS 508-5 1970-1974 40042	SS 508-5 1970-1974 13364-1/72562
OP 508-3 1975-1979 30227	VP 508-5 1975-1979 96020	EMS 508-2 1975-1979 90526	VS 508-5 1975-1979 50068	TCS 508-3 1975-1979 45061	RS 508-5 1975-1979 40042	SS 508-5 1975-1979 13364-1/72562
OP 506-3 1969-1991 30214 ----- OP 506-8 From 6-28-87 to 1991 1 Pc. Rubber 30616	MS 506-4 1969-1974 Exc. Thermactor 90116 ----- MS 506-5 1975-1991 90361	EMS 510-5 1969-1991 90000	VS 510-5 1969-1987 13364 ----- VS 510-8 1969-1991 High Temp w/Compression Stops 50029	TCS 510-5 1969-1978 WP To Plate N/I 45008 ----- TCS 506-3 1979-1991 WP To Plate N/I 45449	RS 508-5 1969-7/10-83 2 Piece 40042 ----- RS 511-5 From 7/11/83 To 5-31-87 Radial 40509 ----- RS 511-6 From 6-1-87 To 1991 Radial 40592	SS 510-5 1969 To 12-1-75 13364 ----- SS 510-3 From 12-2-75 To 7-21-86 13807-1 ----- SS 510-8 From 7-22-86 To 1991 70076/70373



ENGINE INFORMATION	HEAD GASKET	HEAD KIT With <u>NO</u> Valve Stem Seals	HEAD SET With Valve Stem Seals	KIT SET	SHORT BLOCK SET
--------------------	-------------	--	--------------------------------------	---------	-----------------

Ford, Lincoln, Mercury Cars: V8

5.8L 352 OHV V8 Ford Engine, 16 Vlv 1958-67 VIN H 1958-1961 VIN R 1960-1961 VIN X 1960-1967 VIN Y 1960	HG 505-3 1958-1967 8554	HK 505-3 1958-1967 8554	HS 505-3 1958-1967 8554	KS 505-3 1958-1967 8554	ER 505-3 1958-1967 8554
6.4L 390 OHV V8 Ford Engine, 16 Vlv 1961-71 VIN H 1964-1969 VIN M 1961-1967 VIN P 1963-1967 VIN Q 1961-1962 VIN R 1961-1962 VIN S 1966-1969 (GT) VIN X 1967-1970 VIN Y 1964-1971 VIN Z 1961-1968 VIN 9 1963-1965	HG 505-3 1961-1971 8554	HK 505-3 1961-1971 8554	HS 505-3 1961-1971 8554	KS 505-3 1961-1971 8554	ER 505-3 1961-1971 8554
6.6L 400 OHV V8 Ford Engine, 16 Vlv 1971-79 VIN S 1971-1979	HG 508-5 1971-1979 8347-1	HK 508-3 1971-1979 Valley Pan N/I 5347	HS 508-3 1971-1979 Valley Pan N/I 5347	KS 508-3 1971-1979 Valley Pan N/I 5347	ER 508-3 1971-1979 Valley Pan N/I 5347
6.6L 406 OHV V8 Ford Engine, 16 Vlv 1962-63 VIN B 1962-1963 VIN G 1962-1963	HG 505-3 1962-1963 8554	HK 505-3 1962-1963 8554	HS 505-3 1962-1963 8554	KS 505-3 1962-1963 8554	ER 505-3 1962-1963 8554

OIL PAN SET	INTAKE MANIFOLD SET	EXHAUST MANIFOLD SET	VALVE COVER SET	TIMING COVER SET	REAR SEAL SET	VALVE STEM SEAL SET
-------------	---------------------	----------------------	-----------------	------------------	---------------	---------------------

Ford, Lincoln, Mercury Cars: V8

OP 505-3 1958-1967 11701	MS 505-3 1958-1967 90145	EMS 505-6 1958-1967 9906	VS 505-3 1958-1967 13049	TCS 505-2 1958-1960 11700-1 ----- TCS 505-3 1961-1967 13075-1	RS 505-4 1958-1967 2 Pc. Rubber 30138	SS 505-5 1958-1967 13401
OP 505-3 1961-1971 11701	MS 505-3 1961-1971 90145	EMS 505-2 1961-1965 9906 ----- EMS 505-3 1966-1971 9812	VS 505-3 1961-1971 13049	TCS 505-3 1961-1971 13075-1	RS 505-4 1961-1971 30138	SS 505-5 1961-1971 13401
OP 508-3 1971-1979 30227	VP 508-2 1971-74 2 Bbl Carb Exc Thermactor 96013 ----- VP 508-6 1971-74 4 Bbl Carb & 2 Bbl Thermactor 96017 ----- VP 508-5 1975-1979 96020	EMS 508-2 1971-1979 90526	VS 508-5 1971-1979 50068	TCS 508-3 1971-1979 45061	RS 508-5 1971-1979 40042	SS 508-5 1971-1979 Int. & Exh. 13364-1/72562
OP 505-3 1962-1963 11701	MS 505-3 1962-1963 90145	N/R	VS 505-3 1962-1963 13049	TCS 505-3 1962-1963 13075-1	RS 505-4 1962-1963 2 Pc. Rubber 30138	SS 505-5 1962-1963 13401



ENGINE INFORMATION	HEAD GASKET	HEAD KIT With <u>NO</u> Valve Stem Seals	HEAD SET With Valve Stem Seals	KIT SET	SHORT BLOCK SET
--------------------	-------------	--	--------------------------------------	---------	-----------------

Ford, Lincoln, Mercury Cars: V8

<p>7.0L 427 OHV V8 Ford Engine, 16 Vlv 1963-68</p> <p>VIN L 1965-1967 VIN M 1965-1967 VIN Q 1963-1965 VIN R 1963-1968 VIN W 1966-1969</p>	<p>HG 505-3 1963-1968 8554</p>	<p>HK 505-3 1963-1968 8554</p>	<p>HS 505-3 1963-1968 8554</p>	<p>KS 505-3 1963-1968 8554</p>	<p>ER 505-3 1963-1968 8554</p>
<p>7.0L 428 OHV V8 Ford Engine, 16 Vlv 1966-70</p> <p>VIN P 1966-1970 (Police) VIN Q 1966-1970 VIN R 1968-1970 (Cobra & Super Cobra Jet)</p>	<p>HG 505-3 1966-1970 8554</p>	<p>HK 505-3 1966-1970 CJ & SCJ Int. N/I 8554</p>	<p>HS 505-3 1966-1970 CJ & SCJ Int. N/I 8554</p>	<p>KS 505-3 1966-1970 CJ & SCJ Int. N/I 8554</p>	<p>ER 505-3 1966-1970 CJ & SCJ Int. N/I 8554</p>
<p>7.0L 429 OHV V8 Ford Engine, 16 Vlv 1968-73</p> <p>VIN C 1970-1971 (Cobra & Super Cobra Jet) VIN J 1970-1971 (Cobra & Super Cobra Jet) VIN K 1969-1971 VIN N 1968-1973 VIN P (Police) VIN Z (Boss)</p>	<p>HG 512-5 1968-1973 8265-1</p>	<p>HK 512-5 1968-1973 Boss, C.J. SCJ Intake N/I 8265-1</p>	<p>HS 512-5 1968-1973 Boss, C.J. SCJ Intake N/I 8265-1</p>	<p>KS 512-5 1968-1973 Boss, C.J. SCJ Intake N/I 8265-1</p>	<p>ER 512-5 1968-1973 Boss, C.J. SCJ Intake N/I 8265-1</p>
<p>7.5L 460 OHV V8 Ford Engine, 16 Vlv 1968-78</p> <p>VIN A 1968-1978 VIN C 1973-1978 (Police)</p>	<p>HG 512-5 1968-1978 8265-1</p>	<p>HK 512-5 1968-1978 Valley Pan N/I 8265-1 ----- HK 512-8 w/Valley Pan 1974-1978</p>	<p>HS 512-5 1968-1978 Valley Pan N/I 8265-1 ----- HS 512-8 w/Valley Pan 1974-1978</p>	<p>KS 512-5 1968-1978 Valley Pan N/I 8265-1 ----- KS 512-8 w/Valley Pan 1974-1978</p>	<p>ER 512-5 1968-1978 Valley Pan N/I 8265-1 ----- ER 512-8 w/Valley Pan 1974-1978</p>

OIL PAN SET	INTAKE MANIFOLD SET	EXHAUST MANIFOLD SET	VALVE COVER SET	TIMING COVER SET	REAR SEAL SET	VALVE STEM SEAL SET
-------------	---------------------	----------------------	-----------------	------------------	---------------	---------------------

Ford, Lincoln, Mercury Cars: V8

OP 505-3 1963-1968 11701	MS 505-3 1963-1968 Exc. H.P. 90145	N/R	VS 505-3 1963-1968 13049	TCS 505-3 1963-1968 13075-1	RS 505-4 1963-1968 2 Pc. Rubber 30138	SS 505-5 1963-1968 13401
OP 505-3 1966-1970 11701	MS 505-5 1966-1970 Exc CJ & SCJ 90145	EMS 505-3 1966-1970 9812 ----- EMS 505-5 1966-1970 Heat Shield 95000	VS 505-3 1966-1970 13049	TCS 505-3 1966-1970 13075-1	RS 505-4 1966-1970 2 Pc. Rubber 30138	SS 505-5 1966-1970 13401
OP 512-5 1968-1973 30408	MS 512-5 1968-1973 Exc. Boss, CJ, SCJ 90110-1 ----- MS 512-8 Boss, CJ, SCJ Not In Kits 1231	EMS 512-5 1968-1973 90291 ----- EMS 512-8 1968-193 Heat Shield 90256	VS 512-5 1968-1973 50044	TCS 512-3 1968-1973 45024	RS 512-5 1968-1973 2 Pc. Rubber 40032	SS 510-5 1968-1973 13364
OP 512-5 1968-1978 30408	MS 512-5 1968-1973 90110-1 ----- VP 512-5 1974-1978 96018	EMS 512-5 1968-1978 90291 ----- EMS 512-8 1968-1978 Heat Shield 90248	VS 512-5 1968-1978 50044	TCS 512-5 1968-1978 45024	RS 512-5 1968-1978 40032	SS 510-5 1968-1978 13364



ENGINE INFORMATION	HEAD GASKET	HEAD KIT With <u>NO</u> Valve Stem Seals	HEAD SET With Valve Stem Seals	KIT SET	SHORT BLOCK SET
--------------------	-------------	--	--------------------------------------	---------	-----------------

Ford Trucks, Mini-vans, & SUVs: 4 Cyl

<p>1.8L 109.6 1796cc SOHC L4 Mazda VB Engine, 8 Vlv 1972-78</p> <p>VIN A 1972-1978</p>	<p>HG 950-5 1972-1978 8502</p>	<p>HK 950-5 1972-1978 Exh Man N/I 8502</p>	<p>HS 950-5 1972-1978 Exh Man N/I 8502</p>	<p>KS 950-5 1972-1978 Exh Man N/I 8502</p>	<p>ER 950-5 1972-1978 Exh Man N/I 8502</p>
<p>2.0L 120.2 1970cc SOHC L4 Mazda MB Engine, 8 Vlv 1979-82 Courier VIN 1 1979-1982</p>	<p>HG 950-5 1979-1982 8502</p>	<p>HK 950-5 1979-1982 Exh Man N/I 8502</p>	<p>HS 950-5 1979-1982 Exh Man N/I .500 Guide O.D. For 79 N/I 8502</p>	<p>KS 950-5 1979-1982 Exh Man N/I .500 Guide O.D. For 79 N/I 8502</p>	<p>ER 950-5 1979-1982 Exh Man N/I 8502</p>
<p>2.0L 121 1988cc DOHC L4 Ford Engine, 16 Vlv 2001-04</p> <p>VIN B 2001-2004 ZETEC</p>	<p>HG 538-2 2001-2002 To 7-6-2002 9005 ----- HG 538-3 2002-2004 From 7-7-2002 9005-1</p>	<p>HK 538-6 2002-2004 From 7-7-2002 9005-5 ----- HK 538-12 2001-2002 To 7-6-2002 9005-6</p>	<p>HS 538-6 2002-2004 From 7-7-2002 9005-5 ----- HS 538-12 2001-2002 To 7-6-2002 9005-6</p>	<p>KS 538-6 2002-2004 From 7-7-2002 9005-5 ----- KS 538-12 2001-2002 To 7-6-2002 9005-6</p>	<p>ER</p>

OIL PAN SET	INTAKE MANIFOLD SET	EXHAUST MANIFOLD SET	VALVE COVER SET	TIMING COVER SET	REAR SEAL SET	VALVE STEM SEAL SET
-------------	---------------------	----------------------	-----------------	------------------	---------------	---------------------

Ford Trucks, Mini-vans, & SUVs: 4 Cyl

OP 950-5 1972-1978 30345	MS 950-2 1972-1978 91630	EMS 950-2 1973-1974 & 1974-1978 California 95488 ----- EMS 950-4 1974 Except California 95489 ----- EMS 950-5 1975-78 Except California 95490	VS 950-5 1972-1978 w/Semi Circular Plug/ Cork 50098 ----- VS 950-6 1972-1978 w/Semi Circular Plug /Rubber 50098	TCS 950-5 1972-1978 Crk Frt Seal Set 45442	RS 950-5 1972-1978 40126	SS 950-5 1972-1978 27506
OP 950-5 1979-1982 30345	MS 950-2 1979-1982 91630	EMS 950-5 1979-82 California 95490 ----- EMS 950-6 1979-1982 Exc California 95491	VS 950-5 1979-1982 w/Simi-Circular Plug / Cork 50098 ----- VS 950-6 1979-1982 w/Simi-Circular Plug / Rubber 50098	TCS 950-5 1979-1982 Crank Frt Seal Set 45442	RS 950-5 1979-1982 40126	SS 950-5 1979 To 11-1-78 .500 Guide O.D. 27506 ----- SS 950-6 1979-1982 w/.553 Guide O.D. 72512
OP 538-4 2000-2004 30711	MS 538-4 2000-2004 90891	EMS 538-4 2000-2004 94427	VS 538-5 2000-2004 50553	TCS 538-2 2000-2004 Cam Frt Seal Set 45963 ----- TCS 538-6 Crank Frt Seal Set Use w/ OP 46015	RS 538-5 2000-2004 Radial 40618 ----- RS 519-6 2000-2004 Radial PTFE 40646	SS 538-5 2000-2004 72889



ENGINE INFORMATION	HEAD GASKET	HEAD KIT With <u>NO</u> Valve Stem Seals	HEAD SET With Valve Stem Seals	KIT SET	SHORT BLOCK SET
--------------------	-------------	--	--------------------------------------	---------	-----------------

Ford Trucks, Mini-vans, & SUVs: 4 Cyl

2.0L 122 SOHC L4 Ford Engine, 8 Vlv LD TRUCK 1983-88 VIN C 1983-1988	HG 517-8 1983-1988 9063	HK 517-8 1983-1988 9063-1,-2	HS 517-7 1983-1986 To 7-15-86 9063-1 ----- HS 517-8 1986-1988 From 7-16-86 9063-2	KS 517-7 1983-1986 To 7-15-86 9063-1 ----- KS 517-8 1986-1988 From 7-16-86 OP For 86 N/I 9063-2	ER 517-7 1983-1986 9063-1 ----- ER 517-8 1987-1988 9063-2
2.2L 134.8 2209cc SOHC Diesel L4 Mazda S2 Engine 1983-84 VIN P 1983-1984	HG 907-5 1983-1984 9025	HK 907-5 1983-1984 9025	HS 907-5 1983-1984 9025	KS 907-5 1983-1984 9025	ER 907-5 1983-1984 9025
2.3L 138 2261cc DOHC L4 DURATEC Engine 2001-2008 VIN D 2001-2008 (Duratec) VIN H 2005-2008 (Duratec Hybrld) VIN Z 2005-2008	HG 544-5 2001-2008 26250	HK 544-5 2001-2006 Heat Shield N/I 26250	HS 544-5 2001-2008 Heat Shield N/I 26250	KS 544-5 2001-2008 Heat Shield N/I 26250	ER 544-5 2001-2008 Heat Shield N/I 26250



OIL PAN SET	INTAKE MANIFOLD SET	EXHAUST MANIFOLD SET	VALVE COVER SET	TIMING COVER SET	REAR SEAL SET	VALVE STEM SEAL SET
-------------	---------------------	----------------------	-----------------	------------------	---------------	---------------------

Ford Trucks, Mini-vans, & SUVs: 4 Cyl

<p>OP 517-4 1983-1986 Cork/Rubber 30297 ----- OP 517-7 1987-1988 Rubber 34211</p>	<p>MS 517-8 1983-1988 91617</p>	<p>EMS 517-5 1983-1988 92424</p>	<p>VS 517-5 1983-1988 50126 ----- VS 517-6 1983-1988 Hi-Temp Rubber 50043-1</p>	<p>TCS 517-5 1983-1988 Cam Frt Seal Set 45108 ----- TCS 517-6 Auxiliary Seal 45109 ----- TCS 517-4 Crank Frt. Seal Set 1983-1988 Use OP w/87-88 Application 45107</p>	<p>RS 510-5 1983 2 Piece 30136 ----- RS 510-6 1983-1988 Radial 40620 ----- RS 510-8 1983-1988 Radial PTFE 40644</p>	<p>SS 519-2 1983-1986 To 7-15-85 70037 ----- SS 519-5 1986-1988 From 7-16-86 72683</p>
<p>OP 907-5 1983-1984 30438</p>	<p>MS N/A</p>	<p>EMS 907-5 1983-1984 91516</p>	<p>VS 907-5 1983-1984 50227</p>	<p>TCS 907-5 1983-1984 45549</p>	<p>RS 907-5 1983-1984 40390</p>	<p>SS 907-5 1983-1984 N/A</p>
<p>OP USE RTV</p>	<p>MS 544-2 2001-2008 96634</p>	<p>EMS 544-5 2001-2008 From 2-01-01 96655 ----- EMS 544-4 2001 Heat Shield 96656</p>	<p>VS 544-4 2001-2008 Vin "D" 50638</p>	<p>TCS 544-5 2001-208 Crank Frt Seal Set 46059</p>	<p>RS 544-6 2001-2008 Radial 40689</p>	<p>SS 544-5 2001-2008 72917</p>



ENGINE INFORMATION	HEAD GASKET	HEAD KIT With <u>NO</u> Valve Stem Seals	HEAD SET With Valve Stem Seals	KIT SET	SHORT BLOCK SET
--------------------	-------------	--	--------------------------------------	---------	-----------------

Ford Trucks, Mini-vans, & SUVs: 4 Cyl

2.3L 140 2302cc SOHC L4 WB Engine 1977-97 VIN A 1983-1997 VIN B 1977-1980 VIN 2 1981-1982	HG 517-5 1977-1997 8993-1	HK 517-5 1977-1982 8471-5 ----- HK 517-4 1985 w/MFI 1986 To 7-15-86 8993-2 ----- HK 517-6 1983-1985 w/1 Bbl. carb 1989-1994 8471-6 ----- HK 517-7 1986 From 7-16-86 to 1987 8993-3 ----- HK 517-9 1988 8993-4 ----- HK 517-8 1989-1994 8993-6 ----- HK 517-10 1995-1997 8993-7	HS 517-5 1977-1982 8471-5 ----- HS 517-4 1985 w/MFI 1986 To 7-15-86 8993-2 ----- HS 517-6 1983-1985 w/1 Bbl. carb 1989-1994 8471-6 ----- HS 517-7 1986 From 7-16-86 to 1987 8993-3 ----- HS 517-9 1988 8993-4 ----- HS 517-8 1989-1994 8993-6 ----- HS 517-10 1995-1997 8993-7	KS 517-5 1977-1981 To 9-28-81 8471-5 ----- KS 517-4 1985 w/MFI 1986 To 7-15-86 8993-2	ER 517-5 1977-1981 To 9-28-81 8471-5 ----- ER 517-4 1985 w/MFI 1986 To 7-15-86 8993-2
2.3L 143 2346cc SOHC Turbo Diesel L4 Mitsubishi 4D55-T Engine 1985-87 VIN E 1985-1987	HG 977-5 1985-1987 9045	HK 977-5 1985-1987 9045-1	HS 977-5 1985-1987 9045-1	KS 977-5 1985-1987 9045-1	ER 977-5 1985-1987 9045-1



OIL PAN SET	INTAKE MANIFOLD SET	EXHAUST MANIFOLD SET	VALVE COVER SET	TIMING COVER SET	REAR SEAL SET	VALVE STEM SEAL SET
-------------	---------------------	----------------------	-----------------	------------------	---------------	---------------------

Ford Trucks, Mini-vans, & SUVs: 4 Cyl

<p>OP 517-4 1977-1985 To 4-8-85 30297 -----</p> <p>OP 517-9 1985 From 4-9-85 To 1992 I Pc. Silicone 30545 -----</p> <p>OP 517-10 1993-1997 I Pc. Silicone 30914</p>	<p>MS 517-5 1977-1982 1985-1987 w/MFI Upper & Lower Set 90266-1 -----</p> <p>MS 517-9 1983-1985 w/1 Bbl. Carb 91617 -----</p> <p>MS 517-10 1988-1994 Upper & Lower Set 93361 -----</p> <p>MS 517-12 1995-1997 Upper & Lower Set 93361-1</p>	<p>EMS 517-5 1977-1997 92424</p>	<p>VS 517-5 1984-1988 1985-1988 Use w/MS 50126 -----</p> <p>VS 517-6 1985-1994 Upper & Lower Intake Included 50043-1 -----</p> <p>VS 517-8 1995-1997 Upper & Lower Intake Included 50043-2</p>	<p>TCS 517-5 1977-1997 Cam Frt Seal Set 45108 -----</p> <p>TCS 517-6 1977-1997 Auxiliary Seal 45109 -----</p> <p>TCS 517-4 1977-1992 Use OP w/85-92 Application Crank Frt. Seal Set 45107 -----</p> <p>TCS 517-8 1993-1997 Crank Frt. Seal Set Use w/OP 45940</p>	<p>RS 510-5 1977-1981 To 9-28-81 30136 -----</p> <p>RS 510-6 1981-1997 From 9-29-81 Radial 40620 -----</p> <p>RS 510-8 1981-1997 From 9-29-81 Radial PTFE 40644</p>	<p>SS 517-6 1977-1982 70373 -----</p> <p>SS 519-2 1983-1986 To 7-15-86 70037 -----</p> <p>SS 519-5 1986-1994 From 7-16-86 72683 -----</p> <p>SS 517-8 1995-1997 72875</p>
<p>OP 407-5 1985-1987 30400</p>	<p>MS 977-5 1985-1987 91719-1</p>	<p>USE MS</p>	<p>VS 977-5 1985-1987 50100</p>	<p>TCS 977-5 1985-1987 Cam Frt Seal Set 45483 -----</p> <p>TCS 977-6 1985-1987 Crank Frt Seal Set 45564-1</p>	<p>RS 977-5 1985-1987 Radial 40444</p>	<p>SS 402-5 1985-1987 70702</p>



ENGINE INFORMATION	HEAD GASKET	HEAD KIT With <u>NO</u> Valve Stem Seals	HEAD SET With Valve Stem Seals	KIT SET	SHORT BLOCK SET
--------------------	-------------	--	--------------------------------------	---------	-----------------

Ford Trucks, Mini-vans, & SUVs: 4 Cyl

2.5L 153 2503cc SOHC L4 Ford Engine, 8 Vlv 1998-2001 VIN C 1998-2001 HEAD BOLTS RECOMMENDED	HG 517-5 1998-2001 8993-1 Head Bolts HB 517-5 1998-2001 72137	HK 517-10 1998 8993-7 ----- HK 517-5 1999-2001 8993-8	HS 517-10 1998 8993-7 ----- HS 517-5 1999-2001 8993-8	KS 517-10 1998 8993-7 ----- KS 517-5 1999-2001 8993-8	ER 517-10 1998 8993-7 ----- ER 517-5 1999-2001 8993-8
3.3L 200 L-HEAD L4 MODEL A & B Ford Engine, 12 Vlv 1924-1934	HG 539-2 1924-1934 Copper 7013	HK N/A	HS N/A	KS 539-2 1928-1931 7013 ----- KS 539-4 1932-1934 7014	ER N/A

Ford Trucks, Mini-vans, & SUVs: 6 Cyl

2.4L 144 OHV L6 Ford Engine, 12 Vlv 1960-64 VIN D 1960-1962 VIN S 1960-1966	HG 503-3 1960-1966 7916-1	HK 503-3 1960-1966 7916-2	HS 503-3 1960-1966 7916-2	KS 503-3 1960-1966 7916-2	ER 503-3 1960-1966 7916-2
2.8L 170 OHV L6 Ford Engine, 12 Vlv 1961-72 VIN F 1966-1972 VIN U 1961-1965	HG 503-3 1961-1972 7916-1	HK 503-3 1961-1972 7916-2	HS 503-3 1961-1972 7916-2	KS 503-3 1961-1972 7916-2	ER 503-3 1961-1972 7916-2
2.8L 171 2792cc OHV V6 12 Vlv 1983-86 VIN S 1983-1986 HEAD BOLTS RECOMMENDED	HG 509-1R 1983-1986 Right Side 9132 ----- HG 509-2L 1983-1986 Left Side 9136	HK 509-8 1983-1986 86 Aerostar Exhaust Man N/I 9132-1	HS 509-8 1983-1986 86 Aerostar Exhaust Man N/I 9132-1	KS 509-8 1983-1986 86 Aerostar Exhaust Man N/I 9132-1	ER 509-8 1983-1986 86 Aerostar Exhaust Man N/I 9132-1

OIL PAN SET	INTAKE MANIFOLD SET	EXHAUST MANIFOLD SET	VALVE COVER SET	TIMING COVER SET	REAR SEAL SET	VALVE STEM SEAL SET
-------------	---------------------	----------------------	-----------------	------------------	---------------	---------------------

Ford Trucks, Mini-vans, & SUVs: 4 Cyl

OP 517-10 1998-2001 1 Pc. Silicone 30914	MS 517-12 1998-2001 Upper & Lower 93391-1 ----- MS 517-14 1998-2001 Upper 95737	EMS 517-5 1998-2001 92424	VS 517-8 1998-2001 1 Pc. Silicone 50043-2	TCS 517-5 1998-2001 Cam Frt Seal Set 45108 ----- TCS 517-6 1998-2001 Auxiliary Seal 45109 ----- TCS 517-8 1998-2001 Crank Frt. Seal Set Use w/OP 45940	RS 510-6 1998-2001 Radial 40620 ----- RS 510-8 1998-2001 Radial PTFE 40644	SS 517-8 1998 72875 ----- SS 517-10 1999-2001 70864
OP 539-2 1928-1931 30912-1	MS 539-2 1928-1934 2388	EMS USE MS	VS N/A	TCS N/A	RS N/A	SS N/A

Ford Trucks, Mini-vans, & SUVs: 6 Cyl

OP 503-3 1960-1966 12701	MS 503-3 1960-1966 9789-1	USE MS	VS 503-3 1960-1966 12692	TCS 503-3 1960-1966 13059-1	RS 503-5 1960-1966 30135	SS 503-5 1960-1966 72616
OP 503-3 1961-1972 12701	MS 503-3 1961-1972 9789-1	USE MS	VS 503-3 1961-1972 12692	TCS 503-3 1961-1972 13059-1	RS 503-5 1961-1972 30135	SS 503-5 1961-1972 72616
OP 509-5 1983-1986 30271	MS 509-6 1983-1986 91886	EMS 509-6 1983-1986 Exc. Aerostar 91887 ----- EMS 509-8 1986 Aerostar 92734	VS 509-5 1983-1986 50115	TCS 509-6 1983-1986 45586	RS 509-8 1983-1986 Radial 40419	SS 509-5 1983-1986 72686



ENGINE INFORMATION	HEAD GASKET	HEAD KIT With <u>NO</u> Valve Stem Seals	HEAD SET With Valve Stem Seals	KIT SET	SHORT BLOCK SET
--------------------	-------------	--	--------------------------------------	---------	-----------------

Ford Trucks, Mini-vans, & SUVs: 6 Cyl

<p>2.9L 177 2935cc OHV V6 12 Vlv 1986-92</p> <p>VIN T 1986-92</p>	<p>HG 524-1R 1986-1992 Right Side 9510 ----- HG 524-2L 1986-1992 Left Side 9511</p> <p>Head Bolts HB 524-5 1986-1992 72794</p>	<p>HK 524-5 1986-1992 9510-2</p>	<p>HS 524-5 1986-1992 9510-2</p>	<p>KS 524-5 1986-1992 9510-2</p>	<p>ER 524-5 1986-1992 9510-2</p>
<p>3.0L 181 2960cc SOHC V6 Nissan VG30E Engine, 12 Vlv 1993-98</p> <p>VIN W 1993-1996 VIN 1 1997-1998</p>	<p>HG 529-5 1993-1998 9571</p>	<p>HK 529-2 1993 9571-3 ----- HK 529-4 1994-1998 9972</p>	<p>HS 529-2 1993 9571-3 ----- HS 529-4 1994-1998 9972</p>	<p>KS 529-2 1993 9571-3 ----- KS 529-4 1994-1998 9972</p>	<p>ER 529-2 1993 9571-3 ----- ER 529-4 1994-1998 9972</p>
<p>3.0L 181 2966cc DOHC V6 24 Vlv 2001-2005</p> <p>VIN 1 2001-2005 DURATEC</p> <p>HEAD BOLTS RECOMMENDED</p>	<p>HG 528-4R 01 to 12/14/03 9541 54363 ----- HG 528-5L 01 to 12/14/03 9540 54364</p> <p>Head Bolts HB 528-5 2001-2005 (2) REQ'D 72159</p>	<p>HK 528-9 2001-2003 9540-3</p>	<p>HS 528-9 2001-2003 9540-3</p>	<p>KS 528-9 2001-2003 9540-3</p>	<p>ER 528-9 2001-2003 9540-3</p>



OIL PAN SET	INTAKE MANIFOLD SET	EXHAUST MANIFOLD SET	VALVE COVER SET	TIMING COVER SET	REAR SEAL SET	VALVE STEM SEAL SET
-------------	---------------------	----------------------	-----------------	------------------	---------------	---------------------

Ford Trucks, Mini-vans, & SUVs: 6 Cyl

<p>OP 509-5 1986 To 10-15-85 Cork/Rubber 30271 ----- OP 524-5 1986-1992 From 10-16-85 Silicone 30571</p>	<p>MS 524-5 1986-1992 Upper & Lower 93771 ----- MS 524-6 1986-1992 Upper Set 93754</p>	<p>EMS 524-5 1986-1992 93849</p>	<p>VS 524-5 1986-1992 50312</p>	<p>TCS 524-5 1986-1993 Use w/OP 45791</p>	<p>RS 509-8 1986-1992 Radial 40419</p>	<p>SS 509-5 1986-1992 72686</p>
<p>OP 529-5 1993-1998 RTV w/Rubber End Seals 30591</p>	<p>MS 529-5 1993-1998 92270-1</p>	<p>EMS 529-4 1993 92272 ----- EMS 529-5 1994-1998 95583</p>	<p>VS 529-5 1993-1998 w/Grommets 50251-1</p>	<p>TCS 529-2 1993-1998 Cam Frt Seal Set 45635x2 ----- TCS 529-4 1993-1998 Crk Frt Seal Set 45935</p>	<p>RS 529-5 1993-1998 Radial 40628</p>	<p>SS 509-5 1993-1998 72868</p>
<p>OP 528-2 2001-2003 30697 ----- OP 528-4 2004-2005 30729</p>	<p>MS 528-8 2001-2004 Upper & Lower 96124 ----- MS 528-9 2005 Upper & Lower 92586-1 ----- MS 528-7 2001-2004 Upper Set 96124-1 ----- MS 528-12 2005 Upper Set 96252</p>	<p>EMS 542-5 2001-2005 95715</p>	<p>VS 528-5 2001-2004 W/Grommets & Spark Plug Seals 50551 50336 ----- VS 528-7 2005 W/Grommets & Spark Plug Seals 50579</p>	<p>TCS 542-6 2001-2004 Crk Frt Seal Set Use w/Oil Pan 45967 ----- TCS 528-5 2005 Crk Frt Seal Set Use w/Oil Pan 46016</p>	<p>RS 510-6 2001-2005 Radial 40620 ----- RS 510-8 2001-2005 Radial PTFE 40644</p>	<p>SS 528-5 2001-2005 72873-1</p>



OIL PAN SET	INTAKE MANIFOLD SET	EXHAUST MANIFOLD SET	VALVE COVER SET	TIMING COVER SET	REAR SEAL SET	VALVE STEM SEAL SET
-------------	---------------------	----------------------	-----------------	------------------	---------------	---------------------

Ford Trucks, Mini-vans, & SUVs: 6 Cyl

OP 521-1 1986-1990 To 3-26-89 34505	MS 521-1 1986-1990 Upper & Lower 95372 ----- MS 521-6 1986-1990 Upper Set 93491	EMS 521-4 1986-1990 93850	VS 521-1 1986-90 50066	TCS 521-1 1986-1990 Use w/ OP 45771	RS 501-2 1986-1990 Radial 40158 ----- RS 521-6 1986-1990 Radial PTFE 40646	SS 082-6 1986-1990 To 7/26/99 8 mm 70819
--	---	---------------------------------	------------------------------	--	--	--



OIL PAN SET	INTAKE MANIFOLD SET	EXHAUST MANIFOLD SET	VALVE COVER SET	TIMING COVER SET	REAR SEAL SET	VALVE STEM SEAL SET
-------------	---------------------	----------------------	-----------------	------------------	---------------	---------------------

Ford Trucks, Mini-vans, & SUVs: 6 Cyl

<p>OP 521-2 1990-2001 From 3-27-89 30717 ----- OP 521-5 2002-2008 30712</p>	<p>MS 521-1 1991-2001 Upper & Lower 95372 ----- MS 521-6 1991-2001 Upper Set 93491 ----- MS 521-5 2002-2008 Upper & Lower 95372-1 ----- MS 521-8 2002-2008 Upper Set 94429</p>	<p>EMS 521-4 1991-1995 93850 ----- EMS 521-5 1996-2008 95939</p>	<p>VS 521-1 1991 Aerostar Eng. Code 1G-576, 577-BA 50066 ----- VS 521-2 1991 Aerostar Eng. Code 1G-576, 577-AA, CA & 1992-2008 50374</p>	<p>TCS 521-1 1991-2008 Use w/ OP 45771</p>	<p>RS 501-2 1991-2008 Radial 40158 ----- RS 519-6 1991-2008 Radial PTFE 40646</p>	<p>SS 082-6 1991-1999 To 7/26/99 8 mm 70819 ----- SS 521-7 1999-2008 From 7/27/99 7 mm 70964</p>
<p>OP 503-3 1964-1974 12701</p>	<p>MS 503-3 1964-1974 9789-1</p>	<p>EMS USE MS</p>	<p>VS 503-3 1964-1974 12692</p>	<p>TCS 503-3 1964-1974 13059-1</p>	<p>RS 503-5 1964-1974 30135</p>	<p>SS 503-3 1964-1974 72616</p>



ENGINE INFORMATION	HEAD GASKET	HEAD KIT With <u>NO</u> Valve Stem Seals	HEAD SET With Valve Stem Seals	KIT SET	SHORT BLOCK SET
--------------------	-------------	--	--------------------------------------	---------	-----------------

Ford Trucks, Mini-vans, & SUVs: 6 Cyl

3.8L 232 OHV V6 Ford Engine 12 vlv 1982-83 VIN C 1982-1983 VIN 3 1982-1983	HG 518-5 1982-1983 8857-1 ----- Head Bolts HB 518-5 1982-1983 (2 Req'd) 72129	HK 518-2 1982-1983 8857	HS 518-2 1982-1983 8857	KS 518-2 1982-1983 8857-1	ER 518-2 1982-1983 8857-1
--	---	-------------------------------	-------------------------------	---------------------------------	---------------------------------



OIL PAN SET	INTAKE MANIFOLD SET	EXHAUST MANIFOLD SET	VALVE COVER SET	TIMING COVER SET	REAR SEAL SET	VALVE STEM SEAL SET
-------------	---------------------	----------------------	-----------------	------------------	---------------	---------------------

Ford Trucks, Mini-vans, & SUVs: 6 Cyl

OP 518-5 1982-1983 34000	MS 518-2 1982-1983 91240	EMS 518-5 1982-1983 91346	VS 518-5 1982-1983 50212 ----- VS 518-7 1982-1983 K-Cork 50212	TCS 518-5 1982-1983 45521	RS 510-5 1982-1983 2 Pc. Rubber 30136	SS 518-5 1982-1983 72654/72561-1
--------------------------------	--------------------------------	---------------------------------	---	---------------------------------	--	--



ENGINE INFORMATION	HEAD GASKET	HEAD KIT With <u>NO</u> Valve Stem Seals	HEAD SET With Valve Stem Seals	KIT SET	SHORT BLOCK SET
--------------------	-------------	--	--------------------------------------	---------	-----------------

Ford Trucks, Mini-vans, & SUVs: 6 Cyl

3.8L 232 OHV V6 Ford Engine, 12 Vlv 1995-2003 VIN 4 1995-2003 L/D TRUCK	HG 518-8 1995 9560 ----- HG 518-6 1996 9234 ----- HG 518-3R 1997-2003 Right Hand 9253 ----- HG 518-4L 1997-2003 Left Hand 9250	HK 518-11 1995 9560PT-2 ----- HK 518-18 1996 w/3mm thick Intake 9234 ----- HK 518-19 1996 w/4mm thick Intake 9234-1 ----- HK 518-22 1997-1999 w/4mm thick Intake to 12/31/98 9250-3 ----- HK 518-23 1999-2003 From 1/1/99 9250-4	HS 518-11 1995 9560PT-2 ----- HS 518-18 1996 w/3mm thick Intake 9234 ----- HS 518-19 1996 w/4mm thick Intake 9234-1 ----- HS 518-22 1997-1999 w/4mm thick Intake to 12/31/98 9250-3 ----- HS 518-23 1999-2003 From 1/1/99 9250-4	KS 518-11 1995 9560PT-2 ----- KS 518-18 1996 w/3mm thick Intake 9234 ----- KS 518-19 1996 w/4mm thick Intake 9234-1 ----- KS 518-22 1997-1999 w/4mm thick Intake to 12/31/98 9250-3 ----- KS 518-23 1999-2003 From 1/1/99 9250-4	ER 518-11 1995 9560PT-2 ----- ER 518-18 1996 w/3mm thick Intake 9234 ----- ER 518-19 1996 w/4mm thick Intake 9234-1 ----- ER 518-22 1997-1999 w/4mm thick Intake to 12/31/98 9250-3 ----- ER 518-23 1999-2003 From 1/1/99 9250-4
HEAD BOLTS RECOMMENDED	Head Bolts HB 518-6 1995 (2 Req'd) 72131 ----- HB 518-7 1996-1997 (2 Req'd) 72156 ----- HB 518-8 1998-2003 (2 Req'd) 72160				



OIL PAN SET	INTAKE MANIFOLD SET	EXHAUST MANIFOLD SET	VALVE COVER SET	TIMING COVER SET	REAR SEAL SET	VALVE STEM SEAL SET
-------------	---------------------	----------------------	-----------------	------------------	---------------	---------------------

Ford Trucks, Mini-vans, & SUVs: 6 Cyl

<p>OP 518-9 1995-2000 RTV & Rubber End Seals 30625 ----- OP 518-10 2001-2003 RTV & Rubber End Seals 30702</p>	<p>MS 518-6 1995 Upper & Lower Set 94045 ----- MS 518-12 1996-1998 to 1/14/98 3mm Thick Upper & Lower Set 95932 ----- MS 518-14 1996-1999 To 12/31/98 4mm Thick Upper & Lower Set 95985-1 ----- MS 518-15 1999-2003 From 1/1/99 Upper & Lower Set 95985-2 ----- MS 518-7 1995 Upper Set 94046 ----- MS 518-11 1996-1998 Upper Set 95934 ----- MS 518-19 1999-2003 Upper Set 90812 ----- TB 518-6 Throttle Body 1997-2004 O-RING & GASKET SET 61046/60913</p>	<p>EMS 518-5 1995 91346 ----- EMS 518-7 1996-2003 95968</p>	<p>VS 518-9 1996-2003 wo /Grommets 50441</p>	<p>TCS 518-9 1995-1998 45951 ----- TCS 518-10 1999-2003 45984</p>	<p>RS 510-6 1996-2003 40620 ----- RS 510-8 1996-2003 Radial PTFE 40644</p>	<p>SS 518-8 1995 72708 ----- SS 518-6 1996-1998 72875-1 ----- SS 518-9 1999-2003 70864-1</p>
---	--	---	--	---	--	--



ENGINE INFORMATION	HEAD GASKET	HEAD KIT With <u>NO</u> Valve Stem Seals	HEAD SET With Valve Stem Seals	KIT SET	SHORT BLOCK SET
--------------------	-------------	--	--------------------------------------	---------	-----------------

Ford Trucks, Mini-vans, & SUVs: 6 Cyl

<p>3.9L 238 OHV V6 Ford Engine, 12 Vlv 2004-2007</p> <p>VIN 6 2004-2007</p> <p>L/D TRUCK</p> <p>HEAD BOLT REPLACEMENT RE- QUIRED</p>	<p>HG 518-3R 2004-2006 Right Hand 9253 -----</p> <p>HG 518-4L 2004-2006 Left Hand 9250 -----</p> <p>Head Bolts HB 518-8 2004-2006 (2 Req'd) 72160</p>	<p>HK 518-27 2004 9250-6 -----</p> <p>HK 518-28 2005-2007 9250-7</p>	<p>HS 518-27 2004 9250-6 -----</p> <p>HS 518-28 2005-2007 9250-7</p>	<p>KS 518-27 2004 9250-6 -----</p> <p>KS 518-28 2005-2007 9250-7</p>	<p>ER 518-27 2004 9250-6 -----</p> <p>ER 518-28 2005-2007 9250-7</p>
<p>3.9L 240 OHV L6 Ford Engine, 12 Vlv 1965-76</p> <p>VIN A 1966-1976 VIN J 1965 VIN 1 1972-1976</p> <p>L/D TRUCK</p>	<p>HG 511-5 1965-1976 8168</p>	<p>HK 511-5 1965-1976 VC for 1965-67 Not Included 8168-3</p>	<p>HS 511-5 1965-1976 VC for 1965-67 Not Included 8168-3</p>	<p>KS 511-5 1965-1976 VC for 1965-67 Not Included 8168-3</p>	<p>ER 511-5 1965-1976 VC for 1965-67 Not Included 8168-3</p>



OIL PAN SET	INTAKE MANIFOLD SET	EXHAUST MANIFOLD SET	VALVE COVER SET	TIMING COVER SET	REAR SEAL SET	VALVE STEM SEAL SET
-------------	---------------------	----------------------	-----------------	------------------	---------------	---------------------

Ford Trucks, Mini-vans, & SUVs: 6 Cyl

<p>OP 518-10 2004-2007 30702</p>	<p>MS 518-16 2004 Upper & Lower Set 95985-3 ----- MS 518-20 2004-2007 Upper Set 96239</p>	<p>EMS 518-7 2004-2007 95968</p>	<p>VS 518-9 2004-2007 w/o Grommets 50441</p>	<p>TCS 518-10 2004-2007 45984</p>	<p>RS 510-6 2004-2007 Radial 40620 ----- RS 510-8 2004-2007 Radial PTFE 40644</p>	<p>SS 518-9 2004-2007 70864-1</p>
<p>OP 511-5 1965-1976 13811</p>	<p>MS 511-5 1965-1976 90157-1</p>	<p>USE MS</p>	<p>VS 511-2 1965-1967 Not Supplied In Kits 13799 ----- VS 511-5 1968-76 50033 ----- PS 511-5 Push Rod Cover w/Grommet 13809</p>	<p>TCS 511-5 1965-1976 45044</p>	<p>RS 511-5 1965-1976 Radial 40509</p>	<p>SS 511-5 1965-1976 13807</p>



ENGINE INFORMATION	HEAD GASKET	HEAD KIT With <u>NO</u> Valve Stem Seals	HEAD SET With Valve Stem Seals	KIT SET	SHORT BLOCK SET
--------------------	-------------	--	--------------------------------------	---------	-----------------

Ford Trucks, Mini-vans, & SUVs: 6 Cyl

4.0L 244 4015cc OHV V6 1990-2001 VIN X 1990-2001 L/D TRUCK	HG 532-2R Right Side 1990-2001 9725-2 ----- HG 532-4L Left Side 1990-2001 9724-2	HK 532-2 1990-1994 9724-1 ----- HK 532-4 1995-1996 9081 ----- HK 532-5 1997-2001 9081-1	HS 532-2 1990-1994 9724-1 ----- HS 532-4 1995-1996 9081 ----- HS 532-5 1997-2001 9081-1	KS 532-2 1990-1994 9724-1 ----- KS 532-4 1995-1996 9081 ----- KS 532-5 1997-2001 9081-1	ER 532-2 1990-1994 9724-1 ----- ER 532-4 1995-1996 9081 ----- ER 532-5 1997-2001 9081-1
HEAD BOLTS RECOMMENDED	Head Bolts HB 524-5 1990-2001 72794				



OIL PAN SET	INTAKE MANIFOLD SET	EXHAUST MANIFOLD SET	VALVE COVER SET	TIMING COVER SET	REAR SEAL SET	VALVE STEM SEAL SET
-------------	---------------------	----------------------	-----------------	------------------	---------------	---------------------

Ford Trucks, Mini-vans, & SUVs: 6 Cyl

<p>OP 532-2 1990-1993 30634 ----- OP 532-4 1994-2001 34309</p>	<p>MS 532-2 1990-1994 Upper & Lower Set 94682 ----- MS 532-3 1995 Upper & Lower Set 94682-1 ----- MS 532-4 1996 Lower Set Use w/VS 95739 ----- MS 532-5 1997-2001 Lower Set Use w/VS 90728 ----- MS 532-6 1990-1995 Upper Set 94683 ----- MS 532-7 1996-1997 Upper Set 90733 ----- MS 532-8 1998-2001 Upper Set 90732 ----- MS 532-10 1990-1997 Complete Set Up-Lwr Int & Valve Cover 98005 ----- MS 532-12 1998-2001 Complete Set Up-Lwr Int & Valve Cover 98006</p>	<p>EMS 532-4 1990-1996 94764 ----- EMS 532-5 1997-2001 95960</p> <p>THROTTLE BODY TB 532-2 O-Ring 1995-2001 61055</p>	<p>VS 532-2 1990-1995 Intake Upper Set Included 50368 ----- VS 532-4 1996-2001 Intake Upper Set Not Included 50368</p>	<p>TCS 532-5 1990-2001 Use w/OIL PAN 45867</p>	<p>RS 509-8 1990-1994 40419 ----- RS 532-5 1995-2001 40619</p>	<p>SS 509-5 1990-2001 72686</p>
--	---	---	--	--	--	---



ENGINE INFORMATION	HEAD GASKET	HEAD KIT With <u>NO</u> Valve Stem Seals	HEAD SET With Valve Stem Seals	KIT SET	SHORT BLOCK SET
--------------------	-------------	--	--------------------------------------	---------	-----------------

Ford Trucks, Mini-vans, & SUVs: 6 Cyl

<p>4.0L 244 4015cc SOHC V6 1997-2007</p> <p>VIN E 1997-2007 VIN K 2000-2006 (Flex Fuel)</p> <p>L/D TRUCK</p> <p>HEAD BOLT REPLACEMENT RE- QUIRED</p>	<p>HG 535-2R Right Side 1997-2003 & 2004 Ranger 9294 ----- HG 535-4L Left Side 1997-2003 & 2004 Ranger 9293</p> <p>Head Bolts HB 535-5 1997-2006 (2 Req'd) 72171</p>	<p>HK 535-2 1997-2001 To 7/23/2000 9293 ----- HK 535-3 2001 From 7/24/2000 9293-1 ----- HK 535-4 2002 ALL & 2003 Ranger 9293-2</p>	<p>HS 535-2 1997-2001 To 7/23/2000 9293 ----- HS 535-3 2001 From 7/24/2000 9293-1 ----- HS 535-4 2002 ALL & 2003 Ranger 9293-2</p>	<p>KS 535-2 1997-2001 To 7/23/2000 9293 ----- KS 535-3 2001 From 7/24/2000 9293-1 ----- KS 535-4 2002 ALL & 2003 Ranger 9293-2</p>	<p>ER 535-2 1997-2001 To 7/23/2000 9293 ----- ER 535-3 2001 From 7/24/2000 9293-1 ----- ER 535-4 2002 ALL & 2003 Ranger 9293-2</p>
<p>4.1L 250 OHV L6 Ford Engine, 12 Vlv 1969-74</p> <p>VIN L 1969-1974</p> <p>L/D TRUCK</p>	<p>HG 503-3 1969-1974 7916PT</p>	<p>HK 503-3 1969-1974 7916PT-2</p>	<p>HS 503-3 1969-1974 7916PT-2</p>	<p>KS 504-0 1969-1974 7916PT-3</p>	<p>ER 504-0 1969-1974 7916PT-3</p>



OIL PAN SET	INTAKE MANIFOLD SET	EXHAUST MANIFOLD SET	VALVE COVER SET	TIMING COVER SET	REAR SEAL SET	VALVE STEM SEAL SET
-------------	---------------------	----------------------	-----------------	------------------	---------------	---------------------

Ford Trucks, Mini-vans, & SUVs: 6 Cyl

OP 535-2 1997-2004 Lower Set 30687 ----- OP 532-4 1997-2004 Upper Set 34309	MS 535-2 1997-2001 Upper & Lower Set 90890 ----- MS 535-4 2000-2003 Lower Set & 2004 Explorer, Sport Trac, Mountaineer 96123 ----- TB 535-2 Throttle Body 1997-2001 O-Ring & Gasket Set 61056/61057	EMS 535-2 1997-2004 90779	VS 535-2 1997-2001 To 7/20/2000 50491 ----- VS 535-4 2001-2002 From 7/24/2000 & 2003-2004 Ranger w/Grommets 50529	TCS 535-2 1997-2004 45986	RS 532-5 1997-2004 Radial 40619	SS 535-5 1997-2004 70858
OP 504-0 1969-1974 30217	MS 503-3 1969-1974 9789-1	USE MS	VS 503-3 1969-1974 12692	TCS 504-0 1969-1974 45059	RS 510-5 1969-1974 2 Pc. Rubber 30136	SS 503-5 1969-1974 72616



ENGINE INFORMATION	HEAD GASKET	HEAD KIT With <u>NO</u> Valve Stem Seals	HEAD SET With Valve Stem Seals	KIT SET	SHORT BLOCK SET
--------------------	-------------	--	--------------------------------------	---------	-----------------

Ford Trucks, Mini-vans, & SUVs: 6 Cyl

<p>4.2L 256 OHV V6 Ford Engine, 12 Vlv 1997-2008</p> <p>VIN 2 1997-2008</p> <p>HEAD BOLTS RECOMMENDED</p>	<p>HG 518-3R 1997-2004 RIGHT HAND 9253 ----- HG 518-4L 1997-2004 LEFT HAND 9250</p> <p>Head Bolts HB 518-8 1997-2006 (2 Req'd) 72160</p>	<p>HK 518-26 1997-1998 TO 1/14/98 Upper Set Not In Kit 9250 ----- HK 518-17 1998 FROM 1/15/98 1999-2000 9250-2 ----- HK 518-25 2001-2003 & 2004 E150, F150 9250-5 ----- HK 518-27 2004 Freestar Monterey 9250-6 ----- HK 518-28 2005-2008 9250-7</p>	<p>HS 518-26 1997-1998 TO 1/14/98 Upper Set Not In Kit 9250 ----- HS 518-17 1998 FROM 1/15/98 1999-2000 9250-2 ----- HS 518-25 2001-2003 & 2004 E150, F150 9250-5 ----- HS 518-27 2004 Freestar Monterey 9250-6 ----- HS 518-28 2005-2008 9250-7</p>	<p>KS 518-26 1997-1998 TO 1/14/98 Upper Set Not In Kit 9250 ----- KS 518-17 1998 FROM 1/15/98 1999-2000 9250-2 ----- KS 518-25 2001-2003 & 2004 E150, F150 9250-5 ----- KS 518-27 2004 Freestar Monterey 9250-6 ----- KS 518-28 2005-2008 9250-7</p>	<p>ER 518-26 1997-1998 TO 1/14/98 Upper Set Not In Kit 9250 ----- ER 518-17 1998 FROM 1/15/98 1999-2000 9250-2 ----- ER 518-25 2001-2003 & 2004 E150, F150 9250-5 ----- ER 518-27 2004 Freestar Monterey 9250-6 ----- ER 518-28 2005-2008 9250-7</p>
<p>4.9L 300 OHV L6 Ford Engine, 12 Vlv 1965-97</p> <p>VIN B 1965-1986 VIN C 1978 VIN E 1980-1982 VIN K 1978-1979 VIN Y 1983-1997 VIN Z 1994-1997 (Flex Fuel) VIN 9 1990-1996</p> <p>L/D TRUCK</p>	<p>HG 511-5 1965-1997 8168 ----- HG 511-6 1965-1997 H D 525</p>	<p>HK 511-5 1965-86 VC FOR 65-67 NOT IN KIT 8168-3 ----- HK 511-6 1987 8168-4 ----- HK 511-8 1988-1997 8168-5/6/7</p>	<p>HS 511-5 1965-86 VC FOR 65-67 NOT IN KIT 8168-3 ----- HS 511-6 1987 8168-4 ----- HS 511-8 1988-1991 To 2/2/91 8168-5 ----- HS 511-9 1991-1992 From 2/3/91 8168-6 ----- HS 511-10 1993-1997 8168-7</p>	<p>KS 511-5 1965-86 VC FOR 65-67 NOT IN KIT 8168-3 ----- KS 511-6 1987 8168-4 ----- KS 511-8 1988-1991 To 2/2/91 8168PT-5 ----- KS 511-9 1991-1992 From 2/3/91 8168-6 ----- KS 511-10 1993-1997 8168-7</p>	<p>ER 511-5 1965-86 VC FOR 65-67 NOT IN KIT 8168-3 ----- ER 511-6 1987 8168-4 ----- ER 511-8 1988-1991 To 2/2/91 8168PT-5 ----- ER 511-9 1991-1992 From 2/3/91 8168-6 ----- ER 511-10 1993-1997 8168--7</p>

OIL PAN SET	INTAKE MANIFOLD SET	EXHAUST MANIFOLD SET	VALVE COVER SET	TIMING COVER SET	REAR SEAL SET	VALVE STEM SEAL SET
-------------	---------------------	----------------------	-----------------	------------------	---------------	---------------------

Ford Trucks, Mini-vans, & SUVs: 6 Cyl

<p>OP 518-9 1997-2000 RTV & Rubber End Seals 30625 -----</p> <p>OP 518-10 2001-2008 RTV & Rubber End Seals 30702</p>	<p>MS 518-10 1997-1998 To 1/14/98 Lower Set 95932-1 -----</p> <p>MS 518-13 1998-2004 From 1/15/98 Lower Set 95985 -----</p> <p>MS 518-9 1997-1998 To 1/30/97 Upper Set 95982 -----</p> <p>MS 518-21 2001-2003 & 2004 E150, F150 Upper Set 94452 -----</p> <p>MS 518-18 1998 From 7-31-97 Upper Set 95981</p>	<p>EMS 518-7 1997-2006 95968</p> <p>INTAKE CONT. MS 518-20 2004 Freestar Monterey 2005-2008 Upper Set 96239 -----</p> <p>MS 518-13 1999-2004 Lower Set 95986 -----</p> <p>MS 518-23 2005-2008 Upper & Lwr Set 96451 -----</p> <p>THROTTLE BODY TB 518-4 1997-2008 O-Ring & Gasket Set 61046/61052</p>	<p>VS 518-9 1997-2008 w/o Grommets 50441-1</p>	<p>TCS 518-10 1997-2008 45984</p>	<p>RS 510-6 1997-2008 Radial 40620 -----</p> <p>RS 510-8 1997-2008 Radial PTFE 40644</p>	<p>SS 518-6 1997-1998 72875-1 -----</p> <p>SS 518-9 1999-2008 70864-1</p>
<p>OP 511-5 1965-1987 13811 -----</p> <p>OP 511-6 1988-1997 Silicone 34601</p>	<p>MS 511-5 1965-1986 Int & Exh. 90157-1 -----</p> <p>MS 511-6 1987-1997 Int & Exh. 93837 -----</p> <p>MS 511-7 1987-1997 PLENUM UPPER SET 93838 -----</p> <p>MS 511-8 1987-1997 INTAKE Upper & Lower Set 95647 -----</p> <p>TB 511-5 Throttle Body 1987-1997 W/EFI 60846</p>	<p>USE MS</p>	<p>VS 511-2 1965-1967 Not In Kits 13799 -----</p> <p>VS 511-5 1968-87 50033-1 -----</p> <p>VS 511-6 1988-1997 Silicone 50028 -----</p> <p>PS 511-5 Push Rod Cvr w/Grommets 13809</p>	<p>TCS 511-5 1965-1985 To 5/14/85 45044 -----</p> <p>TCS 511-6 1985-1987 From 5/15/85 & 1988-1997 Use w/OP 45829</p>	<p>RS 511-5 1965-1986 40509 -----</p> <p>RS 511-6 1987-1997 40592</p>	<p>SS 511-5 1965-1991 To 2/2/91 13807 -----</p> <p>SS 302-5 1965-1970 H.D. Exh. O-Ring 5112 -----</p> <p>SS 511-6 1991-1992 From 2/3/91 & 1993-1997 Intake 72623-1 -----</p> <p>SS 511-8 1993-1997 Exhaust 72839-1</p>



ENGINE INFORMATION	HEAD GASKET	HEAD KIT With <u>NO</u> Valve Stem Seals	HEAD SET With Valve Stem Seals	KIT SET	SHORT BLOCK SET
--------------------	-------------	--	--------------------------------------	---------	-----------------

Ford Trucks, Mini-vans, & SUVs: V8

4.2L 255 OHV V8 Ford Engine, 16 Vlv 1981-82 VIN D 1981-1982 L/D TRUCK	HG 506-8 1981-1982 8704	HK 506-8 1981-1982 Valley Pan N/I 8704-1	HS 506-8 1981-1982 Valley Pan N/I 8704-1	KS 506-8 1981-1982 Valley Pan N/I 8704-1	ER 506-8 1981-1982 Valley Pan N/I 8704-1
4.3L 260 OHV V8 Ford Engine, 16 Vlv 1962-64 VIN F 1962-1964 L/D TRUCK	HG 510-5 1962-1964 8548	HK 510-5 1962-1964 8548-2	HS 510-5 1962-1964 8548-2	KS 510-5 1962-1964 8548-2	ER 510-5 1962-1964 8548-2
4.4L 272 OHV V8 Ford Engine, 16 Vlv 1956-58 VIN B 1957 VIN M 1955-1958 VIN U 1955-1958 L/D TRUCK	HG 507-7 1955-1958 7999	HK 507-7 1955-1958 7999-3	HS 507-7 1955-1958 7999-3	KS 507-7 1955-1958 7999-3	ER 507-7 1955-1958 7999-3



OIL PAN SET	INTAKE MANIFOLD SET	EXHAUST MANIFOLD SET	VALVE COVER SET	TIMING COVER SET	REAR SEAL SET	VALVE STEM SEAL SET
-------------	---------------------	----------------------	-----------------	------------------	---------------	---------------------

Ford Trucks, Mini-vans, & SUVs: V8

<p>OP 510-5 1981-1982 13260</p>	<p>VP 506-8 1980-4/13/81 96035 ----- MS 506-8 From 4/14/81-82 91225</p>	<p>EMS 506-8 1981-1982 91349</p>	<p>VS 510-5 1981-1982 13264 ----- VS 510-7 1981-1982 Steel/Silicone Hi Perf 13264</p>	<p>TCS 506-3 1981-1982 45449</p>	<p>RS 510-5 1981-1982 30136</p>	<p>SS 510-5 1981-1982 13364</p>
<p>OP 510-5 1962-1964 13260</p>	<p>MS 510-5 1962-1964 90103-1</p>	<p>EMS 510-5 1962-1964 90000</p>	<p>VS 510-5 1962-1964 13264 ----- VS 510-7 1962-1964 Steel/Silicone High Perf 13264</p>	<p>TCS 510-5 1962-1964 45008</p>	<p>RS 510-5 1962-1964 30136</p>	<p>SS 510-5 1962-1964 13364</p>
<p>OP 507-7 1955-1958 10701-1</p>	<p>MS 507-7 1955-1958 9361-1</p>	<p>EMS 507-5 1955-1958 9492</p>	<p>VS 507-5 1956-1958 w/Grommets 10680</p>	<p>TCS 507-7 1955-1958 10677-3</p>	<p>RS 507-7 1955-1958 Rope 10743 ----- RS 507-8 1955-1958 2 pc Rubber 6141</p>	<p>SS 507-5 1955-1958 10777</p>

OIL PAN SET	INTAKE MANIFOLD SET	EXHAUST MANIFOLD SET	VALVE COVER SET	TIMING COVER SET	REAR SEAL SET	VALVE STEM SEAL SET
-------------	---------------------	----------------------	-----------------	------------------	---------------	---------------------

Ford Trucks, Mini-vans, & SUVs: V8

<p>OP 525-5 1997-2003 34307 30725</p> <p>Oil Filter Adapter 63274 1997-2003 w/Oil Cooler 70801</p>	<p>MS 525-3 1997-1999 Upper & Lower Set 95728-1 ----- MS 525-20 2000 Upper & Lower Set 92121-1 ----- MS 525-18 2001-2003 Upper & Lower Set 92121-2 -----</p> <p>Throttle Body Set TB 525-2 1997-2004 w/MFI Housing to Spacer & Spacer to Manifold 61048/61050</p>	<p>EMS 525-5 1997-2004 92568 ----- EMS 525-6 2006-2008 VIN 6 96679</p>	<p>VS 525-2 1997-2001 w/Grommets VIN W 50377 ----- VS 525-3 1997-2004 VIN 6 To 2/2/04 50481 ----- VS 525-4 2002-2004 w/Grommets VIN W 2002-2003 F150 & F150 Super Crew 2002-2004 E150, E250 2003-2004 Expedition Explorer Mountaineer 2004 F150 Heritage VIN W 50564 ----- VS 525-5 2004 VIN 6 F150 Heritage F150 Super Crew From 2/3/04 V 50367</p>	<p>TCS 525-1 1997-1998 & 2004-2006 Expedition F150,F250 Models 45869-1 ----- TCS 525-2 1999-2001 & 2002-2003 Exc. Explorer & Mountaineer 2004-2006 E150,E250 45869-2 ----- TCS 525-10 2002-2004 Explorer & Mountaineer To 2-23-04 46064 ----- TCS 525-12 2004-2006 Explorer & Mountaineer From 2-24-04 46065</p>	<p>RS 510-6 1997-2004 40620 ----- RS 510-8 1997-2004 Radial PTFE 40644</p>	<p>SS 525-2 1997-2004 72891</p>
<p>OP 510-5 1965-1968 13260</p>	<p>MS 510-5 1965-1968 90103-1</p>	<p>EMS 510-5 1965-1968 90000</p>	<p>VS 510-5 1965-1968 13264 ----- VS 510-7 1965-1969 Steel/Silicone High Perf 13264</p>	<p>TCS 510-5 1965-1968 45008</p>	<p>RS 510-5 1965-1968 30136</p>	<p>SS 508-5 1965-1968 Int. & Exh. 13364-1/72562</p>



ENGINE INFORMATION	HEAD GASKET	HEAD KIT With <u>NO</u> Valve Stem Seals	HEAD SET With Valve Stem Seals	KIT SET	SHORT BLOCK SET
--------------------	-------------	--	--------------------------------------	---------	-----------------

Ford Trucks, Mini-vans, & SUVs: V8

4.8L 292 OHV V8 Ford Engine, 16 Vlv 1957-65 VIN C 1957-1965 VIN D 1957-1965 L/D TRUCK	HG 507-7 1957-1965 7999	HK 507-7 1957-1965 7999-3	HS 507-7 1957-1965 7999-3	KS 507-7 1957-1965 7999-3	ER 507-7 1957-1965 7999-3
5.0L 302 OHV V8 Ford Engine, 16 Vlv 1968-2001 VIN F 1968-1985 VIN G 1968-1979 VIN H 1980-1985 VIN N 1985-1996 VIN P 1996-2001 VIN Y 1987-1992 L/D TRUCK	HG 510-5 1968-2001 8548-2 ----- HG 510-8 1968-2001 H.D. Type 9333-1	HK 510-5 1968-1987 8548-11 ----- HK 510-9 1987-1989 From 4-16-87 8548-12 ----- HK 510-10 1990-1996 Exc. 96 Explorer 8548-13 ----- HK 510-11 1996 Explorer 1997-2001 8548-14	HS 510-5 1968-1987 To 4-15-87 8548-11 ----- HS 510-9 1987-1989 From 4-16-87 8548-12 ----- HS 510-10 1990-1996 Exc. 96 Explorer 8548-13 ----- HS 510-11 1996 Explorer 1997-2001 8548-14	KS 510-5 1968-1987 To 4-15-87 8548-11 ----- KS 510-9 1987-1989 From 4-16-87 8548-12 ----- KS 510-10 1990-1996 Exc. 96 Explorer 8548-13 ----- KS 510-11 1996 Explorer 1997-2001 8548-14	ER 510-5 1968-1987 To 4-15-87 8548-11 ----- ER 510-9 1987-1989 From 4-16-87 8548-12 ----- ER 510-10 1990-1996 Exc. 96 Explorer 8548-13 ----- ER 510-11 1996 Explorer 1997-2001 8548-14



OIL PAN SET	INTAKE MANIFOLD SET	EXHAUST MANIFOLD SET	VALVE COVER SET	TIMING COVER SET	REAR SEAL SET	VALVE STEM SEAL SET
-------------	---------------------	----------------------	-----------------	------------------	---------------	---------------------

Ford Trucks, Mini-vans, & SUVs: V8

<p>OP 507-7 1957-1965 12701-1</p>	<p>MS 507-7 1957-1965 9361-1</p>	<p>EMS 507-5 1957-1965 9492</p>	<p>VS 507-5 1957-1959 w/Grommets 10680 ----- VS 507-7 1960-1965 w/Grommets 12949</p>	<p>TCS 507-7 1957-1965 10677-3</p>	<p>RS 507-7 1957-1965 Rope 10743 ----- RS 507-8 1957-1965 2 pc Rubber 6141</p>	<p>SS 507-5 1957-1965 10777</p>
<p>OP 510-5 1968-1994 13260 ----- OP 510-8 1988-2001 1 Pc. Silicone 34508</p>	<p>MS 510-5 1968-1976 90103-1 ----- MS 506-5 1977-1984 90361 ----- MS 506-6 1985-1996 Exc. 96 Explorer Upper & Lower Set 94951 ----- MS 506-7 1996 Explorer 1997-2001 Upper & Lower Set 95952 ----- MS 506-8 1985-1996 Exc. 96 Explorer Upper Set 93834 ----- MS 506-11 1996 Explorer 1997-2001 Upper Set 95953 ----- TB 510-2 1985-1996 Exc. 96 Explorer W/EFI 60845 ----- TB 510-4 96 Explorer & 1997-2001 TB to EGR Hsg. 61082 ----- TB 510-6 96 Explorer & 1997-2001 EGR Hsg. to Plenum 61081</p>	<p>EMS 510-5 1968-1996 90000 EXC. 96 Explorer ----- EMS 510-6 1996 Explorer 95954</p>	<p>VS 510-5 1968-1987 Cork/Rubber 13264 ----- VS 510-8 1968-2001 Cork/Rubber W/Compression Stops 50029 ----- VS 510-7 1968-2001 Steel/Silicone High Perf 13264</p>	<p>TCS 510-5 1968-1978 45008 ----- TCS 506-3 1979-2001 45449</p>	<p>RS 510-5 1968-1983 Split Seal 30136 ----- RS 510-6 1983-2001 Radial 40620 ----- RS 510-8 1983-2001 Radial PTFE 40644</p>	<p>SS 508-5 1968-1985 13364-1 72562 ----- SS 510-8 1986-1989 72562 70070 ----- SS 510-9 1990-2001 72683</p>



ENGINE INFORMATION	HEAD GASKET	HEAD KIT With <u>NO</u> Valve Stem Seals	HEAD SET With Valve Stem Seals	KIT SET	SHORT BLOCK SET
--------------------	-------------	--	--------------------------------------	---------	-----------------

Ford Trucks, Mini-vans, & SUVs: V8

<p>5.4L 330 SOHC V8 Ford Triton Engine, 16 Vlv 1997-2006</p> <p>VIN L 1997-2006 VIN W 2001-2004 VIN Z 1997-2005 (FLEX FUEL)</p>	<p>HG 525-1R 1997-2003 Right Hand 9790-2 -----</p> <p>HG 525-2L 1997-2003 Left Hand 9792-2</p>	<p>HK 525-9 1997-1998 to 7/20/97 9790-4 -----</p> <p>HK 525-14 1997-1998 From 7/21/97 & 1999 E150, E250, E350, F250 Super Duty, F350, F350 Super Duty 9790-11 -----</p> <p>HK 525-15 1999 Navigator 9790-13 -----</p> <p>HK 525-16 1999 F150, F250 & Expedition 9790-12 -----</p> <p>HK 525-17 2000-2003 9790-15</p>	<p>HS 525-9 1997-1998 to 7/20/97 9790-4 -----</p> <p>HS 525-14 1997-1998 From 7/21/97 & 1999 E150, E250, E350, F250 Super Duty, F350, F350 Super Duty 9790-11 -----</p> <p>HS 525-15 1999 Navigator 9790-13 -----</p> <p>HS 525-16 1999 F150, F250 & Expedition 9790-12 -----</p> <p>HS 525-17 2000-2003 9790-15</p>	<p>KS 525-9 1997-1998 to 7/20/97 9790-4 -----</p> <p>KS 525-14 1997-1998 From 7/21/97 & 1999 E150, E250, E350, F250 Super Duty, F350, F350 Super Duty 9790-11 -----</p> <p>KS 525-15 1999 Navigator 9790-13 -----</p> <p>KS 525-16 1999 F150, F250 & Expedition 9790-12 -----</p> <p>KS 525-17 2000-2003 9790-15</p>	<p>ER 525-9 1997-1998 to 7/20/97 9790-4 -----</p> <p>ER 525-14 1997-1998 From 7/21/97 & 1999 E150, E250, E350, F250 Super Duty, F350, F350 Super Duty 9790-11 -----</p> <p>ER 525-15 1999 Navigator 9790-13 -----</p> <p>ER 525-16 1999 F150, F250 & Expedition 9790-12 -----</p> <p>ER 525-17 2000-2003 9790-15</p>
<p>HEAD BOLTS RECOMMENDED</p>	<p>Head Bolts HB 525-5 1997-2006 72798</p>				



OIL PAN SET	INTAKE MANIFOLD SET	EXHAUST MANIFOLD SET	VALVE COVER SET	TIMING COVER SET	REAR SEAL SET	VALVE STEM SEAL SET
-------------	---------------------	----------------------	-----------------	------------------	---------------	---------------------

Ford Trucks, Mini-vans, & SUVs: V8

<p>OP 525-5 1997-2003 34307 30725</p> <p>Oil Filter Adapter 63274 1997-2003 w/Oil Cooler 70801</p>	<p>MS 525-3 1997-1998 To 7/20/97 Upper & Lower Set 95728-1 ----- MS 525-14 1997-1998 From 7/21/97 1999 E150, E250, E350, F250 Super Duty, F350, F350 Super Duty Upper & Lower Set 92188 ----- MS 525-18 1999 Navigator Upper & Lower Set 92121-2 ----- MS 525-15 1999 F150, F250, Expedition Upper & Lower Set 92188-1 ----- MS 525-16 2000-2003 Upper & Lower Set 92836-1 -----</p> <p>THROTTLE BODY SET TB 525-12 1997-2004 w/MFI Housing To Spacer & Spacer TO Manifold 61048/61050</p>	<p>EMS 525-5 1997-2004 92568</p>	<p>VS 525-3 1997-2003 50481</p>	<p>TCS 525-3 1997-1998 Vin L, M, Z 45892 ----- TCS 525-4 1999-2004 Vin L, M, Z, 3 45892-1</p>	<p>RS 510-6 1997-2004 40620 ----- RS 510-8 1997-2004 Radial PTFE 40644</p>	<p>SS 525-2 1997-2004 72891</p>
--	--	--	---	---	--	---



ENGINE INFORMATION	HEAD GASKET	HEAD KIT With <u>NO</u> Valve Stem Seals	HEAD SET With Valve Stem Seals	KIT SET	SHORT BLOCK SET
--------------------	-------------	--	--------------------------------------	---------	-----------------

Ford Trucks, Mini-vans, & SUVs: V8

<p>5.4L 330 DOHC V8 Ford Triton Engine, 32 Vlv 1999-2005</p> <p>VIN A 1999-2002 (Intech) VIN R 2002-2005 (Intech)</p> <p>HEAD BOLTS RECOMMENDED</p>	<p>HG 525-1R 1997-2003 Right Hand 9790-2 ----- HG 525-2L 1997-2003 Left Hand 9792-2</p> <p>Head Bolts HB 525-5 1997-2004 72798</p>	<p>HK 525-21 1999-2005 9790-14</p>	<p>HS 525-21 1999-2005 9790-14</p>	<p>KS 525-21 1999-2005 9790-14</p>	<p>ER 525-21 1999-2005 9790-14</p>
<p>5.4L 330 SOHC V8 CNG Ford Triton Engine, 16 Vlv 1997-2008</p> <p>VIN M 1997-2008 CNG</p> <p>HEAD BOLTS RECOMMENDED</p>	<p>HG 525-1R 1997-2008 Right Hand 9790-2 ----- HG 525-2L 1997-2008 Left Hand 9792-2</p> <p>Head Bolts HB 525-5 1997-2008 72798</p>	<p>HK 525-9 1997-1998 to 7/20/97 9790-4 ----- HK 525-14 1997-1998 From 7/21/97 & 1999 E150, E250, E350, F250 Super Duty, F350, F350 Super Duty 9790-11 ----- HK 525-16 1999 F150, F250 9790-12 ----- HK 525-17 2000-2003 VC Incl. 2004 -2005 F150 VC Incl.. 2004-2008 F250 F350 & Super Duty VC Not Incl. 9790-15 ----- HS 525-25 2004-2008 E150, E250, E350 VC Incl. 9792-7</p>	<p>HS 525-9 1997-1998 to 7/20/97 9790-4 ----- HS 525-14 1997-1998 From 7/21/97 & 1999 E150, E250, E350, F250 Super Duty, F350, F350 Super Duty 9790-11 ----- HS 525-16 1999 F150, F250 9790-12 ----- HS 525-17 2000-2003 VC Incl. 2004 -2005 F150 VC Incl.. 2004-2008 F250 F350 & Super Duty VC Not Incl. 9790-15 ----- HS 525-25 2004-2008 E150, E250, E350 VC Incl. 9792-7</p>	<p>KS 525-9 1997-1998 to 7/20/97 9790-4 ----- KS 525-14 1997-1998 From 7/21/97 & 1999 E150, E250, E350, F250 Super Duty F350, F350 Super Duty 9790PT-11 ----- KS 525-16 1999 F150, F250 9790-12 ----- KS 525-17 2000-2003 VC Incl. 2004 -2005 F150 VC Incl.. 2004-2008 F250 F350 & Super Duty VC Not Incl. 9790-15 ----- HS 525-25 2004-2008 E150, E250, E350 VC Incl. 9792-7</p>	<p>ER 525-9 1997-1998 to 7/20/97 9790-4 ----- ER 525-14 1997-1998 From 7/21/97 & 1999 E150, E250, E350, F250 Super Duty, F350, F350 Super Duty 9790-11 ----- ER 525-16 1999 F150, F250 9790-12 ----- ER 525-17 2000-2003 VC Incl. 2004 -2005 F150 VC Incl.. 2004-2008 F250 F350 & Super Duty VC Not Incl. 9790-15 ----- HS 525-25 2004-2008 E150, E250, E350 VC Incl. 9792-7</p>

OIL PAN SET	INTAKE MANIFOLD SET	EXHAUST MANIFOLD SET	VALVE COVER SET	TIMING COVER SET	REAR SEAL SET	VALVE STEM SEAL SET
-------------	---------------------	----------------------	-----------------	------------------	---------------	---------------------

Ford Trucks, Mini-vans, & SUVs: V8

<p>OP 525-5 1999-2003 34307 30725</p> <p>Oil Filter Adapter 63274 1999-2005 w/Oil Cooler 70801</p>	<p>MS 525-17 1999-2005 UPPER & LOWER SET 92902 ----- THROTTLE BODY TB 525-3 1999-2005 w/MFI 61042</p>	<p>EMS 525-6 1999-2005 92949</p>	<p>VS 525-8 1999-2004 50477</p>	<p>TCS 525-6 1993-2004 45980</p>	<p>RS 510-6 1999-2004 40620 ----- RS 510-8 1999-2004 Radial PTFE 40644</p>	<p>SS 525-4 1999-2004 72888</p>
<p>OP 525-5 1999-2003 34307 30725</p> <p>Oil Filter Adapter 63274 1997-2006 w/Oil Cooler 70801</p>	<p>MS 525-3 1997-1998 To 7/20/97 Upper & Lower Set 95728-1 ----- MS 525-14 1997-1998 From 7/21/97 1999 E150, E250, E350, F250 Super Duty, F350, F350 Super Duty Upper & Lower Set 92188 ----- MS 525-15 1999 F150, F250, Upper & Lower Set 92188-1 ----- MS 525-16 2000-2003 F Series Upper & Lower Set 92836-1 ----- MS 525-32 2004-2008 E Series Upper & Lower Set 96281</p>	<p>EMS 525-5 1999-2008 92568</p> <p>THROTTLE BODY SET TB 525-12 1997-1999 w/MFI Housing To Spacer & Spacer To Manifold 61048/61050 ----- TB 525-10 2000-2003 Housing To Spacer 61205-1 ----- TB 525-7 2000-2008 Spacer To Manifold 61103 ----- TB 525-2 2004-2008 Housing To Spacer 61050</p>	<p>VS 525-3 1997-2003 w/o Grommets 2004 F150, F250, F350 & Super Duty E150, E250, E350 To 4/20/2004 50481 ----- VS 525-5 2004 F150, F250, F350 & Super Duty E150, E250, E350 From 4/21/2004 2005-2008 w/Grommets 50603</p>	<p>TCS 525-3 1997-1998 45892 ----- TCS 525-4 1999-2008 45892-1</p>	<p>RS 510-6 1999-2008 40620 ----- RS 510-8 1999-2008 Radial PTFE 40644</p>	<p>SS 525-2 1997-2008 72891</p>



ENGINE INFORMATION	HEAD GASKET	HEAD KIT With <u>NO</u> Valve Stem Seals	HEAD SET With Valve Stem Seals	KIT SET	SHORT BLOCK SET
--------------------	-------------	--	--------------------------------------	---------	-----------------

Ford Trucks, Mini-vans, & SUVs: V8

<p>5.4L 330 SOHV Supercharged V8 Ford Engine, 16 Vlv 1999-2004</p> <p>VIN 3 1999-2004 SUPERCHARGED</p>	<p>HG 525-1R 1999-2004 Right Hand 9790-2 ----- HG 525-2L 1999-2004 Left Hand 9792-2</p>	<p>HK 525-28 1999-2001 to 12-4-00 9790-18 ----- HK 525-29 From 12-5-00 to 2004 9790-19</p>	<p>HS 525-28 1999-2001 to 12-4-00 9790-18 ----- HS 525-29 From 12-5-00 to 2004 9790-19</p>	<p>KS 525-28 1999-2001 to 12-4-00 9790-18 ----- KS 525-29 From 12-5-00 to 2004 9790-19</p>	<p>ER 525-28 1999-2001 to 12-4-00 9790-18 ----- ER 525-29 From 12-5-00 to 2004 9790-19</p>
<p>5.4L 330 OHV M/D V8 Ford Engine, 16 Vlv 1975-1977</p> <p>M/D TRUCK</p>	<p>HG 505-6 1975-1977 8045</p>	<p>HK 505-6 1975-1977 8045-5</p>	<p>HS 505-6 1975-1977 8045-5</p>	<p>KS 505-6 1975-1977 8045-2</p>	<p>ER 505-6 1975-1977 8045-2</p>
<p>5.4L 332 OHV V8 Ford Engine, 16 Vlv 1960-1963</p> <p>L/D TRUCK</p>	<p>HG 505-3 1960-1963 8554</p>	<p>HK 505-3 1960-1963 8554</p>	<p>HS 505-3 1960-1963 8554</p>	<p>KS 505-5 1960-1963 8554</p>	<p>ER 505-5 1960-1963 8554</p>
<p>5.8L 351 OHV V8 Ford Cleveland Engine, 16 Vlv 1970-74</p> <p>VIN H 1970-1974 VIN M 1970-1971 VIN Q 1971-1974 (Cobra Jet) VIN R 1971-1971 (Boss)</p>	<p>HG 508-5 1970-1974 8347-1</p>	<p>HK 508-3 1970-1974 Valley Pan N/I 8347</p>	<p>HS 508-3 1970-1974 Valley Pan N/I 8347</p>	<p>KS 508-3 1970-1974 Valley Pan N/I 8347</p>	<p>ER 508-3 1970-1974 Valley Pan N/I 8347</p>
<p>5.8L 351 OHV V8 Ford Modified Engine, 16 Vlv 1975-82</p> <p>VIN G 1980-1982 VIN H 1975-1979</p>	<p>HG 508-5 1975-1982 8347-1</p>	<p>HK 508-3 1975-1982 Valley Pan N/I 8347</p>	<p>HS 508-3 1975-1982 Valley Pan N/I 8347</p>	<p>KS 508-3 1975-1982 Valley Pan N/I 8347</p>	<p>ER 508-3 1975-1982 Valley Pan N/I 8347</p>

OIL PAN SET	INTAKE MANIFOLD SET	EXHAUST MANIFOLD SET	VALVE COVER SET	TIMING COVER SET	REAR SEAL SET	VALVE STEM SEAL SET
-------------	---------------------	----------------------	-----------------	------------------	---------------	---------------------

Ford Trucks, Mini-vans, & SUVs: V8

OP 525-5 1999-2004 34307 30725 ----- Oil Filter Adapter 63274 1999-2004 w/Oil Cooler 70801	MS 525-1999-2001 To 12-4-00 Lower Set 96368 ----- MS 525-1999-2000 Upper Set 96374 ----- MS 525-29 2001-2004 From 12-5-2000 Lower Set 96140 ----- MS 525-19 2001-2004 Upper Set 96375	EMS 525-5 1999-2004 92568 ----- THROTTLE BODY TB 525-13 1999-2004 Spacer to Man. 61200 ----- TB 525-15 1999-2004 Hsg. to Spacer 61142	VS 525-3 1999-2003 50481 ----- GROMMET SET VCG 525-5 1999-2004 71189	TCS 525-4 1999-2004 45892-1	RS 510-6 1999-2004 40620 ----- RS 510-8 1999-2004 Radial PTFE 40644	SS 525-2 1997-2004 72891
OP 505-3 1975-1977 11701	MS 505-6 1975-1977 90091	EMS 505-6 1975-1977 9945	VS 505-3 1975-1977 13049	TCS 505-6 1975-1977 6688	RS 505-4 1975-1977 2 Pc. Rubber 30138	SS 505-5 1975-1977 13401
OP 505-3 1960-1963 11701	MS 505-3 1960-1963 90145	EMS 505-2 1960-1963 9906	VS 505-3 1960-1963 13049	TCS 505-2 1960 11700-1 ----- TCS 505-3 1961-1963 13075-1	RS 505-4 1960-1963 30138	SS 505-3 1960-1963 13401
OP 508-3 1970-1974 30227	VP 508-2 1970-1974 w/2 Bbl. Carb. 96010 ----- VP 508-4 1970-1974 w/4 Bbl. Carb 96012	EMS 508-2 1970-1974 w/2 Bbl. Carb 90526 ----- EMS 508-5 1970-1974 w/4 Bbl. Carb 90332	VS 508-5 1970-1974 50068	TCS 508-3 1970-1974 45061	RS 508-5 1970-1974 2 Pc. Rubber 40042	SS 508-5 1970-1974 Int & Exh 13364-1/72562
OP 508-3 1975-1982 30227	VP 508-5 1975-1982 96020	EMS 508-2 1975-1982 90526	VS 508-5 1975-1982 50068	TCS 508-3 1975-1982 45061	RS 508-5 1975-1982 40042	SS 508-5 1975-1982 Int & Exh 13364-1/72562



ENGINE INFORMATION	HEAD GASKET	HEAD KIT With <u>NO</u> Valve Stem Seals	HEAD SET With Valve Stem Seals	KIT SET	SHORT BLOCK SET
--------------------	-------------	--	--------------------------------------	---------	-----------------

Ford Trucks, Mini-vans, & SUVs: V8

<p>5.8L 351 OHV V8 Ford Windsor Engine, 16 Vlv 1969-98</p> <p>VIN G 1980-1985 VIN H 1969-1979 & 1984-1998 VIN M 1969-1971 VIN R 1993-1998 (Lightning) VIN W 1980</p>	<p>HG 510-5 1969-98 8548-1 -----</p> <p>HG 510-8 1969-1998 H/D Style 9333-1</p>	<p>HK 506-2 1969-1974 8548-2 -----</p> <p>HK 506-5 1975-1987 Exc. E 150, E 350 Models 8548-6 -----</p> <p>HK 506-7 5/30/87 To 1998 Int & Exh For VIN R N/I 8548-9 -----</p> <p>HK 506-8 1975-1987 E 150, E 350 & Over 8500 GVW Valley Pan N/I 8541</p>	<p>HS 506-2 1969-1974 8548-2 -----</p> <p>HS 506-5 1975-1987 Exc. E 150, E 350 Models 8548-6 -----</p> <p>HS 506-7 5/30/87 To 1998 Int & Exh, VSS For VIN R N/I 8548-9 -----</p> <p>HS 506-8 1975-1987 E 150, E 350 & Over 8500 GVW Valley Pan N/I 8541</p>	<p>KS 506-2 1969-1974 8548-2 -----</p> <p>KS 506-5 1975-1987 Exc. E 150, E 350 Models 8548-6 -----</p> <p>KS 506-7 5/30/87 To 1993 Int & Exh, VSS For VIN R N/I 8548-9 -----</p> <p>KS 506-8 1975-1987 E 150, E 350 & Over 8500 GVW Valley Pan N/I 8541 -----</p> <p>KS 506-9 1994-1998 Int & Exh ,VSS For VIN R N/I</p>	<p>ER 506-2 1969-1974 8548-2 -----</p> <p>ER 506-5 1975-1987 Exc. E 150, E 350 Models 8548-6 -----</p> <p>ER 506-7 5/30/87 To 1993 Int & Exh For VIN R N/I 8548-9 -----</p> <p>ER 506-8 1975-1987 E 150, E 350 & Over 8500 GVW Valley Pan N/I 8541 -----</p> <p>ER 506-9 1994-1998 Int & Exh ,VSS For VIN R N/I</p>
<p>5.8L 352 OHV V8 Ford Engine, 16 Vlv 1957-67</p> <p>VIN D 1965-1967 VIN H 1957-1959</p>	<p>HG 505-3 1957-1959 1965-1967 8554</p>	<p>HK 505-3 1957-1959 1965-1967 8554</p>	<p>HS 505-3 1957-1959 1965-1967 8554</p>	<p>KS 505-3 1957-1959 1965-1967 8554</p>	<p>ER 505-3 1957-1959 1965-1967 8554</p>
<p>5.9L 360 OHV V8 Ford Engine, 16 Vlv 1968-77</p> <p>VIN H 1975-1976 VIN Y 1968-1977</p>	<p>HG 505-3 1968-1977 8554</p>	<p>HK 505-3 1968-1977 8554</p>	<p>HS 505-3 1968-1977 8554</p>	<p>KS 505-3 1968-1977 8554</p>	<p>ER 505-3 1968-1977 8554</p>

OIL PAN SET	INTAKE MANIFOLD SET	EXHAUST MANIFOLD SET	VALVE COVER SET	TIMING COVER SET	REAR SEAL SET	VALVE STEM SEAL SET
-------------	---------------------	----------------------	-----------------	------------------	---------------	---------------------

Ford Trucks, Mini-vans, & SUVs: V8

<p>OP 506-3 1969-1973 30214 -----</p> <p>OP 506-8 From 6-30-87 To 1993 1 Pc. Silicone 30616 -----</p> <p>OP 506-9 1994-1998 1 Pc. Silicone 34506</p>	<p>MS 506-4 1969-74 90116 -----</p> <p>MS 506-5 1975-1998 Lower Set Exc. Vin R 1993-1996 90361 -----</p> <p>VP 506-5 1975-1983 To 7-10-83 E150, E 350 Van 1983-1987 Over 8500 GVW From 7-11-83 96025 -----</p> <p>MS 506-9 1988-1998 Upper Se Vin H 1993-1996 94176 -----</p> <p>MS 506-10 1993-1996 Vin R Upper & Lower Set 95952-1 -----</p> <p>MS 506-11 1993-1996 Upper Set VIN R 95953</p>	<p>EMS 510-5 1969-1998 Exc. F150 Lighting, Vin R 90000 -----</p> <p>EMS 506-6 1993-1996 F150 Lighting Vin R 95954</p>	<p>VS 510-5 1969-1987 13264 -----</p> <p>VS 510-7 From 5-30-87 To 1998 Steel Rail/Silicone 13264 -----</p> <p>VS 510-8 1987-1998 High Temp w/Compression Stops 50029</p>	<p>TCS 510-5 1969-1978 45008 -----</p> <p>TCS 506-3 1979-1998 45449</p>	<p>RS 508-5 1969-7-10-83 2 Pc Rubber 40042 -----</p> <p>RS 511-5 7/11/83 To 5-31-87 Radial 40509 -----</p> <p>RS 511-6 From 6-1-87 To 1998 Radial 40592 -----</p> <p>RS 506-8 From 7-11-83 To 1998 Radial PTFE 40645</p>	<p>SS 510-5 1969-1975 Int & Exh. To 12-1-75 13364 -----</p> <p>SS 510-3 1975-1986 Int & Exh From 12-2-75 To 7-21-86 13807-1 -----</p> <p>SS 510-8 1986-1998 Int & Exh> 70070/70373</p>
<p>OP 505-3 1957-1959 1965-1967 11701</p>	<p>MS 505-3 1957-1959 1965-1967 90145</p>	<p>EMS 505-2 1957-1959 9906 -----</p> <p>EMS 505-3 1965-1967 9812</p>	<p>VS 505-3 1957-1959 1965-1967 13049</p>	<p>TCS 505-3 1957-1959 1965-1967 13075-1</p>	<p>RS 505-4 1957-1959 1965-1967 30138</p>	<p>SS 505-5 1957-1959 1965-1967 13401</p>
<p>OP 505-3 1967-1977 11701</p>	<p>MS 505-3 1967-1977 90145</p>	<p>EMS 505-3 1967-1977 9812 -----</p> <p>EMS 505-5 1967-1977 Heat Shield 95000</p>	<p>VS 505-3 1967-1977 13049</p>	<p>TCS 505-3 1967-1977 13075-1</p>	<p>RS 505-4 2 Pc. Rubber 30138</p>	<p>SS 505-5 1967-1977 13401</p>



ENGINE INFORMATION	HEAD GASKET	HEAD KIT With <u>NO</u> Valve Stem Seals	HEAD SET With Valve Stem Seals	KIT SET	SHORT BLOCK SET
--------------------	-------------	--	--------------------------------------	---------	-----------------

Ford Trucks, Mini-vans, & SUVs: V8

5.9L 361 OHV V8 Ford Engine, 16 Vlv 1964-66 L/D TRUCK	HG 505-3 1964-1966 8554	HK 505-3 1964-1966 8554	HS 505-3 1964-1966 8554	KS 505-3 1964-1966 8554	ER 505-3 1964-1966 8554
6.1L 370 OHV V8 Ford Engine, 16 Vlv 1979-91 M/D TRUCK	HG 512-6 1979-1991 8559-1	HK 512-6 1979-1991 8559-1	HS 512-6 1979-1991 8559-1	KS 512-6 1979-1991 8559-1	ER 512-6 1979-1991 8559-1
6.4L 389 OHV V8 Ford Engine, 16 Vlv 1973-78 M/D TRUCK	HG 505-6 1973-1978 8045	HK 505-6 1973-1978 8045	HS 505-6 1973-1978 8045	KS 505-6 1973-1978 8045	ER 505-6 1973-1978 8045
6.4L 390 OHV V8 Ford Engine, 16 Vlv 1967-76 VIN H 1967-1977 VIN M 1974-1977 VIN S 1968-1969 (GT) VIN Y 1967-1969	HG 505-3 1967-1976 8554	HK 505-3 1967-1976 8554	HS 505-3 1967-1976 8554	KS 505-3 1967-1976 8554	ER 505-3 1967-1976 8554
6.6L 400 OHV V8 Ford Engine, 16 Vlv 1972-82 VIN S 1972-1980 VIN Z 1980-1982	HG 508-5 1972-1982 8347-1	HK 508-3 1972-1982 Valley Pan N/I 8347	HS 508-3 1972-1982 Valley Pan N/I 8347	KS 508-3 1972-1982 Valley Pan N/I 8347	ER 508-3 1972-1982 Valley Pan N/I 8347
6.9L 420 OHV Diesel V8 International Engine, 16 Vlv (IDI) 1983-87 VIN 1 1983-1987	HG 533-6 1983-1987 8891-1	HK 533-6 1983-1987 Valley Pan N/I 8891	HS 533-6 1983-1987 Valley Pan N/I 8891	KS 533-6 1983-1987 Valley Pan N/I 8891	ER 533-6 1983-1987 Valley Pan N/I 8891

OIL PAN SET	INTAKE MANIFOLD SET	EXHAUST MANIFOLD SET	VALVE COVER SET	TIMING COVER SET	REAR SEAL SET	VALVE STEM SEAL SET
-------------	---------------------	----------------------	-----------------	------------------	---------------	---------------------

Ford Trucks, Mini-vans, & SUVs: V8

OP 505-3 1964-1966 11701	MS 505-3 1964-1966 90145	EMS 505-2 1964-1966 9906	VS 505-3 1964-1966 13049	TCS 505-3 1964-1966 13075-1	RS 505-4 1964-1966 2 Pc. Rubber 30138	SS 505-5 1964-1966 13401
OP 512-5 1979-3/30/89 30408 ----- OP 512-6 3/31/89-1991 34600	VP 512-5 1979-1991 96018	EMS 512-5 1979-1991 90291 ----- EMS 512-7 1979-1991 Heat Shield 90256	VS 512-5 1979-1991 50044	TCS 512-7 1979-1987 45222 ----- TCS 512-8 1988-1991 Use OP 3/31/89 -91 45880	RS 512-5 1979-1991 2 Pc. Rubber 40032	SS 512-7 1979-1989 72504 ----- SS 512-6 1990-1991 72504-1
OP 505-3 1973-1978 11701	MS 505-6 1973-1978 90091	EMS 505-6 1973-1978 9945	VS 505-3 1973-1978 13049	TCS 505-6 1973-1978 6688	RS 505-4 1973-1978 2 Pc. Rubber 30138	SS 505-5 1976-1978 13401
OP 505-3 1967-1977 11701	MS 505-3 1967-1977 90145	EMS 505-3 1967-1977 9812 ----- EMS 505-5 1967-1977 Heat Shield 95000	VS 505-3 1967-1977 13049	TCS 505-3 1967-1977 13075-1	RS 505-4 1967-1977 2 Pc. Rubber 30138	SS 505-5 1967-1977 13401
OP 508-3 1972-1982 30227	VP 508-2 1972-1974 Exc. Thermactor 96013 ----- VP 508-6 1972-1974 w/Thermactor 96017 ----- VP 508-5 1975-1982 96020	EMS 508-2 1972-1982 90526	VS 508-5 1972-1982 50068	TCS 508-3 1972-1982 45061	RS 508-5 1972-1982 40042	SS 508-5 1972-1982 Exc 1977-1980 Int & Exh 13364-1/72562 ----- SS 510-5 1977-1980 Int & Exh 13364
OP 533-8 1983-1987 34200	VP 533-8 1983-1987 96038	EMS 533-8 1983-1987 91242	VS 533-8 1983-1987 50247	TCS 533-8 1983-1987 45575	RS 533-8 1983-1987 15868-1	SS 533-8 1983-1987 Short Seal 72628 ----- SS 533-9 1983-1987 Long Seal 72628-1



ENGINE INFORMATION	HEAD GASKET	HEAD KIT With <u>NO</u> Valve Stem Seals	HEAD SET With Valve Stem Seals	KIT SET	SHORT BLOCK SET
--------------------	-------------	--	--------------------------------------	---------	-----------------

Ford Trucks, Mini-vans, & SUVs: V8

7.0L 428 OHV V8 Ford Engine, 16 Vlv 1968-69 VIN Q 1968-1969 VIN R 1968-1969 (Cobra & Super Cobra Jet)	HG 505-3 1968-1969 8554	HK 505-3 1968-1969 8554	HS 505-3 1968-1969 8554	KS 505-3 1968-1969 8554	ER 505-3 1968-1969 8554
7.0L 429 OHV V8 Ford Engine, 16 Vlv 1970-73 VIN C 1970-1971 (Cobra & Super Cobra Jet) VIN J 1970-1971 (Cobra & Super Cobra Jet) VIN N 1970-1973 VIN P 1971-1972 (Police) VIN R 1971	HG 512-5 1970-1973 8265-1	HK 512-5 1970-1973 8265-1	HS 512-5 1970-1973 8265-1	KS 512-5 1970-1973 8265-1	ER 512-5 1970-1973 8265-1
7.3L 444 OHV Diesel V8 International Engine, 16 Vlv (IDI) 1988-95 VIN M 1988-1995	HG 533-8 1968-1995 9047	HK 533-8 1968-1995 Valley Pan N/I 9047	HS 533-8 1968-1995 Valley Pan N/I 9047	KS 533-8 1968-1995 Valley Pan N/I 9047	ER 533-8 1968-1995 Valley Pan N/I 9047
7.3L 444 OHV Turbo Diesel V8 International Engine, 16 Vlv (IDI) 1992-94 VIN C 1992-1993 VIN K 1994	HG 533-8 1992-1994 9047	HK 533-8 1992-1994 Valley Pan & Turbo Mtg. N/I 9047	HS 533-8 1992-1994 Valley Pan & Turbo Mtg. N/I 9047	KS 533-8 1992-1994 Valley Pan & Turbo Mtg. N/I 9047 d	ER 533-8 1992-1994 Valley Pan & Turbo Mtg. N/I 9047
7.3L 444 E OHV Turbo Diesel V8 International Powerstroke Engine, 16 Vlv (DI) 1994-2003 VIN F 1994-2003	HG 534-5 1994-2003 9239	HK 534-5 1994-2003 9239	HS 534-5 1994-2003 9239	KS 534-5 1994-2003 9239	ER 534-5 1994-2003 9239



OIL PAN SET	INTAKE MANIFOLD SET	EXHAUST MANIFOLD SET	VALVE COVER SET	TIMING COVER SET	REAR SEAL SET	VALVE STEM SEAL SET
-------------	---------------------	----------------------	-----------------	------------------	---------------	---------------------

Ford Trucks, Mini-vans, & SUVs: V8

OP 505-3 1968-1969 11701	MS 505-3 1968-1969 90145	EMS 505-3 1968-1969 9812 ----- EMS 505-5 1968-1969 Heat Shield 95000	VS 505-3 1968-1969 13049	TCS 505-3 1968-1969 13075-1	RS 505-4 1968-1969 30138	SS 505-5 1968-1969 13401
OP 512-5 1970-1973 30408	MS 512-5 1970-1973 90110-1	EMS 512-5 1970-1973 90261 ----- EMS 512-8 1970-1973 Heat Shield 90256	VS 512-5 1970-1973 50044	TCS 512-5 1970-1973 45024	RS 512-5 1970-1973 40032	SS 510-5 1970-1973 13364
OP 533-8 1988-1995 34200	VP 533-8 1988-1995 96038	EMS 533-8 1988-1995 91242	VS 533-8 1988-1995 50247	TCS 533-8 1988-1995 45575	RS 533-8 1988-1995 Radial 15868-1	SS 533-8 1988-1995 72628-1
OP 533-8 1992-1994 34200	VP 533-8 1992-1994 96038	EMS 533-8 1992-1994 91242	VS 533-8 1992-1994 50247	TCS 533-8 1992-1994 45575	RS 533-8 1992-1994 Radial 15868-1	SS 533-8 1992-1994 72628-1
OP RTV	MS N/A	EMS 534-5 1994-2003 93489	VS 534-5 1994-1997 One Side (2 Req'd) 50483 ----- VS 534-6 1998-2003 One Side (2 Req'd) 50484	TCS 534-2 1994-1995 45016 ----- TCS 534-4 1996 To 3-31-99 45017 ----- TCS 534-5 From 4-1-99 -2003 45050	RS 534-5 1994-2003 PTFE 40436	SS 534-5 1994-2003 72893



ENGINE INFORMATION	HEAD GASKET	HEAD KIT With <u>NO</u> Valve Stem Seals	HEAD SET With Valve Stem Seals	KIT SET	SHORT BLOCK SET
--------------------	-------------	--	--------------------------------------	---------	-----------------

Ford Trucks, Mini-vans, & SUVs: V8

<p>7.5L 460 OHV V8 Ford Engine, 16 Vlv 1973-98</p> <p>VIN A 1973-1979 VIN G 1987-1998 VIN J 1973-1979 VIN L 1980-1987</p>	<p>HG 512-5 1973-1985 To 6-28-85 8265-1 -----</p> <p>HG 512-6 1985-1998 From 6-29-85 8558-1</p>	<p>HK 512-5 1973-1987 Valley Pan N/I 8265-1 -----</p> <p>HK 512-8 1973-1987 w/Valley Pan -----</p> <p>HK 512-13 1988-1989 8558-4 -----</p> <p>HK 512-15 1990-1998 8558-6/10</p>	<p>HS 512-5 1973-1985 To 6-28-85 Valley Pan N/I 8265-1 -----</p> <p>HS 512-8 1973-1985 To 6-28-85 w/Valley Pan -----</p> <p>HS 512-6 1986 From 2-21-86 INT N/I 1987 w/4 Bbl INT N/I 8558-3 -----</p> <p>HS 512-13 1987-1989 w/MFI 8558-4 -----</p> <p>HS 512-15 1990-1998</p>	<p>KS 512-5 1973-1985 To 6-28-85 Valley Pan N/I 8265-1 -----</p> <p>KS 512-8 1973-1985 To 6-28-85 w/Valley Pan -----</p> <p>KS 512-6 1986 From 2-21-86 INT N/I 1987 w/4 Bbl INT N/I 8558-3 -----</p> <p>KS 512-13 1987-1989 w/MFI 8558-4 -----</p> <p>KS 512-15 1990-1998</p>	<p>ER 512-5 1973-1985 To 6-28-85 Valley Pan N/I 8265-1 -----</p> <p>ER 512-8 1973-1985 To 6-28-85 w/ Valley Pan -----</p> <p>ER 512-6 1986 From 2-21-86 INT N/I 1987 w/4 Bbl INT N/I 8558-3 -----</p> <p>ER 512-13 1987-1989 w/MFI 8558-4 -----</p> <p>ER 512-15 1990-1998</p>
<p>7.8L 475 OHV V8 Ford Engine, 16 Vlv 1972-79 M/D & H/D</p>	<p>HG 513-5 1972-1979 7789</p>	<p>HK 513-5 1972-1979 7789-2</p>	<p>HS 513-5 1972-1979 7789-2</p>	<p>KS 513-5 1972-1979 7789-2</p>	<p>ER 513-5 1972-1979 7789-2</p>
<p>7.8L 477 OHV V8 Ford Engine, 16 Vlv 1970-81 M/D & H/D</p>	<p>HG 513-5 1970-1981 7789</p>	<p>HK 513-5 1970-1981 7789-2</p>	<p>HS 513-5 1970-1981 7789-2</p>	<p>KS 513-5 1970-1981 7789-2</p>	<p>ER 513-5 1970-1981 7789-2</p>
<p>8.8L 534 OHV V8 Ford Engine, 16 Vlv 1958-81 H/D</p>	<p>HG 513-5 1958-1981 7789</p>	<p>HK 513-5 1958-1981 7789-2</p>	<p>HS 513-5 1958-1981 7789-2</p>	<p>KS 513-5 1958-1981 7789-2</p>	<p>ER 513-5 1958-1981 7789-2</p>



OIL PAN SET	INTAKE MANIFOLD SET	EXHAUST MANIFOLD SET	VALVE COVER SET	TIMING COVER SET	REAR SEAL SET	VALVE STEM SEAL SET
-------------	---------------------	----------------------	-----------------	------------------	---------------	---------------------

Ford Trucks, Mini-vans, & SUVs: V8

<p>OP 512-5 1973-1989 To 3-30-89 30408 -----</p> <p>OP 512-6 1989-1994 From 3-31-89 1 Pc. Silicone 34600 -----</p> <p>OP 512-8 1995-1998 1 Pc. Silicone 34507</p>	<p>MS 512-5 1973-1974 To Ser. T20000 90110-1 -----</p> <p>VP 512-5 1974-1998 Exc. LPG Ser. T20001 & Up F53 96018 -----</p> <p>MS 512-10 1988-1998 Exc. F53 Upper & Lower 94175 -----</p> <p>MS 512-9 1988-1998 Upper Set 94177</p>	<p>EMS 512-5 1973-1987 4 Bbl Oval Port 90291 -----</p> <p>EMS 512-8 1973-1987 Heat Shield 4 Bbl Oval Port 90248 -----</p> <p>EMS 512-6 1987 w/MFI 1988-1989 1993-1998 Irregular Large Ports 94204 -----</p> <p>EMS 512-9 1990-1992 Irregular Small Ports 94531</p>	<p>VS 512-5 1973-1987 Cork/Rubber 50044 -----</p> <p>VS 512-8 1988-1994 & 1995-1998 Under 8500 GVW 50067 -----</p> <p>VS 512-9 1995-1998 Over 8500 GVW 50474</p>	<p>TCS 512-5 1973-1985 To 3-11-85 Original Cover 45024 -----</p> <p>TCS 512-8 1973-1985 Service Cover 1985-1998 45129</p>	<p>RS 512-5 1973-1998 2 Pc. 40032</p>	<p>SS 510-5 1973-1986 13364 -----</p> <p>SS 512-8 From 2-21-86 To 2-14-1992 Int & Exh 72687/72700 -----</p> <p>SS 512-9 From 2-15-92 To 1998 Int & Exh. 70070/72839</p>
<p>OP 513-5 1972-1979 11833</p>	<p>MS 513-5 1972-1979 Exc California 9486</p>	<p>EMS 513-5 1972-1979 9487</p>	<p>VS 513-5 1972-1979 12436</p>	<p>TCS 513-5 1972-1979 11839-1</p>	<p>RS 513-5 1972-1979 30137</p>	<p>SS 513-5 1972-1979 11836</p>
<p>OP 513-5 1970-1981 11833</p>	<p>MS 513-5 1970-1981 Exc California 9486</p>	<p>EMS 513-5 1970-1981 9487</p>	<p>VS 513-5 1970-1981 12436</p>	<p>TCS 513-5 1970-1981 11839-1</p>	<p>RS 513-5 1970-1981 30137</p>	<p>SS 513-5 1970-1981 11836</p>
<p>OP 513-5 1958-1981 11833</p>	<p>MS 513-5 1958-1981 Exc California 9486</p>	<p>EMS 513-5 1958-1981 9487</p>	<p>VS 513-5 1958-1981 12436</p>	<p>TCS 513-5 1958-1981 11839-1</p>	<p>RS 513-5 1958-1981 30137</p>	<p>SS 513-5 1958-1981 11836</p>



ENGINE INFORMATION	HEAD GASKET	HEAD KIT With <u>NO</u> Valve Stem Seals	HEAD SET With Valve Stem Seals	KIT SET	SHORT BLOCK SET
--------------------	-------------	--	--------------------------------------	---------	-----------------

Ford Trucks, Mini-vans, & SUVs: V10

<p>6.8L 415 SOHC V10 Ford Triton Engine, 20 Vlv 1997-2004</p> <p>VIN S 1997-2006</p>	<p>HG 530-2R 1997-2002 Right Side 26163 ----- HG 530-4L 1997-2002 Left Side 26162</p>	<p>HK 530-5 1997-2002 Upper & Lower Intake, Valve Cover N/I 26162</p>	<p>HS 530-5 1997-2002 Upper & Lower Intake, Valve Cover N/I 26162</p>	<p>KS 530-5 1997-2002 Upper & Lower Intake, Valve Cover N/I 26162</p>	<p>ER 530-5 1997-2002 Upper & Lower Intake, Valve Cover N/I 26162</p>
--	---	---	---	---	---



OIL PAN SET	INTAKE MANIFOLD SET	EXHAUST MANIFOLD SET	VALVE COVER SET	TIMING COVER SET	REAR SEAL SET	VALVE STEM SEAL SET
-------------	---------------------	----------------------	-----------------	------------------	---------------	---------------------

Ford Trucks, Mini-vans, & SUVs: V10

<p>OP 530-5 1997-2006 30710 -----</p> <p>Oil Filter Adapter 63274 1997-2006 w/Oil Cooler 70801</p>	<p>MS 530-1 1997-1998 E250, 350, 450 1997-1998 F250, 350, 450, 550 To 10-15-97 Upper & Lower Set 94012-1 -----</p> <p>MS 530-2 1998 F250, 350, 450, 550 From 10-16-97 To 7-20-98 Upper & Lower Set 94012-2 -----</p> <p>MS 530-4 1999 E250, 350, 450 1998-1999 F250, 350, 450, 550 From 7-21-98 Upper & Lower Set 94011-1 -----</p> <p>MS 530-5 2000 Upper & Lower Set 94015 -----</p> <p>MS 530-6 2001-2003 Upper & Lower Set 94014</p>	<p>EMS 530-5 1997-2003 94108-1</p>	<p>VS N/A</p>	<p>TCS 525-3 1997-1998 45982 -----</p> <p>TCS 525-4 1999-2006 45982-1</p>	<p>RS 510-6 1997-2006 40620 -----</p> <p>RS 510-8 1997-2006 Radial PTFE 40644</p>	<p>SS 530-5 1997-2006 72891-1</p>
--	--	--	-------------------	---	---	---



ENGINE INFORMATION	HEAD GASKET	HEAD KIT With <u>NO</u> Valve Stem Seals	HEAD SET With Valve Stem Seals	KIT SET	SHORT BLOCK SET
--------------------	-------------	--	--------------------------------------	---------	-----------------

GM Buick, Cad, Chev, Geo, Olds, Pont, & Saturn: 3 Cyl

1.0L 61 933cc SOHC L3 Suzuki G10 Engine, 6 Vlv 1985-2000 VIN M 1985 VIN 5 1985-88 VIN 6 1989-01	HG 313-2 1985-88 9435 ----- HG 313-4 1989-2000 9651	HK 313-2 1985-88 9435 ----- HK 313-4 1989-2000 9651	HS 313-2 1985-88 9435 ----- HS 313-4 1989-2000 9651	KS 313-2 1985-88 9435 ----- KS 313-4 1989-2000 9651	ER N/A
1.0L 61 933cc SOHC Turbo L3 Suzuki G10-T Engine, 6 Vlv 1987-1991 VIN 2 1987-91 TURBO MTG NOT IN KITS	HG 313-2 1987-88 9435 ----- HG 313-4 1989-91 9651	HK 313-2 1987-88 9435 ----- HK 313-4 1989-91 9651	HS 313-2 1987-88 9435 ----- HS 313-4 1989-91 9651	KS 313-2 1987-88 9435 ----- KS 313-4 1989-91 9651	ER N/A

GM Buick, Cad, Chev, Geo, Olds, Pont, & Saturn: 4 Cyl

1.3L 81 1324cc SOHC L4 Suzuki G13A Engine, 8 Vlv 1992-97 VIN 9 1992-97	HG 323-5 1992-1997 9623	HK 323-2 1992-1994 9117-1 ----- HK 323-4 1995-1997 9623-1	HS 323-2 1992-1994 9117-1 ----- HS 323-4 1995-1997 9623-1	KS 323-2 1992-1994 9117-1 ----- KS 323-4 1995-1997 9623-1	ER 323-2 1992-1994 9117-1 ----- ER 323-4 1995-1997 9623-1
1.3L 81 1324cc SOHC L4 Suzuki SW413 Engine, 16 Vlv 1998-2001 VIN 2 1998-2000	HG 323-5 1998-2001 9623	HK 323-5 1998-2001 9623-2	HS 323-5 1998-2001 9623-2	KS 323-5 1998-2001 9623-2	ER 323-5 1998-2001 9623-2

OIL PAN SET	INTAKE MANIFOLD SET	EXHAUST MANIFOLD SET	VALVE COVER SET	TIMING COVER SET	REAR SEAL SET	VALVE STEM SEAL SET
-------------	---------------------	----------------------	-----------------	------------------	---------------	---------------------

GM Buick, Cad, Chev, Geo, Olds, Pont, & Saturn: 3 Cyl

OP 313-2 1985-1995 30540 ----- OP 313-4 1996-2000 30700	MS 313-2 1985-1988 93267 ----- MS 313-4 1989-2000 94370	EMS 313-2 1985-1988 93268 ----- EMS 313-4 1989-2000 94371	VS 313-2 1985-1988 50292 ----- VS 313-4 W/Grommets 1989-2000 50333	TCS 313-2 Cam Frt Seal 1985-2000 45852 ----- TCS 313-4 Crank Frt Seal 1985-2000 45461	RS 313-2 Radial 1985-2000 40522	SS 313-2 1985-1988 72675 ----- SS 313-4 1989-2000 72710
OP 313-2 1987-1991 30540	MS 313-2 1987-1988 93267 ----- MS 313-4 1989-1991 94370	EMS 313-2 1987-1988 93268 ----- EMS 313-4 1989-1991 94371	VS 313-2 1987-1988 50292 ----- VS 313-4 W/Grommets 1989-1991 50333	TCS 313-2 Cam Frt Seal 1987-1991 45852 ----- TCS 313-4 Crank Frt Seal 1987-1991 45461	RS 313-2 Radial 1987-1991 40522	SS 313-2 1987-1988 72675 ----- SS 313-4 1989-1991 72710

GM Buick, Cad, Chev, Geo, Olds, Pont, & Saturn: 4 Cyl

OP 323-2 1992-1995 30594 ----- OP 323-4 1996-1997 30683	MS 323-2 1992-1994 94326 ----- MS 323-4 1995-1997 95837	EMS 323-2 1992-1997 94324	VS 323-2 1992-1994 w/Grommets 50323 ----- VS 323-4 1995-1997 w/Grommets 50375	TCS 313-2 1992-1997 Cam Frt. Seal 45852 ----- TCS 313-4 1992-1997 Crank Frt. Seal Use w/ OP 45461	RS 313-2 1992-1997 Radial 40522	SS 323-2 1992-1997 72675-1
OP 323-4 1998-2001 30683	MS 323-5 1998-2001 95402	EMS 323-5 1998-2001 95032	VS 323-5 1998-2001 w/Spark Plug Tube Seals 50473	TCS 313-2 1998-2001 Cam Frt. Seal 45852 ----- TCS 313-4 1998-3001 Crank Frt. Seal Use w/ OP 45461	RS 313-2 1998-2001 Radial 40522	SS 323-5 1998-2001 70360



ENGINE INFORMATION	HEAD GASKET	HEAD KIT With <u>NO</u> Valve Stem Seals	HEAD SET With Valve Stem Seals	KIT SET	SHORT BLOCK SET
--------------------	-------------	--	--------------------------------------	---------	-----------------

GM Buick, Cad, Chev, Geo, Olds, Pont, & Saturn: 4 Cyl

1.4L 85 SOHC L4 Chevrolet Engine, 8 Vlv 1976-77 VIN I 1976-77	HG 314-5 1976-1978 8504	HK 314-5 1976-1978 8504-1	HS 314-5 1976-1978 8504-1	KS 314-5 1976-1978 8504-1	ER 314-5 1976-1978 8504-1
1.5L 89.7 1471cc SOHC L4 Isuzu 4XC1 Engine GEO 1985-89 VIN K 1985 VIN 7 1985-89	HG 317-5 1985-1989 9436	HK 317-5 1985-1989 9436	HS 317-5 1985-1989 9436	KS 317-5 1985-1989 9436	ER 317-5 1985-1989 9436
1.5L 89.7 1471cc SOHC Turbo L4 Isuzu 4XC1-T Engine 1987-89 VIN 9 1987-89	HG 317-5 1987-1989 9436	HK 317-5 1987-1989 9436	HS 317-5 1987-1989 9436	KS 317-5 1987-1989 9436	ER 317-5 1987-1989 9436
1.6L 96.8 1587cc SOHC L4 Toyota 4ALC Engine, 8 Vlv NOVA, PRIZM 1985-88 VIN 4 1985-88	HG 316-5 1985-1988 9410	HK 316-5 1985 9078-1 ----- HK 316-6 1986-1988 9410-1	HS 316-5 1985 9078-1 ----- HS 316-6 1986-1988 9410-1	KS 316-5 1985 9078-1 ----- KS 316-6 1986-1988 9410-1	ER 316-5 1985 9078-1 ----- ER 316-6 1986-1988 9410-1

OIL PAN SET	INTAKE MANIFOLD SET	EXHAUST MANIFOLD SET	VALVE COVER SET	TIMING COVER SET	REAR SEAL SET	VALVE STEM SEAL SET
-------------	---------------------	----------------------	-----------------	------------------	---------------	---------------------

GM Buick, Cad, Chev, Geo, Olds, Pont, & Saturn: 4 Cyl

OP 314-5 1976-1978 30342	MS 314-5 1976-1978 90524	EMS 314-5 1976-1978 90360	VS 314-5 1976-1978 50140	TCS 314-5 1976-1978 Cam Frt. Seal 45285 ----- TCS 314-4 1976-1978 Crank Frt. Seal 45124	RS 314-5 1976-1978 40092	SS 315-5 1976-1978 70816
OP 317-5 1985-1989 30539	MS 317-5 1985-1989 93261	EMS 317-5 1985-1989 93262	VS 317-5 1985-1989 w/Grommets 50291-1	TCS 317-5 1985-1989 Cam Frt. Seal 45696 ----- TCS 317-6 1985-1989 Crank Frt Seal 45702	RS 317-5 1985-1989 Radial 40524	SS 317-5 1985-1989 72678
OP 317-5 1987-1989 30539	MS 317-5 1987-1989 93261	EMS 317-5 1987-1989 93262	VS 317-5 1987-1989 w/Grommets 50291-1	TCS 317-5 1987-1989 Cam Frt. Seal 45696 ----- TCS 317-6 1987-1989 Crank Frt Seal 45702	RS 317-5 1987-1989 Radial 40524	SS 317-5 1987-1989 72678
OP 316-5 1985-1988 30413	MS 316-5 1985-1988 90873	EMS USE MS	VS 316-5 1985 w/Semi Circular Plug & Grommets 50348 ----- VS 316-6 1986-1988 w/Semi Circular Plug & Grommets 50347	TCS 316-4 1985-1988 Cam Frt. Seal 45592 ----- TCS 316-5 1985-1988 Crank Frt. Seal 45624	RS 316-5 1985-1988 Radial 40409	SS 316-5 1985-1988 72553



ENGINE INFORMATION	HEAD GASKET	HEAD KIT With <u>NO</u> Valve Stem Seals	HEAD SET With Valve Stem Seals	KIT SET	SHORT BLOCK SET
--------------------	-------------	--	--------------------------------------	---------	-----------------

GM Buick, Cad, Chev, Geo, Olds, Pont, & Saturn: 4 Cyl

<p>1.6L 96.8 1587cc DOHC L4 Toyota 4AFE, 4AGE Engine, 16 Vlv 1988-97</p> <p>VIN 5 1988 NOVA 4AGE VIN 5 1990-92 PRIZM 4AGE VIN 6 1989-97 PRIZM 4AFE</p>	<p>HG 982-5 1988 & 1990 1992 Vin 5 Nova 9661 -----</p> <p>HG 939-5 1989-1992 Vin 6 Prizm 8188 -----</p> <p>HG 939-6 1993-1997 Vin 6 Prizm 9604 -----</p> <p>Head Bolts HB 116-5 72903</p>	<p>HK 982-5 1988 & 1990- 1992 Vin 5 Nova 9661 -----</p> <p>HK 939-5 1989-1992 Vin 6 Prizm 8188 -----</p> <p>HK 939-6 1993-1997 Vin 6 Prizm 9604</p>	<p>HS 982-5 1988 & 1990- 1992 Vin 5 Nova 9661 -----</p> <p>HS 939-5 1989-1992 Vin 6 Prizm 8188 -----</p> <p>HS 939-6 1993-1997 Vin 6 Prizm 9604</p>	<p>KS 982-5 1988 & 1990- 1992 Vin 5 Nova 9661 -----</p> <p>KS 939-5 1989-1992 Vin 6 Prizm 8188 -----</p> <p>KS 939-6 1993-1997 Vin 6 Prizm 9604</p>	<p>ER 982-5 1988 Nova & 1990-1992 Vin 5 Prizm 9661 -----</p> <p>ER 939-5 1989-1992 Vin 6 Prizm 8188 -----</p> <p>ER 939-6 1993-1997 Vin 6 Prizm 9604</p>
<p>1.6L 96.9 1588cc DOHC L4 Isuzu 4XE1W Engine, 16 Vlv 1990-91</p> <p>VIN 5 1990-91</p>	<p>HG 317-7 1990-1991 9685-1</p>	<p>HK 317-7 1990-1991 9685</p>	<p>HS 317-7 1990-1991 9685</p>	<p>KS 317-7 1990-1991 9685</p>	<p>ER 317-7 1990-1991 9685</p>
<p>1.6L 96.9 1588cc SOHC L4 Isuzu 4XE1V Engine, 12 Vlv 1990-93</p> <p>VIN 6 1990-93</p>	<p>HG 317-6 1990-1993 9684</p>	<p>HK 317-6 1990-1993 9684</p>	<p>HS 317-6 1990-1993 9684</p>	<p>KS 317-6 1990-1993 9684</p>	<p>ER 317-6 1990-1993 9684</p>
<p>1.6L 97.5 1598cc SOHC L4 Opel Engine 1988-93</p> <p>VIN 6 1988-93</p>	<p>HG 123-4 1988-1993 9553</p>	<p>HK 123-4 1988-1993 9553</p>	<p>HS 123-4 1988-1993 9553</p>	<p>KS 123-4 1988-1993 9553</p>	<p>ER 123-4 1988-1993 9553</p>

OIL PAN SET	INTAKE MANIFOLD SET	EXHAUST MANIFOLD SET	VALVE COVER SET	TIMING COVER SET	REAR SEAL SET	VALVE STEM SEAL SET
GM Buick, Cad, Chev, Geo, Olds, Pont, & Saturn: 4 Cyl						
OP 982-5 1988 Vin 5 Nova 1989-1992 Vin 5 & 6 Prizm 30510 ----- OP 939-5 1993-1997 Vin 6 Prizm 30639 -----	MS 982-5 1988 Vin 5 Nova 92148 ----- MS 939-5 1990-1992 Vin 5 Prizm 1993-1997 Vin 6 Prizm 94516 ----- MS 939-6 1989-1992 Vin 6 Prizm 94135	EMS 982-5 1988 Vin 5 Nova 1990-1992 Vin 5 Prizm 92939 ----- EMS 939-5 1989-1997 Vin 6 Prizm 94129	VS 982-5 1988 Vin 5 Nova 1990-1992 Vin 5 Prizm w/o Grommets 50268 ----- VS 939-5 1989-1992 Vin 6 Prizm w/Spark Plug Seals & Grommets 50324-1 ----- VS 939-6 1993-1997 Vin 6 Prizm w/Spark Plug Seals & Grommets 50440	TCS 316-5 1988 Vin 5 Nova 1990-1992 Vin 5 Prizm 1993-1997 Vin 6 Prizm Crank Frt Seal Set 45624	RS 316-5 1988-1997 Vin 5 & 6 Nova & Prizm Radial 40409	SS 982-5 1988 Vin 5 Nova 1990-1992 Vin 5 Prizm 1989-1992 Vin 6 Prizm 72656 ----- SS 939-5 1993-1997 Vin 6 Prizm 72810
OP 317-5 1990-1991 30539	MS 317-7 1990-1991 94504	EMS 317-7 1990-1991 94506	VS 317-7 1990-1991 50064	TCS 317-8 1990-1991 Cam Frt. Seal 45851 ----- TCS 317-7 1990-1991 Crank Frt> Seal 45853	RS 317-5 1990-1991 Radial 40524	SS 317-7 1990-1991 72722
OP 317-5 1990-1993 30539	MS 317-6 1990-1993 94501	EMS 317-6 1990-1993 94503	VS 317-6 1990-1993 50053	TCS 317-5 1990-1993 Cam Frt. Seal 45696 ----- TCS 317-7 1990-1993 Crank Frt> Seal 45853	RS 317-5 1990-1993 Radial 40524	SS 317-6 1990-1993 72721
OP 123-4 1988-1993 30590	MS 123-4 1988-1993 94021	EMS 123-4 1988-1993 94022	VS 123-4 1988-1993 50322	TCS 121-5 1988-1993 Cam Frt. Seal 45603 ----- TCS 123-4 1988-1990 Crank Frt. Seal 45831	RS 123-5 1988-1993 Radial 40535	SS 122-5 1988-1993 72698



ENGINE INFORMATION	HEAD GASKET	HEAD KIT With <u>NO</u> Valve Stem Seals	HEAD SET With Valve Stem Seals	KIT SET	SHORT BLOCK SET
--------------------	-------------	--	--------------------------------------	---------	-----------------

GM Buick, Cad, Chev, Geo, Olds, Pont, & Saturn: 4 Cyl

1.6L 98 SOHC L4 Chevrolet Engine, 8 Vlv 1976-87 VIN C 1982-87 VIN E 1976-80 VIN J 1978 VIN O 1979-80 VIN 9 1980-82	HG 314-5 1976-1987 8504	HK 314-5 1976-1987 8504-1	HS 314-5 1976-1987 8504-1	KS 314-5 1976-1987 8504-1	ER 314-5 1976-1987 8504-1
1.8L 107.5 1762cc DOHC L4 Toyota 7AFE Engine, 16 Vlv 1993-97 VIN 8 1993-97	HG 929-5 1993-1997 9955	HK 929-5 1993-1997 9955	HS 929-5 1993-1997 9955	KS 929-5 1993-1997 9955	ER 929-5 1993-1997 9955
1.8L 109.4 1794cc DOHC L4 Toyota 1ZZFE Engine, 16 Vlv 1998-2006 VIN 8 1998-2006	HG 940-5 1998-2006 26158-1	HK 940-5 1998-1999 26158 ----- HK 940-6 2000-2002 26158-1	HS 940-5 1998-1999 26158 ----- HS 940-6 2000-2002 26158-1	KS 940-5 1998-1999 26158 ----- KS 940-6 2000-2002 26158-1	ER 940-5 1998-1999 26158 ----- ER 940-6 2000-2002 26158-1
1.8L 109.5 1796cc SOHC L4 Opel Engine (Pontiac Brazilian) 1982-86 VIN O 1982-86 HEAD BOLTS REQUIRED (NOT IN KITS)	HG 121-5 1982-1986 9014 ----- Head Bolts HB 121-5 1982-1986 72728	HK 121-5 1982-1986 9188	HS 121-5 1982-1986 9188	KS 121-5 1982-1986 9188	ER 121-5 1982-1986 9188
1.8L 109.5 1796cc SOHC Turbo L4 Opel Engine 1984-86 VIN J 1984-86 HEAD BOLTS REQUIRED (NOT IN KITS)	HG 121-5 1984-1986 9014 ----- Head Bolts HB 121-5 1984-1986 72728	HK 121-8 1984-1986 9472-2	HS 121-8 1984-1986 9472-2	KS 121-8 1984-1986 9472-2	ER 121-8 1984-1986 9472-2



OIL PAN SET	INTAKE MANIFOLD SET	EXHAUST MANIFOLD SET	VALVE COVER SET	TIMING COVER SET	REAR SEAL SET	VALVE STEM SEAL SET
-------------	---------------------	----------------------	-----------------	------------------	---------------	---------------------

GM Buick, Cad, Chev, Geo, Olds, Pont, & Saturn: 4 Cyl

OP 314-5 1976-1987 30342	MS 314-5 1976-1987 90524	EMS 314-5 1976-1987 90360	VS 314-5 1976-1987 50140	TCS 314-5 1976-1987 Cam Frt. Seal 45285 ----- TCS 314-4 1976-1987 Crank Frt. Seal 45124	RS 314-5 1976-1987 Radial 40092	SS 315-5 1976-1987 70816
OP 929-5 1993-1997 30917	MS 929-5 1993-1997 95516	EMS 929-5 1993-1997 94129	VS 939-6 1993-1997 w/Spark Plug Seals & Grommets 50440 ----- Spark Plug Seals SPS 929-5 1993-1997	TCS 316-4 1993-1997 Cam Frt. Seal 45592 ----- TCS 929-6 1993-1997 Crank Frt. Seal 45955	RS 316-5 1993-1997 Radial 40409	SS 939-5 1993-1997 72810
OP 940-5 1998-2006 30705	MS 940-5 1998-2002 93856 ----- MS 940-6 2003-2006 93942	EMS 940-5 1998-2006 93909	VS 940-5 1998-1999 w/Grommets 50544 ----- VS 940-6 2000-2006 w/Grommets 50542	TCS 940-5 1998-2006 45054	RS 940-5 1998-2006 Radial 40661	SS 940-5 1998-2002 72878-1 ----- SS 940-6 2003-2006 72878-2
OP 121-5 1982-1986 30474	MS 121-5 1982-1986 92074	EMS 121-5 1982-1986 92081	VS 121-5 1982-1986 50243	TCS 121-5 1982-1986 Cam Frt. Seal 45603 ----- TCS 121-6 1982-1986 Crank Frt. Seal 45604	RS 121-5 1982-1986 Radial 40437	SS 121-5 1982-1986 72619
OP 121-5 1984-1986 30474	MS 121-5 1984-1986 92074	EMS 121-8 1984-1986 93653	VS 121-5 1984-1986 50243	TCS 121-5 1984-1986 Cam Frt. Seal 45603 ----- TCS 121-6 1984-1986 Crank Frt. Seal 45604	RS 121-5 1984-1986 Radial 40437	SS 121-5 1984-1986 72619



ENGINE INFORMATION	HEAD GASKET	HEAD KIT With <u>NO</u> Valve Stem Seals	HEAD SET With Valve Stem Seals	KIT SET	SHORT BLOCK SET
--------------------	-------------	--	--------------------------------------	---------	-----------------

GM Buick, Cad, Chev, Geo, Olds, Pont, & Saturn: 4 Cyl

1.8L 110.3 1808cc DOHC L4 Isuzu 4XF1 Engine, 16 Vlv 1992-93 VIN 8 1992-93	HG 125-5 1992-1993 9156	HK 125-5 1992-1993 9156	HS 125-5 1992-1993 9156	KS 125-5 1992-1993 9156	ER 125-5 1992-1993 9156
1.8L 110.8 1877cc SOHC Diesel L4 Isuzu 4FB1 Engine Chevette 1981-86 VIN D 1981-86	HG 947-5 1981-1986 8896	HK 947-5 1981-1986 8896	HS 947-5 1981-1986 8896	KS 947-5 1981-1986 8896	ER 947-5 1981-1986 8896
1.8L 112 OHV L4 Chevrolet Engine 1982 VIN G 1982	HG 315-5 1982 9407	HK 315-5 1982 9407	HS 315-5 1982 9407	KS 315-5 1982 8851-1	ER 315-5 1982 9407
1.9L 116 DOHC L4 Saturn Engine, 16 Vlv 1991-2002 VIN 7 1991-2002 HEAD BOLTS REQUIRED (NOT IN KITS)	HG 119-2 1991-2002 9968 ----- Head Bolts HB 119-5 72903	HK 119-2 1991-1993 & 1994-1995 w/Aluminum Valve Cover VS N/I 9968 ----- HK 119-4 1991-1993 & 1994-1995 w/Aluminum Valve Cover 9968-1 ----- HK 119-5 1994-1995 w/Plastic VC &1996-1998 9968-2 ----- HK 119-6 1999 VC N/I 9968-3 ----- HK 119-7 2000-2002 VC N/I 9968-4	HS 119-2 1991-1993 & 1994-1995 w/Aluminum Valve Cover VS N/I 9968 ----- HS 119-4 1991-1993 & 1994-1995 w/Aluminum Valve Cover 9968-1 ----- HS 119-5 1994-1995 w/Plastic VC &1996-1998 9968-2 ----- HS 119-6 1999 VC N/I 9968-3 ----- HS 119-7 2000-2002 VC N/I 9968-4	KS 119-2 1991-1993 & 1994-1995 w/Aluminum Valve Cover VS N/I 9968 ----- KS 119-4 1991-1993 & 1994-1995 w/Aluminum Valve Cover 9968-1 ----- KS 119-5 1994-1995 w/Plastic VC &1996-1998 9968-2 ----- KS 119-6 1999 VC N/I 9968-3 ----- KS 119-7 2000-2002 VC N/I 9968-4	ER 119-2 1991-1993 & 1994-1995 w/Aluminum Valve Cover VS N/I 9968 ----- ER 119-4 1991-1993 & 1994-1995 w/Aluminum Valve Cover 9968-1 ----- ER 119-5 1994-1995 w/Plastic VC &1996-1998 9968-2 ----- ER 119-6 1999 VC N/I 9968-3 ----- ER 119-7 2000-2002 VC N/I 9968-4

OIL PAN SET	INTAKE MANIFOLD SET	EXHAUST MANIFOLD SET	VALVE COVER SET	TIMING COVER SET	REAR SEAL SET	VALVE STEM SEAL SET
-------------	---------------------	----------------------	-----------------	------------------	---------------	---------------------

GM Buick, Cad, Chev, Geo, Olds, Pont, & Saturn: 4 Cyl

OP 125-5 1992-1993 30682	MS 125-5 1992-1993 Upper & Lower 94270 ----- MS 125-6 1992-1993 Upper Set 95836	EMS 317-7 1992-1993 94506	VS 317-7 1992-1993 50064	TCS 121-5 1992-1993 Cam Frt. Seal 45603 ----- TCS 121-6 1992-1993 Crank Frt. Seal 45604	RS 317-5 1992-1993 Radial 40524	SS 317-7 1992-1993 72722
OP 947-5 1981-1986 30481	MS 947-5 1981-1986	EMS 947-5 1981-1986	VS 947-5 1981-1986 50355	TCS 947-5 1981-1986	RS 947-5 1981-1986 Radial 40449-1	SS 947-5 1981-1986 27149
OP 315-5 1982 30433	MS 315-5 1982 91390	EMS 315-5 1982 91457	VS 315-5 1982 50222	TCS 315-5 1982 45536	RS 315-5 1982 Radial 40465 ----- RS 315-3 1982 2 Piece 40422	SS 315-5 1982 70816
OP USE RTV	MS 119-2 1991-1999 95630 ----- MS 119-4 2000-2003 94191	EMS 119-2 1991-1998 95632 ----- EMS 119-4 1999-2002 96118	VS 119-2 1991-1993 & 1994-1995 w/Aluminum Valve Cover RTV w/Grommets 50453 ----- VS 119-4 1991-1993 & 1994-1995 w/Aluminum Valve Cover Molded VC w/Grommets 50451 ----- VS 119-5 1994-1995 w/Plastic VC & 1996-1998 w/Grommets 50454 ----- VS 119-6 1999-2002 w/Grommets 50549	TCS 119-4 1991-2002 Crank Frt. Seal Set 45958	RS 315-6 1991-2002 11mm Radial 40464	SS 119-5 1991-1998 72867X2 ----- SS 116-4 1999-2002 71051



ENGINE INFORMATION	HEAD GASKET	HEAD KIT With <u>NO</u> Valve Stem Seals	HEAD SET With Valve Stem Seals	KIT SET	SHORT BLOCK SET
--------------------	-------------	--	--------------------------------------	---------	-----------------

GM Buick, Cad, Chev, Geo, Olds, Pont, & Saturn: 4 Cyl

<p>1.9L 116 SOHC L4 Saturn Engine, 8 Vlv 1991-2002</p> <p>VIN 8 1995-2002 VIN 9 1991-1994</p> <p>HEAD BOLTS REQUIRED (NOT IN KITS)</p>	<p>HG 116-5 1991-2002 9971 -----</p> <p>Head Bolts HB 116-5 72902</p>	<p>HS 116-2 1991-1994 9971 -----</p> <p>HK 116-4 1995-1999 9971-1 -----</p> <p>HK 116-5 2000-2002 9971-2</p>	<p>HS 116-2 1991-1994 9971 -----</p> <p>HS 116-4 1995-1999 9971-1 -----</p> <p>HS 116-5 2000-2002 9971-2</p>	<p>KS 116-2 1991-1994 9971 -----</p> <p>KS 116-4 1995-1999 9971-1 -----</p> <p>KS 116-5 2000-2002 9971-2</p>	<p>ER 116-2 1991-1994 9971 -----</p> <p>ER 116-4 1995-1999 9971-1 -----</p> <p>ER 116-5 2000-2002 9971-2</p>
<p>2.0L 121 OHV L4 Chevrolet Engine, 8 Vlv 1983-89</p> <p>VIN B 1983-84 VIN P 1983-86 VIN 1 1987-89</p>	<p>HG 315-5 1983-1986 9407 -----</p> <p>HG 315-7 1987-1989 9469 -----</p> <p>Head Bolts HG 315-6 1983-1986 72162 -----</p> <p>HG 315-7 1987-1989 72158</p>	<p>HK 315-5 1983-1986 9407 -----</p> <p>HK 315-7 1987-1989 9469</p>	<p>HS 315-5 1983-1986 9407 -----</p> <p>HS 315-7 1987-1989 9469</p>	<p>KS 315-5 1983-1986 8851-1/9407 -----</p> <p>KS 315-7 1987-1989 9469</p>	<p>ER 315-5 1983-1986 9407 -----</p> <p>ER 315-7 1987-1989 9469</p>
<p>2.0L 122 1998cc SOHC L4 Opel Engine 1987-94</p> <p>VIN H 1992-94 VIN K 1987-91</p> <p>HEAD BOLT REPLACEMENT RE- QUIRED</p>	<p>HG 121-5 1987-1994 9014 -----</p> <p>Head Bolts HG 121-5 72728</p>	<p>HK 121-5 1987-1994 9188-1</p>	<p>HS 121-6 1987-1994 9188-1</p>	<p>KS 121-6 1987-1994 9188-1</p>	<p>ER 121-6 1987-1994 9188-1</p>



OIL PAN SET	INTAKE MANIFOLD SET	EXHAUST MANIFOLD SET	VALVE COVER SET	TIMING COVER SET	REAR SEAL SET	VALVE STEM SEAL SET
-------------	---------------------	----------------------	-----------------	------------------	---------------	---------------------

GM Buick, Cad, Chev, Geo, Olds, Pont, & Saturn: 4 Cyl

<p>OP USE RTV</p>	<p>MS 116-2 1991-1994 95629 ----- MS 116-4 1995-2002 94286</p>	<p>EMS 116-2 1991-1999 95631 ----- EMS 116-4 2000-2002 96117</p>	<p>VS 116-5 1991-2002 RTV w/Grommets 50447</p>	<p>TCS 119-4 1991-2002 Crank Frt. Seal Set 45958</p>	<p>RS 315-6 1991-2002 11 mm Radial 40464</p>	<p>SS 119-5 1991-2002 72867X2</p>
<p>OP 315-5 1983-1986 30433 ----- OP 315-6 1987-1989 34300</p>	<p>MS 315-5 1983-1986 91390 ----- MS 315-6 1987-1989 93811</p>	<p>EMS 315-5 1983-1986 91457 ----- EMS 315-6 1987-1989 93812</p>	<p>VS 315-5 1983-1986 50222 ----- VS 315-6 1987-1989 50313</p>	<p>TCS 315-5 1983-1986 45536 ----- TCS 315-6 1987-1989 45793</p>	<p>RS 315-3 1983-1984 2 Piece 40422 ----- RS 315-5 1983-1984 Radial 5.5mm 40465 ----- RS 315-6 1984-1989 Radial 11.0mm 40464 ----- RS 315-8 1984-1989 Radial 11.0 mm PTFE 40625</p>	<p>SS 315-5 1983-1989 70816</p>
<p>OP 121-6 1987-1994 30574</p>	<p>MS 122-5 1987-1994 93625</p>	<p>EMS 121-5 1987-1994 92081</p>	<p>VS 121-5 1987-1994 50243</p>	<p>TCS 121-5 1987-1994 Cam Frt. Seal 45603 ----- TCS 121-6 1997-1994 Crank Frt. Seal 45604</p>	<p>RS 122-5 1987-1994 Radial 40555</p>	<p>SS 122-5 1987-1994 72698</p>



ENGINE INFORMATION	HEAD GASKET	HEAD KIT With <u>NO</u> Valve Stem Seals	HEAD SET With Valve Stem Seals	KIT SET	SHORT BLOCK SET
--------------------	-------------	--	--------------------------------------	---------	-----------------

GM Buick, Cad, Chev, Geo, Olds, Pont, & Saturn: 4 Cyl

<p>2.0L 122 1998cc SOHC Turbo L4 Opel Engine 1987-90</p> <p>VIN M 1987-90</p>	<p>HG 121-5 1987-1990 9014 ----- Head Bolts HG 121-5 72728</p>	<p>HK 122-7 1987-1990 9472-1</p>	<p>HS 122-7 1987-1990 9472-1</p>	<p>KS 122-7 1987-1990 9472-1</p>	<p>ER 122-7 1987-1990 9472-1</p>
<p>2.2L 134 2189cc OHV L4 Chevrolet Engine 1990-2002</p> <p>VIN G 1990-91 VIN 4 1992-2002</p> <p>HEAD BOLT REPLACEMENT RE- QUIRED</p>	<p>HG 315-6 1990-1997 9469 4023 ----- HG 315-8 1998-2003 9170-1 ----- Head Bolts HB 315-2 1990-1992 72164 ----- HB 315-4 1993-1994 74016 ----- HB 315-5 1995-1997 72172 ----- HB 315-8 1998-2002 72170</p>	<p>HK 315-7 1990-1991 9469 ----- HK 315-9 1992-1997 9469-2 ----- HK 315-11 1998-2002 9170-1</p>	<p>HS 315-7 1990-1991 9469 ----- HS 315-8 1992-1993 w/8mm Valve Stem Dia. 9469-1 ----- HS 315-9 1993-1997 w/7mm Valve Stem Dia. 9469-2 ----- HS 315-11 1998-2002 9170-1</p>	<p>KS 315-7 1990-1991 9469 ----- KS 315-8 1992-1993 w/8mm Valve Stem Dia. 9469-1 ----- KS 315-9 1993-1997 w/7mm Valve Stem Dia. 9469-2 ----- KS 315-11 1998-2002 9170-1</p>	<p>ER 315-7 1990-1991 9469 ----- ER 315-8 1992-1993 w/8mm Valve Stem Dia. 9469-1 ----- ER 315-9 1993-1997 w/7mm Valve Stem Dia. 9469-2 ----- ER 315-11 1998-2002 9170-1</p>



OIL PAN SET	INTAKE MANIFOLD SET	EXHAUST MANIFOLD SET	VALVE COVER SET	TIMING COVER SET	REAR SEAL SET	VALVE STEM SEAL SET
-------------	---------------------	----------------------	-----------------	------------------	---------------	---------------------

GM Buick, Cad, Chev, Geo, Olds, Pont, & Saturn: 4 Cyl

<p>OP 121-6 1987-1990 30574</p>	<p>MS 122-5 1987-1990 93625</p>	<p>EMS 121-8 1987-1990 93653</p>	<p>VS 121-5 1987-1990 50243</p>	<p>TCS 121-5 1987-1990 Cam Frt. Seal 45603 ----- TCS 121-6 1997-1990 Crank Frt. Seal 45604</p>	<p>RS 122-5 1987-1990 Radial 40555</p>	<p>SS 122-5 1987-1990 72698</p>
<p>OP 315-6 1990-2002 34300</p>	<p>MS 315-6 1991-1991 1st Design Intake 93811 ----- MS 315-7 1992-1997 95393 ----- MS 315-8 1998-2002 90543</p>	<p>EMS 315-6 1991-1997 93812 ----- EMS 315-8 1998-2002 90540</p>	<p>VS 315-6 1990-1997 50313 ----- VS 315-8 1998-2002 50485</p>	<p>TCS 315-6 1991-2002 45793</p>	<p>RS 315-6 1990-2002 11 mm RADIAL 40464</p>	<p>SS 083-4 1990-1992 1993 w/8mm Stem Dia 70816 ----- SS 314-6 1993 w/7mm Stem Dia 1994-1997 72852 ----- SS 315-6 1998-2002 70809</p>



ENGINE INFORMATION	HEAD GASKET	HEAD KIT With <u>NO</u> Valve Stem Seals	HEAD SET With Valve Stem Seals	KIT SET	SHORT BLOCK SET
--------------------	-------------	--	--------------------------------------	---------	-----------------

GM Buick, Cad, Chev, Geo, Olds, Pont, & Saturn: 4 Cyl

<p>2.2L 134 2198cc DOHC L4 Opel Engine, 16 Vlv 2000-2008</p> <p>VIN F 2000-2008 ECOTEC VIN 2 2002-2003 VIN 6 2003-2008 ECOTEC FLEX FUEL</p> <p>CAVILER, SATURN L, LS, LW, ION GRAND-AM</p> <p>HEAD BOLT REPLACEMENT RE- QUIRED</p>	<p>HG 134-2</p>	<p>HK 134-2 2000 Saturn 2001-2003 Saturn w/AT exc California 26223 ----- HK 134-4 2001-2003 w/MT California w/AT 26223-4 ----- HK 134-6 2002-2006 Exc Saturn 2004 Saturn L, LS, LW 26223-1</p>	<p>HS 134-2 2000 Saturn 2001-2003 Saturn w/AT exc California 26223 ----- HS 134-4 2001-2003 w/MT California w/AT 26223-4 ----- HS 134-6 2002-2006 Exc Saturn 2004 Saturn L, LS, LW 26223-1</p>	<p>KS 134-2 2000 Saturn 2001-2003 Saturn w/AT exc California 26223 ----- KS 134-4 2001-2003 w/MT California w/AT 26223-4 ----- KS 134-6 2002-2006 Exc Saturn 2004 Saturn L, LS, LW 26223-1</p>	<p>ER 134-2 2000 Saturn 2001-2003 Saturn w/AT exc California 26223 ----- ER 134-4 2001-2003 w/ MT California w/AT 26223-4 ----- ER 134-6 2002-2006 Exc Saturn 2004 Saturn L, LS, LW 26223-1</p>
<p>2.3L 138 DOHC L4 Oldsmobile Engine, 16 Vlv 1987-95</p> <p>VIN A 1989-94 (Quad 4 H.O.) VIN D 1987-95 (Quad 4)</p> <p>HEAD BOLT REPLACEMENT RE- QUIRED</p>	<p>HG 138-5 1987-1995 9515 ----- Head Bolts HB 138-5 1987-1995 72727</p>	<p>HK 138-5 1987-1991 1 st. Design TCS 20 Hole 9515 ----- HK 138-6 1992-1994 2nd Design TCS 21 Hole 9515-2 ----- HK 138-8 1995 2nd Design TCS 21 Hole 9515-3</p>	<p>HS 138-5 1987-1991 1 st. Design TCS 20 Hole 9515 ----- HS 138-6 1992-1994 2nd Design TCS 21 Hole 9515-2 ----- HS 138-8 1995 2nd Design TCS 21 Hole 9515-3</p>	<p>KS 138-5 1987-1991 1 st. Design TCS 20 Hole 9515 ----- KS 138-6 1992-1994 2nd Design TCS 21 Hole 9515-2 ----- KS 138-8 1995 2nd Design TCS 21 Hole 9515-3</p>	<p>ER 138-5 1987-1991 1 st. Design TCS 20 Hole 9515 ----- ER 138-6 1992-1994 2nd Design TCS 21 Hole 9515-2 ----- ER 138-8 1995 2nd Design TCS 21 Hole 9515-3</p>
<p>2.3L 138 SOHC L4 Oldsmobile Engine, 8 Vlv 1992-94</p> <p>VIN 3 1992-94 (Quad OHC) HEAD BOLT REPLACEMENT RE- QUIRED</p>	<p>HG 138-5 1992-1994 9515 ----- Head Bolts HB 138-5 1992-1994 72727</p>	<p>HK 138-5 1992-1994 9515-1</p>	<p>HS 138-5 1992-1994 9515-1</p>	<p>KS 138-5 1992-1994 9515-1</p>	<p>ER 138-5 1992-1994 9515-1</p>

OIL PAN SET	INTAKE MANIFOLD SET	EXHAUST MANIFOLD SET	VALVE COVER SET	TIMING COVER SET	REAR SEAL SET	VALVE STEM SEAL SET
-------------	---------------------	----------------------	-----------------	------------------	---------------	---------------------

GM Buick, Cad, Chev, Geo, Olds, Pont, & Saturn: 4 Cyl

<p>OP USE RTV</p>	<p>MS 134-2 2002-2008 All Exc Saturn 2003-2007 Saturn ION 2004 Saturn L, LS, LW 96351 ----- MS 134-4 2000-2003 Saturn L, LS, LW 96340</p> <p>THROTTLE BODY TB 134-2 2000-2004 Saturn L, LS, LW 61021 ----- TB 134-4 2002-2007 Saturn Ion 2002-2008 Exc Saturn w/MFI 61309</p>	<p>EMS 134-2 2000 Saturn L, LS, LW 2001-2003 Saturn L, LS, LW w/AT Exc. Calif. 2004 Saturn L, LS, LW 2003-2006 Saturn Ion 2007 Saturn Ion Exc. California 2002-2006 Exc Saturn 96377 ----- EMS 134-4 2001-2003 Saturn L, LS, LW With M/T California w/A/T 2007 Saturn Ion Calif. 96376</p>	<p>VS 134-2 2000-2006 w/Grommets & Spark Plug Tubes 50596</p>	<p>TCS 134-5 2000-2006 46041</p>	<p>RS 134-5 2000-2007 40671</p>	<p>SS 134-5 2000-2008 71198</p>
<p>OP 138-5 1994-1997 30597 ----- OP 138-6 1995 30678</p>	<p>MS 138-5 1987-1995 90573</p>	<p>EMS 138-5 1987-1994 90559 ----- EMS 138-6 1995 91130</p>	<p>VS 138-5 1987-1994 1 st. Design Int. & Exh. Sides 50325 ----- VS 138-6 1991-1995 2nd Design Intake Side 50444 ----- VS 138-7 1991-1995 2nd Design Exhaust Side 50445</p>	<p>TCS 138-5 1987-1995 1 st. Design 20 Bolt .70 mm 45843 ----- TCS 138-6 2nd Design 21 Bolt 3.40 mm 45954</p>	<p>RS 138-5 1987-1995 Radial 40591</p>	<p>SS 138-5 1987-1995 70287</p>
<p>OP 138-5 1992-1994 30597</p>	<p>MS 138-5 1992-1994 90573</p>	<p>EMS 138-5 1992-1994 90559</p>	<p>VS 138-4 1992-1994 1 st. Design 50452 ----- VS 138-6 1991-1995 2nd Design 50444</p>	<p>TCS 138-8 1992-1994 45960</p>	<p>RS 138-5 1992-1994 Radial 40591</p>	<p>SS 138-8 1992-1994 72862</p>



ENGINE INFORMATION	HEAD GASKET	HEAD KIT With <u>NO</u> Valve Stem Seals	HEAD SET With Valve Stem Seals	KIT SET	SHORT BLOCK SET
--------------------	-------------	--	--------------------------------------	---------	-----------------

GM Buick, Cad, Chev, Geo, Olds, Pont, & Saturn: 4 Cyl

2.4L 146 DOHC L4 Oldsmobile Engine, 16 Vlv 1996-2002 VIN T 1996-2002 (Twin Cam)	HG 138-5 1996-1998 & 1999 w/EGR 9115 ----- HG 146-4 1999 Exc. EGR 2000-2002 9059 ----- Head Bolts HB 146-5 1996-2002 72165	HK 138-5 1996-1998 & 1999 w/EGR 9115 ----- HK 146-4 1999 Exc. EGR 2000-2002 9059	HS 138-5 1996-1998 & 1999 w/EGR 9115 ----- HS 146-4 1999 Exc. EGR 2000-2002 9059	KS 138-5 1996-1998 & 1999 w/EGR 9115 ----- KS 146-4 1999 Exc. EGR 2000-2002 9059	ER 138-5 1996-1998 & 1999 w/EGR 9115 ----- ER 146-4 1999 Exc. EGR 2000-2002 9059
2.5L 151 OHV L4 Pontiac Engine, 8 Vlv Exc. Crossflow 1977-79	HG 311-5 1977-1979 8530-1	HK 311-5 1977-1979 8530	HS 311-5 1977-1979 8530	KS 311-5 1977-1979 8530	ER 311-5 1977-1979 8530



OIL PAN SET	INTAKE MANIFOLD SET	EXHAUST MANIFOLD SET	VALVE COVER SET	TIMING COVER SET	REAR SEAL SET	VALVE STEM SEAL SET
-------------	---------------------	----------------------	-----------------	------------------	---------------	---------------------

GM Buick, Cad, Chev, Geo, Olds, Pont, & Saturn: 4 Cyl

OP 138-6 1996-2002 30678	MS 146-5 1996-2002 95839	EMS 146-2 1996-1998 & 1999 w/EGR 90278 ----- EMS 146-4 1999 Exc. EGR 2000-2002 90284	VS 146-2 1996-2002 Int Cam Cover 50490 ----- VS 138-7 1996-2002 Exh. Cam Cover 50445	TCS 146-5 1996-2002 45972	RS 138-5 1996-2002 Radial 40591	SS 146-5 1996-2002 72807-1
OP 311-5 1977-1979 30139-1	MS 311-5 1977-1979 90376	USE MS	VS 311-5 1977-1979 50152	TCS 302-3 1977-1979 13198	RS 303-5 1977-1979 2 Pc. Silicone 40013	SS 312-5 1977-1979 O-Ring 5112



ENGINE INFORMATION	HEAD GASKET	HEAD KIT With <u>NO</u> Valve Stem Seals	HEAD SET With Valve Stem Seals	KIT SET	SHORT BLOCK SET
--------------------	-------------	--	--------------------------------------	---------	-----------------

GM Buick, Cad, Chev, Geo, Olds, Pont, & Saturn: 4 Cyl

2.5L 151 OHV L4 Pontiac Engine, 8 Vlv Crossflow 1979-92 VIN F 1982-83 VIN R 1980-82 VIN S 1983 VIN U 1985-91 VIN V 1979-80 VIN 1 1978-79 VIN 2 1982-86 VIN 5 1979-83 VIN 9 1978-79	HG 312-6 1979-1984 Crossflow Vin U 1985-1986 Vin R,2 1987-1993 Vin R 9405-1 ----- HG 312-8 Crossflow 1985-1991 Vin U 9406 ----- Head Bolts HG 312-5 1985-1991 Vin U 72858 ----- HB 312-6 1985-1991 Vin R, 2 72733	HK 312-5 1979-1983 Crossflow 8686-1 ----- HK 312-6 1984-1986 Vin R, 2 9405 ----- HK 312-7 1987-1992 Vin R 9405-3-4-5 ----- HK 312-8 1984-1986 9406 ----- HK 312-10 1987-1991 Vin U 9406-1-2-3	HS 312-5 1979-1983 Crossflow 8686-1 ----- HS 312-6 1984-1986 Vin R, 2 9405 ----- HS 312-7 1987-1992 Vin R 9405-3-4-5 ----- HS 312-8 1984-1986 9406 ----- HS 312-10 1987-1991 Vin U 9406-1-2-3	KS 312-5 1979-1983 Crossflow 8686-1 ----- KS 312-6 1984-1986 Vin R, 2 9405 ----- KS 312-7 1987-1992 Vin R 9405-3-4-5 ----- KS 312-8 1984-1986 9406 ----- KS 312-10 1987-1991 Vin U 9406-1-2-3	ER 312-5 1979-1983 Crossflow 8686-1 ----- ER 312-6 1984-1986 Vin R, 2 9405 ----- ER 312-7 1987-1992 Vin R 9405-3-4-5 ----- ER 312-8 1984-1986 9406 ----- ER 312-10 1987-1991 Vin U 9406-1-2-3
2.5L 153 OHV L4 Chevrolet Engine, 8 Vlv 1962-70	HG 311-5 1962-1970 8530-1	HK 300-5 1962-1970 8530-1	HS 300-5 1962-1970 8530-1	KS 300-5 1962-1970 8530-1	ER 300-5 1962-1970 8530-1



OIL PAN SET	INTAKE MANIFOLD SET	EXHAUST MANIFOLD SET	VALVE COVER SET	TIMING COVER SET	REAR SEAL SET	VALVE STEM SEAL SET
-------------	---------------------	----------------------	-----------------	------------------	---------------	---------------------

GM Buick, Cad, Chev, Geo, Olds, Pont, & Saturn: 4 Cyl

<p>OP 312-5 1979-1984 Crossflow 1985-1987 Vin R, 2 30409 -----</p> <p>OP 312-6 1985-1986 Vin U 1987 Vin U w/Auto Trans 34301</p>	<p>MS 312-5 1979-1986 Crossflow 90563 -----</p> <p>MS 312-6 1987-1988 Vin U 1987-1989 Vin R 93688 -----</p> <p>MS 312-8 1989-1991 Vin U 1990-1992 Vin R 94278</p>	<p>EMS 312-5 1979-1986 Crossflow 90564 -----</p> <p>EMS 312-6 1987-1992 Vin R, U 93689</p>	<p>VS 312-5 1979-1987 50179 -----</p> <p>VS 312-6 1988-1992 50329 -----</p> <p>Push Rod Cover</p> <p>PS 312-5 1979-1984 50153 -----</p> <p>PS 312-6 1985-1992 50276</p>	<p>TCS 302-3 1979-1982 13198 -----</p> <p>TCS 312-6 1983-1992 13198-2</p>	<p>RS 312-5 1979-1992 Radial 40578</p>	<p>SS 312-5 1979-1980 5112 O-Ring -----</p> <p>SS 312-6 1981-1986 72531 -----</p> <p>SS 312-8 1987-1992 72684</p>
<p>OP 311-5 1962-1970 30139-1</p>	<p>MS 300-5 1962-1970 9772</p>	<p>USE MS</p>	<p>VS 300-5 1962-1970 13197 -----</p> <p>Push Rod Cover</p> <p>PS 312-5 1962-1970 50153</p>	<p>TCS 302-3 1962-1970 13398</p>	<p>RS 302-1 1962-1967 13241 -----</p> <p>RS 303-5 1968-1970 2 Pc. Silicone 40013</p>	<p>SS 312-5 1962-1970 5112 O-Ring</p>



ENGINE INFORMATION	HEAD GASKET	HEAD KIT With <u>NO</u> Valve Stem Seals	HEAD SET With Valve Stem Seals	KIT SET	SHORT BLOCK SET
--------------------	-------------	--	--------------------------------------	---------	-----------------

GM Buick, Cad, Chev, Geo, Olds, Pont, & Saturn: 6 Cyl

<p>2.8L 173 2835cc OHV V6 Chevrolet Engine, 12 Vlv 1980-89</p> <p>VIN L 1983-1984 VIN S 1985-1989 VIN W 1985-1989 VIN X 1981-1986 VIN Z 1981-1984 VIN 1 1982-1984 VIN 7 1980 VIN 9 1985-1988</p>	<p>HG 305-5 1980-1986 & 1987-1989 VIN S & 9 8699-2 ----- HG 305-7 1987-1989 VIN W 9471</p>	<p>HK 305-5 1980-1984 & 1985-1986 VIN X 2 Bbl. 8699-4 ----- HK 305-6 1985-1986 VIN S, W w/F.I. & 1987-1989 VIN S 8699-6 ----- HK 305-7 1987-1989 VIN W 9471 ----- HK 305-9 1985-1988 VIN 9 8699-5</p>	<p>HS 305-5 1980-1984 & 1985-1986 VIN X 2 Bbl. 8699-4 ----- HS 305-6 1985-1986 VIN S, W w/F.I. & 1987-1989 VIN S 8699-6 ----- HS 305-7 1987-1989 VIN W 9471 ----- HS 305-9 1985-1988 VIN 9 8699-5</p>	<p>KS 305-5 1980-1984 & 1985-1986 VIN X 2 Bbl. 8699-4 ----- KS 305-6 1985-1986 VIN S, W w/F.I. & 1987-1989 VIN S 8699-6 ----- KS 305-7 1987-1989 VIN W 9471 ----- KS 305-9 1985-1988 VIN 9 8699-5</p>	<p>ER 305-5 1980-1984 & 1985-1986 VIN X 2 Bbl. 8699-4 ----- ER 305-6 1985-1986 VIN S, W w/F.I. & 1987-1989 VIN S 8699-6 ----- ER 305-7 1987-1989 VIN W. 9471 ----- ER 305-9 1985-1988 VIN 9 8699-5</p>
<p>3.0L 181 2962cc DOHC V6 Opel Engine, 24 Vlv 1997-2005</p> <p>VIN R 1997-2005 CADILLAC CATERA SATURN LS2, LW2, LW300, L300</p>	<p>HG 319-2 1997-1998 26189 ----- HG 319-4 1999-2005 26173 ----- Head Bolt Set HB 319-5 72906</p>	<p>HK 319-2 1997-1998 26189 ----- HK 319-4 1999-2001 CATERA 26173 ----- HK 319-5 2000-2005 L, LS, LW 26173-1</p>	<p>HS 319-2 1997-1998 26189 ----- HS 319-4 1999-2001 CATERA 26173 ----- HS 319-5 2000-2005 L, LS, LW 26173-1</p>	<p>KS 319-2 1997-1998 26189 ----- KS 319-4 1999-2001 CATERA 26173 ----- KS 319-5 2000-2005 L, LS, LW 26173-1</p>	<p>ER 319-2 1997-1998 26189 ----- KS 319-4 1999-2001 CATERA 26173 ----- KS 319-5 2000-2005 L, LS, LW 26173-1</p>

OIL PAN SET	INTAKE MANIFOLD SET	EXHAUST MANIFOLD SET	VALVE COVER SET	TIMING COVER SET	REAR SEAL SET	VALVE STEM SEAL SET
-------------	---------------------	----------------------	-----------------	------------------	---------------	---------------------

GM Buick, Cad, Chev, Geo, Olds, Pont, & Saturn: 6 Cyl

<p>OP 305-5 1980-1984 30411 -----</p> <p>OP 305-8 1985-1986 30512 -----</p> <p>OP 305-6 1987-1989 34501</p>	<p>MS 305-6 1980-1984 & 1985-1986 VIN X 2 Bbl. 91022 -----</p> <p>MS 305-7 1985-1986 VIN S, W w/F.I. 1985-1988 VIN 9 Fierro 1987-1989 VIN S Upper & Lower Set & Valve Cover Included 93020 -----</p> <p>VP 305-6 1987-1989 VIN W Upper & Lower Set 96041 -----</p> <p>MS 305-8 Upper Set 93610</p>	<p>EMS 305-5 1980-1986 Exc. Fierro 1987-1989 VIN S 90864 -----</p> <p>EMS 305-9 1985-1988 VIN 9 Fierro 93045 -----</p> <p>EMS 305-7 1987-1989 VIN W w/Cast Manifolds 93692 -----</p> <p>EMS 305-6 1987-1988 VIN W w/Stainless Steel Manifolds 93575</p>	<p>VS 305-5 1980-1984 & 1985-1986 VIN X 2 Bbl. 50182 -----</p> <p>VS 305-6 1985-1986 VIN S, W w/F.I. & 1987-1989 VIN S 50272 -----</p> <p>VS 305-9 1985-1988 VIN 9 Fierro 50077</p>	<p>TCS 305-5 1980-1086 45466 -----</p> <p>TCS 305-7 1987-1989 45828</p>	<p>RS 315-3 1980-1984 2 Pc. Rubber 40422 -----</p> <p>RS 315-5 1980-1984 Radial 40465 -----</p> <p>RS 315-6 1985-1989 11 mm Radial 40464</p>	<p>SS 302-5 1980 5112 O-Ring -----</p> <p>SS 305-5 1981-1986 1985-1988 Vin 9 1987-1989 Vin S 72530 -----</p> <p>SS 305-7 1987-1989 Vin W 72685</p>
<p>OP 319-2 1997-2001 CATERA Upper 30716 -----</p> <p>OP 319-4 1997-2001 CATERA Lower 30722</p>	<p>MS 319-2 1997-2001 CATERA Upper & Lower Set 96103 -----</p> <p>MS 319-4 1997-2001 CATERA Upper Set 96062 -----</p> <p>MS 319-5 2000-2005 L. LS. LW MODELS 96102</p>	<p>EMS 319-2 1997-2001 CATERA 96088 -----</p> <p>EMS 319-4 2000-2005 L, LS, LW 96089</p>	<p>VS 319-2 1997-2001 CATERA 50566 -----</p> <p>VS 319-4 2000-2005 L, LS, LW 50567</p>	<p>TCS 319-2 1997-2005 CamSeal 45603 -----</p> <p>TCS 319-4 1997-2005 Crk Seal 46014</p>	<p>RS 319-5 1997-2005 Radial 40671 -----</p> <p>RS 319-6 1997-2003 Radial PTFE</p>	<p>SS 319-5 1997-2005 71163</p>



ENGINE INFORMATION	HEAD GASKET	HEAD KIT With <u>NO</u> Valve Stem Seals	HEAD SET With Valve Stem Seals	KIT SET	SHORT BLOCK SET
--------------------	-------------	--	--------------------------------------	---------	-----------------

GM Buick, Cad, Chev, Geo, Olds, Pont, & Saturn: 6 Cyl

<p>3.0L 181 OHV V6 Buick Engine, 12 Vlv 1982-88</p> <p>VIN E 1982-1985 VIN L 1985-1988</p> <p>Head Bolt Replacement Required</p>	<p>HG 109-5 1982-1988 8723-1 -----</p> <p>Head Bolts HB 109-5 1985 Vin L 72725 -----</p> <p>HB 109-6 1986-1988 Vin L 72726</p>	<p>HK 109-7 1982-1985 VIN E 8723, -5 -----</p> <p>HK 109-11 1985-1988 VIN L 8723-8, -9</p>	<p>HS 109-7 1982-1983 VIN E 1 st Design .605 Guides Intake Not Included 8723 -----</p> <p>HS 109-6 1983-1985 VIN E 2nd Design .552 Guides Intake Not Included 8723-5 -----</p> <p>HS 109-10 1985-1987 VIN L Intake Not Included 8723-8 -----</p> <p>HS 109-11 1988 VIN L Intake Not Included 8723-9</p>	<p>KS 109-7 1982-1983 VIN E 1 st Design .605 Guides Intake Not Included 8723 -----</p> <p>KS 109-6 1983-1985 VIN E 2nd Design .552 Guides Intake Not Included 8723-5 -----</p> <p>KS 109-10 1985-1987 VIN L Intake Not Included 8723-8 -----</p> <p>KS 109-11 1988 VIN L Intake Not Included 8723-9</p>	<p>ER 109-7 1982-1985 VIN E 8723, -5 -----</p> <p>ER 109-10 1985-1987 VIN L Intake Not Included 8723-8 -----</p> <p>ER 109-11 1988 VIN L Intake Not Included 8723-9</p>
--	--	--	---	---	---



OIL PAN SET	INTAKE MANIFOLD SET	EXHAUST MANIFOLD SET	VALVE COVER SET	TIMING COVER SET	REAR SEAL SET	VALVE STEM SEAL SET
-------------	---------------------	----------------------	-----------------	------------------	---------------	---------------------

GM Buick, Cad, Chev, Geo, Olds, Pont, & Saturn: 6 Cyl

OP 109-8 1982-1985 VIN E 14 BOLT 30434 ----- OP 109-9 1985 VIN E 20 BOLT 1985-1988 VIN L 30522	VP 109-8 1982-1985 VIN E 96037 ----- VP 109-9 1985-1988 VIN L 96040-1	EMS 109-5 1982-1985 VIN E 90508 ----- EMS 109-9 1985-1988 VIN L 93046	VS 109-5 1982-1985 VIN E 50156 ----- VS 109-9 1985-1988 VIN L 50075 ----- VCG 109-2 1985-1988 VIN L Grommet Set 72134	TCS 109-7 1982-1985 VIN E ROPE 13044-2 ----- Use with OP 45006-1 ----- TCS 109-9 1982-1985 VIN E Radial Rubber Use with OP 45932 ----- TCS 109-8 1985-1988 VIN L Use with OP 45695	RS 109-5 1982-1988 ROPE 13044-2 ----- RS 109-6 1982-1988 2 Pc. Rubber 40613	SS 109-5 1982-1983 VIN E 1st. Design .605 Guide 70731 ----- SS 109-6 1983-1985 VIN E 2nd. Design .552 Guide 72623 ----- SS 109-8 1985-1987 VIN L 72667 ----- SS 109-7 1988 VIN L 72700
--	---	---	---	--	---	--



OIL PAN SET	INTAKE MANIFOLD SET	EXHAUST MANIFOLD SET	VALVE COVER SET	TIMING COVER SET	REAR SEAL SET	VALVE STEM SEAL SET
-------------	---------------------	----------------------	-----------------	------------------	---------------	---------------------

GM Buick, Cad, Chev, Geo, Olds, Pont, & Saturn: 6 Cyl

<p>OP 305-6 1988-1994 VIN T 1993 VIN W 34501</p>	<p>MS 305-8 1988-1990 VIN T FWD 1991 VIN T Buick 40001-800000 Upper Set 93610 ----- MS 305-9 1991 VIN T FWD All & Buick From 800001 1993 VIN W 1992-1994 VIN T FWD Upper Set 94944 ----- MS 305-7 1990-1992 VIN T RWD Camaro & Firebird Upper & Lower Set & Valve Covers 93020 ----- VP 305-5 1988-1990 VIN T FWD 1991 VIN T FWD All & Buick SN 40001 to 800000 Upper & Lower Set 96046 ----- VP 305-6 1991 VIN T FWD Buick from 800001 1993 VIN W 1992-1994 VIN T FWD Upper & Lower Set 96046</p>	<p>EMS 305-7 1988-1994 VIN T FWD 1993 VIN W 93692 ----- EMS 305-5 1990-1992 VIN T RWD Camaro & Firebird 90864</p>	<p>VS 305-7 1988-1994 VIN T FWD 1993 VIN W 50085 ----- VS 305-6 1990-1992 VIN T RWD Camaro & Firebird 50272 ----- VCG 305-2 1988-1994 VIN T FWD 1993 VIN W Grommet Set 72125</p>	<p>TCS 305-7 1988-1994 VIN T 1993 VIN W 45828</p>	<p>RS 315-6 1988-1994 VIN T 1993 VIN W 11 mm Radial 40464</p>	<p>SS 305-7 1988-1994 VIN T FWD 1993 VIN W 72685 ----- SS 305-5 1990-1992 VIN T RWD Camaro & Firebird 72530</p>
--	--	---	--	---	---	---



ENGINE INFORMATION	HEAD GASKET	HEAD KIT With <u>NO</u> Valve Stem Seals	HEAD SET With Valve Stem Seals	KIT SET	SHORT BLOCK SET
--------------------	-------------	--	--------------------------------------	---------	-----------------

GM Buick, Cad, Chev, Geo, Olds, Pont, & Saturn: 6 Cyl

<p>3.1L 189 3136cc OHV V6 Chevrolet Engine, 12 Vlv 1993-2005</p> <p>VIN M 1993-1999 VIN J 1999-2005</p> <p>Head Bolt Replacement Required</p>	<p>HG 305-6 1993-1999 VIN M 1999-2005 VIN J 9957</p> <p>Head Bolt Set HB 305-7 1993-1995 VIN M 74019</p> <p>HB 305-6 1996-1996 VIN M Achieva, Beretta, Ciera, Corica, Cutlass Supreme Grand Am Malibu, Skylark Models 1999 Malibu 1999 VIN J 2000-2003 VIN J Malibu 74017</p> <p>HB 305-8 1996-1998 VIN M Century, Cutlass Grand Prix, Lumina, Monte Carlo, Regal Models 1999 VIN M Exc. Malibu 2000-2005 VIN J Exc. Malibu Model 72892</p>	<p>HK 305-14 1993-1994 VIN M 1995-1996 VIN M 1 st Design Ball Rockers 9957</p> <p>HK 305-15 1999-2003 VIN J 9957-1</p> <p>HK 305-16 1995-1996 VIN M 2nd. Design Roller Rockers 1997-1999 VIN M 9957-2</p> <p>HK 305-17 2004-2005 VIN J 9957-3</p>	<p>HS 305-14 1993-1994 VIN M 1995-1996 VIN M 1 st Design Ball Rockers 9957</p> <p>HS 305-15 1999-2003 VIN J 9957-1</p> <p>HS 305-16 1995-1996 VIN M 2nd. Design Roller Rockers 1997-1999 VIN M 9957-2</p> <p>HS 305-17 2004-2005 VIN J 9957-3</p>	<p>KS 305-14 1993-1994 VIN M 1995-1996 VIN M 1 st Design Ball Rockers 9957</p> <p>KS 305-15 1999-2003 VIN J 9957-1</p> <p>KS 305-16 1995-1996 VIN M 2nd. Design Roller Rockers 1997-1999 VIN M 9957-2</p> <p>KS 305-17 2004-2005 VIN J 9957-3</p>	<p>ER 305-14 1993-1994 VIN M 1995-1996 VIN M 1 st Design Ball Rockers 9957</p> <p>ER 305-15 1999-2003 VIN J 9957-1</p> <p>ER 305-16 1995-1996 VIN M 2nd. Design Roller Rockers 1997-1999 VIN M 9957-2</p> <p>ER 305-17 2004-2005 VIN J 9957-3</p>
---	---	---	---	---	---

OIL PAN SET	INTAKE MANIFOLD SET	EXHAUST MANIFOLD SET	VALVE COVER SET	TIMING COVER SET	REAR SEAL SET	VALVE STEM SEAL SET
-------------	---------------------	----------------------	-----------------	------------------	---------------	---------------------

GM Buick, Cad, Chev, Geo, Olds, Pont, & Saturn: 6 Cyl

OP 305-9 1993-1999 VIN M 1999-2005 VIN J 30668	MS 305-16 1993-1994 VIN M 1995-1996 1st. Design Ball Rockers Upper & Lower Set 95536 ----- MS 305-17 1995-1999 VIN M 2nd Design Roller Rockers Upper & Lower Set 90562 ----- MS 305-13 1993-1999 VIN M Upper & Lower Set & Valve Covers 98004 ----- MS 305-10 1999-2003 VIN J Upper & Lower Set 90565 ----- MS 305-11 1999-2005 VIN J Upper Set 90505 ----- MS 305-12 1999-2005 VIN J Upper & Lower Set & Valve Covers 98003 ----- MS 305-14 1993-1999 VIN M Upper Set 91481 ----- THROTTLE BODY TB 109-12 1994-1996 VIN M w/MFI Century Ciera 61023	EMS 305-10 1993-1999 VIN M 1999-2004 VIN J 95586 ----- EMS 305-12 2004-2005 VIN J 96329 ----- THROTTLE BODY CONT. ----- TB 305-5 1990-1992 Camaro & Firebird VIN T 50883 ----- TB 305-6 1988-1994 Exc. Camaro & Firebird w/MFI VIN T 1993 VIN W w/MFI 60728 ----- TB 305-3 1993 VIN M w/MFI 1994-1996 VIN M w/MFI Exc. Century Ciera 1997-1999 VIN J, M w/MFI 2000-2005 VIN J w/MFI 61053	VS 305-10 1993-1999 VIN M 1999-2005 VIN J 50442	TCS 305-7 1993-1999 VIN M 1999-2005 VIN J 45828	RS 315-6 1993-1999 VIN M 1999-2005 VIN J 40464	SS 305-11 1993-1999 VIN M 1999 VIN J Cutlass Only 72851 ----- SS 305-12 1999 VIN J Exc Cutlass 2000-2005 VIN J 70829
---	--	---	--	--	---	--



ENGINE INFORMATION	HEAD GASKET	HEAD KIT With <u>NO</u> Valve Stem Seals	HEAD SET With Valve Stem Seals	KIT SET	SHORT BLOCK SET
--------------------	-------------	--	--------------------------------------	---------	-----------------

GM Buick, Cad, Chev, Geo, Olds, Pont, & Saturn: 6 Cyl

3.2L 194 OHV L6 Chevrolet Engine, 12 Vlv 1962-67	HG 302-5 1962-1967 8006	HK 302-3 1962-1967 8006-1	HS 302-3 1962-1967 8006-1	KS 302-3 1962-1967 8006-4	ER 302-3 1962-1967 8006-4
3.2L 196 OHV V6 Buick Engine, 12 Vlv 1978-79	HG 109-5 1978-1979 8723-1	HK 109-5 1978-1979 8723-4	HS 109-5 1978-1979 8723-4	KS 109-5 1978-1979 8723-4	ER 109-5 1978-1979 8723-4
3.3L 200 OHV V6 Chevrolet Engine, 12 Vlv 1978-79 VIN M 1978-1979	HG 304-5 1978-1979 8629	HK 304-5 1978-1979 8629	HS 304-5 1978-1979 8629	KS 304-5 1978-1979 8629	ER 304-5 1978-1979 8629
3.3L 204 OHV V6 Buick Engine, 12 Vlv 1989-93 VIN N 1989-1993	HG 109-10 1989-1993 9644 Head Bolt Set HB 109-4 1989-1993 72167	HK 109-14 1989-1991 9644 ----- HK 109-16 1992-1993 9644-3	HS 109-14 1989-1991 9644 ----- HS 109-16 1992-1993 9644-3	KS 109-14 1989-1991 9644 ----- KS 109-16 1992-1993 9644-3	ER 109-14 1989-1991 9644 ----- ER 109-16 1992-1993 9644-3

OIL PAN SET	INTAKE MANIFOLD SET	EXHAUST MANIFOLD SET	VALVE COVER SET	TIMING COVER SET	REAR SEAL SET	VALVE STEM SEAL SET
-------------	---------------------	----------------------	-----------------	------------------	---------------	---------------------

GM Buick, Cad, Chev, Geo, Olds, Pont, & Saturn: 6 Cyl

OP 302-3 1962-1967 30126-1	MS 302-3 1962-1967 9786	USE MS	VS 302-3 1962-1967 30126-1 ----- PS 302-5 Push Rod Cvr 1962-1967 13228	TCS 302-3 1962-1967 13198	RS 302-1 1962-1967 13241	SS 302-5 1962-1967 5112
OP 109-5 1978-1979 13398-1	VP 109-5 1978 96032 ----- VP 109-6 1979 96033	EMS 109-2 1978 90198 ----- EMS 109-5 1979 90508	VS 109-5 1978-1979 50156	TCS 109-5 1978-1979 Rope 45006 ----- TCS 109-6 Radial Rubber 45930	RS 109-5 1978-1979 Rope 13044-2 ----- RS 109-6 1978-1979 Option Radial Rubber 40613	SS 109-5 1978-1979 70731
OP 304-5 1978-1979 30386	MS 304-5 1978-1979 90391	EMS 304-5 1978-1979 90714	VS 304-5 1978-1979 50170	TCS 303-5 1978-1979 45121	RS 303-5 1978-1979 2 Pc Silicone 40013	SS 302-5 1978-1979 5112 O-Ring
OP 109-9 1989-1993 30522	MS 109-14 1989-1991 94066-1 ----- MS 109-15 1992-1993 94066-2	EMS 109-12 1989-1993 94052	VS 109-12 1989-1993 50080	TCS 109-10 1989-1993 45840	RS 109-5 1989-1990 Rope 13044-2 ----- RS 109-7 1991-1993 Radial 40621	SS 109-7 1989-1993 72700



ENGINE INFORMATION	HEAD GASKET	HEAD KIT With <u>NO</u> Valve Stem Seals	HEAD SET With Valve Stem Seals	KIT SET	SHORT BLOCK SET
--------------------	-------------	--	--------------------------------------	---------	-----------------

GM Buick, Cad, Chev, Geo, Olds, Pont, & Saturn: 6 Cyl

<p>3.4L 207 3393cc OHV V6 Chevrolet Engine, 12 Vlv 1993-2005</p> <p>VIN E 1999-2005 VIN S 1993-1995</p> <p>Head Bolt Replacement Required</p>	<p>HG 305-8 1993-1995 VIN S 9105 -----</p> <p>HG 305-9 1999-2005 VIN E 9071</p> <p>Head Bolt Set HB 305-4 1993-1995 VIN S 72857 -----</p> <p>HB 305-6 1999 VIN E 2000-2005 VIN E Exc. Monte Carlo & Impala Models 74017 -----</p> <p>HB 305-8 2000-2005 VIN E Monte Carlo & Impala Models 72892</p>	<p>HK 305-12 1993-1995 VIN S 9105 -----</p> <p>HK 305-8 1999 VIN E 9071 -----</p> <p>HK 305-11 2000-2003 VIN E 9071-1 -----</p> <p>HK 305-18 2004-2005 VIN E 9071-2</p>	<p>HS 305-12 1993-1995 VIN S 9105 -----</p> <p>HS 305-8 1999 VIN E 9071 -----</p> <p>HS 305-11 2000-2003 VIN E 9071-1 -----</p> <p>HS 305-18 2004-2005 VIN E 9071-2</p>	<p>KS 305-12 1993-1995 VIN S 9105 -----</p> <p>KS 305-8 1999 VIN E 9071 -----</p> <p>KS 305-11 2000-2003 VIN E 9071-1 -----</p> <p>KS 305-18 2004-2005 VIN E 9071-2</p>	<p>ER 305-12 1993-1995 VIN S 9105 -----</p> <p>ER 305-8 1999 VIN E 9071 -----</p> <p>ER 305-11 2000-2003 VIN E 9071-1 -----</p> <p>ER 305-18 2004-2005 VIN E 9071-2</p>
<p>3.4L 207 3393cc DOHC V6 Chevrolet Engine, 24 Vlv 1991-97</p> <p>VIN X 1991-1997 LUMINA, MONTE CARLO, GRAND AM</p>	<p>HG 318-5 1991-1997 VIN X 9113</p>	<p>HK 318-5 1991-1995 VIN X 9113-1 -----</p> <p>HK 318-6 1996-1997 VIN X 9113-2</p>	<p>HS 318-5 1991-1995 VIN X 9113-1 -----</p> <p>HS 318-6 1996-1997 VIN X 9113-2</p>	<p>KS 318-5 1991-1995 VIN X 9113-1 -----</p> <p>KS 318-6 1996-1997 VIN X 9113-2</p>	<p>ER N/A</p>
<p>3.7L 225 OHV V6 Buick Engine, 12 Vlv 1964-67</p>	<p>HG 109-5 1964-1967 8723-1</p>	<p>HK N/A</p>	<p>HS N/A</p>	<p>KS N/A</p>	<p>ER N/A</p>

OIL PAN SET	INTAKE MANIFOLD SET	EXHAUST MANIFOLD SET	VALVE COVER SET	TIMING COVER SET	REAR SEAL SET	VALVE STEM SEAL SET
-------------	---------------------	----------------------	-----------------	------------------	---------------	---------------------

GM Buick, Cad, Chev, Geo, Olds, Pont, & Saturn: 6 Cyl

OP 305-6 1993-1995 VIN S 34501 ----- OP 305-9 1999-2005 VIN E 30668	MS 305-7 1993-1995 VIN S Upper & Lower Set & Valve Covers 93020 ----- MS 305-11 1999-2005 VIN E Upper Set 90505 ----- MS 305-10 1999-2003 VIN E Upper & Lower Set 90565 ----- MS 305-12 1999-2005 VIN E Upper & Lower Set & Valve Covers 98003 ----- THROTTLE BODY ----- TB 305-2 1993-1995 VIN S w/MFI 1999 VIN E w/MFI 60983	EMS 305-5 1993-1995 VIN S 90864 ----- EMS 305-10 1999-2003 VIN E 95586 ----- EMS 305-12 2004-2005 VIN E 96329 ----- THROTTLE BODY CONT. ----- TB 305-3 2000-2005 VIN E 61053	VS 305-8 1993-1995 VIN S 50272 ----- VS 305-10 1999-2005 VIN E w/WO SEAL 50442 ----- VCG 305-4 1999-2005 VIN E Grommet Set 71044	TCS 305-7 1993-1995 VIN S 1999-2005 VIN E 45828	RS 315-6 1993-1995 VIN S 1999-2005 VIN E Radial 40464	SS 305-5 1993-1995 VIN S 72530 ----- SS 305-11 1999 VIN E 72851 ----- SS 305-12 2000-2005 VIN E 70829
OP 305-6 1991-1997 VIN X 34501	MS 318-2 Upper & Lower Set 1991-1995 VIN X 95822 ----- MS 318-4 Upper & Lower Set 1996-1997 VIN X 95804	EMS 318-2 1991-1995 VIN X 95802 ----- EMS 318-3 1996-1997 VIN X 95803	VS 318-2 1991-1995 VIN X w/Spark Plug Seals 50466 ----- VS 318-4 1996-1997 VIN X w/Spark Plug Seals 50472	TCS 318-2 1991-1997 VIN X Crk Seal Set 45970	RS 315-6 1991-1997 VIN X Radial 40464	SS 138-8 1991-1997 VIN X 72862
OP 109-5 1964-1967 13398-1	MS 109-5 1964-1967 9943	EMS 109-2 1964-1967 90198	VS 109-2 1964-1967 13160-1	TCS 109-2 1964-1966 Cover #1358076 13001 ----- TCS 106-5 1966-1967 Cover #1375157 45006	RS 109-5 1964-1967 Rope 13044-1 ----- RS 109-6 1964-1967 2Pc. Rubber 40613	SS N/A



ENGINE INFORMATION	HEAD GASKET	HEAD KIT With <u>NO</u> Valve Stem Seals	HEAD SET With Valve Stem Seals	KIT SET	SHORT BLOCK SET
--------------------	-------------	--	--------------------------------------	---------	-----------------

GM Buick, Cad, Chev, Geo, Olds, Pont, & Saturn: 6 Cyl

3.8L 229 OHV V6 Chevrolet Engine, 12 Vlv 1980-84 VIN K 1980-1982 VIN 9 1983-1984	HG 304-5 1980-1984 8721	HK 304-5 1980-1984 8721	HS 304-5 1980-1984 8721	KS 304-5 1980-1984 8721	ER 304-5 1980-1984 8721
3.8L 230 OHV L6 Chevrolet Engine, 12 Vlv 1963-70	HG 302-5 1963-1970 8006	HK 302-3 1963-1970 8006	HS 302-3 1963-1970 8006	KS 302-3 1963-1970 8006-4	ER 302-3 1963-1970 8006-4



OIL PAN SET	INTAKE MANIFOLD SET	EXHAUST MANIFOLD SET	VALVE COVER SET	TIMING COVER SET	REAR SEAL SET	VALVE STEM SEAL SET
-------------	---------------------	----------------------	-----------------	------------------	---------------	---------------------

GM Buick, Cad, Chev, Geo, Olds, Pont, & Saturn: 6 Cyl

OP 304-5 1980-1984 30386	MS 304-5 1980-1984 90391	EMS 304-5 1980-1984 90714	VS 304-5 1980-1984 50170	TCS 303-5 1980-1984 45121	RS 303-5 1980-1984 2 Pc. Silicone 40013	SS 302-5 1980 O-Ring 5112 ----- SS 304-5 1981-1984 72529
OP 302-3 1963-1970 30126-1	MS 302-3 1963-1970 9786	USE MS	VS 302-3 1963-1970 13173-1 ----- PS 302-5 Push Rod Cover 1963-1970 13228	TCS 302-3 1963-1970 13198	RS 302-1 1963-1968 2 Pc. Rubber 13241 ----- RS 303-5 1969-1970 2 Pc. Silicone 40013	SS 302-5 1963-1970 O-Ring 5112



ENGINE INFORMATION	HEAD GASKET	HEAD KIT With <u>NO</u> Valve Stem Seals	HEAD SET With Valve Stem Seals	KIT SET	SHORT BLOCK SET
--------------------	-------------	--	--------------------------------------	---------	-----------------

GM Buick, Cad, Chev, Geo, Olds, Pont, & Saturn: 6 Cyl

3.8L 231 OHV V6 Buick Engine, 12 Vlv 1975-1995 EXC. TURBO & SUPERCHARGED VIN A 1977-1987 VIN B 1986-1987 VIN C 1975-1977 VIN C 1988-1991 VIN L 1990-1995 VIN 2 1978-1979 VIN 3 1984-1988	HG 109-5 1975-1988 Exc. Turbo VIN 7 1986-87 8723-1 ----- HG 109-12 1988-91 VIN C (3800) 9556 ----- HG 109-10 1991 VIN C 1990-1995 VIN L 9644	HK 109-5 1975-1983 VIN A, C, 2 (RWD) VP INT. n/l 8723-4 ----- HK 109-7 1984-85 VIN A (RWD) 1986-88 VIN A (RWD) w/o F.I. VP INT. n/l 8723-5 ----- HK 109-15 1984-1985 VIN B, 3 (FWD) w/F.I. VP INT. n/l 8723-6 ----- HK 109-11 1986-1988 VIN B, 3 (FWD) w/F.I. VP Int. N/l 8723-8/9 ----- HK 109-12 1988-1991 VIN C (3800) 9556	HS 109-5 1975-1983 .605 O.D. Guide VIN A, C, (Rwd) VP INT. n/l 8723-4 ----- HS 109-6 1983 .552 O.D. Guide 1984-85 VIN A (RWD) 1986-88 VIN A (RWD) w/o F.I. VP Int. N/l 8723-5 ----- HS 109-15 1984-1985 VIN B, 3 (FWD) w/F.I. VP INT. n/l 8723-6 ----- HS 109-11 1986-1988 VIN B, 3 (FWD) w/F.I. VP Int. N/l 8723-8/9 ----- HS 109-12 1988-1991 VIN C (3800) 9556 ----- HS 109-16 1990-1996 VIN L -- 1993-1995 VIN L Upper Int N/l 9644-1	KS 109-5 1975-1983 .605 O.D. Guide VIN A, C, (Rwd) VP INT. n/l 14 Bolt OP 8723-4 ----- KS 109-6 1983 .552 O.D. Guide 1984-85 VIN A (RWD) 1986-88 VIN A (RWD) w/o F.I. VP Int. N/l 14 Bolt OP 8723-5 ----- KS 109-15 1984-1985 VIN B, 3 (FWD) w/F.I. VP INT. n/l 20 Bolt OP 8723-6 ----- KS 109-11 1986-1988 VIN B, 3 (FWD) w/F.I. VP Int. N/l 20 Bolt OP 8723-8/9 ----- KS 109-12 1988-1991 VIN C (3800) 20 Bolt OP 9556 ----- KS 109-16 1990-1996 VIN L -- 1993-1995 VIN L Upper Int N/l 9644-1	ER 109-5 1975-1983 .605 O.D. Guide VIN A, C, 2(Rwd) VP INT. n/l 8723-4 ----- ER 109-6 1983 .552 O.D. Guide 1984-85 VIN A (RWD) 1986-88 VIN A (RWD) w/o F.I. VP Int. N/l 8723-5 ----- ER 109-15 1984-1985 VIN B, 3 (FWD) w/F.I. VP INT. n/l 8723-6 ----- ER 109-11 1986-1988 VIN B, 3 (FWD) w/F.I. VP Int. N/l 8723-8 ----- ER 109-12 1988-1991 VIN C (3800) 9556 ----- ER 109-16 1990-1996 VIN L -- 1993-1995 VIN L Upper Int N/l 9644-1
--	--	---	---	---	--



ENGINE INFORMATION	HEAD GASKET	HEAD KIT With <u>NO</u> Valve Stem Seals	HEAD SET With Valve Stem Seals	KIT SET	SHORT BLOCK SET
--------------------	-------------	--	--------------------------------------	---------	-----------------

GM Buick, Cad, Chev, Geo, Olds, Pont, & Saturn: 6 Cyl

<p>3.8L 231 OHV V6 Buick Engine, 12 Vlv 1995-2008</p> <p>VIN K 1995-2005 VIN 2 2004-2008</p>	<p>HG 109-14L Left Hand 1995-2008 9917 -----</p> <p>HG 109-15R Right Hand 1995-2008 9918</p> <p>Head Bolts HG 109-7 1995-2006 74033</p>	<p>HK 109-20 1995-1997 VIN K FWD 1st Design 9917 -----</p> <p>HK 109-21 1995-1997 VIN K RWD 1st Design Camaro & Firebird 9917-1 -----</p> <p>HK 109-22 1997-2002 VIN K RWD 2nd. Design Camaro & Firebird 9917-2 -----</p> <p>HK 109-23 1997-2005 VIN K, 2 FWD 2nd. Design 9917-3</p>	<p>HS 109-20 1995-1997 VIN K FWD 1st Design 9917 -----</p> <p>HS 109-21 1995-1997 VIN K RWD 1st Design Camaro & Firebird 9917-1 -----</p> <p>HS 109-22 1997-2002 VIN K RWD 2nd. Design Camaro & Firebird 9917-2 -----</p> <p>HS 109-23 1997-2005 VIN K, 2 FWD 2nd. Design 9917-3</p>	<p>KS 109-20 1995-1997 VIN K FWD 1st Design 9917 -----</p> <p>KS 109-21 1995-1997 VIN K RWD 1st Design Camaro & Firebird 9917-1 -----</p> <p>KS 109-22 1997-2002 VIN K RWD 2nd. Design Camaro & Firebird 9917-2 -----</p> <p>KS 109-23 1997-2005 VIN K, 2 FWD 2nd. Design 9917-3</p>	<p>ER 109-20 1995-1997 VIN K FWD 1st Design 9917 -----</p> <p>ER 109-21 1995-1997 VIN K RWD 1st Design Camaro & Firebird 9917-1 -----</p> <p>ER 109-22 1997-2002 VIN K RWD 2nd. Design Camaro & Firebird 9917-2 -----</p> <p>ER 109-23 1997-2005 VIN K, 2 FWD 2nd. Design 9917-3</p>
<p>3.8L 231 OHV Supercharged V6 Buick Engine, 12 Vlv 1991-2005</p> <p>SUPERCHARGED ENGINE VIN 1 1991-2005 (S/C) VIN 4 2004-2006 (S/C)</p>	<p>HG 109-8 1991-1995 9088 -----</p> <p>HG 109-9 1996-2003 9089</p> <p>Head Bolts HB 109-4 1991-1995 72167 -----</p> <p>HB 109-7 1996-2001 74033</p>	<p>HK 109-26 1991-1995 9088 -----</p> <p>HK 109-28 1996-2003 1 st. Design Intake Seals 1997 2nd. Design Intake Seals 9089-1,-2</p>	<p>HS 109-26 1991-1995 9088 -----</p> <p>HS 109-27 1996-1997 1 st. Design Intake Seals 1997 2nd. Design Intake Seals 9089-1 -----</p> <p>HS 109-28 1998-2003 9089-2</p>	<p>KS 109-26 1991-1995 9088 -----</p> <p>KS 109-27 1996-1997 1 st. Design Intake Seals 1997 2nd. Design Intake Seals 9089PT-1 -----</p> <p>KS 109-28 1998-2003 9089-2</p>	<p>ER 109-26 1991-1995 9088 -----</p> <p>ER 109-27 1996-1997 1 st. Design Intake Seals 1997 2nd. Design Intake Seals 9089-1 -----</p> <p>ER 109-28 1998-2003 9089-2</p>

OIL PAN SET	INTAKE MANIFOLD SET	EXHAUST MANIFOLD SET	VALVE COVER SET	TIMING COVER SET	REAR SEAL SET	VALVE STEM SEAL SET
-------------	---------------------	----------------------	-----------------	------------------	---------------	---------------------

GM Buick, Cad, Chev, Geo, Olds, Pont, & Saturn: 6 Cyl

<p>OP 109-10 1995-1999 VIN K (RWD) 2000-2005 VIN K, 2 Camaro Firebird Windage Tray 34410 30767 ----- OP 109-12 2000-2005 Bonneville LeSabre Park Avenue VIN K (FWD) 30699</p>	<p>MS 109-18 1995-1997 VIN K 1 st. Design Lower Set 95809 ----- MS 109-20 1997-2005 VIN K, 2 2nd Design Lower Set 95809-1 ----- MS 109-19 1995-2005 VIN K Exc. Camaro, Firebird Upper Set 95812 ----- MS 109-17 1995-2002 VIN K Camaro, Firebird Upper Set 95746</p>	<p>EMS 109-14 1995-2002 Vin K Camaro & Firebird 95811 ----- EMS 109-15 1995-2008 VIN K, ,2 Exc. Camaro & Firebird 95829 THROTTLE BODY TB 109-5 1995-2005 FWD VIN K Exc. Cam/Fire B 61093 ----- TB 109-6 1995-1998 Camaro Fire Bird VIN K 61027</p>	<p>VS 109-12 1988-2006 VIN C, K, L 50080 THROTTLE BODY CONT. TB 109-8 1999-2002 Camaro & Fire Bird VIN K 60661 ----- TB 109-9 2004-2008 VIN 2 61447</p>	<p>TCS 109-12 1995-2005 VIN K Use w/Oil Pan 45971</p>	<p>RS 109-8 1995-2005 VIN K 40621-1</p>	<p>SS 109-10 1996-2006 VIN K, 2 72144</p>
<p>OP 109-9 1991-1994 30522 ----- OP 109-10 1995-1999 & 2000-2001 Grand Prix Regal Windage Tray 34410</p>	<p>MS 109-16 1991-1995 Lower Set 94918-1 ----- MS 109-23 1996-1997 Lower Set 1st. Design End Seals 95977 ----- MS 109-24 1997-2001 Lower Set 2nd. Design End Seals 95977-1 ----- MS 109-25 1991-1995 Upper Set 95741 ----- MS 109-26 1996-2001 Upper Set 95744</p>	<p>EMS 109-12 1991-1995 94052 ----- EMS 109-18 1996-2003 95808</p>	<p>VS 109-12 1991-1995 50080 ----- VS 109-14 1996-2004 50465</p>	<p>TCS 109-10 1991-1995 Use w/Oil Pan 45840 ----- TCS 109-12 1996-2004 Use w/Oil Pan 45971</p>	<p>RS 109-7 1991-1995 40621 ----- RS 109-8 1996-2001 40621-1</p>	<p>SS 109-7 1991-1995 72700 ----- SS 109-9 1996-1997 72882 ----- SS 109-10 1998-2001 72144</p>



ENGINE INFORMATION	HEAD GASKET	HEAD KIT With <u>NO</u> Valve Stem Seals	HEAD SET With Valve Stem Seals	KIT SET	SHORT BLOCK SET
--------------------	-------------	--	--------------------------------------	---------	-----------------

GM Buick, Cad, Chev, Geo, Olds, Pont, & Saturn: 6 Cyl

<p>3.8L 231 OHV Turbo V6 Buick Engine, 12 Vlv 1978-89</p> <p>TURBO ENGINE VIN G 1978 VIN 3 1978-1982 VIN 7 1986-1987 & 1989 VIN 9 1984-1985</p>	<p>HG 109-5 1978-85 8723-1 ----- HG 109-7 1986-87 1989 Turbo VIN 7 (RWD) 9441</p>	<p>HK 109-5 1978-1983 Valley Pan N/I 8723-4 ----- HK 109-7 1985 VIN 9 Turbo Valley Pan N/I 8723-5 ----- HK 109-24 1986-1988 VIN 7 Turbo Valley Pan N/I 9441 ----- HK 109-25 1989 VIN 7 9441-1</p>	<p>HS 109-5 1978-1983 .605 O.D. Guide Valley Pan N/I 8723-4 ----- HS 109-6 1983 .552 O.D. Guide 1984-1985 VIN 9 Turbo Valley Pan N/I 8723-5 ----- HS 109-24 1986-1987 1989 VIN 7 Turbo Valley Pan N/I 9441 ----- HK 109-25 1989 VIN 7 9441-1</p>	<p>KS 109-5 1978-1983 .605 O.D. Guide Valley Pan N/I 8723-4 ----- KS 109-6 1983 .552 O.D. Guide 1984-1985 VIN 9 Turbo Valley Pan N/I 8723-5 ----- KS 109-24 1986-1987 1989 VIN 7 Turbo Valley Pan N/I 9441 ----- KS 109-25 1989 VIN 7 9441-1</p>	<p>ER 109-5 1978-1983 .605 O.D. Guide Valley Pan N/I 8723-4 ----- ER 109-6 1983 .552 O.D. Guide 1984-1985 VIN 9 Turbo Valley Pan N/I 8723-5 ----- ER 109-24 1986-1987 1989 VIN 7 Turbo Valley Pan N/I 9441 ----- ER 109-25 1989 VIN 7 9441-1</p>
<p>3.8L 235 OHV L6 Chevrolet Engine, 12 Vlv 1950-62</p>	<p>HG 301-1 1950-52 7529 ----- HG 301-5 1953-1962 7619</p>	<p>HK 301-1 1950-52 7539 ----- HK 301-5 1953-1962 7619</p>	<p>HS 301-1 1950-52 7539 ----- HS 301-5 1953-1962 7619</p>	<p>KS 301-1 1950-52 7539 ----- KS 301-5 1953-1962 7619</p>	<p>ER 301-1 1950-52 7539 ----- ER 301-5 1953-1962 7619</p>
<p>4.1L 250 OHV L6 Chevrolet Engine, 12 Vlv 1975-79</p> <p>INTEGRAL HEADS</p>	<p>HG 307-5 1975-1979 8501-1</p>	<p>HK 307-5 1975-1979 8501-3</p>	<p>HS 307-5 1975-1979 8501-3</p>	<p>KS 307-5 1975-1979 8501-3</p>	<p>ER 307-5 1975-1979 8501-3</p>
<p>4.1L 250 OHV L6 Chevrolet Engine, 12 Vlv 1965-79</p> <p>VIN D 1972-1979</p>	<p>HG 302-5 1965-1979 8006</p>	<p>HK 302-5 1965-1979 8006-1</p>	<p>HS 302-5 1965-1979 8006-1</p>	<p>KS 302-5 1965-1979 8006-4</p>	<p>ER 302-5 1965-1979 8006-4</p>



OIL PAN SET	INTAKE MANIFOLD SET	EXHAUST MANIFOLD SET	VALVE COVER SET	TIMING COVER SET	REAR SEAL SET	VALVE STEM SEAL SET
-------------	---------------------	----------------------	-----------------	------------------	---------------	---------------------

GM Buick, Cad, Chev, Geo, Olds, Pont, & Saturn: 6 Cyl

<p>OP 109-5 1978-1984 14 Bolt Pan 13398-1 ----- OP 109-7 1984-1989 VIN 7 Turbo (RWD) 20 Bolt Pan 30521</p>	<p>VP 109-5 1978 960032 ----- VP 109-6 1979 1982-1983 Exc Rivera 1984-1987 VIN 7, 9 & 1989 VIN 7 96033 ----- VP 109-8 1980-1981 & 1982-1983 Rivera 96037</p>	<p>EMS 109-2 1978 90198 ----- EMS 109-5 1979-89 90508</p>	<p>VS 109-5 1978-1987 50156 ----- VS 109-9 1989 w/ Grommets 50075 ----- VCG 109-2 Grommet Set 1989 72134</p>	<p>TCS 106-5 1978-1987 -- 1984 -1987 20 Bolt OP Use w/OP ROPE 45006 ----- TCS 109-6 1978-1989 -- 1984-1989 20 Bolt OP Use w/OP RUBBER 45930</p>	<p>RS 109-5 1978-1987 & 89 Rope 13044-2 ----- RS 109-6 1978-1987 & 89 2 PC. Rubber 40613</p>	<p>SS 109-5 1978-1983 1st Design .605 O.D. Guides 70731 ----- SS 109-6 1983-89 2nd. Design .552 O.D. Guides 72623</p>
<p>OP 301-5 1950-1962 5041/5153</p>	<p>MS 301-5 1950-1962 9193</p>	<p>USE MS</p>	<p>VS 301-5 1950-1962 50190</p>	<p>TCS 301-5 1950-1962 45114</p>	<p>RS 301-5 1950-1954 Rope 5048 ----- RS 301-6 1955-1962 2 Pc. Rubber 13363</p>	<p>SS 302-5 1950-1962 5112 O-Ring</p>
<p>OP 302-3 1975-1979 30126</p>	<p>MS N/A Integral Head</p>	<p>EMS 307-5 1975-1979 90324</p>	<p>VS 307-5 1975-1979 50181</p>	<p>TCS 302-3 1975-1979 13198</p>	<p>RS 303-5 1975-1979 2 Pc. Silicone 40013</p>	<p>SS 302-5 1975-1979 5112 O-Ring</p>
<p>OP 302-3 1965-1979 30126</p>	<p>MS 302-3 1965-1979 9786</p>	<p>USE MS</p>	<p>VS 302-3 1965-1979 13173-1</p>	<p>TCS 302-3 1965-1979 13198</p>	<p>RS 302-1 1962-1968 Not in Kits 13241 ----- RS 303-5 1968-1979 40013</p>	<p>SS 302-5 1968-1979 5112 O-Ring</p>



ENGINE INFORMATION	HEAD GASKET	HEAD KIT With <u>NO</u> Valve Stem Seals	HEAD SET With Valve Stem Seals	KIT SET	SHORT BLOCK SET
--------------------	-------------	--	--------------------------------------	---------	-----------------

GM Buick, Cad, Chev, Geo, Olds, Pont, & Saturn: 6 Cyl

4.1L 252 OHV V6 Buick Engine, 12 Vlv 1980-85 VIN 4 1980-1985	HG 109-5 1980-1985 8723-1	HK 109-7 1980-1985 Valley Pan Not Included 8723, -5	HS 109-7 1980-1983 1st Design .605 O.D. Guides Valley Pan Not Included 8723 ----- HS 109-6 1983-1985 2nd. Design .552 O.D. Guides Valley Pan Not Included 8723-5	KS 109-7 1980-1983 1st Design .605 O.D. Guides Valley Pan Not Included 8723 ----- KS 109-6 1983-1985 2nd. Design .552 O.D. Guides Valley Pan Not Included 8723-5	ER 109-7 1980-1983 1st Design .605 O.D. Guides Valley Pan Not Included 8723 ----- ER 109-6 1983-1985 2nd. Design .552 O.D. Guides Valley Pan Not Included 8723-5
4.3L 261 OHV L6 Chevrolet Engine, 12 Vlv 1955-62	HG 301-4 1955-1962 7782	HK 301-4 1955-1962 7782	HS 301-4 1955-1962 7782	KS 301-4 1955-1962 7782	ER 301-4 1955-1962 7782
4.3L 262 OHV V6 Chevrolet Engine, 12 Vlv 1985-93 VIN Z 1985-93	HG 304-7 1985-1993 9354-1	HK 304-7 1985 1987-1991 9354 ----- HK 304-8 1986 & 1992 VIN Z 9354-1 ----- HK 304-9 1993 VIN Z 9354-2	HS 304-7 1985 1987-1991 9354 ----- HS 304-8 1986 & 1992 VIN Z 9354-1 ----- HS 304-9 1993 VIN Z 9354-2	KS 304-7 1985 1987-1991 9354 ----- KS 304-8 1986 & 1992 VIN Z 9354-1 ----- KS 304-9 1993 VIN Z 9354-2	ER 304-7 1985 1987-1991 9354 ----- ER 304-8 1986 & 1992 VIN Z 9354-1 ----- ER 304-9 1993 VIN Z 9354-2

OIL PAN SET	INTAKE MANIFOLD SET	EXHAUST MANIFOLD SET	VALVE COVER SET	TIMING COVER SET	REAR SEAL SET	VALVE STEM SEAL SET
-------------	---------------------	----------------------	-----------------	------------------	---------------	---------------------

GM Buick, Cad, Chev, Geo, Olds, Pont, & Saturn: 6 Cyl

OP 109-5 1980-1985 13398-1	VP 109-8 1980-1985 96037	EMS 109-5 1980-1985 90508	VS 109-5 1980-1985 50156	TCS 106-5 1980-1985 Rope 45006 ----- TCS 109-6 1980-1985 Rubber 45930	RS 109-5 1980-1985 Rope 13044-2 ----- RS 109-6 1980-1985 2 PC. Rubber 40613	SS 109-5 1980-1983 1st Design .605 O.D. Guides 70731 ----- SS 109-6 1983-85 2nd. Design .552 O.D. Guides 72623
OP 301-5 1955-1962 5041/5153	MS 301-5 1955-1962 9193	USE MS	VS 301-5 1955-1962 50189	TCS 301-5 1955-1962 45114	RS 301-6 1955-1962 2 Piece Rubber 13363	SS 302-5 1955-1962 5112 O-Ring
OP 304-5 1985 30386 ----- OP 304-7 1986-1995 34502	MS 304-6 1985-1986 93040 ----- MS 304-7 1987-1995 VIN Z 93346	EMS 304-6 1985-1993 VIN Z 90746	VS 304-6 1985-1993 Flat Silicone 50086	TCS 303-5 1985-93 VIN Z Use w/Oil Pan 45121	RS 303-5 1985 2 Pc. Silicone 40013 ----- RS 303-8 Radial 1986-1993 40520 ----- RS 303-9 1986-1993 Radial PTFE 40626	SS 304-5 Int. & Exh. 1985-1986 72529 ----- SS 304-7 Int. & Exh. 1987-1993 72530 72876



ENGINE INFORMATION	HEAD GASKET	HEAD KIT With <u>NO</u> Valve Stem Seals	HEAD SET With Valve Stem Seals	KIT SET	SHORT BLOCK SET
--------------------	-------------	--	--------------------------------------	---------	-----------------

GM Buick, Cad, Chev, Geo, Olds, Pont, & Saturn: V8

<p>4.0L 244 DOHC V8 Oldsmobile Engine, 32 Vlv 1995-03</p> <p>VIN C 1995-1999 & 2001-2003 NORTHSTAR CADILLAC, OLDS</p>	<p>HG 244-2R 1995-2003 Right 26153 ----- HG 244-4L 1995-2003 Left 26152 ----- Head Bolts HB 209-5 1995-1999 72186 ----- HB 244-4 2001-2003 72187</p>	<p>HK 244-2 1995-1999 26152 ----- HK 244-3 2001 26152-1 ----- HK 244-4 2002-2003 26152-2</p>	<p>HS 244-2 1995-1999 26152 ----- HS 244-3 2001 26152-1 ----- HS 244-4 2002-2003 26152-2</p>	<p>KS 244-2 1995-1999 26152 ----- KS 244-3 2001 26152-1 ----- KS 244-4 2002-2003 26152-2</p>	<p>ER 244-2 1995-1999 26152 ----- ER 244-3 2001 26152-1 ----- ER 244-4 2002-2003 26152-2</p>
<p>4.1L 252 OHV V8 Cadillac Engine, 16 Vlv 1982-88</p> <p>VIN 7 1987-1988 VIN 8 1982-1987</p>	<p>HG 209-4 1982-1988 8753 ----- HG 209-5 1987-1988 Vin 7 Allanté 8753-1</p> <p>Head Bolts HB 209-5 1983-1988 72186</p>	<p>HK 209-3 1982-1984 1985 W/Steel Valve Cover 8753 ----- HK 209-5 1985 W/Alum Valve Cover 1986-1987 Vin 8 8753-1 ----- HK 209-4 1987-1988 Vin 7 8753-4</p>	<p>HS 209-3 1982-1984 1985 W/Steel Valve Cover 8753 ----- HS 209-5 1985 W/Alum Valve Cover 1986-1987 Vin 8 8753-1 ----- HS 209-4 1987-1988 Vin 7 8753-4</p>	<p>KS 209-3 1982-1984 1985 W/Steel Valve Cover 8753 ----- KS 209-5 1985 W/Alum Valve Cover 1986-1987 Vin 8 8753-1 ----- KS 209-4 1987-1988 Vin 7 8753-4</p>	<p>ER 209-3 1982-1984 1985 W/Steel Valve Cover 8753 ----- ER 209-5 1985 W/Alum Valve Cover 1986-1987 Vin 8 8753-1 ----- ER 209-4 1987-1988 Vin 7 8753-4</p>

OIL PAN SET	INTAKE MANIFOLD SET	EXHAUST MANIFOLD SET	VALVE COVER SET	TIMING COVER SET	REAR SEAL SET	VALVE STEM SEAL SET
-------------	---------------------	----------------------	-----------------	------------------	---------------	---------------------

GM Buick, Cad, Chev, Geo, Olds, Pont, & Saturn: V8

<p>OP 212-5 1995-2003 30704</p>	<p>MS 244-5 1995-1999 93222 ----- MS 244-6 2001-2003 93313</p>	<p>EMS 244-5 1995-1999 93455 ----- EMS 244-6 2001-2003 93371</p>	<p>VS 244-5 1995-1999 w/Spark Plug Seals & Grommets 50524 ----- VS 244-6 2001-2003 w/Spark Plug Seals & Grommets 50526</p>	<p>TCS 244-2 1995-2003 Cam Frt. Seal Set 46011 ----- TCS 244-4 1995-1997 1998 1 st. Design Crank Frt. Seal Set 46012 ----- TCS 244-5 1998 2nd. Design 1999 Crank Frt. Seal Set 46018 ----- TCS 244-6 2001-2003 Crank Frt. Seal Set 46013</p>	<p>RS 244-2 1995-1996 1 st. Design 9.0 mm Radial 40669 ----- RS 244-4 1996-2003 2nd Design 12.0 mm Radial PTFE 40670</p>	<p>SS 244-2 1995-1999 71146X2 ----- SS 244-4 2001 71042X2 ----- SS 244-5 2002-2003 71043</p>
<p>OP 209-2 1982-1984 1985 Exc. Transverse ----- OP 209-5 1985 Transverse 1986-1988 30525</p>	<p>MS 209-2 1982-1987 Vin 8 Must be used W/ VS Set 94116 ----- MS 209-5 1987-1988 Vin 7 Upper Set 94613</p>	<p>EMS 209-2 1982-1988 91384</p>	<p>VS 209-2 1982-1984 1985 W/Steel VC 50219 ----- VS 209-5 1985 W/Alum VC 1986-1987 Vin 8 50073 ----- VS 209-4 1987-1988 Vin 7 50074</p>	<p>TCS 209-2 1982-1984 1985 Exc. Transverse 45522 ----- TCS 209-5 1985 Transverse 1986 W/O Beaded Flange on WP Vin 8 45522-1 ----- TCS 209-6 1986 W/Beaded Flange on WP Vin 8 1987-1988 All 45522-2</p>	<p>RS 209-5 1982-1984 1985 Exc. Transverse 2 Pc. Rubber 40383 ----- RS 209-6 1985 Transverse 1986-1988 Radial 40396</p>	<p>SS 209-5 1982-1988 72564</p>



ENGINE INFORMATION	HEAD GASKET	HEAD KIT With <u>NO</u> Valve Stem Seals	HEAD SET With Valve Stem Seals	KIT SET	SHORT BLOCK SET
--------------------	-------------	--	--------------------------------------	---------	-----------------

GM Buick, Cad, Chev, Geo, Olds, Pont, & Saturn: V8

4.3L 260 OHV V8 Oldsmobile Engine, 16 Vlv 1975-82	HG 606-5 1975-1976 8497 ----- HG 606-2 1977-1982 8505	HK 606-5 1975-1976 Valley Pan Not in Kit 8497 ----- HK 606-2 1977-1982 Valley Pan Not in Kit 8505	HS 606-5 1975-1976 Valley Pan Not in Kit 8497 ----- HS 606-2 1977-1982 Valley Pan Not in Kit 8505	KS 606-5 1975-1976 Valley Pan Not in Kit 8497 ----- KS 606-2 1977-1982 Valley Pan Not in Kit 8505	ER 606-5 1975-1976 Valley Pan Not in Kit 8497 ----- ER 606-2 1977-1982 Valley Pan Not in Kit 8505
4.3L 262 OHV V8 Chevrolet Engine, 16 Vlv 1975-76	HG 303-6 1975-1976 8510 Head Bolts HB 303-5 1975-1976 2 Required 72856X2	HK 303-6 1975-1976 8510	HS 303-6 1975-1976 8510	KS 303-6 1975-1976 8510-1	ER 303-6 1975-1976 8510-1
4.3L 265 OHV V8 Chevrolet Engine, 16 Vlv 1955-57	HG 303-3 1955-1957 7733-2 Head Bolts HB 303-5 1955-1957 2 Required 72856X2	HK 303-3 1955-1957 7733-2	HS 303-3 1955-1957 7733-2	KS 303-3 1955-1957 Rope RS N/I 7733-2	ER 303-3 1955-1957 7733-2
4.3L 265 OHV V8 Chevrolet Engine, 16 Vlv LT-1 1994-96 VIN W 1994-1996 LT-1	HG 303-8 1994-1996 9085 ----- Head Bolts HB 303-5 1994-1996 2 Required 72856X2	HK 303-15 1994-1996 9085	HS 303-15 1994-1996 9085	KS 303-15 1994-1996 9085	ER 303-15 1994-1996 9085
4.4L 267 OHV V8 Chevrolet Engine, 16 Vlv 1979-82 VIN J 1979-1982	HG 303-6 1979-1982 8670 Head Bolts HB 303-5 1979-1982 2 Required 72856X2	HK 303-6 1979-1982 8670	HS 303-6 1979-1982 8670-1	KS 303-6 1979-1982 8670-1	ER 303-6 1979-1982 8670-1



OIL PAN SET	INTAKE MANIFOLD SET	EXHAUST MANIFOLD SET	VALVE COVER SET	TIMING COVER SET	REAR SEAL SET	VALVE STEM SEAL SET
-------------	---------------------	----------------------	-----------------	------------------	---------------	---------------------

GM Buick, Cad, Chev, Geo, Olds, Pont, & Saturn: V8

<p>OP 603-3 1975-1982 30471 13419</p>	<p>VP 603-4 1975-1976 96027 ----- VP 606-2 1977-1982 96026</p>	<p>EMS 603-3 1975-1982 90021</p>	<p>VS 605-5 1975-1982 13403</p>	<p>TCS 605-3 1975-1982 13417</p>	<p>RS 109-5 1975-1982 Rope 13044-2</p>	<p>SS 605-5 1975-1982 70393</p>
<p>OP 303-5 1975-1976 34510 ----- OP 303-7 1975-1976 LH & RH Dip Stick/ Thin & Thick Front Seals Universal Set</p>	<p>MS 303-2 1975-1976 90314-2</p>	<p>EMS 303-5 1975-1976 9275</p>	<p>VS 303-5 1975-1976 12869 ----- VS 303-5A 1975-1976 Cork 7/32" Thick 12869AC</p>	<p>TCS 303-5 1975-1976 45121</p>	<p>RS 303-5 1975-1976 2 Pc. Silicone 40013</p>	<p>SS 303-3 1975-1976 5112 O-Ring</p>
<p>OP 303-3 1955-1957 5197-2 ----- OP 303-7 1955-1957 LH & RH Dip Stick/ Thin & Thick Front Seals Universal Set</p>	<p>MS 303-1 1955-1957 9275</p>	<p>EMS 303-5 1955-1957 9275</p>	<p>VS 303-5 1955-1957 12869 ----- VS 303-5A 1955-1957 Cork 7/32" Thick 12869AC</p>	<p>TCS 303-3 1955-1957 5124-1</p>	<p>RS 303-1 1955-1957 Rope 5155</p>	<p>SS 303-3 1955-1957 5112 O-Ring</p>
<p>OP 303-9 1994-1996 34500</p>	<p>MS 303-13 1994-1996 95580</p>	<p>EMS 303-6 1994-1996 95585</p>	<p>VS 303-6 1994-1996 50088 ----- VS 303-8 1994-1998 Rubber Coated K-Cork w/Steel Core Set HD 50088</p>	<p>TCS 303-11 1994-1996 Use w/Oil Pan 45956</p>	<p>RS 303-8 1994-1996 Radial 40520</p>	<p>SS 303-10 1994-1996 72861</p>
<p>OP 303-5 1979 5197-5 ----- OP 303-7 1979 LH & RH Dip Stick/ Thin & Thick Front Seals Universal Set ----- OP 303-6 1980-1982 30410</p>	<p>MS 303-2 1979-1982 90314-2</p>	<p>EMS 303-5 1979-1982 9275</p>	<p>VS 303-5 1979-1982 12869 ----- VS 303-5A 1979-1982 Cork 7/32" Thick 12869AC</p>	<p>TCS 303-5 1979-1982 45121</p>	<p>RS 303-5 1979-1982 2 Pc. Silicone 40013</p>	<p>SS 303-3 1979-1982 5112 O-Ring ----- SS 303-6 1981-1982 Int. Seal 72527 ----- SS 303-8 1981-1982 Exhaust Seal 72526</p>



ENGINE INFORMATION	HEAD GASKET	HEAD KIT With <u>NO</u> Valve Stem Seals	HEAD SET With Valve Stem Seals	KIT SET	SHORT BLOCK SET
--------------------	-------------	--	--------------------------------------	---------	-----------------

GM Buick, Cad, Chev, Geo, Olds, Pont, & Saturn: V8

<p>4.5L 273 OHV V8 Cadillac Engine, 16 Vlv 1988-92</p> <p>VIN 3 1990 VIN 5 1988-1990 VIN 8 1989-1992</p>	<p>HG 209-5 1988-1992 8753-1</p>	<p>HK 209-2 1988-1990 Vin 5 8753-3 -----</p> <p>HK 209-4 1989-1992 Vin 3, 8 8753-4</p>	<p>HS 209-2 1988-1990 Vin 5 8753-3 -----</p> <p>HS 209-4 1989-1992 Vin 3, 8 8753-4</p>	<p>KS 209-2 1988-1990 Vin 5 8753-3 -----</p> <p>KS 209-4 1989-1992 Vin 3, 8 8753-4</p>	<p>ER 209-2 1988-1990 Vin 5 8753-3 -----</p> <p>ER 209-4 1989-1992 Vin 3, 8 8753-4</p>
<p>4.6L 281 DOHC V8 Cadillac Northstar Engine, 32 Vlv 1993-2004</p> <p>VIN A 2004-2006 (NORTHSTAR H.O.) VIN Y 1993-2006 (NORTHSTAR) VIN 9 1993-2006 (NORTHSTAR H.O.)</p>	<p>HG 212-2R 1993-2006 Right Hand 26151 -----</p> <p>HG 212-4L 1993-2006 Left Hand 26150 -----</p> <p>Head Bolt Set HB 209-5 1993-1999 72186 -----</p> <p>HB 244-4 2000-2006 72187</p>	<p>HK 212-2 1993-1994 26150 -----</p> <p>HK 212-4 1995-1999 26150-1 -----</p> <p>HK 212-6 2000-2001 26150-2</p>	<p>HS 212-2 1993-1994 26150 -----</p> <p>HS 212-4 1995-1999 26150-1 -----</p> <p>HS 212-6 2000-2001 26150-2 -----</p> <p>HS 212-8 2002-2005 26150-3</p>	<p>KS 212-2 1993-1994 26150 -----</p> <p>KS 212-4 1995-1999 26150-1 -----</p> <p>KS 212-6 2000-2001 26150-2 -----</p> <p>KS 212-8 2002-2005 26150-3</p>	<p>ER 212-2 1993-1994 26150 -----</p> <p>ER 212-4 1995-1999 26150-1 -----</p> <p>ER 212-6 2000-2001 26150-2 -----</p> <p>ER 212-8 2002-2005 26150-3</p>
<p>4.6L 283 OHV V8 Chevrolet Engine, 16 Vlv 1957-67</p>	<p>HG 303-3 1957-1967 7733-1</p> <p>Head Bolt Set HB 303-5 1957-1967 2 Required 72856X2</p>	<p>HK 303-3 1957-1967 7733-1</p>	<p>HS 303-3 1957-1967 7733-1</p>	<p>KS 303-3 1957-1967 7733-1</p>	<p>ER 303-3 1957-1967 7733-1</p>

OIL PAN SET	INTAKE MANIFOLD SET	EXHAUST MANIFOLD SET	VALVE COVER SET	TIMING COVER SET	REAR SEAL SET	VALVE STEM SEAL SET
-------------	---------------------	----------------------	-----------------	------------------	---------------	---------------------

GM Buick, Cad, Chev, Geo, Olds, Pont, & Saturn: V8

<p>OP 209-5 1988-1992 30525</p> <p>MS 209-2 1988-1990 Vin 5 Use w/VS 94116 -----</p> <p>MS 209-4 1990 Vin 3 Use w/VS 96548-1 -----</p> <p>MS 209-7 1989-1992 Vin 8 Upper & Lower Set Use w/VS 94548 -----</p> <p>MS 209-6 1989-1992 Vin 8 Upper Set 94613</p>	<p>EMS 209-4 1988-1992 94250</p>	<p>VS 209-5 1988-1990 Vin 5 w/o Grommets 50073 -----</p> <p>VS 209-4 1990 Vin 3 1989-1992 Vin 8 w/o Grommets 50074</p>	<p>TCS 209-6 1988-1992 45222-2</p>	<p>RS 209-6 1988-1992 Radial 40396</p>	<p>SS 209-5 1988-1992 72564</p>	
<p>OP 244-5 1993-2006 30704</p>	<p>MS 212-2 1993-1994 93225 -----</p> <p>MS 244-5 1995-1999 93222 -----</p> <p>MS 244-6 2000-2005 93313</p>	<p>EMS 244-5 1993-1999 93455 -----</p> <p>EMS 244-6 2000-2005 93371</p>	<p>VS 244-5 1993-1999 w/Grommets & Spark Plug Seals 50524 -----</p> <p>VS 244-6 2000-2006 w/Grommets & Spark Plug Seals 50526</p>	<p>TCS 244-2 1993-2006 Cam Frt. Seal Set 46011 -----</p> <p>TCS 244-4 1993-1997 1998 1 st. Design Crank Frt. Seal Set 46012 -----</p> <p>TCS 244-5 1998 2nd. Design 1999 Crank Frt. Seal Set 46018 -----</p> <p>TCS 244-6 2001-2005 Crank Frt. Seal Set 46013</p>	<p>RS 244-2 1993-1996 1st Design 9.0mm Thick Radial 40669 -----</p> <p>RS 244-4 1996-2006 2nd Design 12.0mm Thick Radial 40670</p>	<p>SS 212-2 1993-1999 71146X2 -----</p> <p>SS 244-4 2000-2001 71042X2 -----</p> <p>SS 212-5 2002-2006 71043X2</p>
<p>OP 303-2 1957-1967 5197-2 -----</p> <p>OP 303-7 1957-1967 LH & RH Dip Stick/ Thin & Thick Front Seals Universal Set</p>	<p>MS 303-1 1957-1967 9617</p>	<p>EMS 303-5 1957-1967 9275</p>	<p>VS 303-5 1957-1967 12869 -----</p> <p>VS 303-5A 1957-1967 Cork 7/32" Thick 12869AC</p>	<p>TCS 303-3 1957-1967 5124-1</p>	<p>RS 303-1 1957-1958 Rope 5155 -----</p> <p>RS 303-5 1959-1967 2 Pc. Silicone 40013</p>	<p>SS 303-3 1957-1967 5112 O-Ring</p>



ENGINE INFORMATION	HEAD GASKET	HEAD KIT With <u>NO</u> Valve Stem Seals	HEAD SET With Valve Stem Seals	KIT SET	SHORT BLOCK SET
--------------------	-------------	--	--------------------------------------	---------	-----------------

GM Buick, Cad, Chev, Geo, Olds, Pont, & Saturn: V8

4.9L 298 OHV V8 Cadillac Engine, 16 Vlv 1991-95 VIN B 1991-1995	HG 209-5 1991-1995 8753-1	HK 209-4 1991-1995 8753-4	HS 209-4 1991-1995 8753-4	KS 209-4 1991-1995 8753-4	ER 209-4 1991-1995 8753-4
4.9L 301 OHV V8 Pontiac Engine, 16 Vlv 1977-81 VIN W 1978-1981 VIN Y 1977-1979	HG 701-3 1977-1981 8717-2	HK 701-3 1977-1981 8719	HS 701-3 1977-1981 8719	KS 701-3 1977-1981 8532	ER 701-3 1977-1981 8532
4.9L 301 OHV Turbo V8 Pontiac Engine, 16 Vlv 1980-81 VIN T 1980-1981	HG 701-3 1980-1981 8717-2	HK 701-4 1980-1981 8717-2	HS 701-4 1980-1981 8717-2	KS 701-4 1980-1981 8717-2	ER 701-4 1980-1981 8717-2
4.9L 302 OHV V8 Chevrolet Engine, 16 Vlv 1967-69	HG 303-3 1967-1969 7733-2 Head Bolt Set HB 303-5 1967-1969 2 Required 72856X2	HK 303-3 1967-1969 7733-2	HS 303-3 1967-1969 7733-2	KS 303-3 1967-1969 7733-2	ER 303-3 1967-1969 7733-2



OIL PAN SET	INTAKE MANIFOLD SET	EXHAUST MANIFOLD SET	VALVE COVER SET	TIMING COVER SET	REAR SEAL SET	VALVE STEM SEAL SET
-------------	---------------------	----------------------	-----------------	------------------	---------------	---------------------

GM Buick, Cad, Chev, Geo, Olds, Pont, & Saturn: V8

OP 209-5 1991-1995 30525	MS 209-5 1991-1995 Use w/ VS 94548-1	EMS 209-4 1991-1995 94250	VS 209-4 1991-1995 50074	TCS 209-6 1991-1995 45522-2	RS 209-6 1991-1995 Radial 40396	SS 209-5 1991-1995 72564
OP 703-4 1977-1981 30191-2	MS 701-3 1977-1981 90364	EMS 701-3 1977-1981 90365	VS 703-5 1977-1981 50005	TCS 703-3 1977-1981 13383-3	RS 703-5 1977-1981 Rope 12173	SS 303-3 1977-1980 O-Ring 5112 ----- SS 701-5 1981 72528
OP 703-4 1980-1981 30191-2	MS 701-3 1980-1981 90364	EMS 701-3 1980-1981 90365	VS 703-5 1980-1981 50005	TCS 703-3 1980-1981 13383-3	RS 703-5 1980-1981 Rope 12173	SS 303-3 1980 O-Ring 5112 ----- SS 701-5 1981 72528
OP 303-2 1967-1969 5197-2 ----- OP 303-7 1967-1969 LH & RH Dip Stick/ Thin & Thick Front Seals Universal Set	MS 303-2 1967-1969 90314-2	EMS 303-5 1967-1969 9275	VS 303-5 1967-1969 12869 ----- VS 303-5A 1967-1969 Cork 7/32" Thick 12869AC	TCS 303-3 1967-1969 5124-1	RS 303-5 1967-1969 2 Pc. Silicone 40013	SS 303-3 1967-1969 O-Ring 5112



ENGINE INFORMATION	HEAD GASKET	HEAD KIT With <u>NO</u> Valve Stem Seals	HEAD SET With Valve Stem Seals	KIT SET	SHORT BLOCK SET
--------------------	-------------	--	--------------------------------------	---------	-----------------

GM Buick, Cad, Chev, Geo, Olds, Pont, & Saturn: V8

<p>5.0L 305 OHV V8 Chevrolet Engine, 16 Vlv 1976-93</p> <p>VIN E 1988-1993 VIN F 1985-1992 VIN G 1979 & 1984-1988 VIN H 1978-1988 VIN Q 1976 VIN S 1983 VIN U 1976-1978 VIN 7 1982-1983</p>	<p>HG 303-6 1976-1993 8510</p> <p>Head Bolt Set HB 303-5 1976-1993 2 Required 72856X2</p>	<p>HK 303-6 1976-1980 & 1981-1986 w/ 4 Bbl. Carb 8510/ -1 ----- HK 303-7 1982-1983 w/CFI 8510-2 ----- HK 303-9 1985-1986 w/TPI 8510-3 ----- HK 303-8 1987-1988 w/ 4 Bbl. Carb 1988-1993 w/TBI 8510-4 ----- HK 303-14 1987-1993 w/TPI 8510-5</p>	<p>HS 303-6 1976-1980 & 1981-1986 w/ 4 Bbl. Carb 8510/ -1 ----- HS 303-7 1982-1983 w/CFI 8510-2 ----- HS 303-9 1985-1986 w/TPI 8510-3 ----- HS 303-8 1987-1988 w/ 4 Bbl. Carb 1988-1993 w/TBI 8510-4 ----- HS 303-14 1987-1993 w/TPI 8510-5</p>	<p>KS 303-6 1976-1980 & 1981-1986 w/ 4 Bbl. Carb 8510/ -1 ----- KS 303-7 1982-1983 w/CFI 8510-2 ----- KS 303-9 1985-1986 w/TPI 8510-3 ----- KS 303-8 1987-1988 w/ 4 Bbl. Carb 1988-1993 w/TBI 8510-4 ----- KS 303-14 1987-1993 w/TPI 8510-5</p>	<p>ER 303-6 1976-1980 & 1981-1986 w/ 4 Bbl. Carb 8510/ -1 ----- ER 303-7 1982-1983 w/CFI 8510-2 ----- ER 303-9 1985-1986 w/TPI 8510-3 ----- ER 303-8 1987-1988 w/ 4 Bbl. Carb 1988-1993 w/TBI 8510-4 ----- ER 303-14 1987-1993 w/TPI 8510-5</p>
<p>5.0L 307 OHV V8 Oldsmobile Engine, 16 Vlv 1980-90</p>	<p>HG 603-7 1980-1990 8653</p>	<p>HK 603-7 1980-1984 Valley Pan N/I 8653-1 ----- HK 603-8 1985-1990 Valley Pan N/I 8653-2</p>	<p>HS 603-7 1980-1984 Valley Pan N/I 8653-1 ----- HK 603-8 1985-1990 Valley Pan N/I 8653-2</p>	<p>KS 603-7 1980-1984 Valley Pan N/I 8653-1 ----- HK 603-8 1985-1990 Valley Pan N/I 8653-2</p>	<p>ER 603-7 1980-1984 Valley Pan N/I 8653-1 ----- HK 603-8 1985-1990 Valley Pan N/I 8653-2</p>
<p>5.0L 307 OHV V8 Chevrolet Engine, 16 Vlv 1968-73</p> <p>VIN F 1972-1973</p>	<p>HG 303-3 1972-1973 7733-2</p> <p>Head Bolt Set HB 303-5 1972-1973 2 Required 72856X2</p>	<p>HK 303-3 1972-1973 7733-2</p>	<p>HS 303-3 1972-1973 7733-2</p>	<p>KS 303-3 1972-1973 7733-2</p>	<p>ER 303-3 1972-1973 7733-2</p>
<p>5.3L 327 OHV V8 Chevrolet Engine, 16 Vlv 1962-69</p>	<p>HG 303-3 1962-1969 7733-2</p> <p>Head Bolt Set HB 303-5 1962-1969 2 Required 72856X2</p>	<p>HK 303-3 1962-1969 7733-2</p>	<p>HS 303-3 1962-1969 7733-2</p>	<p>KS 303-3 1962-1969 7733-2</p>	<p>ER 303-3 1962-1969 7733-2</p>

OIL PAN SET	INTAKE MANIFOLD SET	EXHAUST MANIFOLD SET	VALVE COVER SET	TIMING COVER SET	REAR SEAL SET	VALVE STEM SEAL SET
-------------	---------------------	----------------------	-----------------	------------------	---------------	---------------------

GM Buick, Cad, Chev, Geo, Olds, Pont, & Saturn: V8

<p>OP 303-5 1976-1979 5197-5 -----</p> <p>OP 303-7 1976-1979 LH & RH Dip Stick/ Thin & Thick Front Seals Universal Set -----</p> <p>OP 303-10 1980-1985 1 Pc Silicone 30410 -----</p> <p>OP 303-9 1986-1993 1 Pc. Silicone 34500</p>	<p>MS 303-2 1976-1986 2 & 4 Bbl Carb 90314-2 -----</p> <p>MS 303-4 1982-1983 w/CFI Upper & Lower 91440 -----</p> <p>MS 303-6 1985-1992 w/TPI Upper & Lower 93035-1 -----</p> <p>MS 303-7 1987-1988 w/4 Bbl. Carb 1988-1993 w/TBI 93317</p>	<p>EMS 303-5 1976-1993 9275</p>	<p>VS 303-5 1976-1986 12869 -----</p> <p>VS 303-5A 1976-1986 Cork 7/32" Thick 12869AC -----</p> <p>VS 303-7 1976-1986 Hi-Temp 50265 -----</p> <p>VS 303-6 1987-1993 Flat Silicone 50088 -----</p> <p>VS 303-8 1987-1993 Rubber Coated K-Cork w/Steel Core Set HD 50088</p>	<p>TCS 303-5 1976-1993 45121</p>	<p>RS 303-5 1976-1985 2 Pc. Silicone 40013 -----</p> <p>RS 303-8 1986-1993 Radial 40520 -----</p> <p>RS 303-9 1986-1993 Radial PTFE 40626</p>	<p>SS 303-3 1976-1980 1987-1989 Exh. 5112 O-Ring -----</p> <p>SS 303-6 1981-1993 Intake 72527 -----</p> <p>SS 303-8 1981-1986 1990-1993 Exhaust 70526</p>
<p>OP 603-3 1980-1990 13419</p>	<p>VP 603-4 1980-1984 96027 -----</p> <p>VP 603-7 1985-1990 96039</p>	<p>EMS 603-3 1980-1990 90021</p>	<p>VS 605-5 1980-1990 13403</p>	<p>TCS 605-3 1980-1990 13417</p>	<p>RS 109-5 1980-1990 Rope 13044-2 -----</p> <p>RS 512-5 2 Pc Rubber 40032</p>	<p>SS 605-5 1980-1990 70393</p>
<p>OP 303-2 1968-1973 5197-2 -----</p> <p>OP 303-7 1968-1973 LH & RH Dip Stick/ Thin & Thick Front Seals Universal Set</p>	<p>MS 303-1 1968 9617 -----</p> <p>MS 303-2 1969-1973 90314-2</p>	<p>EMS 303-5 1968-1973 9275</p>	<p>VS 303-5 1968-1973 12869 -----</p> <p>VS 303-5A 1968-1973 Cork 7/32" Thick 12869AC</p>	<p>TCS 303-3 1968-1973 5124-1</p>	<p>RS 303-5 1968-1973 2 Pc. Silicone 40013</p>	<p>SS 303-3 1968-1973 O-Ring 5112</p>
<p>OP 303-2 1962-1969 5197-2 -----</p> <p>OP 303-7 1962-1969 LH & RH Dip Stick/ Thin & Thick Front Seals Universal Set</p>	<p>MS 303-1 1962-1968 9617 -----</p> <p>MS 303-2 1969 90314-2</p>	<p>EMS 303-5 1962-1969 9275</p>	<p>VS 303-5 1962-1969 12869 -----</p> <p>VS 303-5A 1962-1969 Cork 7/32" Thick 12869AC</p>	<p>TCS 303-3 1962-1969 5124-1</p>	<p>RS 303-5 1962-1969 2 Pc. Silicone 40013</p>	<p>SS 303-3 1962-1969 O-Ring 5112</p>



ENGINE INFORMATION	HEAD GASKET	HEAD KIT With <u>NO</u> Valve Stem Seals	HEAD SET With Valve Stem Seals	KIT SET	SHORT BLOCK SET
--------------------	-------------	--	--------------------------------------	---------	-----------------

GM Buick, Cad, Chev, Geo, Olds, Pont, & Saturn: V8

5.3L 327 OHV V8 Chevrolet Engine, 16 Vlv 2005-2008 VIN C 2005-2008	HG 320-5 2005-2008 26190 Head Bolts HB 320-3 2005-2008 7220				
5.4L 330 OHV V8 Oldsmobile Engine, 16 Vlv 1964-67	HG 603-3 1964-1967 8171-1	HK 603-3 1964-1967 Valley Pan N/I 8171-4	HS 603-3 1964-1967 Valley Pan N/I 8171-4	KS 603-3 1964-1967 Valley Pan N/I 8171-4	ER 603-3 1964-1967 Valley Pan N/I 8171-4
5.7L 346 OHV V8 Chevrolet LS-1, LS-6 Engine 1997-2005 VIN G 1997-2004 (LS-1) VIN S 2001-2005 (LS-6)	HG 320-4 1997-2001 9284 ----- HG 320-6 2002-2004 26190 HEAD BOLTS HB 320-1 1997-2004 1 St. Design 2 Required 72173 ----- HB 320-3 2004-2005 2nd Design 2 Required 72220	HK 320-12 1997-1998 9284 ----- HK 320-14 1999-2000 & 2001 Camaro & Firebird 9284-1 ----- HK 320-15 2001 Corvette 9284-2 ----- HK 320-16 2002 Camaro & Firebird 26190-1 ----- HK 320-18 2002-2004 Corvette 26190	HS 320-12 1997-1998 9284 ----- HS 320-14 1999-2000 & 2001 Camaro & Firebird 9284-1 ----- HS 320-15 2001 Corvette 9284-2 ----- HS 320-16 2002 Camaro & Firebird 26190-1 ----- HS 320-18 2002-2004 Corvette 26190	KS 320-12 1997-1998 9284 ----- KS 320-14 1999-2000 & 2001 Camaro & Firebird 9284-1 ----- KS 320-15 2001 Corvette 9284-2 ----- KS 320-16 2002 Camaro & Firebird 26190-1 ----- KS 320-18 2002-2004 Corvette 26190	ER 320-12 1997-1998 9284 ----- ER 320-14 1999-2000 & 2001 Camaro & Firebird 9284-1 ----- ER 320-15 2001 Corvette 9284-2 ----- ER 320-16 2002 Camaro & Firebird 26190-1 ----- ER 320-18 2002-2004 Corvette 26190
5.7L 350 OHV V8 Buick Engine, 16 Vlv 1968-81 VIN B 1981 VIN H 1972-1977 VIN J 1972-1977 VIN K 1972 VIN X 1978-1980	HG 106-5 1968-1981 8264-1	HK 106-5 1968-1981 Valley Pan N/I 8264-1	HS 106-5 1968-1981 Valley Pan N/I 8264-1	KS 106-5 1968-1981 Valley Pan N/I 8264-1	ER 106-5 1968-1981 Valley Pan N/I 8264-1



OIL PAN SET	INTAKE MANIFOLD SET	EXHAUST MANIFOLD SET	VALVE COVER SET	TIMING COVER SET	REAR SEAL SET	VALVE STEM SEAL SET
-------------	---------------------	----------------------	-----------------	------------------	---------------	---------------------

GM Buick, Cad, Chev, Geo, Olds, Pont, & Saturn: V8

OP 320-1 2005-2008 30693	MS 320-4 2005-2008 SUPER DUTY PTFE 96587	EMS 320-2 2005-2008 92467	VS 320-4 2005-2008 50504		RS 320-1 2005-2008 PTFE 40640	SS 320-4 2005-2008 71039
OP 603-3 1964-1967 13419	MS 603-3 1964-1967 2 pc Design 9947-1 ----- VP 603-3 1967 Serial Prefix 4W, 8W 96009	EMS 603-3 1964-1967 90021	VS 605-5 1964-1967 13403	TCS 605-3 1964-1967 13417	RS 109-5 1964-1967 Rope 13044-2 ----- RS 512-5 2 Pc Rubber 40032	SS 605-5 1964-1967 70393
OP 320-1 1997-2000 All 2001-2002 Camaro & Firebird 2001-2004 Corvette Upper 2004-2005 CTS 30693 ----- OP 320-3 2001-2004 Corvette Lower 30703	MS 320-5 1997-2005 92438 ----- THROTTLE BODY TB 320-5 1997-2005 61069	EMS 320-2 1997-2000 & 2001-2002 Camaro & Firebird & 2004-2005 CTS Model 92467 ----- EMS 320-4 2001-2004 Corvette 92904	VS 320-2 1997-1998 50503 ----- VS 320-4 1999-2005 50504	TCS 320-5 1997-2004 Use w/ OP 45993	RS 320-1 1997-2004 Radial PTFE 40640	SS 320-1 1997-2001 .492 O.D. Guide Positive seal 70945 ----- SS 320-4 2002-2005 .715 O.D. Guide Top Hat Design 71039
OP 106-5 1968-1981 13397-1	VP 106-5 1968-1981 96006	EMS 106-5 1968-1981 90241	VS 106-5 1968-1981 50034	TCS 106-5 1968-1981 Rope Seal 45006 ----- TCS 109-6 1968-1981 Rubber Radial 45930	RS 109-5 1968-1981 Rope Seal 13044-2	SS 106-5 1968-1981 70092-1 X2



ENGINE INFORMATION	HEAD GASKET	HEAD KIT With <u>NO</u> Valve Stem Seals	HEAD SET With Valve Stem Seals	KIT SET	SHORT BLOCK SET
--------------------	-------------	--	--------------------------------------	---------	-----------------

GM Buick, Cad, Chev, Geo, Olds, Pont, & Saturn: V8

5.7L 350 OHV V8 Pontiac Engine, 16 Vlv 1968-77	HG 703-4 1968-1977 8518	HK 703-4 1968-1971 8518 -----	HS 703-4 1968-1971 8518 -----	KS 703-4 1968-1971 8518 -----	ER 703-4 1968-1971 8518 -----
VIN A 1974 VIN B 1974 VIN E 1975 VIN K 1974-1975 VIN M 1972-1976 VIN N 1972-1975 VIN P 1976-1977 VIN V 1976		HK 703-5 1972-1977 8518	HS 703-5 1972-1977 8518	KS 703-5 1972-1977 8518	ER 703-5 1972-1977 8518



OIL PAN SET	INTAKE MANIFOLD SET	EXHAUST MANIFOLD SET	VALVE COVER SET	TIMING COVER SET	REAR SEAL SET	VALVE STEM SEAL SET
-------------	---------------------	----------------------	-----------------	------------------	---------------	---------------------

GM Buick, Cad, Chev, Geo, Olds, Pont, & Saturn: V8

OP 703-3 1968-1976 1st Design 3 Hole Rear OP Flange 30191-3 ----- OP 703-4 1976-1977 2nd Design 5 Hole Rear OP Flange 30191-2	MS 703-3 1968-1971 9980 ----- MS 703-5 1971-1977 90205	EMS 703-3 1968-1977 9499	VS 703-5 1968-1977 50005	TCS 703-3 1968-1977 13383-3	RS 703-5 1968-1977 Rope Seal 12173	SS 303-3 1968-1977 O-Ring 5112 ----- SS 703-5 1968-1976 Guide Seal 13360
---	--	--------------------------------	--------------------------------	-----------------------------------	---	--



ENGINE INFORMATION	HEAD GASKET	HEAD KIT With <u>NO</u> Valve Stem Seals	HEAD SET With Valve Stem Seals	KIT SET	SHORT BLOCK SET
--------------------	-------------	--	--------------------------------------	---------	-----------------

GM Buick, Cad, Chev, Geo, Olds, Pont, & Saturn: V8

5.7L 350 OHV V8 Chevrolet Engine, 16 Vlv 1967-91 CORVETTE MODEL ONLY Exc. LT ENG. VIN H 1978 VIN L 1976-1979 VIN T 1973-1975 VIN X 1976-1977 VIN 4 1979 VIN 5 1996 VIN 6 1980-1981 VIN 8 1982-1991	HG 303-2 1967-1976 Embossed Steel Shim .020 7733-1 ----- HG 303-3 1967-1993 7733-2 ----- HG 303-7 1967-1976 Embossed Copper Shim .020 ----- HG 303-10 1987-1993 Graphite/ Stainless H D Head Bolt Set HB 303-5 1967-1993 2 Required 72856X2	HK 303-3 1967-1980 7733-2 ----- HK 303-5 1981 & 1986 Corvette, w/CI Heads Int N/I 7733-3 ----- HK 303-11 1982 & 1984 Corvette W/CPI 7733-4 ----- HK 303-10 1985 Corvette 7733-6 ----- HK 303-16 1986-1991 Corvette w/Aluminum Heads, TPI 7733-9 ----- HK 303-13 1987-88 w/4 Bbl Carb Int N/I 1989-1993 w/TPI 7733-15	HS 303-3 1967-1980 7733-2 ----- HS 303-5 1981 1986 Corvette, w/CI Heads Int N/I 7733-3 ----- HS 303-11 1982 & 1984 Corvette W/CPI 7733-4 ----- HS 303-10 1985 Corvette 7733-6 ----- HS 303-16 1986-1991 Corvette w/Aluminum Heads, TPI 7733-9 ----- HS 303-13 1987-88 w/4 Bbl Carb Int N/I 1989-1993 w/TPI 7733-15	KS 303-3 1967-1980 7733-2 ----- KS 303-5 1981 1986 Corvette, w/CI Heads Int N/I 7733-3 ----- KS 303-11 1982 & 1984 Corvette W/CPI 7733-4 ----- KS 303-10 1985 Corvette 7733-6 ----- KS 303-16 1986-1991 Corvette w/Aluminum Heads, TPI 7733-9	ER 303-3 1967-1980 7733-2 ----- ER 303-5 1981 1986 Corvette, w/CI Heads Int N/I 7733-3 ----- ER 303-11 1982 & 1984 Corvette W/CPI 7733-4 ----- ER 303-10 1985 Corvette 7733-6 ----- ER 303-16 1986-1991 Corvette w/Aluminum Heads, TPI 7733-9
--	--	---	---	--	--

OIL PAN SET	INTAKE MANIFOLD SET	EXHAUST MANIFOLD SET	VALVE COVER SET	TIMING COVER SET	REAR SEAL SET	VALVE STEM SEAL SET
-------------	---------------------	----------------------	-----------------	------------------	---------------	---------------------

GM Buick, Cad, Chev, Geo, Olds, Pont, & Saturn: V8

<p>OP 303-2 1967-1974 5197-2 -----</p> <p>OP 303-5 1975-1979 5197-5 -----</p> <p>OP 303-7 1967-1979 LH & RH Dip Stick/ Thin & Thick Front Seals Universal Set -----</p> <p>OP 303-10 1975-1985 1 Pc. Silicone 34510 -----</p> <p>OP 303-9 1986-1993 1 Pc. Silicone 34500</p>	<p>MS 303-1 1967-1968 9617 -----</p> <p>MS 303-2 1969-1973 74 w/2 Bbl. 1975-1981 1987-1988 4 Bbl Carb 90314-2 -----</p> <p>MS 303-5 1974 w/ 4 Bbl 90314-3 -----</p> <p>MS 303-4 1982 & 1984 Corvette w/CFI Upper & Lower Set 91440 -----</p> <p>MS 303-6 1985 Corvette w/TPI Upper & Lower Set 93035-1 -----</p> <p>MS 303-9 1986 Corvette w/TPI w/Cast Iron Hds. 93316 -----</p> <p>MS 303-10 1986-1991 Corvette w/TPI w/Aluminum Hds TPI Upper & Lower Set 93318 -----</p> <p>MS 303-7 1989-1993 w/TPI 93317 -----</p> <p>MS 303-8 1985-1992 Upper Set w/TPI 93160</p>	<p>EMS 303-5 1967-1981 9275 -----</p> <p>EMS 303-8 1982-1991 Corvette 94054</p>	<p>VS 303-5 1967-1986 12869 -----</p> <p>VS 303-5A 1967-1988 Cork 7/32" Thick 12869AC -----</p> <p>VS 303-7 1967-1986 Hi-Temp 50265 -----</p> <p>VS 303-6 1987-1993 Flat Silicone 50088 -----</p> <p>VS 303-8 1987-1993 Rubber Coated K-Cork w/Steel Core Set HD 50088</p>	<p>TCS 303-3 1967-1974 5124-1 -----</p> <p>TCS 303-5 1975-1993 Use w/OP on 1986-1993 45121</p>	<p>RS 303-5 1967-1985 2 Pc Silicone 40013 -----</p> <p>RS 303-8 1986-1993 Radial 40520 -----</p> <p>RS 303-9 1986-1993 Radial PTFE 40626</p>	<p>SS 303-3 1967-1989 O-RING 5112 -----</p> <p>SS 303-6 1981-1993 Int Seal Set 72527 -----</p> <p>SS 303-8 1981-1993 Exh Seal Set 72526</p>
--	--	---	--	--	--	---



OIL PAN SET	INTAKE MANIFOLD SET	EXHAUST MANIFOLD SET	VALVE COVER SET	TIMING COVER SET	REAR SEAL SET	VALVE STEM SEAL SET
-------------	---------------------	----------------------	-----------------	------------------	---------------	---------------------

GM Buick, Cad, Chev, Geo, Olds, Pont, & Saturn: V8

<p>OP 303-2 1967-1974 5197-2 -----</p> <p>OP 303-5 1975-1979 5197-5 -----</p> <p>OP 303-7 1967-1979 LH & RH Dip Stick/ Thin & Thick Front Seals Universal Set -----</p> <p>OP 303-10 1975-1985 1 Pc. Silicone 34510 -----</p> <p>OP 303-9 1986-1993 1 Pc. Silicone 34500</p>	<p>MS 303-1 1967-1968 9617 -----</p> <p>MS 303-2 1969-1973 1974 w/2 Bbl. 1975-1986 1987-1988 w/4 Bbl Carb 90314-2 -----</p> <p>MS 303-5 1974 w/ 4 Bbl 90314-3 -----</p> <p>MS 303-6 1987-1992 Camaro & Firebird w/TPI Upper & Lower Set 93035-1 -----</p> <p>MS 303-7 1989-1993 w/TPI 93317 -----</p> <p>MS 303-8 1985-1992 Upper Set w/TPI 93160</p>	<p>EMS 303-5 1967-1993 9275</p> <p>EMS 303-7 1992-1996 Corvette 95573-1</p>	<p>VS 303-5 1967-1986 12869 -----</p> <p>VS 303-5A 1967-1988 Cork 7/32" Thick 12869AC -----</p> <p>VS 303-7 1967-1986 Hi-Temp 50265 -----</p> <p>VS 303-6 1987-1993 Flat Silicone 50088 -----</p> <p>VS 303-8 1987-1993 Rubber Coated K-Cork w/Steel Core Set HD 50088</p> <p>VS 303-6 Exc. Corvette 1993-1997 50088 -----</p> <p>VS 303-8 1993-1997 Rubber Coated K-Cork w/Steel Core Set HD 50088 -----</p> <p>VS 303-9 Corvette 1992-1996 50443</p>	<p>TCS 303-3 1967-1974 5124-1 -----</p> <p>TCS 303-5 1975-1993 Use w/OP on 1986-1993 45121</p> <p>TCS 303-9 1992-1993 ALL 1994 Corvette Camaro Firebird USE W/OP 45953 -----</p> <p>TCS 303-11 1994 Exc. Corvette Camaro Firebird & 1995-1997 All Use w/ OP 45956</p>	<p>RS 303-5 1967-1985 2 Pc Silicone 40013 -----</p> <p>RS 303-8 1986-1993 Radial 40520 -----</p> <p>RS 303-9 1986-1993 Radial PTFE 40626</p> <p>RS 303-8 Radial 1992-1997 40520 -----</p> <p>RS 303-9 Radial PTFE 1992-1997 40626</p>	<p>SS 303-3 1967-1989 O-RING 5112 -----</p> <p>SS 303-6 1981-1993 Int Seal Set 72527 -----</p> <p>SS 303-8 1981-1993 Exh Seal Set 72526</p> <p>SS 303-10 1992-1997 72861</p>
--	---	---	--	---	---	--



ENGINE INFORMATION	HEAD GASKET	HEAD KIT With <u>NO</u> Valve Stem Seals	HEAD SET With Valve Stem Seals	KIT SET	SHORT BLOCK SET
--------------------	-------------	--	--------------------------------------	---------	-----------------

GM Buick, Cad, Chev, Geo, Olds, Pont, & Saturn: V8

5.7L 350 OHV Diesel V8 Oldsmobile Engine, 16 Vlv 1978-85	HG 608-2 1978-1985 8983 ----- HG 608-4 1978-1985 .010 Thicker 8716-1	HKX 608-2 1978-1981 w/External EGR 1 Stud Air Cleaner Head Gaskets Not In Kit 8716 ----- HKX 608-5 1981-1985 w/Internal EGR 2 Stud Air Cleaner Head Gaskets Not In Kit 8716-2	HSX 608-2 1978-1981 w/External EGR 1 Stud Air Cleaner Head Gaskets Not In Kit 8716 ----- HSX 608-5 1981-1985 w/Internal EGR 2 Stud Air Cleaner Head Gaskets Not In Kit 8716-2	KSX 608-2 1978-1981 w/External EGR 1 Stud Air Cleaner Head Gaskets Not In Kit 8716 ----- KSX 608-5 1981-1985 w/Internal EGR 2 Stud Air Cleaner Head Gaskets Not In Kit 8716-2	ERX 608-2 1978-1981 w/External EGR 1 Stud Air Cleaner Head Gaskets Not In Kit 8716 ----- ERX 608-5 1981-1985 w/Internal EGR 2 Stud Air Cleaner Head Gaskets Not In Kit 8716-2
5.7L 350 OHV V8 Oldsmobile Engine, 16 Vlv 1968-80 VIN R 1968-1980	HG 603-3 1968-1976 8171-1 ----- HG 602-5 1977-1980 8506	HK 603-3 1968-1976 Valley Pan N/I 8171-1 ----- HK 602-5 1977-1980 Valley Pan N/I 8506	HS 603-3 1968-1976 Valley Pan N/I 8171-1 ----- HS 602-5 1977-1980 Valley Pan N/I 8506	KS 603-3 1968-1976 Valley Pan N/I 8171-1 ----- KS 602-5 1977-1980 Valley Pan N/I 8506	ER 603-3 1968-1976 Valley Pan N/I 8171-1 ----- ER 602-5 1977-1980 Valley Pan N/I 8506
6.0L 364 OHV V8 Corvette GTO, CTS Engine, 16 Vlv 2005-2007 VIN H 2005-2007 (VORTEC) LS2 VIN U 2005-2007(VORTEC) LS2	HG 320-7 2005-2007 26192 HEAD BOLT SET HB 320-3 2005-2007 72220	HK	HS	KS	ER
6.0L 368 OHV V8 Cadillac Engine, 16 Vlv 1980-84	HG 205-5 1980-1984 8715	HK 205-5 1980-1984 Valley Pan N/I 8715	HS 205-5 1980-1984 Valley Pan N/I 8715	KS 205-5 1980-1984 Valley Pan N/I 8715	ER 205-5 1980-1984 Valley Pan N/I 8715

OIL PAN SET	INTAKE MANIFOLD SET	EXHAUST MANIFOLD SET	VALVE COVER SET	TIMING COVER SET	REAR SEAL SET	VALVE STEM SEAL SET
-------------	---------------------	----------------------	-----------------	------------------	---------------	---------------------

GM Buick, Cad, Chev, Geo, Olds, Pont, & Saturn: V8

OP 605-5 1978-1985 K-Cork 30471	MS 608-2 1978-1981 w/External EGR 1 Stud Air Cleaner 9947-2 ----- MS 608-4 1981-1985 w/Internal EGR 2 Stud Air Cleaner 92328	EMS 603-3 1978-1985 90021	VS 605-5 1978-1985 13403	TCS 605-3 1978-1985 13417	RS 109-5 1978-1985 Rope 13044-2 ----- RS 512-5 1978-1985 2 Pc Rubber 40032	SS 605-5 1978-1985 70393
OP 603-3 1968-1980 13419	VP 603-3 1968-1972 96009 ----- VP 603-4 1973-1982 96027	EMS 603-3 1968-1980 90021	VS 605-5 1968-1980 13403	TCS 605-3 1968-1980 13417	RS 109-5 1968-1980 Rope 13044-2 ----- RS 512-5 1968-1980 2 Pc Rubber 40032	SS 605-5 1968-1980 70393
OP 320-1 2005-2007 30693	MS 320-5 2005-2007 96718	EMS 320-2 2005-2007 92467	VS 320-4 2005-2007 50504 GROMMET SET VCG 320-5 2005-2007 72233	TCS 320-3 2005-2007 45993	RS 320-1 2005-2007 PTFE 40640	SS 320-4 2005-2007 .715 GUIDE Top Hat Design 71039
OP 203-3 1980-1984 Steel Oil Pan 30202 ----- Plastic Oil Pan Use RTV	VP 205-5 1980-1984 96036	EMS 205-5 1980-1984 90866	VS 203-3 1980-1984 Exc. 4-6-8 Eng. 50192 ----- VS 205-6 1980-1984 4-6-8 Eng. 50192-1	TCS 203-5 1980-1984 45011	RS 203-5 1980-1984 40012	SS 203-5 1980-1984 70861



ENGINE INFORMATION	HEAD GASKET	HEAD KIT With <u>NO</u> Valve Stem Seals	HEAD SET With Valve Stem Seals	KIT SET	SHORT BLOCK SET
--------------------	-------------	--	--------------------------------------	---------	-----------------

GM Buick, Cad, Chev, Geo, Olds, Pont, & Saturn: V8

6.4L 389 OHV V8 Pontiac Engine, 16 Vlv 1959-66	HG 703-3 1959-1966 8518	HK N/A	HS N/A	KS N/A	ER N/A
6.5L 396 OHV V8 GEN IV Chevrolet Engine, 16 Vlv 1965-69	HG 309-3 1965-1969 8180-2	HK 309-3 1965-1969 8180-5	HS 309-3 1965-1969 8180-5	KS 309-3 1965-1969 8180-5	ER 309-3 1965-1969 8180-5
6.5L 396 OHV V8 GEN IV Chevrolet Engine, 16 Vlv 1965-69 SPECIAL HIGH PERFORMANCE	HG 309-3 1965-1969 8180-2	HK 309-8 1965-1969 Rectangular Intake Man. Header Gaskets	HS 309-8 1965-1969 Rectangular Intake Man. Header Gaskets	KS 309-8 1965-1969 Rectangular Intake Man. Header Gaskets	ER 309-8 1965-1969 Rectangular Intake Man. Header Gaskets
6.6L 400 OHV V8 Oldsmobile Engine, 16 Vlv 1968-69	HG 603-3 1968-1969 8171-1	HK 603-3 1968-1969 Valley Pan N/I 8171-4	HS 603-3 1968-1969 Valley Pan N/I 8171-4	KS 603-3 1968-1969 Valley Pan N/I 8171-4	ER 603-3 1968-1969 Valley Pan N/I 8171-4
6.6L 400 OHV V8 Buick Engine, 16 Vlv 1967-69	HG 107-5 1967-1969 8494	HK 107-5 1967-1969 Valley Pan N/I 8494	HS 107-5 1967-1969 Valley Pan N/I 8494	KS 107-5 1967-1969 Valley Pan N/I 8494	ER 107-5 1967-1969 Valley Pan N/I 8494
6.6L 400 OHV V8 Pontiac Engine, 16 Vlv 1967-79 VIN N 1976 VIN P 1972-1974 VIN R 1972-1975 VIN S 1972-1976 VIN T 1972-1974 VIN X 1967 VIN Y 1967 VIN Z 1976-1979	HG 703-3 1967-1969 8518	HK 703-3 1967-1969 Exc. Ram Air 8518	HS 703-3 1967-1969 Exc. Ram Air 8518	KS 703-3 1967-1969 Exc. Ram Air 8518	ER 703-3 1967-1969 Exc. Ram Air 8518

OIL PAN SET	INTAKE MANIFOLD SET	EXHAUST MANIFOLD SET	VALVE COVER SET	TIMING COVER SET	REAR SEAL SET	VALVE STEM SEAL SET
-------------	---------------------	----------------------	-----------------	------------------	---------------	---------------------

GM Buick, Cad, Chev, Geo, Olds, Pont, & Saturn: V8

OP 703-3 1959-1966 30191-3	MS 703-2 1961-1964 9678-1 ----- MS 703-3 1965-1966 9980	EMS 703-3 1959-1966 9499	VS 703-5 1959-1966 50005 ----- Push Rod Cover PS 703-2 1959-1964 11488 ----- PS 703-3 1965-1966 13832	TCS 703-2 1959-1962 4 Stud Water Pump 12861-1 ----- TCS 703-3 1963-1966 8 Stud Water Pump 13383-3	RS 703-5 1959-1966 Rope 12173	SS 303-3 1959-1966 O-Ring 5112
OP 309-3 1965-1969 30061-1	MS 309-2 1965-1969 90240-2	EMS 309-3 1965-1969 90206	VS 309-3 1965-1969 30061-1	TCS 309-5 1965-1969 45060	RS 309-5 1965-1969 40096-1	SS 309-5 1965-1969 71152
OP 309-3 1965-1969 30061-1	MS 309-8 1965-1969 Special Hi-Perf Rectangular Intake Man 90005	EMS 309-5 1965-1969 Special Hi-Perf Header Gaskets 90502	VS 309-5 1965-1969 Special Hi-Perf 5/16" C/R	TCS 309-5 1965-1969 45060	RS 309-5 1965-1969 40096-1	SS 309-8 1965-1969 Double Spring 72513
OP 603-3 1968-1969 13419	VP 603-3 1968-1969 96004	EMS 603-5 1968-1969 90078	VS 605-5 1968-1969 13403	TCS 605-3 1968-1969 13417	RS 109-5 1968-1969 Rope 13044-2 ----- RS 512-5 1968-1969 2 Pc Rubber 40032	SS 605-5 1968-1969 70393
OP 107-5 1967-1969 30185	VP 107-5 1967-1969 96005	EMS 107-5 1967-1969 90539	VS 107-5 1967-1969 50004	TCS 107-5 1967-1969 45002	RS 109-5 1968-1969 Rope 13044-2	SS 107-5 1967-1969 70092-1
OP 703-3 1967-1976 1 St. Design 3 Pin Rear Pan Seal 30191-3 ----- OP 703-4 1976-1979 2nd Design 5 Slot Rear Pan Seal 30191-2	MS 703-3 1967-1971 9980 ----- MS 703-5 1972-1979 90205	EMS 703-3 1967-1979 9499	VS 703-5 1967-1979 50005	TCS 703-3 1967-1979 13383-3	RS 109-5 1967-1979 Rope 13044-2	SS 303-3 1967-1979 O-Ring 5112 ----- SS 703-5 1967-1979 Positive Seal 13360



ENGINE INFORMATION	HEAD GASKET	HEAD KIT With <u>NO</u> Valve Stem Seals	HEAD SET With Valve Stem Seals	KIT SET	SHORT BLOCK SET
--------------------	-------------	--	--------------------------------------	---------	-----------------

GM Buick, Cad, Chev, Geo, Olds, Pont, & Saturn: V8

6.6L 400 OHV V8 Chevrolet Engine, 16 Vlv 1970-76	HG 303-4 1970-1976 8364 Head Bolt Set HB 303-5 1970-1976 2 Required 72856X2	HK 303-4 1970-1976 8364-3	HS 303-4 1970-1976 8364-3	KS 303-4 1970-1976 8364-3	ER 303-4 1970-1976 8364-3
6.6L 402 OHV V8 GEN IV Chevrolet Engine, 16 Vlv 1970-72	HG 309-3 1970-1972 8180-2	HK 309-3 1970-1972 Exc, Special High Perf. 8180-5	HS 309-3 1970-1972 Exc, Special High Perf. 8180-5	KS 309-3 1970-1972 Exc, Special High Perf. 8180-5	ER 309-3 1970-1972 Exc, Special High Perf. 8180-5
6.6L 403 OHV V8 Oldsmobile Engine, 16 Vlv 1977-79	HG 603-6 1977-1979 8507	HK 603-6 1977-1979 Valley Pan N/I 8507	HS 603-6 1977-1979 Valley Pan N/I 8507	KS 603-6 1977-1979 Valley Pan N/I 8507	ER 603-6 1977-1979 Valley Pan N/I 8507
6.9L 421 OHV V8 Pontiac Engine, 16 Vlv 1961-66	HG 703-3 1961-1966 8518	HK N/A	HS N/A	KS N/A	ER N/A
7.0L 425 OHV V8 Cadillac Engine, 16 Vlv 1977-79	HG 204-5 1977-1979 8540	HK 204-5 1977-1979 8540	HS 204-5 1977-1979 8540	KS 204-5 1977-1979 8540	ER 204-5 1977-1979 8540
7.0L 425 OHV V8 Oldsmobile Engine, 16 Vlv 1965-67	HG 603-3 1965-1967 8171-1	HK 603-3 1965-1967 8171-4	HS 603-3 1965-1967 8171-4	KS 603-3 1965-1967 8171-4	ER 603-3 1965-1967 8171-4

OIL PAN SET	INTAKE MANIFOLD SET	EXHAUST MANIFOLD SET	VALVE COVER SET	TIMING COVER SET	REAR SEAL SET	VALVE STEM SEAL SET
-------------	---------------------	----------------------	-----------------	------------------	---------------	---------------------

GM Buick, Cad, Chev, Geo, Olds, Pont, & Saturn: V8

OP 303-2 1970-1974 5197-2 ----- OP 303-5 1975-1976 5197-5	MS 303-2 1970-1976 Exc 74 4 Bbl. 90314-2 ----- MS 303-5 1974 4 Bbl Carb 90314-3	EMS 303-5 1970-1976 9275	VS 303-5 1970-1976 Cork 1/8" Thick 12869 ----- VS 303-5A 1970-1976 Cork 7/32" Thick 12869AC	TCS 303-3 1970-1974 5124-1 ----- TCS 303-5 1975-1976 45121	RS 303-5 1970-1976 2 Pc. Silicone 40013	SS 303-3 1970-1976 O-Ring 5112 ----- SS 303-4 1970-1976 Opt Umbrella Use w/ O-Ring 10058
OP 309-3 1970-1972 30061-1	MS 309-2 1970-1972 90240-2 ----- MS 309-8 1970-1972 Special Hi-Perf Rectangular Intake Man 90005	EMS 309-3 1970-1972 90206 ----- EMS 309-5 1970-1972 Special Hi-Perf Header Gaskets 90502	VS 309-3 1970-1972 30055 ----- VS 309-5 1970-1972 Special Hi-Perf 5/16" C/R	TCS 309-3 1970-1972 45060	RS 309-5 1970-1972 40096-1	SS 309-5 1970-1972 71152
OP 603-3 1977-1979 13419	VP 603-4 1977-1979 96027	EMS 603-3 1977-1979 90021	VS 605-5 1977-1979 13403	TCS 605-3 1977-1979 13417	RS 109-5 1977-1979 Rope 13044-2 ----- RS 512-5 1977-1979 Rubber 40032	SS 605-5 1977-1979 70393
OP 703-3 1961-1966 30191-3	MS 703-2 1961-1964 9678-1 ----- MS 703-3 1965-1966 9980	EMS 703-3 1961-1966 9499	VS 703-5 1961-1966 50005	TCS 703-3 1961-1966 13383-3	RS 109-5 1961-1966 Rope 13044-2	SS 303-3 1961-1966 O-Ring 5112 ----- SS 703-5 1961-1966 13360
OP 203-3 1977-1979 30202	VP 204-5 1977-1979 96034	EMS 203-3 1977-1979 90509	VS 203-3 1977-1979 50192	TCS 203-5 1977-1979 45011	RS 203-5 1977-1979 40012	SS 203-5 1977-1979 70861
OP 603-3 1965-1967 13419	VP 603-3 1965-1967 96004	EMS 603-5 1965-1967 90078	VS 605-5 1965-1967 13403	TCS 605-3 1965-1967 13417	RS 109-5 1965-1967 Rope 13044-2 ----- RS 512-5 1965-1967 Rubber 40032	SS 605-5 1965-1967 70393



ENGINE INFORMATION	HEAD GASKET	HEAD KIT With <u>NO</u> Valve Stem Seals	HEAD SET With Valve Stem Seals	KIT SET	SHORT BLOCK SET
--------------------	-------------	--	--------------------------------------	---------	-----------------

GM Buick, Cad, Chev, Geo, Olds, Pont, & Saturn: V8

7.0L 427 OHV V8 GEN IV Chevrolet Engine, 16 Vlv 1966-69	HG 309-3 1966-1969 8180-2	HK 309-3 1966-1969 8180-5 ----- HK 309-8 1966-1969 Special High Performance Rectangular Ports	HS 309-3 1966-1969 8180-5 ----- HS 309-8 1966-1969 Special High Performance Rectangular Ports	KS 309-3 1966-1969 8180-9 ----- KS 309-8 1966-1969 Special High Performance Rectangular Ports	ER 309-3 1966-1969 8180-9 ----- ER 309-8 1966-1969 Special High Performance Rectangular Ports
7.0L 428 OHV V8 Pontiac Engine, 16 Vlv 1967-69	HG 703-3 1967-1969 8518	HK 703-2 1967-1969 8518	HS 703-2 1967-1969 8518	KS 703-2 1967-1969 8518	ER 703-2 1967-1969 8518
7.0L 430 OHV V8 Buick Engine, 16 Vlv 1967-69	HG 107-5 1967-1969 8494	HK 107-5 1967-1969 8494	HS 107-5 1967-1969 8494	KS 107-5 1967-1969 8494	ER 107-5 1967-1969 8494
7.4L 454 OHV V8 GEN IV Chevrolet Engine, 16 Vlv 1970-76 VIN S 1976 VIN V 1972 VIN W 1972 VIN X 1973-1975 VIN Y 1973-1975 VIN Z 1973-1974	HG 309-3 1970-1976 8180-2	HK 309-3 1970-1976 8180-5 ----- HK 309-8 1970-1976 Special High Performance Rectangular Ports	HS 309-3 1970-1976 8180-5 ----- HS 309-8 1970-1976 Special High Performance Rectangular Ports	KS 309-3 1970-1976 8180-5 ----- KS 309-8 1970-1976 Special High Performance Rectangular Ports	ER 309-3 1970-1976 8180-5 ----- ER 309-8 1970-1976 Special High Performance Rectangular Ports
7.5L 455 OHV V8 Oldsmobile Engine, 16 Vlv 1968-76	HG 603-3 1968-1976 8171-1	HK 603-3 1968-1976 Valley Pan N/I 8171-1	HS 603-3 1968-1976 Valley Pan N/I 8171-1	KS 603-3 1968-1976 Valley Pan N/I 8171-1	ER 603-3 1968-1976 Valley Pan N/I 8171-1

OIL PAN SET	INTAKE MANIFOLD SET	EXHAUST MANIFOLD SET	VALVE COVER SET	TIMING COVER SET	REAR SEAL SET	VALVE STEM SEAL SET
-------------	---------------------	----------------------	-----------------	------------------	---------------	---------------------

GM Buick, Cad, Chev, Geo, Olds, Pont, & Saturn: V8

OP 309-3 1966-1969 30061-1	MS 309-2 1966-1969 90240-2 ----- MS 309-8 1966-1969 Special High Performance 90005	EMS 309-3 1966-1969 90206	VS 309-3 1966-1969 30055 ----- VS 309-5 1966-1969 Special Hi-Perf 5/16" C/R	TCS 309-3 1966-1969 45060	RS 309-5 1966-1969 40096-1	SS 309-5 1966-1969 71152 ----- SS 309-8 1966-1969 Dual Spring 72513
OP 703-3 1967-1969 30191-3	MS 703-3 1967-1969 9980	EMS 703-3 1967-1969 9499	VS 703-5 1967-1969 50005	TCS 703-3 1967-1969 13383-3	RS 703-5 1967 Rope 12173 ----- RS 109-5 1968-1969 Rope 13044-2	SS 703-3 1967-1969 13360 ----- SS 303-3 1967-1969 O-Ring 5112
OP 107-5 1967-1969 30185	VP 107-5 1967-1969 96005	EMS 107-5 1967-1969 90539	VS 107-5 1967-1969 50004	TCS 107-5 1967-1969 45002	RS 109-5 1967-1969 13044-2	SS 107-5 1967-1969 70092-1
OP 309-3 1970-1976 30061-1	MS 309-2 1970-1972 90240-2 ----- MS 309-1 1973-1974 90240 ----- MS 309-8 1970-1976 Special High Performance Rectangular Ports 90005	EMS 309-3 1970-1976 90206	VS 309-3 1970-1976 30055 ----- VS 309-5 1970-1976 Special Hi-Perf 5/16" C/R	TCS 309-3 1970-1976 45060	RS 309-5 1970-1976 40096-1	SS 309-5 1970-1976 71152 ----- SS 309-8 1970-1976 Dual Spring 72513
OP 603-3 1968-1976 13419	VP 603-4 1968-1972 96004 ----- VP 603-5 1973-1976 96015	EMS 603-5 1968-1974 90078 ----- EMS 603-3 1975-1976 90021	VS 605-5 1968-1976 13403	TCS 605-3 1968-1976 13417	RS 109-5 1968-1976 Rope 13044-2 ----- RS 512-5 1968-1976 Rubber 40032	SS 605-5 1968-1976 70393



ENGINE INFORMATION	HEAD GASKET	HEAD KIT With <u>NO</u> Valve Stem Seals	HEAD SET With Valve Stem Seals	KIT SET	SHORT BLOCK SET
--------------------	-------------	--	--------------------------------------	---------	-----------------

GM Buick, Cad, Chev, Geo, Olds, Pont, & Saturn: V8

7.5L 455 OHV V8 Pontiac Engine, 16 Vlv 1970-76	HG 703-3 1970-1976 8518	HK 703-3 1970-1976 8518	HS 703-3 1970-1976 8518	KS 703-3 1970-1976 8518	ER 703-3 1970-1976 8518
7.5L 455 OHV V8 Buick Engine, 16 Vlv 1970-76	HG 107-5 1970-1976 8494	HK 107-5 1970-1976 Valley Pan N/I 8494	HS 107-5 1970-1976 Valley Pan N/I 8494	KS 107-5 1970-1976 Valley Pan N/I 8494	ER 107-5 1970-1976 Valley Pan N/I 8494
7.7L 472 OHV V8 Cadillac Engine, 16 Vlv 1968-74	HG 203-3 1968-1974 8255	HK 203-3 1968-1974 Valley Pan N/I 8255	HS 203-3 1968-1974 Valley Pan N/I 8255	KS 203-3 1968-1974 Valley Pan N/I 8255	ER 203-3 1968-1974 Valley Pan N/I 8255
8.2L 500 OHV V8 Cadillac Engine, 16 Vlv 1970-76	HG 203-3 1970-1976 8255	HK 203-3 1970-1976 Valley Pan N/I 8255	HS 203-3 1970-1976 Valley Pan N/I 8255	KS 203-3 1970-1976 Valley Pan N/I 8255	ER 203-3 1970-1976 Valley Pan N/I 8255

GM Trucks, Mini-vans, & SUVs: 4 Cyl

1.6L 97 1590cc SOHC L4 Suzuki G16KC Engine, 8 Vlv 1989-95	HG 323-7 1989-1995 9683-1	HK 323-7 1989-1995 9683	HS 323-7 1989-1995 9683	KS 323-7 1989-1995 9683	ER 323-7 1989-1995 9683
---	---------------------------------	-------------------------------	-------------------------------	-------------------------------	-------------------------------

OIL PAN SET	INTAKE MANIFOLD SET	EXHAUST MANIFOLD SET	VALVE COVER SET	TIMING COVER SET	REAR SEAL SET	VALVE STEM SEAL SET
-------------	---------------------	----------------------	-----------------	------------------	---------------	---------------------

GM Buick, Cad, Chev, Geo, Olds, Pont, & Saturn: V8

OP 703-3 1970-1976 1 St. Design 3 Pin Rear Pan Seal 30191-3 ----- OP 703-4 1976 2nd Design 5 Slot Rear Pan Seal 30191-2	MS 703-3 1970-1971 Exc. H.O. 9980 ----- MS 703-5 1972-1976 Exc. H.O. & Super Duty 90205 ----- MS 703-6 1971-1976 H.O. & Super Duty 90123	EMS 703-3 1970-1976 Exc. H.O. & Super Duty 9499 ----- EMS 703-5 1970-1976 H.O. & Super Duty 90111	VS 703-5 1970-1976 50005 ----- VS 703-6 1970-1976 H.O. & Super Duty 50005AC	TCS 703-3 1970-1976 13383-3	RS 109-5 1970-1976 Rope 13044-2	SS 703-3 1970-1976 13360 ----- SS 303-3 1970-1976 O-Ring 5112
OP 107-5 1970-1976 30185	VP 107-5 1970-1971 96005 ----- VP 107-6 1972-1976 96014	EMS 107-5 1970-1976 90539	VS 107-5 1970-1976 50004	TCS 107-5 1970-1976 45002	RS 109-5 1970-1976 Rope 13044-2	SS 107-5 1970-1976 70092-1
OP 203-3 1968-1974 30202	VP 203-3 1968-1974 96028	EMS 203-3 1968-1974 90509	VS 203-3 1968-1974 50192	TCS 203-5 1968-1974 45011	RS 203-5 1968-1974 40012	SS 203-5 1968-1974 70861
OP 203-3 1970-1976 30202	VP 203-3 1970-1976 96028	EMS 203-3 1970-1976 90509	VS 203-3 1970-1976 50192	TCS 203-5 1970-1976 45011	RS 203-5 1970-1976 40012	SS 203-5 1970-1976 70861

GMC Trucks, Mini-vans, & SUVs: 4 Cyl

OP 323-2 1989-1995 30594	MS 323-6 1989-1995 94477	EMS 323-4 1989-1995 94478	VS 323-2 1989-1995 50323	TCS 313-2 1989-1995 Cam Frt Seal 45852 ----- TCS 323-4 1989-1995 Crank Frt Seal 45895	RS 324-5 1989-1995 40603	SS 323-2 1989-1995 72675-1
--------------------------------	--------------------------------	---------------------------------	--------------------------------	---	--------------------------------	----------------------------------



ENGINE INFORMATION	HEAD GASKET	HEAD KIT With <u>NO</u> Valve Stem Seals	HEAD SET With Valve Stem Seals	KIT SET	SHORT BLOCK SET
--------------------	-------------	--	--------------------------------------	---------	-----------------

GM Trucks, Mini-vans, & SUVs: 4 Cyl

1.6L 97 1590cc SOHC L4 Suzuki G16KV Engine, 16 Vlv 1994-2000	HG 323-7 1994-2000 9683-1	HK 323-8 1994-2000 9683-1	HS 323-8 1994-2000 9683-1	KS 323-8 1994-2000 9683-1	ER 323-8 1994-2000 9683-1
1.8L 110.8 1817cc SOHC L4 Isuzu G180Z Engine 1972-82	HG 941-5 1972-1975 8399 ----- HG 941-6 1976-1982 8621-1	HK 941-5 1972-1975 8399 ----- HK 941-6 1976-1982 8621-1	HS 941-5 1972-1975 8399 ----- HS 941-6 1976-1982 8621-1	KS 941-5 1972-1975 8399 ----- KS 941-6 1976-1982 8621-1	ER 941-5 1972-1975 8399 ----- ER 941-6 1976-1982 8621-1
1.9L 118.9 1949cc SOHC L4 Isuzu G200Z Engine S-10 1982-85	HG 941-6 1982-1985 8621-1	HK 941-6 1982-1985 8621-1	HS 941-6 1982-1985 8621-1	KS 941-6 1982-1985 8621-1	ER 941-6 1982-1985 8621-1
2.0L 121 OHV L4 Chevrolet Engine, 8 Vlv S-10 1983-84	HG 315-4 1983-1984 9129	HK 315-4 1983-1984 9129	HS 315-4 1983-1984 9129	KS 315-4 1983-1984 9129	ER 315-4 1983-1984 9129
2.2L 134 2189cc OHV L4 Chevrolet Engine, 8 Vlv 1994-2003 VIN 4 1994-2003 VIN 5 2000-2003 (FLEX FUEL)	HG 315-8 1994-2003 9170-1	HK 315-10 1994-1997 9170 ----- HK 315-11 1998-2002 9170-1	HS 315-10 1994-1997 9170 ----- HS 315-11 1998-2002 VIN 4 9170-1 ----- HS 315-12 2000-2003 VIN 5 2003 VIN 4 9170-2	KS 315-10 1994-1997 9170 ----- KS 315-11 1998-2002 VIN 4 9170-1 ----- KS 315-12 2000-2003 VIN 5 2003 VIN 4 9170-2	ER 315-10 1994-1997 9170 ----- ER 315-11 1998-2002 VIN 4 9170-1 ----- ER 315-12 2000-2003 VIN 5 2003 VIN 4 9170-2

OIL PAN SET	INTAKE MANIFOLD SET	EXHAUST MANIFOLD SET	VALVE COVER SET	TIMING COVER SET	REAR SEAL SET	VALVE STEM SEAL SET
-------------	---------------------	----------------------	-----------------	------------------	---------------	---------------------

GMC Trucks, Mini-vans, & SUVs: 4 Cyl

OP 323-2 1994-1995 30594 ----- OP 323-4 1996-2000 30698	MS 323-5 1994-2000 95402	EMS 323-5 1994-2000 95032	VS 323-5 1994-2000 50473	TCS 313-2 1994-2000 Cam Frt Seal 45852 ----- TCS 323-5 1994-2000 Crank Frt Seal 45895	RS 324-5 1994-2000 40603	SS 947-5 1994-2000 70360
OP 941-5 1973-1975 30389 ----- OP 941-6 1976-1982 30390	MS 941-5 1972-1975 90363 ----- MS 941-6 1976-1982 90394	EMS 1972-1975 USE MS ----- EMS 941-5 1976-1982 90461	VS 941-5 1972-1975 Side Cover 50165 ----- VS 941-6 1976-1982 w/Half Moon Plug & Grommets 50097	TCS 941-5 1972-1982 Use w/ OP Set 1976-1982 Use w/ OP & VC 45113	RS 941-5 1972-1982 Radial 40460	SS 947-5 1972-1982 27149
OP 941-6 1982-1985 30390	MS 941-6 1982-1985 90394	EMS 941-5 1982-1985 90461	VS 941-6 1982-1985 w/Half Moon Plug & Grommets 50097	TCS 941-5 1982-1985 Use w/ OP & VC 45113	RS 941-5 1982-1985 Radial 40460	SS 947-5 1982-1985 27149
OP 315-8 1983-1984 30464	MS 315-5 1983-1984 91390	EMS 315-5 1983-1984 91457	VS 315-5 1983-1984 50222	TCS 315-8 1983-1984 45581	RS 315-3 1983-1984 1st Design 2 Pc. 40422 ----- RS 315-5 1983-1984 2nd Design 5.5 mm Radial 40465 ----- RS 315-6 1983-1984 2nd Design 11.0 mm Radial 40464	SS 315-5 1983-1984 70816
OP 315-6 1994-2003 34300	MS 315-7 1994-1997 95393 ----- MS 315-8 1998-2003 90543	EMS 315-6 1994-1997 93812 ----- EMS 315-8 1998-2002 VIN 4 90540 ----- EMS 315-9 2000-2002 VIN 5 2003 VIN 4 92794	VS 315-6 1994-1997 50313 ----- VS 315-8 1998-2003 50485	TCS 315-6 1994-2003 45793	RS 315-6 1994-2003 11.0 mm Radial 40464 ----- RS 315-8 1994-2003 11.0 mm Radial PTFE 40625	SS 314-6 1994-1997 72852 ----- SS 315-6 1998-2003 70809



ENGINE INFORMATION	HEAD GASKET	HEAD KIT With <u>NO</u> Valve Stem Seals	HEAD SET With Valve Stem Seals	KIT SET	SHORT BLOCK SET
--------------------	-------------	--	--------------------------------------	---------	-----------------

GM Trucks, Mini-vans, & SUVs: 4 Cyl

<p>2.3L 138 DOHC L4 Oldsmobile Engine, 16 Vlv 1993-95</p> <p>VIN G 1993-1995 (Quad 4)</p>	<p>HG 138-5 1993-1995 9515</p>	<p>HK 138-5 1993-1994 20 Bolt TCS N/I 9515-2</p>	<p>HS 138-5 1993-1994 20 Bolt TCS N/I 9515-2 ----- HS 138-6 1995 20 Bolt TCS N/I 9515-3</p>	<p>KS 138-5 1993-1994 20 Bolt TCS N/I 9515-2 ----- KS 138-6 1995 20 Bolt TCS N/I 9515-3</p>	<p>ER 138-5 1993-1994 20 Bolt TCS N/I 9515-2 ----- ER 138-6 1995 20 Bolt TCS N/I 9515-3</p>
<p>2.5L 151 OHV L4 Pontiac Engine, 8 Vlv 1985-93</p> <p>VIN A 1991-1993 VIN E 1985-1991 NEW</p> <p>HEAD BOLTS RECOMMENDED</p>	<p>HG 312-6 1985-1993 9405-1</p> <p>Head Bolts HB 312-6 1985-1993 72733</p>	<p>HK 312-6 1985-1986 9405 ----- HK 312-7 1987 9405-3 ----- HK 312-9 1988-1991 VIN E 9405-4 ----- HK 312-11 1991-1993 VIN A 9405-5</p>	<p>HS 312-6 1985-1986 9405 ----- HS 312-7 1987 9405-3 ----- HS 312-9 1988-1991 VIN E 9405-4 ----- HS 312-11 1991-1993 VIN A 9405-5</p>	<p>KS 312-6 1985-1986 9405 ----- KS 312-7 1987 9405-3 ----- KS 312-9 1988-1991 VIN E 9405-4 ----- KS 312-11 1991-1993 VIN A 9405-5</p>	<p>ER 312-6 1985-1986 9405 ----- ER 312-7 1987 9405-3 ----- ER 312-9 1988-1991 VIN E 9405-4 ----- ER 312-11 1991-1993 VIN A 9405-5</p>
<p>2.5L 153 OHV L4 Chevrolet Engine, 8 Vlv 1963-67</p>	<p>HG 300-5 1963-1967 8531-1</p>	<p>HK 300-5 1963-1967 8531-1</p>	<p>HS 300-5 1963-1967 8531-1</p>	<p>KS 300-5 1963-1967 8531-1</p>	<p>ER 300-5 1963-1967 8531-1</p>
<p>2.8L 169 DOHC L4 Chevrolet LK5 Colorado Engine, 16 Vlv 2004-2006</p> <p>VIN 8 2004-2006</p>	<p>HG 329-2 2004-2006 26335</p>	<p>HK 329-2 2004-2006 26335</p>	<p>HS 329-2 2004-2006 26335</p>	<p>KS 329-2 2004-2006 26335</p>	<p>ER 329-2 2004-2006 26335</p>
<p>2.9L 177 DOHC L4 Chevrolet Colorado Engine, 16 Vlv 2007-2011</p> <p>VIN 2007-2011</p>	<p>HG 329-2 2007-2011 26335</p>	<p>HK 329-2 2007-2011 26335</p>	<p>HS 329-2 2007-2011 26335</p>	<p>KS 329-2 2007-2011 26335</p>	<p>ER 329-2 2007-2011 26335</p>

OIL PAN SET	INTAKE MANIFOLD SET	EXHAUST MANIFOLD SET	VALVE COVER SET	TIMING COVER SET	REAR SEAL SET	VALVE STEM SEAL SET
-------------	---------------------	----------------------	-----------------	------------------	---------------	---------------------

GMC Trucks, Mini-vans, & SUVs: 4 Cyl

OP 138-5 1993-1994 30597 ----- OP 138-6 1995 30678	MS 138-5 1993-1995 90573	EMS 138-5 1993-1994 90559 ----- OP 138-6 1995 91130	VS 138-5 1993-1994 1 st Design Int & Exh. 50325 ----- VS 138-6 1993-1995 2nd Design Intake Cover 50444 ----- VS 138-7 1993-1995 2nd Design Exhaust Cover 50445	TCS 138-5 1993-1995 1 st Design 20 Bolt Hole .70 mm Thick 45843 ----- TCS 138-6 1993-1995 2nd Design 21 Bolt Hole 3.40 mm Thick 45954	RS 138-5 1993-1995 Radial 40591	SS 138-5 1993-1995 70287
OP 312-5 1985-1993 30409	MS 312-5 1985-1986 90563 ----- MS 312-6 1987-1991 VIN E 93688 ----- MS 312-8 1991-1993 VIN A 94278	EMS 312-5 1985-1986 90564 ----- EMS 312-6 1987-1993 VIN A, E 93689	VS 312-5 1985-1987 50179 ----- VS 312-6 1988-1993 50329 ----- Push Rod Cover ----- PS 312-5 1985-1993 50276	TCS 312-6 1985-1993 13198-2	RS 312-5 1985-1993 Radial 40578	SS 312-6 1985-1986 72531 ----- SS 312-8 1987-1993 72684
OP 311-5 1963-1967 30139-1	MS 300-5 1963-1967 9772	USE MS	VS 300-5 1963-1967 13197	TCS 302-3 1963-1967 13198	RS 302-1 1963-1967 13241	SS 302-5 1963-1967 O-Ring 5112
OP 329-2 2004-2006 USE RTV	MS 329-2 2004-2006	EMS 329-2 2004-2006	VS 329-2 2004-2006	TCS 320-2 2004-2006	RS 329-2 2004-2006	SS 329-2 2004-2006
OP 329-2 2007-2011 USE RTV	MS 329-2 2007-2011	EMS 329-2 2007-2011	VS 329-2 2007-2011	TCS 329-2 2007-2011	RS 329-2 2007-2011	SS 329-2 2007-2011



ENGINE INFORMATION	HEAD GASKET	HEAD KIT With <u>NO</u> Valve Stem Seals	HEAD SET With Valve Stem Seals	KIT SET	SHORT BLOCK SET
--------------------	-------------	--	--------------------------------------	---------	-----------------

GM Trucks, Mini-vans, & SUVs: 5 Cyl

3.5L 217 3460cc DOHC L5 2004-2008 L52 Colorado VIN 6 2004-2008	HG 335-2 2004-2006 26336 Head Bolt Set HB 335-1 2004-2006 72195	HK 335-1 2004-2006 26336	HS 335-1 2004-2006 26336	KS 335-1 2004-2006 26336	ER 335-1 2004-2006 26336
3.7L 226 3650cc DOHC L5 2007-2011 L52 Colorado VIN 2007-2011	HG 335-4 2007-2010 Head Bolt Set HB 335-1 2007-2010 72195	HK 335-2 2007-2010	HS 335-2 2007-2010	KS 335-2 2007-2010	ER 335-2 2007-2010

GM Trucks, Mini-vans, & SUVs: 6 Cyl

2.8L 173 2835cc OHV V6 1982-1993 S-10 VIN B 82-85 VIN R 86-93	HG 305-5 1982-1993 8699-1 Head Bolt Set HB 305-4 1982-1993 72857	HK 305-5 1982-1985 8699-4 ----- HK 305-6 1986-1993 8699-6	HS 305-5 1982-1985 8699-4 ----- HS 305-6 1986-1993 8699-6	KS 305-5 1982-1985 8699-4 ----- KS 305-6 1986-1993 8699-6	ER 305-5 1982-1985 8699-4 ----- ER 305-6 1986-1993 8699-6
3.0L 181 2962cc DOHC V6 Opel Engine, 24 Vlv 2002-2003 VIN B 2002-2003	HG 319-4 2002-2003 26173	HK 319-5 2002-2003	HS 319-5 2002-2003	KS 319-5 2002-2003	ER 319-5 2002-2003

OIL PAN SET	INTAKE MANIFOLD SET	EXHAUST MANIFOLD SET	VALVE COVER SET	TIMING COVER SET	REAR SEAL SET	VALVE STEM SEAL SET
-------------	---------------------	----------------------	-----------------	------------------	---------------	---------------------

GM Trucks, Mini-vans, & SUVs: 5 Cyl

OP 335-1 2004-2006 Use RTV	MS 335-2 2004-2006 96440-2	EMS 335-1 2004-2006 96849	VS 335-1 2004-2006 50703	TCS 335-1 2004-2006 45052	RS 335-2 2004-2006 40705	SS 335-2 2004-2006 71043-2
OP 335-1 2007-2010 Use RTV	MS 335-2 2007-2010 96440-2	EMS 335-1 2007-2010 96849	VS 335-1 2007-2010 50703	TCS 335-1 2007-2010 45052	RS 335-2 2007-2010 40705	SS 335-2 2007-2010 71043-2

GM Trucks, Mini-vans, & SUVs: 6 Cyl

OP 305-5 1982-1985 1 st Design w/5.5 mm Rear Main Seal 30411 ----- OP 305-8 1985-1986 2nd Design w/11.0 mm Rear Main Seal 30512 ----- OP 305-6 1985-1986 Goodwrench Eng. 1987-1993 1 Pc Silicone 34501	MS 305-6 1982-1993 91022	EMS 305-5 1982-1993 90864	VS 305-5 1982-1985 50182 ----- VS 305-6 1986-1993 50272	TCS 305-5 1982-1986 45466 ----- TCS 305-7 1987-1993 Use w/OP 45828	RS 315-3 1985 1st Design 2 Pc. 40422 ----- RS 315-5 1985 2nd Design 5.5 mm Radial 40465 ----- RS 315-6 1986-1993 2nd Design 11.0 mm Radial 40464 ----- RS 315-8 1986-1993 11.0 mm Radial PTFE 40625	SS 305-5 1982-1993 72530
OP RTV Sealant	MS 319-5 2002-2003 96102	EMS 319-5 2002-2003 96425	VS 319-5 2002-2003 50565	TCS 319-4 2002-2003 Crank Seal 46014 ----- TCS 319-6 2002-2003 Cam Seal Set 45603 4 Required	RS 319-5 2002-2003 40671	SS 319-5 2002-2003 71163



ENGINE INFORMATION	HEAD GASKET	HEAD KIT With <u>NO</u> Valve Stem Seals	HEAD SET With Valve Stem Seals	KIT SET	SHORT BLOCK SET
--------------------	-------------	--	--------------------------------------	---------	-----------------

GM Trucks, Mini-vans, & SUVs: 6 Cyl

3.1L 189 3136cc OHV V6 Chevrolet Engine, 12 Vlv 1990-95 VIN D	HG 305-5 1990-1995 8699-2 Head Bolt Set HB 305-9 1990-1991 72901	HK 305-10 1990-1995 8699-7	HS 305-10 1990-1995 8699-7	KS 305-10 1990-1995	ER 305-10 1990-1995
3.2L 194 OHV L6 Chevrolet Engine, 12 Vlv 1963-66 LIGHT DUTY TRUCK	HG 302-5 1963-1966 8006	HK 302-5 1963-1966 8006-1	HS 302-5 1963-1966 8006-1	KS 302-5 1963-1966 8006-4	ER 302-5 1963-1966 8006-4
3.3L 200 OHV V6 Chevrolet Engine, 12 Vlv 1978-79 VIN M 1978-1979	HG 304-5 1978-1979 8629	HK 304-5 1978-1979 8629	HS 304-5 1978-1979 8629	KS 304-5 1978-1979 8629	ER 304-5 1978-1979 8629
3.4L 207 3393cc OHV V6 Chevrolet Engine, 12 Vlv 1996-2005 VIN E 1996-2005 VIN F 2004-2005	HG 305-9 1996-2006 9071 Head Bolt Set HB 305-8 1996-2006 72892	HK 305-11 1996-2003 9071, -1	HS 305-7 1996-1999 9071 ----- HS 305-11 2000-2003 9071-1	KS 305-7 1996-1999 9071 ----- KS 305-11 2000-2003 9071-1	ER 305-7 1996-1999 9071 ----- ER 305-11 2000-2003 9071-1
3.8L 229 OHV V6 Chevrolet Engine, 12 Vlv 1980-84 VIN K 1980-1982 VIN 9 1983-1984	HG 304-5 1980-1984 8721	HK 304-5 1980-1984 8721	HS 304-5 1980-1984 8721	KS 304-5 1980-1984 8721	ER 304-5 1980-1984 8721
3.8L 230 OHV L6 Chevrolet Engine, 12 Vlv 1963-69 LIGHT DUTY TRUCK	HG 302-5 1963-1969 8006	HK 302-5 1963-1969 8006-1	HS 302-5 1963-1969 8006-1	KS 302-3 1963-1969 8006-4	ER 302-5 1963-1969 8006-4

OIL PAN SET	INTAKE MANIFOLD SET	EXHAUST MANIFOLD SET	VALVE COVER SET	TIMING COVER SET	REAR SEAL SET	VALVE STEM SEAL SET
-------------	---------------------	----------------------	-----------------	------------------	---------------	---------------------

GM Trucks, Mini-vans, & SUVs: 6 Cyl

OP 305-6 1990-1995 34501	MS 305-6 1990-1995 91022	EMS 305-5 1990-1995 90864	VS 305-6 1990-1995 50272	TCS 305-7 1990-1995 45828	RS 315-6 1990-1995 Radial 40464	SS 305-5 1990-1995 72530
OP 302-3 1963-1966 30126-1	MS 302-3 1963-1966 9786	USE MS	VS 302-3 1963-1966 13173-1	TCS 302-3 1963-1966 13198	RS 302-1 1963-1966 13241	SS 302-5 1963-1966 O-RING 5112
OP 304-5 1978-1979 30386	MS 304-5 1978-1979 90391	EMS 304-5 1978-1979 90714	VS 304-5 1978-1979 50170	TCS 303-5 1978-1979 45121	RS 303-5 1978-1979 2 Pc. Silicone 40013	SS 302-5 1978-1979 O-RING 5112
OP 305-9 1996-2005 30668	MS 305-10 1996-2005 Upper & Lower Set 90565 ----- MS 305-11 1996-2005 Upper Set 90505 ----- MS 305-12 1996-2005 Upper & Lower & Valve Cover Set 98003	EMS 305-10 1996-2003 95586	VS 305-10 1996-2005 50442	TCS 305-7 1996-2005 45828	RS 315-6 1996-2005 Radial 40464	SS 305-11 1996-1999 72851 ----- SS 305-12 2000-2005 70829
OP 304-5 1980-1984 30386	MS 304-5 1980-1984 90391	EMS 304-5 1980-1984 90714	VS 304-5 1980-1984 50070	TCS 303-5 1980-1984 45121	RS 303-5 1980-1984 2 Pc. Silicone 40013	SS 302-5 1980-1984 O-RING 5112
OP 302-3 1963-1969 30126-1	MS 302-3 1963-1969 9786	USE MS	VS 302-3 1963-1969 13173-1 ----- PS 302-5 1963-1969 13228	TCS 302-3 1963-1969 13198	RS 302-1 1963-1969 13241	SS 302-5 1963-1969 O-Ring 5112



ENGINE INFORMATION	HEAD GASKET	HEAD KIT With <u>NO</u> Valve Stem Seals	HEAD SET With Valve Stem Seals	KIT SET	SHORT BLOCK SET
--------------------	-------------	--	--------------------------------------	---------	-----------------

GM Trucks, Mini-vans, & SUVs: 6 Cyl

<p>3.8L 231 OHV V6 Buick Engine, 12 Vlv 1978-95</p> <p>VIN A 1978-1984 VIN L 1992-1995</p>	<p>HG 109-5 1978-1984 8723-1 ----- HG 109-10 1992-1995 9644</p>	<p>HK 109-5 1978-1984 Valley Pan Not Included 8723-1 ----- HK 109-16 1992-1995 Upper Intake Manifold Not Included 9644</p>	<p>HS 109-5 1978-1983 Valley Pan Not Included w/.605 I.D. VSS 8723-4 ----- HS 109-6 1983-1984 Valley Pan Not Included w/.552 I.D. VSS 8723-5 ----- HS 109-16 1992-1995 Upper Intake Manifold Not Included 9644-1</p>	<p>KS 109-5 1978-1983 Valley Pan Not Included w/.605 I.D. VSS 8723-4 ----- KS 109-6 1983-1984 Valley Pan Not Included w/.552 I.D. VSS 8723-5 ----- KS 109-16 1992-1995 Upper Intake Manifold Not Included 1995 OP N/I. 9644-1</p>	<p>ER 109-5 1978-1983 Valley Pan Not Included w/.605 I.D. VSS 8723-4 ----- ER 109-6 1983-1984 Valley Pan Not Included w/.552 I.D. VSS 8723-5 ----- ER 109-16 1992-1995 Upper Intake Manifold Not Included 1995 OP N/I 9644-1</p>
<p>3.8L 235 OHV L6 Chevrolet Engine, 12 Vlv 1950-63</p> <p>LIGHT DUTY TRUCK</p>	<p>HG 301-1 1950-1952 7539 ----- HG 301-5 1953-63 7619-2</p>	<p>HK 301-1 1950-1952 7539 ----- HK 301-5 1953-63 7619-2</p>	<p>HS 301-1 1950-1952 7539 ----- HS 301-5 1953-63 7619-2</p>	<p>KS 301-1 1950-1952 7539 ----- KS 301-5 1953-63 7619-2</p>	<p>ER 301-1 1950-1952 7539 ----- ER 301-5 1953-63 7619-2</p>
<p>4.1L 250 OHV L6 Chevrolet Engine, 12 Vlv 1966-84</p> <p>LIGHT DUTY TRUCK VIN D 1972-1984 VIN Q 1972-1975</p>	<p>HG 302-5 1966-1978 8006 ----- HG 307-5 1975-1978 Integral Head 8501-1 ----- HG 307-7 1979-1984 Integral Head 8695</p>	<p>HK 302-5 1966-1978 8006 ----- Hk 307-5 1975-1978 Integral Head 8501-1 ----- Hk 307-7 1979-1984 Integral Head 8695</p>	<p>HS 302-5 1966-1978 8006 ----- HS 307-5 1975-1978 Integral Head 8501-1 ----- HS 307-7 1979-1984 Integral Head 8695</p>	<p>KS 302-5 1966-1978 8006 ----- KS 307-5 1975-1978 Integral Head 8501-1 ----- KS 307-7 1979-1984 Integral Head 8695</p>	<p>ER 302-5 1966-1978 8006 ----- ER 307-5 1975-1978 Integral Head 8501-1 ----- ER 307-7 1979-1984 Integral Head 8695</p>



OIL PAN SET	INTAKE MANIFOLD SET	EXHAUST MANIFOLD SET	VALVE COVER SET	TIMING COVER SET	REAR SEAL SET	VALVE STEM SEAL SET
-------------	---------------------	----------------------	-----------------	------------------	---------------	---------------------

GM Trucks, Mini-vans, & SUVs: 6 Cyl

<p>OP 109-5 1978-1983 & 1984 w/14 Bolt Oil Pan 13398-1 ----- OP 109-7 1984 w/20 Bolt Pan 30521 ----- OP 109-9 1992-1994 30522 ----- OP 109-10 1995 34410</p>	<p>VP 109-4 1978 96032 ----- VP 109-6 1979-1983 & 1984 w/Cast Iron Intake 96033 ----- VP 109-8 1984 w/Aluminum Intake 96037 ----- MS 109-16 1992-1995 Lower Set 94918-1 ----- MS 109-22 1993 1995 Upper Plenum 95830</p>	<p>EMS 109-2 1978 90198 ----- EMS 109-5 1979-1984 90508 ----- EMS 109-12 1992-1995 94052</p>	<p>VS 109-5 1978-1984 50156 ----- VS 109-12 1992-1995 w/o Grommets 50080</p>	<p>TCS 106-5 1978-1984 Rope 45006 ----- TCS 109-6 1978-1984 Rubber Seal 45930 ----- TCS 109-10 1992-1995 Use w/Oil Pan 45840</p>	<p>RS 109-5 1978-1984 Rope 13044-2 ----- RS 109-6 1978-1984 2 pc. Rubber 40613 ----- RS 109-7 1992-1995 Radial Seal 40621</p>	<p>SS 109-5 1978-1983 .605 O.D. Guide 70731 ----- SS 109-6 1983-1984 .551 O.D. Guide 72623 ----- SS 109-7 1992-1995 72700</p>
<p>OP 301-5 1950-1963 5041 -5153</p>	<p>MS 301-5 1950-1963 9193</p>	<p>USE MS</p>	<p>VS 301-5 1950-1963 50190</p>	<p>TCS 301-5 1950-1963 45114</p>	<p>RS 301-5 1950-1954 Rope 5048 ----- RS 301-6 1955-1963 2 Pc. Silicone 13363</p>	<p>SS 302-5 1950-1963 O-RING 5112</p>
<p>OP 302-3 1966-1979 24 Bolt Pan 30126-1 ----- OP 302-5 1980-1984 16 Bolt Pan 30462</p>	<p>MS 302-3 1966-1978 9786</p>	<p>EMS 307-5 1975-1978 Integral Head 90324 ----- EMS 307-7 1979-1984 Integral Head 90590</p>	<p>VS 302-3 1966-1978 13173-1 ----- VS 307-5 1975-1984 Integral Head 50181</p>	<p>TCS 302-3 1966-1984 13398, -1</p>	<p>RS 302-1 1966-1967 13241 ----- RS 303-5 1968-1984 2 Pc. Silicone 40013</p>	<p>SS 302-5 1966-1984 O-RING 5112</p>



ENGINE INFORMATION	HEAD GASKET	HEAD KIT With <u>NO</u> Valve Stem Seals	HEAD SET With Valve Stem Seals	KIT SET	SHORT BLOCK SET
--------------------	-------------	--	--------------------------------------	---------	-----------------

GM Trucks, Mini-vans, & SUVs: 6 Cyl

4.2L 254 DOHC L6 Chevrolet Engine, 24 Vlv Vortec 4200 2002-2008 VIN S 2002-2008	HG 328-5 2002-2003 26213 ----- HG 328-6 2004-2008 26214 Head Bolts HB 328-5 2002-2008 72195	HK 328-5 2002-2003 26213 ----- HK 328-6 2004 26214 ----- HK 328-7 2005 26214-1 ----- HK 328-8 2006-2008 26214-2	HS 328-5 2002-2003 26213 ----- HS 328-6 2004 26214 ----- HS 328-7 2005 26214-1 ----- HS 328-8 2006-2008 26214-2	KS 328-5 2002-2003 26213 ----- KS 328-6 2004 26214 ----- KS 328-7 2005 26214-1 ----- KS 328-8 2006-2008 26214-2	N/A
4.3L 261 OHV L6 Chevrolet Engine, 12 Vlv 1961-62 LIGHT DUTY TRUCK	HG 301-4 1961-1962 7782	HK 301-4 1961-1962 7782	HS 301-4 1961-1962 7782	KS 301-4 1961-1962 7782	ER 301-4 1961-1962 7782



OIL PAN SET	INTAKE MANIFOLD SET	EXHAUST MANIFOLD SET	VALVE COVER SET	TIMING COVER SET	REAR SEAL SET	VALVE STEM SEAL SET
-------------	---------------------	----------------------	-----------------	------------------	---------------	---------------------

GM Trucks, Mini-vans, & SUVs: 6 Cyl

<p>OP RTV Sealant</p>	<p>MS 328-5 2002-2004 96294 ----- MS 328-6 2005-2006 96440 ----- Throttle Body TB 328-5 2002-2008 61337</p>	<p>EMS 328-5 2002-2005 96302 ----- EMS 328-6 2006-2008 96707</p>	<p>VS 328-5 2002-2005 w/Spark Plug Seals 50584 ----- VS 328-6 2006-2008 50667 ----- SPT 328-5 Spark Plug Tube Seal Set</p>	<p>TCS 328-3 2002-2003 2004-2005 1st Design Balancer w/o Step on Hub 45051 ----- TCS 328-5 2004-2008 2nd Design Balancer w/Step on Hub 45052</p>	<p>RS 328-5 2002-2008 Radial 40678</p>	<p>SS 328-5 2002-2004 71043-1 ----- SS 328-6 2005-2008 71237</p>
<p>OP 301-5 1962-1963 5153</p>	<p>MS 301-5 1962-1963 9193</p>	<p>USE MS</p>	<p>VS 301-5 1962-1963 50190</p>	<p>TCS 301-5 1962-1963 45114</p>	<p>RS 301-6 1962-1963 2 Pc. Silicone 13363</p>	<p>SS 302-5 1962-1963 O-RING 5112</p>



ENGINE INFORMATION	HEAD GASKET	HEAD KIT With <u>NO</u> Valve Stem Seals	HEAD SET With Valve Stem Seals	KIT SET	SHORT BLOCK SET
--------------------	-------------	--	--------------------------------------	---------	-----------------

GM Trucks, Mini-vans, & SUVs: 6 Cyl

<p>4.3L 262 OHV V6 Chevrolet Engine, 12 Vlv 1985-2005</p> <p>VIN B 1990-1991 (H.O.) VIN N 1985-1986 VIN W 1992-2005 (H.O.) VORTEC VIN X 1996-1999 VIN Z 1985-1995</p>	<p>HG 304-7 1985-2004 9354-1</p> <p>Head Bolts HB 304-7 1985-2004 2 Required 74034</p>	<p>HK 304-7 1985 1986 Exc. Astro & Safari 9354 ----- HK 304-8 1986 Astro & Safari 1987-1992 VIN B, Z 9354-1 ----- HK 304-9 1993 VIN Z 9354-2 ----- HK 304-10 1994-1995 VIN Z 9354-5 ----- HK 304-11 1992-1993 VIN W VORTEC 9354-3 ----- HK 304-12 1994-1995 VIN W VORTEC 9354-4 ----- HK 304-13 1996-2005 VIN W, X VORTEC 9354-6</p>	<p>HS 304-7 1985 1986 Exc. Astro & Safari 9354 ----- HS 304-8 1986 Astro & Safari 1987-1992 VIN B, Z 9354-1 ----- HS 304-9 1993 VIN Z 9354-2 ----- HS 304-10 1994-1995 VIN Z 9354-5 ----- HS 304-11 1992-1993 VIN W VORTEC 9354-3 ----- HS 304-12 1994-1995 VIN W VORTEC 9354-4 ----- HS 304-13 1996-2005 VIN W, X VORTEC 9354-6</p>	<p>KS 304-7 1985 1986 Exc. Astro & Safari 9354 ----- KS 304-8 1986 Astro & Safari 1987-1992 VIN B, Z 9354-1 ----- KS 304-9 1993 VIN Z 9354-2 ----- KS 304-10 1994-1995 VIN Z 9354-5 ----- KS 304-11 1992-1993 VIN W VORTEC 9354-3 ----- KS 304-12 1994-1995 VIN W VORTEC 9354-4 ----- KS 304-13 1996-2005 VIN W, X VORTEC 9354-6</p>	<p>ER 304-7 1985 1986 Exc. Astro & Safari 9354 ----- ER 304-8 1986 Astro & Safari 1987-1992 VIN B, Z 9354-1 ----- ER 304-9 1993 VIN Z 9354-2 ----- ER 304-10 1994-1995 VIN Z 9354-5 ----- ER 304-11 1992-1993 VIN W VORTEC 9354-3 ----- ER 304-12 1994-1995 VIN W VORTEC 9354-4 ----- ER 304-13 1996-2005 VIN W, X VORTEC 9354-6</p>
<p>4.3L 262 OHV Turbo V6 Chevrolet Engine, 12 Vlv 1991-93</p> <p>VIN Z 1991-1993</p>	<p>HG 304-7 1985-2004 9354-1</p>	<p>HK N/A</p>	<p>HS N/A</p>	<p>KS N/A</p>	<p>ER N/A</p>
<p>4.8L 292 OHV L6 Chevrolet Engine, 12 Vlv 1963-89</p> <p>VIN T 1972-1989</p>	<p>HG 302-5 1963-1978 8006-1 ----- HG 307-7 1979-89 8501-1</p>	<p>HK 302-5 1963-1978 8006-1 ----- HK 307-7 1979-89 8501-5,6</p>	<p>HS 302-5 1963-1978 8006-1 ----- HS 307-7 1979-89 8501-5,6</p>	<p>KS 302-5 1963-1978 8006-4 ----- KS 307-7 1979-89 2 PAN SET 8501-3,4</p>	<p>ER 302-5 1963-1978 8006-4 ----- ER 307-7 1979-89 2 PAN SET 8501-3,4</p>

OIL PAN SET	INTAKE MANIFOLD SET	EXHAUST MANIFOLD SET	VALVE COVER SET	TIMING COVER SET	REAR SEAL SET	VALVE STEM SEAL SET
-------------	---------------------	----------------------	-----------------	------------------	---------------	---------------------

GM Trucks, Mini-vans, & SUVs: 6 Cyl

<p>OP 304-5 1985 30386 -----</p> <p>OP 304-7 1986-1995 SILICONE 34502 -----</p> <p>OP 304-8 1996-2005 VIN W, X VORTEC 30680</p>	<p>MS 304-6 1985 1986 Exc. Astro, Safari 93040 -----</p> <p>MS 304-7 1986 Astro, Safari 1987-1995 VIN B, Z 93346 93346-1 -----</p> <p>MS 304-8 1992-1995 VIN W Lower Set 95832 -----</p> <p>MS 304-9 1992-1995 Upper Plenum VIN W 95818 -----</p> <p>MS 304-12 1996-2005 VIN W, X Upper & Lower Set 95817 -----</p> <p>MS 304-11 1996-2005 Upper Set VIN W, X 95816</p>	<p>EMS 304-6 1990-1996 VIN B, N, Z 90746 -----</p> <p>EMS 304-8 1992-2005 VIN W, X 95842</p>	<p>VS 304-6 1985-1993 Flat Silicone 50086 -----</p> <p>VS 304-8 1994-2005 Beaded Silicone w/grommets 50464</p>	<p>TCS 303-5 1985-1995 VIN B,N,Z 45121 -----</p> <p>TCS 304-6 1992-1995 VIN W Must be used w/ Oil Pan 45947 -----</p> <p>TC 304-10 Plastic Cover Assy. with Sensor Hole 1986-2005 Must be used w/ Oil Pan</p>	<p>RS 303-5 1985 2 Pc. Silicone 40013 -----</p> <p>RS 303-8 1986-1995 Radial 40520 -----</p> <p>RS 303-9 1986-95 Radial PTFE 40626 -----</p> <p>RS 303-10 1999-2005 Radial 40656</p>	<p>SS 304-5 1985-1986 72529 -----</p> <p>SS 304-7 1987-1995 72530 72876 -----</p> <p>SS 304-8 1996-2005 72861-1</p>
<p>OP 304-7 1991-1993 Silicone 34502</p>	<p>MS N/A</p>	<p>EMS 304-8 1991-1993 95842</p>	<p>VS 304-6 1991-1993 50086</p>	<p>TCS 303-5 1991-1993 45121</p>	<p>RS 303-8 1991-1993 Radial 40520</p>	<p>SS 304-7 1991-1993 72530 72876</p>
<p>OP 302-3 1963-1978 1980-1989 24 Bolt Pan 30126-1 -----</p> <p>OP 302-5 1979-1980 16 Bolt Pan 30462</p>	<p>MS 302-3 1963-1989 9786</p>	<p>USE MS</p>	<p>VS 302-3 1963-1989 13173-1 ----- Push Rod Cover PS 302-5 1963-1989 13315</p>	<p>TCS 302-3 1963-1989 13198</p>	<p>RS 302-1 1963-1967 Not In Kits 13241 -----</p> <p>RS 303-5 1968-1989 2 Pc. Silicone 40013</p>	<p>SS 302-5 1963-1984 O-RING 5112 -----</p> <p>SS 305-5 1985-1995 72530</p>



ENGINE INFORMATION	HEAD GASKET	HEAD KIT With <u>NO</u> Valve Stem Seals	HEAD SET With Valve Stem Seals	KIT SET	SHORT BLOCK SET
--------------------	-------------	--	--------------------------------------	---------	-----------------

GM Trucks, Mini-vans, & SUVs: V8

4.3L 265 OHV V8 Chevrolet Engine, 16 Vlv 1955-57	HG 303-3 1955-57 7733-2 Head Bolt Set HB 303-5 1955-1957 72856	HK 303-3 1955-57 7733-1,2	HS 303-3 1955-57 7733-1,2	KS 303-3 1955-57 7733-1,2	ER 303-3 1955-57 7733-1,2
4.4L 267 OHV V8 Chevrolet Engine, 16 Vlv 1979-82 VIN J 1979-1982	HG 303-6 1979-1982 8510 Head Bolt Set HB 303-5 1979-1982 72856	HK 303-6 1979-1982 8510	HS 303-6 1979-1982 8510	KS 303-6 1979-1982 8510	ER 303-6 1979-1982 8510
4.6L 283 OHV V8 Chevrolet Engine, 16 Vlv 1957-67	HG 303-3 1957-1967 7733-2 Head Bolt Set HB 303-5 1957-1967 72856	HK 303-3 1957-1967 7733-2	HS 303-3 1957-1967 7733-2	KS 303-3 1957-1958 Rope RS Not Included 1957-1967 7733-2	ER 303-3 1957-1967 7733-2



OIL PAN SET	INTAKE MANIFOLD SET	EXHAUST MANIFOLD SET	VALVE COVER SET	TIMING COVER SET	REAR SEAL SET	VALVE STEM SEAL SET
-------------	---------------------	----------------------	-----------------	------------------	---------------	---------------------

GM Trucks, Mini-vans, & SUVs: V8

<p>OP 303-2 1955-57 5197 w/o Exh. Packing ----- OP 303-7 1955-1957 LH & RH Dip Stick/ Thin & Thick Front Seals Universal Set</p>	<p>MS 303-1 1955-57 9617</p>	<p>EMS 303-5 1955-1957 9275</p>	<p>VS 303-5 1955-1957 12869 ----- VS 303-5A 1955-1957 Cork 7/32" Thick 12869AC</p>	<p>TCS 303-3 1955-1957 5124-1</p>	<p>RS 303-1 1955-1957 Rope 5155</p>	<p>SS 303-3 1955-1957 O-Ring 5112</p>
<p>OP 303-3 1979 5197-5 ----- OP 303-5 1980-1982 30410 ----- OP 303-7 1979 LH & RH Dip Stick/ Thin & Thick Front Seals Universal Set -----</p>	<p>MS 303-2 1979-1982 90314-2</p>	<p>EMS 303-5 1979-1982 9275</p>	<p>VS 303-5 1979-1982 12869 ----- VS 303-5A 1979-1982 Cork 7/32" Thick 12869AC</p>	<p>TCS 303-5 1979-1982 45121</p>	<p>RS 303-5 1979-1982 2 Pc. Silicone 40013</p>	<p>SS 303-3 1979-1982 O-Ring 5112 ----- SS 303-6 1981-1982 INTAKE 72527 ----- SS 303-8 1981-1982 EXHAUST 72526</p>
<p>OP 303-2 1957-1967 5197-2 ----- OP 303-7 1957-1967 LH & RH Dip Stick/ Thin & Thick Front Seals -----</p>	<p>MS 303-1 1957-1967 9617</p>	<p>EMS 303-5 1957-1967 9275</p>	<p>VS 303-5 1957-1967 12869 ----- VS 303-5A 1957-1967 Cork 7/32" Thick 12869AC</p>	<p>TCS 303-3 1957-1967 5124-1</p>	<p>RS 303-1 Rope 1957-1958 5155 ----- RS 303-5 1959-67 2 Pc. Silicone 40013</p>	<p>SS 303-3 1957-67 O-Ring 5112</p>



ENGINE INFORMATION	HEAD GASKET	HEAD KIT With <u>NO</u> Valve Stem Seals	HEAD SET With Valve Stem Seals	KIT SET	SHORT BLOCK SET
--------------------	-------------	--	--------------------------------------	---------	-----------------

GM Trucks, Mini-vans, & SUVs: V8

4.8L 293 OHV V8 Chevrolet Engine, 16 Vlv GEN III 1999-2008 VIN V 1999-2008 (VORTEC)	HG 320-1 1999-2001 9292 ----- HG 320-6 2002-2008 26191 Head Bolts HB 320-1 1999-2004 1st Design (2 Required) 72173 ----- HB 320-3 2004-2008 2nd Design (2 Required) 72220	HK 320-1 1999-2001 9292 ----- HK 320-6 2002-2008 26191	HS 320-1 1999-01 1st Design .492 O.D. Guide Positive Seal 9292 ----- HS 320-2 2001 2nd Design .715 O.D. Guide Top Hat Design 9292-1 ----- HS 320-4 2004-2008 26191-1 ----- HS 320-6 2002-03 2nd Design .715 O.D. Guide Top Hat Design 26191	KS 320-1 1999-01 1st Design .492 O.D. Guide Positive Seal 9292 ----- KS 320-2 2001 2nd Design .715 O.D. Guide Top Hat Design 9292-1 ----- KS 320-4 2004-2008 26191-1 ----- KS 320-6 2002-03 2nd Design .715 O.D. Guide Top Hat Design 26191	ER 320-1 1999-2001 9292 ----- ER 320-6 2002-2005 26191
--	---	--	--	--	--



OIL PAN SET	INTAKE MANIFOLD SET	EXHAUST MANIFOLD SET	VALVE COVER SET	TIMING COVER SET	REAR SEAL SET	VALVE STEM SEAL SET
-------------	---------------------	----------------------	-----------------	------------------	---------------	---------------------

GM Trucks, Mini-vans, & SUVs: V8

<p>OP 320-1 1999-2008 30693</p>	<p>MS 320-1 1999-2003 silicone 92211 ----- MS 320-4 2004-2008 SUPER DUTY PTFE 92211</p> <p>THROTTLE BODY TB 320-2 1999-2008 61070</p>	<p>EMS 320-2 1999-2008 92467</p>	<p>VS 320-4 1999-2008 50504</p>	<p>TCS 320-1 1999-2008 45964</p>	<p>RS 320-1 1999-2008 Radial 40640</p>	<p>SS 320-1 1999-2001 1st Design .492 O.D. Guide Positive Type 70945 ----- SS 320-4 2001-2004 2nd. Design .715 O.D. Guide Top Hat Type 71039</p>
---	---	--	---	--	--	--



ENGINE INFORMATION	HEAD GASKET	HEAD KIT With <u>NO</u> Valve Stem Seals	HEAD SET With Valve Stem Seals	KIT SET	SHORT BLOCK SET
--------------------	-------------	--	--------------------------------------	---------	-----------------

GM Trucks, Mini-vans, & SUVs: V8

<p>5.0L 305 OHV V8 Chevrolet Engine, 16 Vlv 1976-2002</p> <p>VIN F 1981-1986 VIN G 1980-1981, 1984-1987 VIN H 1979-1996 VIN M 1996-2002 (VORTEC) VIN Q 1976 VIN U 1976-1979</p>	<p>HG 303-6 1976-2002 8510</p> <p>Head Bolt Set HB 303-5 1976-2002 72856</p>	<p>HK 303-6 1976-1986 8510 8510-1 -----</p> <p>HK 303-8 1987-1995 8510-4 -----</p> <p>HK 303-18 1996-2002 Plastic Int. 8510-6</p>	<p>HS 303-6 1976-1986 8510 8510-1 -----</p> <p>HS 303-8 1987-1995 8510-4 -----</p> <p>HS 303-18 1996-2002 Plastic Int. 8510-6</p>	<p>KS 303-6 1976-1986 8510 8510-1 VJ -----</p> <p>KS 303-8 1987-1995 8510-4 VN -----</p> <p>KS 303-18 1996-2002 Plastic Int. 8510-6</p>	<p>ER 303-6 1976-1986 8510 8510-1 -----</p> <p>ER 303-8 1987-1995 8510-4 -----</p> <p>ER 303-18 1996-2002 Plastic Int. 8510-6</p>
<p>5.0L 307 OHV V8 Chevrolet Engine, 16 Vlv 1968-73</p> <p>VIN A , B 1970 VIN E 1968-1969 VIN F 1972-1973 VIN H, P 1971 VIN U 1969 VIN X 1973</p>	<p>HG 303-3 1967-1972 7733-2</p> <p>Head Bolt Set HB 303-5 1967-1972 72856</p>	<p>HK 303-3 1968-1973 7733-2</p>	<p>HS 303-3 1968-1973 7733-2</p>	<p>KS 303-3 1968-1973 7733-2</p>	<p>ER 303-3 1968-1973 7733-2</p>

OIL PAN SET	INTAKE MANIFOLD SET	EXHAUST MANIFOLD SET	VALVE COVER SET	TIMING COVER SET	REAR SEAL SET	VALVE STEM SEAL SET
-------------	---------------------	----------------------	-----------------	------------------	---------------	---------------------

GM Trucks, Mini-vans, & SUVs: V8

<p>OP 303-5 1976-1979 5197-5 -----</p> <p>OP 303-6 1980-1984 30410 -----</p> <p>OP 303-7 1976-1979 LH & RH Dip Stick/ Thin & Thick Front Seals -----</p> <p>OP 303-9 1986-2002 1 Pc. Silicone 34500 -----</p> <p>OP 303-10 1976-1985 OPTIONAL 1 Pc Silicone w/Split RM Seal</p>	<p>MS 303--2 1976-1986 2 & 4 Bbl. 90314-2 -----</p> <p>MS 303-7 1987-1995 W/TBI 93317 -----</p> <p>MS 303-11 1996-2002 Upper & Lower 90131 -----</p> <p>MS 303-12 1996-2002 Lower Set 90131-2 -----</p> <p>MS 303-15 1996-2002 Upper & Lower w/Valve Cover Set 98000</p> <p>THROTTLE BODY TB 303-2 1987-1990 60759 -----</p> <p>TB 303-3 1991-1995 60903 -----</p> <p>TB 303-4 1996-2002 61036</p>	<p>EMS 303-5 1976-1995 9275 -----</p> <p>EMS 303-8 1996-2002 94054</p>	<p>VS 303-5 1976-1986 12869 -----</p> <p>VS 303-6 1987-2002 Flat Silicone Set 50088 -----</p> <p>VS 303-8 1987-2002 Rubber Coated K-Cork w/Steel Core Set HD 50088</p>	<p>TCS 303-5 1976-1995 45121 -----</p> <p>TC 303-8 Plastic Cover Assy. w/o Sensor Hole 1986-2002 Must be used w/ Oil Pan -----</p> <p>TC 303-10 Plastic Cover Assy. with Sensor Hole 1986-2002 Must be used w/ Oil Pan</p>	<p>RS 303-5 1976-1985 2 Pc. Silicone 40013 -----</p> <p>RS 303-8 1985-1996 Radial Seal 40520 -----</p> <p>RS 303-10 1996-2002 Radial Seal PTFE 40656 40515</p>	<p>SS 303-3 1976-1980 O-RING 5112 -----</p> <p>SS 303-6 1981-85 INTAKE SET 72527 -----</p> <p>SS 303-8 1981-1995 EXHAUST SET 72526 -----</p> <p>SS 303-7 1981-1995 EXHAUST SET HEAVY DUTY ENG. 72883 -----</p> <p>SS 303-10 1996-2002 INT. & EXH SET 72861</p>
<p>OP 303-2 1968-1973 5197-2 -----</p> <p>OP 303-7 1968-1973 LH & RH Dip Stick/ Thin & Thick Front Seals -----</p>	<p>MS 303-2 1968-1973 90314-2</p>	<p>EMS 303-5 1968-1973 9275</p>	<p>VS 303-5 1968-1973 12869 -----</p> <p>VS 303-5A 1968-1973 Cork 7/32" Thick 12869AC</p>	<p>TCS 303-3 1968-1973 5124-1</p>	<p>RS 303-5 1968-1973 2 Pc. Silicone 40013</p>	<p>SS 303-3 1968-1973 O-Ring 5112</p>



ENGINE INFORMATION	HEAD GASKET	HEAD KIT With <u>NO</u> Valve Stem Seals	HEAD SET With Valve Stem Seals	KIT SET	SHORT BLOCK SET
--------------------	-------------	--	--------------------------------------	---------	-----------------

GM Trucks, Mini-vans, & SUVs: V8

<p>5.3L 325 OHV V8 Chevrolet Engine, 16 Vlv LQ-9 GEN III 1999-2008</p> <p>VIN B 2005-2007 H.O. (VORTEC) VIN M 2005-2008 (VORTEC) VIN P 2003-2005 (VORTEC) VIN T 1999-2008 (VORTEC) VIN Z 2002-2008 (VORTEC FLEX FUEL)</p>	<p>HG 320-1 1999-2001 9292 -----</p> <p>HG 320-5 2002-2008 VIN P, T, Z 26191 -----</p> <p>HG 320-6 2005-2008 VIN B, M 26190</p> <p>Head Bolts HB 320-1 1999-2004 1st Design 2 Required 72173 -----</p> <p>HB 320-3 .2004-2008 2nd Design 2 Required 72220</p>	<p>HK 320-1 1999-2001 9292 -----</p> <p>HK 320-5 2002-2005 VIN P, T, Z 26191 -----</p> <p>HK 320-6 2005-2008 VIN B, M 26190</p>	<p>HS 320-1 1999-2001 .492 O.D. Guide 1st Design Positive seal 9292 -----</p> <p>HS 320-2 2001 2nd Design .715 O.D. Guide Top Hat Design 9292-1 -----</p> <p>HS 320-4 2002-2003 VIN Z 2004-2008 VIN P, T, Z 26191-1 -----</p> <p>HS 320-6 2002-2003 2nd Design .715 O.D. Guide Top Hat Design VIN P, T 26191 -----</p> <p>KS 320-8 2005-2007 VIN B H.O. 2005-2008 VIN M 26190-2</p>	<p>KS 320-1 1999-2001 .492 O.D. Guide 1st Design Positive seal 9292 -----</p> <p>KS 320-2 2001 2nd Design .715 O.D. Guide Top Hat Design 9292-1 -----</p> <p>KS 320-4 2002-2003 VIN Z 2004-2008 VIN P, T, Z 26191-1 -----</p> <p>KS 320-6 2002-2003 2nd Design .715 O.D. Guide Top Hat Design VIN P, T 26191 -----</p> <p>KS 320-8 2005-2007 VIN B H.O. 2005-2008 VIN M 26190-2</p>	<p>ER 320-1 1999-2001 9292 -----</p> <p>ER 320-6 2002-2005 26191</p>
<p>5.3L 327 OHV V8 Chevrolet Engine, 16 Vlv 1962-69</p> <p>VIN E 1968</p>	<p>HG 303-3 1962-1969 7733-2</p> <p>Head Bolt Set HB 303-5 SET (2 REQ'D) 1962-1969 72856</p>	<p>HK 303-3 1962-1969 7733-2</p>	<p>HS 303-3 1962-1969 7733-2</p>	<p>KS 303-3 1962-1969 7733-2</p>	<p>ER 303-3 1962-1969 7733-2</p>



OIL PAN SET	INTAKE MANIFOLD SET	EXHAUST MANIFOLD SET	VALVE COVER SET	TIMING COVER SET	REAR SEAL SET	VALVE STEM SEAL SET
-------------	---------------------	----------------------	-----------------	------------------	---------------	---------------------

GM Trucks, Mini-vans, & SUVs: V8

<p>OP 320-1 1999-2008 30693</p>	<p>MS 320-1 1999-2001 & 2002-2003 VIN P, T Silicone 92211 ----- MS 320-4 2004-2008 SUPER DUTY PTFE 92211</p> <p>THROTTLE BODY TB 320-2 1099-2008 VIN B, P,, T, Z w/MFI 61070 ----- TB 320-4 2005 VIN M w/MFI 61454 ----- TB 320-6 2006-2008 VIN M w/MFI 61469</p>	<p>EMS 320-2 1999-2008 92467</p>	<p>VS 320-4 1999-2008 50504</p> <p>GROMMET SET VCG 320-5 1999-2008 70945</p>	<p>TCS 320-1 1999-2008 USE w/OP 45964</p>	<p>RS 320-1 1999-2008 40640</p>	<p>SS 320-1 1999-2001 .492 O.D. Guide 1st Design Positive Seal 70945 ----- SS 320-4 2001-2004 .715 O.D. Guide 2nd. Design Top Hat Design 71039</p>
<p>OP 303-2 1962-1969 5197-2 ----- OP 303-7 1962-1969 LH & RH Dip Stick/ Thin & Thick Front Seals</p>	<p>MS 303-2 1962-1969 90314-2</p>	<p>EMS 303-5 1962-1969 9275</p>	<p>VS 303-5 1962-1969 12869 ----- VS 303-5A 1962-1969 Cork 7/32" Thick 12869AC</p>	<p>TCS 303-3 1962-1969 5124-1</p>	<p>RS 303-5 1962-1969 2 Pc. Silicone 40013</p>	<p>SS 303-3 1962-1969 O-Ring 5112</p>

OIL PAN SET	INTAKE MANIFOLD SET	EXHAUST MANIFOLD SET	VALVE COVER SET	TIMING COVER SET	REAR SEAL SET	VALVE STEM SEAL SET
-------------	---------------------	----------------------	-----------------	------------------	---------------	---------------------

GM Trucks, Mini-vans, & SUVs: V8

<p>OP 303-3 1969-1974 5197-2 -----</p> <p>OP 303-5 1975-1979 5197-5 -----</p> <p>OP 303-7 1968-1979 LH & RH Dip Stick/ Thin & Thick Front Seals Universal Set -----</p> <p>OP 303-10 1980-1985 1 Pc. Silicone 30410 -----</p> <p>OP 303-9 1986-2002 1 Pc. Silicone 34500</p>	<p>MS 303-2 1969-1973 2 & 4 Bbl. 1974 2 Bbl. -----</p> <p>1975 2 & 4 Bbl. 1977 2 Bbl. 1978 2 & 4 Bbl. EXC. HD 1979-1986 2 & 4 Bbl. 1987-1988 4 Bbl. 90314-2 -----</p> <p>MS 303-5 1974 4 Bbl. 1976 2 & 4 Bbl. 1977 4 Bbl. 1978 2 & 4 Bbl. HD 90314-3 -----</p> <p>MS 303-7 1987-1995 W/ TBI 93317 -----</p> <p>MS 303-11 1996-2002 Upper & Lower Set 90131 -----</p> <p>MS 303-12 1996-2002 Lower Set 90131-2 -----</p> <p>MS 303-18 1996-2002 w/CPI Upper set 90269 -----</p> <p>MS 303-15 1996-2002 Upper & Lower Int w/ Valve Cvr 98000</p>	<p>EMS 303-5 1969-1995 9275 -----</p> <p>EMS 303-8 1996-2002 94054</p>	<p>VS 303-5 1969-1986 12869 -----</p> <p>VS 303-5A 1969-1986 Cork 7/32" Thick 12869AC -----</p> <p>VS 303-6 1987-2002 Flat Silicone 50088 -----</p> <p>VS 303-8 1987-2002 Rubber Coated K-Cork w/Steel Core Set HD 50088</p>	<p>TCS 303-3 1969-1974 5124-1 -----</p> <p>TCS 303-5 1975-1985 45121 -----</p> <p>TC 303-8 Plastic Cover Assy. w/o Sensor Hole 1986-2002 Must be used w/ Oil Pan -----</p> <p>TC 303-10 Plastic Cover Assy. with Sensor Hole 1986-2002 Must be used w/ Oil Pan</p>	<p>RS 303-5 1969-1985 2 Pc. Silicone 40013 -----</p> <p>RS 303-8 1986-1995 Radial 40520 -----</p> <p>RS 303-10 1996-2002 Radial 40656</p>	<p>SS 303-3 1969-1980 O-Ring 5112 -----</p> <p>SS 303-6 1981-85 Intake 72527 -----</p> <p>SS 303-8 1981-1995 Exhaust 72526 -----</p> <p>SS 303-7 1981-1995 Exhaust Heavy Duty Eng. 72883 -----</p> <p>SS 303-10 1996-2002 Int. & Exh 72861</p>
<p>OP 348-5 1958-1965 13190</p>	<p>MS 348-5 1958-1965 9459</p>	<p>EMS 348-5 1958-1965 9908</p>	<p>VS 348-5 1958-1965 13199</p>	<p>TCS 348-5 1958-1965 11727-1</p>	<p>RS 348-5 1958-1965 40096</p>	<p>SS 303-3 1958-1965 O-Ring 5112</p>



ENGINE INFORMATION	HEAD GASKET	HEAD KIT With <u>NO</u> Valve Stem Seals	HEAD SET With Valve Stem Seals	KIT SET	SHORT BLOCK SET
--------------------	-------------	--	--------------------------------------	---------	-----------------

GM Trucks, Mini-vans, & SUVs: V8

<p>5.7L 350 OHV LPG V8 Chevrolet Engine, 16 Vlv 1969-76</p> <p>VIN W 1973-76 (LPG)</p>	<p>HG 303-3 1969-1976 7733-2</p> <p>Head Bolt Set HB 303-5 1969-1976 72856</p>	<p>HK 303-3 1969-1976 7733-2</p>	<p>HS 303-3 1969-1976 7733-2</p>	<p>KS 303-3 1969-1976 7733-2</p>	<p>ER 303-3 1969-1976 7733-2</p>
<p>5.7L 350 OHV Diesel V8 Oldsmobile Engine, 16 Vlv 1978-84</p> <p>VIN N 1983-1984 VIN Z 1978-1981</p>	<p>HG 608-2 1978-1984 8963 ----- HG 608-4 1978-1984 .010 Thicker 8716-1</p>	<p>HKX 608-2 1978-1981 External EGR 1 Stud Air Cleaner HG N/I 8716 ----- HKX 608-5 1981-1984 Internal EGR 2 Stud Air Cleaner HG N/I 8716-2</p>	<p>HSX 608-2 1978-1981 External EGR 1 Stud Air Cleaner HG N/I 8716 ----- HSX 608-5 1981-1984 Internal EGR 2 Stud Air Cleaner HG N/I 8716-2</p>	<p>KSX 608-2 1978-1981 External EGR 1 Stud Air Cleaner HG N/I 8716 ----- KSX 608-5 1981-1984 Internal EGR 2 Stud Air Cleaner HG N/I 8716-2</p>	<p>ERX 608-2 1978-1981 External EGR 1 Stud Air Cleaner HG N/I 8716 ----- ERX 608-5 1981-1984 Internal EGR 2 Stud Air Cleaner HG N/I 8716-2</p>
<p>6.0L 364 OHV V8 Chevrolet Engine, 16 Vlv GEN III 1999-2005</p> <p>VIN H 2005-2008 (VORTEC) VIN N 2002-2007 (VORTEC) VIN U 1999-2008 (VORTEC)</p>	<p>HG 320-3 1999-2000 9199 ----- HG 320-7 2001-2008 Stainless Steel 26192</p> <p>Head Bolts HB 320-1 1999-2004 1st Design (2 Required) 72173 ----- HB 320-3 2004-2008 2nd Design (2 Required) 72220</p>	<p>HK 320-3 1999-2000 9199 ----- HK 320-7 2001-2008 26192-1-2-4</p>	<p>HS 320-3 1999-2000 .492 O.D. GUIDE 1st Design VIN U 9199 ----- HS 320-5 2001-2003 715 O.D. GUIDE 2nd Design Top Hat Seal VIN U 26192 ----- HS 320-7 2001 .715 O.D. GUIDE Top Hat Seal VIN U 26192-1 ----- HS 320-8 2004-2008 VIN N & U 26192-2 ----- HS 320-10 2005-2008 VIN H 26192-4</p>	<p>KS 320-3 1999-2000 .492 O.D. GUIDE 1st Design VIN U 9199 ----- KS 320-5 2001-2003 715 O.D. GUIDE 2nd Design Top Hat Seal VIN U 26192 ----- KS 320-7 2001 .715 O.D. GUIDE Top Hat Seal VIN U 26192-1 ----- KS 320-8 2004-2008 VIN N & U 26192-2 ----- KS 320-10 2005-2008 VIN H 26192-4</p>	<p>ER 320-3 1999-2003 9199</p>



OIL PAN SET	INTAKE MANIFOLD SET	EXHAUST MANIFOLD SET	VALVE COVER SET	TIMING COVER SET	REAR SEAL SET	VALVE STEM SEAL SET
-------------	---------------------	----------------------	-----------------	------------------	---------------	---------------------

GM Trucks, Mini-vans, & SUVs: V8

<p>OP 303-3 1969-1976 5197-2 ----- OP 303-7 1969-1976 LH & RH Dip Stick/ Thin & Thick Front Seals Universal Set</p>	<p>MS 303-2 1969-1976 90314-2</p>	<p>EMS 303-5 1969-1976 9275</p>	<p>VS 303-5 1969-1976 12869 ----- VS 303-5A 1969-1976 Cork 7/32" Thick 12869AC</p>	<p>TCS 303-3 1969-1976 5124-1</p>	<p>RS 303-5 1969-1976 40013</p>	<p>SS 303-3 1969-1976 O-Ring 5112</p>
<p>OP 605-5 1978-1984 K-Cork 30471</p>	<p>MS 608-2 1978-1981 External EGR 1 Stud Air Cleaner 9947-2 ----- MS 308-5 1981-1984 Internal EGR 2 Stud Air Cleaner 92328</p>	<p>EMS 603-3 1978-1984 90021</p>	<p>VS 605-5 1978-1984 13403</p>	<p>TCS 605-3 1978-1984 13417</p>	<p>RS 109-5 1978-1984 Rope 13044-2 ----- RS 512-5 1978-1984 2 Pc Rubber 40032</p>	<p>SS 605-5 1978-1984 70393</p>
<p>OP 320-1 1999-2008 30693</p>	<p>MS 320-1 1999-2003 silicone 92211 ----- MS 320-4 2004-2008 SUPER DUTY PTFE 92211 THROTTLE BODY TB 320-2 1999-2008 61070 ----- TB 320-4 2005 VIN H w/MFI 61454 ----- TB 320-6 2006-2008 VIN H w/MFI 61468</p>	<p>EMS 320-2 1999-2008 92467</p>	<p>VS 320-4 1999-2008 50504 ----- GROMMET SET VCG 320-5 1999-2008 72233</p>	<p>TCS 320-1 1999-2008 45964</p>	<p>RS 320-1 1999-2008 PTFE 40640</p>	<p>SS 320-2 1999-01 .492 O.D. GUIDE 1st Design 70945 ----- SS 320-4 2001-2008 .715 O.D. GUIDE 2nd Design 71039</p>



ENGINE INFORMATION	HEAD GASKET	HEAD KIT With <u>NO</u> Valve Stem Seals	HEAD SET With Valve Stem Seals	KIT SET	SHORT BLOCK SET
--------------------	-------------	--	--------------------------------------	---------	-----------------

GM Trucks, Mini-vans, & SUVs: V8

<p>6.0L 366 OHV V8 Chevrolet Truck Engine, 16 Vlv 1966-98</p> <p>LIGHT DUTY 1966-1967 MEDIUM DUTY 1966-1998</p>	<p>HG 309-3 1966-1990 8180-2 ----- HG 309-5 1991-1995 8523-1</p> <p>Head Bolts HB 309-5 GS33287</p>	<p>HK 309-2 1966-1985 Exc. H5D Emission 8180-5 ----- HK 309-3 1985 w/H5D Emission 1986-1990 Medium Duty 8180-6 ----- HK 309-9 1986-1990 8523-3</p>	<p>HS 309-2 1966-1985 Exc. H5D Emission 8180-5 ----- HS 309-3 1985 w/H5D Emission 1986-1990 Medium Duty 8180-6 ----- HS 309-9 1986-1990 8523-3</p>	<p>KS 309-2 1966-1985 Exc. H5D Emission 8180-5 ----- KS 309-3 1985 w/H5D Emission 1986-1990 Medium Duty 8180-6 ----- KS 309-9 1986-1990 8523-3</p>	<p>ER 309-2 1966-1985 Exc. H5D Emission 8180-5 ----- ER 309-3 1985 w/H5D Emission 1986-1990 Medium Duty 8180-6 ----- ER 309-9 1986-1990 8523-3</p>
<p>6.2L 379 OHV Diesel V8 Chevrolet Engine, 16 Vlv 1982-93</p> <p>VIN C 1983-92 (L/D) VIN J 1982-93 (H/D)</p>	<p>HG 308-5 1982-1993 8726 ----- HG 308-6 1982-1993 .010 THICKER 9128 ----- Head Bolts HB 308-5 72724</p>	<p>HKX 308-5 1982-1993 Light Duty w/o HG 8726 ----- HKX 308-6 1982-1993 Heavy Duty w/o HG 8726-1</p>	<p>HSX 308-5 1982-1993 Light Duty w/o HG 8726 ----- HSX 308-6 1982-1993 Heavy Duty w/o HG 8726-1</p>	<p>KSX 308-5 1982-1993 Light Duty w/o HG 8726 ----- KSX 308-6 1982-1993 Heavy Duty w/o HG 8726-1</p>	<p>ERX 308-5 1982-1993 Light Duty w/o HG 8726 ----- ERX 308-6 1982-1993 Heavy Duty w/o HG 8726-1</p>
<p>6.5L 395 OHV Diesel V8 Chevrolet Engine, 16 Vlv 1994-99</p> <p>VIN P 1994-1995 VIN Y 1994-1999 (H.O.) VIN F 1992-1998 (H.O.) VIN S 1994-1998</p>	<p>HG 308-9 1994-1999 9701 ----- HG 308-10 1994-1999 .010 THICKER 9521 ----- Head Bolts HB 308-5 72724</p>	<p>HK 308-7 1994-1999 w/Std. H.G. ----- HKX 308-8 1994-1999 w/o H.G. 8726</p>	<p>HS 308-7 1994-1999 w/Std. H.G. ----- HSX 308-8 1994-1999 w/o H.G. 8726</p>	<p>KS 308-7 1994-1999 w/Std. H.G. ----- KSX 308-8 1994-1999 w/o H.G. 8726</p>	<p>ER 308-7 1994-1999 w/Std. H.G. ----- ERX 308-8 1994-1999 w/o H.G. 8726</p>
<p>6.5L 395 OHV Turbo Diesel V8 Chevrolet Engine, 16 Vlv 1992-2005</p>	<p>HG 308-9 1992-2005 9701 ----- HG 308-10 1992-2005 .010 THICKER 9521</p>	<p>HK 308-7 1992-2005 w/Std. H.G. ----- HKX 308-8 1992-2005 w/o H.G. 8726</p>	<p>HS 308-7 1992-2005 w/Std. H.G. ----- HSX 308-8 1992-2005 w/o H.G. 8726</p>	<p>KS 308-7 1992-2005 w/Std. H.G. ----- KSX 308-8 1992-2005 w/o H.G. 8726</p>	<p>ER 308-7 1992-2005 w/Std. H.G. ----- ERX 308-8 1992-20054 w/o H.G. 8726</p>



OIL PAN SET	INTAKE MANIFOLD SET	EXHAUST MANIFOLD SET	VALVE COVER SET	TIMING COVER SET	REAR SEAL SET	VALVE STEM SEAL SET
-------------	---------------------	----------------------	-----------------	------------------	---------------	---------------------

GM Trucks, Mini-vans, & SUVs: V8

<p>OP 309-3 1966-1990 Cork/Rubber 30061-1 ----- OP 309-5 1991-1998 1 Pc. Silicone 34407</p>	<p>MS 309-3 1966-1990 Exc. LPG 90240-3 ----- MS 309-4 1991-1998 Med Duty 95254</p>	<p>EMS 309-3 1966-1998 90206 ----- EMS 309-5 1966-1998 Heavy Duty 90502</p>	<p>VS 309-3 1966-1985 Exc. H5D Emission 30055 ----- VS 309-5 1985 w/H5D Emission 1986-1990 5/16 Cork Rubber 50090 ----- VS 309-8 1986-1990 Silicone 50090 ----- VS 309-6 1991-1998 Silicone Bead 50388</p>	<p>TCS 309-3 1966-1996 1 st Design 10-Bolt Cover Use w/OP After 1990 45060 ----- TCS 309-6 1996-1998 2nd Design 6 Bolt Cover Use w/OP 45969</p>	<p>RS 309-5 1966-1990 2 Pc Silicone 40096-1 ----- RS 309-8 1991-1998 Radial Viton 40622</p>	<p>SS 309-5 1966-1990 71152 ----- SS 309-8 1991-1998 72823</p>
<p>OP 308-5 1982-1991 34400 ----- OP 308-6 1992-1993 34406</p>	<p>MS 308-4 1982-1993 LIGHT DUTY 91585 ----- MS 308-5 1982-1993 HEAVY DUTY 91586</p>	<p>EMS 308-5 1982-1993 91587</p>	<p>VS 308-5 1982-1993 50228</p>	<p>TCS 308-5 1982-1993 45554</p>	<p>RS 303-8 1982-1991 2 Pc. Set 40520 ----- RS 308-6 1992-1993 Radial 40604</p>	<p>SS 303-3 1982-1993 O-Ring 5112 ----- SS 308-5 1988-1993 Exh. Exc. H.D. 1988-1990 72711</p>
<p>OP 308-6 1994-1999 34406</p>	<p>MS 308-4 1994-1999 Lower Set 91585</p>	<p>EMS 308-5 1994-1999 91587</p>	<p>VS 308-5 1994-1999 50228</p>	<p>TCS 308-5 1994-1999 45554</p>	<p>RS 308-6 1994-1999 Radial 40604</p>	<p>SS 303-3 1994-1999 O-Ring 5112 ----- SS 308-5 1994-1999 Exh. Positive 72711</p>
<p>OP 308-6 1992-2005 34406</p>	<p>MS 308-4 1992-2005 Lower Set 91585 ----- MS 308-6 1992-2005 Upper Plenum 90176-1</p>	<p>EMS 308-5 1992-2005 91587</p>	<p>VS 308-5 1992-2005 50228</p>	<p>TCS 308-5 1992-2005 45554</p>	<p>RS 308-6 1992-2005 Radial 40604</p>	<p>SS 303-3 1992-2005 O-RING 5112 ----- SS 308-5 1992-2005 Exh. Positive 72711</p>



ENGINE INFORMATION	HEAD GASKET	HEAD KIT With <u>NO</u> Valve Stem Seals	HEAD SET With Valve Stem Seals	KIT SET	SHORT BLOCK SET
--------------------	-------------	--	--------------------------------------	---------	-----------------

GM Trucks, Mini-vans, & SUVs: V8

<p>6.5L 396 OHV V8 GEN IV Chevrolet L/D Truck Engine, 16 Vlv 1966-69</p> <p>VIN E 1968-1969 VIN Y 1968-1969</p>	<p>HG 309-3 1966-1969 8180-2</p>	<p>HK 309-3 1966-1969 8180-5</p>	<p>HS 309-3 1966-1969 8180-5</p>	<p>KS 309-3 1966-1969 8180-9</p>	<p>ER 309-3 1966-1969 8180-9</p>
<p>6.6L 400 OHV V8 Chevrolet Engine, 16 Vlv Small Block 1970-80</p> <p>VIN E 1972 VIN K 1970 VIN M 1975 VIN R 1972-1980 VIN U 1973-1976 VIN X 1980</p>	<p>HG 303-4 1970-1980 8364</p>	<p>HK 303-4 1970-1980 8364-3</p>	<p>HS 303-4 1970-1980 8364-3</p>	<p>KS 303-4 1970-1980 8364-3</p>	<p>ER 303-4 1970-1980 8364-3</p>
<p>6.6L 402 OHV V8 GEN IV Chevrolet Engine, 16 Vlv Big Block 1970-72</p> <p>VIN E 1970-1972 VIN K 1971 VIN S 1972 VIN U 1972</p>	<p>HG 309-3 1970-1972 8180-2</p>	<p>HK 309-3 1970-1972 8180-5</p>	<p>HS 309-3 1970-1972 8180-5</p>	<p>KS 309-3 1970-1972 8180</p>	<p>ER 309-3 1970-1972 8180</p>
<p>6.6L 403 OHV V8 Oldsmobile Engine, 16 Vlv 1977-78</p> <p>VIN K 1977-1978</p>	<p>HG 603-6 1977-1978 8507</p>	<p>HK 603-6 1977-1978 Valley Pan N/I 8507</p>	<p>HS 603-6 1977-1978 Valley Pan N/I 8507</p>	<p>KS 603-6 1977-1978 Valley Pan N/I 8507</p>	<p>ER 603-6 1977-1978 Valley Pan N/I 8507</p>
<p>6.7L 409 OHV V8 Chevrolet L/D Truck Engine, 16 Vlv 1962-1965</p>	<p>HG 348-5 1962-1965 Steel Shim 8007</p>	<p>HK N/A</p>	<p>HS 348-5 1962-1965 Steel Shim 8007-3</p>	<p>KS 348-5 1962-1965 Steel Shim 8007-3</p>	<p>ER 348-5 1962-1965 Steel Shim 8007-3</p>

OIL PAN SET	INTAKE MANIFOLD SET	EXHAUST MANIFOLD SET	VALVE COVER SET	TIMING COVER SET	REAR SEAL SET	VALVE STEM SEAL SET
-------------	---------------------	----------------------	-----------------	------------------	---------------	---------------------

GM Trucks, Mini-vans, & SUVs: V8

OP 309-3 1966-1969 30061-1	MS 309-2 Exc. LPG 1966-1969 90240-2 ----- MS 309-6 LPG 1966-1969 9032	EMS 309-3 1966-1969 90206	VS 309-3 1966-1969 30055 ----- VS 309-5 1966-1969 Special Hi-Perf 5/16" C/R	TCS 309-3 1966-1969 45060	RS 309-5 1966-1969 40096-1	SS 309-5 1966-1969 71152
OP 303-5 1970-1980 5197-5	MS 303-2 1970-1980 Exc. 78 20-2500 & 30-3500 Series 90314 ----- MS 303-5 1978 20-2500 & 30-3500 Series 90314-3	EMS 303-5 1970-1980 9275	VS 303-5 1970-1980 12869	TCS 303-5 1970-1980 45121	RS 303-5 1970-1980 40013	SS 303-3 1970-1980 O-Ring 5112
OP 309-3 1970-1972 30061-1	MS 309-2 Exc. LPG 1970-1972 90240-2 ----- MS 309-7 LPG 1970-1972 90323	EMS 309-3 1970-1972 90206	VS 309-3 1970-1972 30055 ----- VS 309-5 1970-1972 Special Hi-Perf 5/16" C/R	TCS 309-3 1970-1972 45060	RS 309-5 1970-1972 40096-1	SS 309-5 1970-1972 71152
OP 603-3 1977-1978 13419	VP 603-4 1977-1978 96027	EMS 603-3 1977-1978 90021	VS 605-5 1977-1978 13403	TCS 603-3 1977-1978 13417	RS 109-5 ROPE 1977-1978 13044-3 ----- RS 512-5 2 Pc. Rubber 1977-1978 40032	SS 605-5 1977-1978 70393
OP 348-5 1962-1965 13190	MS 348-5 1962-1965 9459	EMS 348-5 1962-1965 9908	VS 348-5 1962-1965 13199	TCS 348-5 1962-1965 11727-1	RS 348-5 1962-1965 40096	SS 303-5 1962-1965 O-Ring 5112



ENGINE INFORMATION	HEAD GASKET	HEAD KIT With <u>NO</u> Valve Stem Seals	HEAD SET With Valve Stem Seals	KIT SET	SHORT BLOCK SET
--------------------	-------------	--	--------------------------------------	---------	-----------------

GM Trucks, Mini-vans, & SUVs: V8

<p>7.0L 427 OHV V8 Chevrolet Engine, 16 Vlv 1968-1998</p> <p>M/D TRUCK EXC. LP GAS</p>	<p>HG 309-3 1968-1973 8180-2 -----</p> <p>HG 309-5 1974-1990 8523-1 -----</p> <p>HG 309-8 1991-1998 4878</p>	<p>HK 309-3 1968-1973 8180-5 -----</p> <p>HK 309-5 1974-1985 w/o 85 H5D Emissions 8523 -----</p> <p>HK 309-6 1985 w/H5D Emissions & 1986-1990 8523-1 -----</p> <p>HK 309-9 1991-1998 8523-3</p>	<p>HS 309-3 1968-1973 8180-5 -----</p> <p>HS 309-5 1974-1985 w/o 85 H5D Emissions 8523 -----</p> <p>HS 309-6 1985 w/H5D Emissions & 1986-1990 8523-1 -----</p> <p>HS 309-9 1991-1998 8523-3</p>	<p>KS 309-3 1968-1973 8180-5 -----</p> <p>KS 309-5 1974-1985 w/o 85 H5D Emissions 8523 -----</p> <p>KS 309-6 1985 w/H5D Emissions & 1986-1990 8523-1 -----</p> <p>KS 309-9 1991-1998 8523-3</p>	<p>ER 309-3 1968-1973 8180-5 -----</p> <p>ER 309-5 1974-1985 w/o 85 H5D Emissions 8523 -----</p> <p>ER 309-6 1985 w/H5D Emissions & 1986-1990 8523-1 -----</p> <p>ER 309-9 1991-1998 8523-3</p>
<p>7.4L 454 OHV V8 GEN IV, V Chevrolet Engine, 16 Vlv 1970-2000</p> <p>VIN J 1996-2000 VIN L 1973-75 VIN N 1987-95, VIN S 1976-79 VIN V 1972 VIN W 1972 & 1980-89 VIN Y 1973-78 VIN Z 1973-75</p>	<p>HG 309-3 GEN IV 1970-1979 8180-2 -----</p> <p>HG 309-5 1980-1995 8523-1 -----</p> <p>HG 309-8 1996-2000 9502</p>	<p>HK 309-3 1970-1979 8180-5 -----</p> <p>HK 309-5 1980-1985 w/o 85 H5D Emissions 8523 -----</p> <p>HK 309-6 1985 W/H5D Emissions & 1986-1990 8523-1 -----</p> <p>HK 309-9 1991-1995 8523-2 -----</p> <p>HK 309-10 1996-2000 9520</p>	<p>HS 309-3 1970-1979 8180-5 -----</p> <p>HS 309-5 1980-1985 W/O 85 H5D Emissions 8523 -----</p> <p>HS 309-6 1985 W/H5D Emissions & 1986-1990 8523-1 -----</p> <p>HS 309-9 1991-1995 8523-2 -----</p> <p>HS 309-10 1996-2000 9520</p>	<p>KS 309-3 1970-1979 8180-9 -----</p> <p>KS 309-5 1980-1985 W/O 85 H5D Emissions 8523 -----</p> <p>KS 309-6 1985 W/H5D Emissions & 1986-1990 8523-1 -----</p> <p>KS 309-9 1991-1995 8523-2 -----</p> <p>KS 309-10 1996-2000 9520</p>	<p>ER 309-3 1970-1979 8180-9 -----</p> <p>ER 309-5 1980-1985 W/O 85 H5D Emissions 8523 -----</p> <p>ER 309-6 1985 W/H5D Emissions & 1986-1990 8523-1 -----</p> <p>ER 309-9 1991-1995 8523-2 -----</p> <p>ER 309-10 1996-2000 9520</p>

OIL PAN SET	INTAKE MANIFOLD SET	EXHAUST MANIFOLD SET	VALVE COVER SET	TIMING COVER SET	REAR SEAL SET	VALVE STEM SEAL SET
-------------	---------------------	----------------------	-----------------	------------------	---------------	---------------------

GM Trucks, Mini-vans, & SUVs: V8

<p>OP 309-3 1968-1990 30061-1 ----- OP 309-5 1 Pc Silicone 1991-1998 34407</p>	<p>MS 309-3 1968-1990 90240-3 ----- MS 309-4 1991-1998 95254</p>	<p>EMS 309-3 1968-1998 90206</p>	<p>VS 309-3 1970-1985 Exc. 85 H5D Emissions 30055 ----- VS 309-8 1986-1990 Silicone 50090 ----- VS 309-6 1991-1998 Silicone Bead 50388</p>	<p>TCS 309-3 1991-1996 1st Design 10 Bolt Cover 45060 ----- TCS 309-6 1996-1998 2nd Design 6 Bolt Cover 45696</p>	<p>RS 309-5 1968-1990 2 Pc. Split Seal 40096-1 ----- RS 309-9 1991-1998 Radial 40622</p>	<p>SS 309-5 1968-1990 71152 ----- SS 309-8 1991-1998 72823</p>
<p>OP 309-3 1970-1990 30061-1 ----- OP 309-5 1 Pc Silicone 1991-2000 34407</p>	<p>MS 309-1 1970-1974 Exc. LPG, W/EGR 1975-78 Exc. LPG & California 1984-1990 90240 ----- MS 309-2 1970-1974 Exc. LPG w/o EGR 1975-1978 Exc. LPG W/California 1979-1983 Exc. LPG 90240-2 ----- MS 309-7 1970-1979 LPG 90323 ----- MS 309-9 1991-1995 95255 ----- MS 309-10 1996-2000 Lower Set 95826 ----- MS 309-12 1996-2000 Plenum set 95787</p>	<p>EMS 309-3 1970-1995 90206 ----- EMS 309-6 1996-2000 95840</p>	<p>VS 309-3 1970-1985 Exc. 85 H5D Emissions 30055 ----- VS 309-5 1970-1985 Special Hi-Perf & 1985 H5D Emissions 5/16" C/R 50090 ----- VS 309-8 1986-1990 Silicone 50090 ----- VS 309-6 1991-2000 Silicone Bead 50388</p>	<p>TCS 309-3 1970-1995 Must use OP From 1991-1995 10 Bolt Cover 45060 ----- TCS 309-6 1996-2000 Must use OP 6 Bolt Cover 45969</p>	<p>RS 309-5 1970-1990 2 Pc. Split Seal 40096-1 ----- RS 309-8 1991-2000 Radial 40622</p>	<p>SS 309-5 1970-1990 71152 ----- SS 309-8 1991-2000 72823</p>



ENGINE INFORMATION	HEAD GASKET	HEAD KIT With <u>NO</u> Valve Stem Seals	HEAD SET With Valve Stem Seals	KIT SET	SHORT BLOCK SET
--------------------	-------------	--	--------------------------------------	---------	-----------------

GM Trucks, Mini-vans, & SUVs: V8

<p>7.5L 455 OHV V8 Oldsmobile Engine, 16 Vlv 1973-76</p> <p>VIN S 1976 VIN W 1973-1975</p>	<p>HG 603-3 1973-1976 8171-1</p>	<p>HK 603-3 Valley Pan Not Included 1973-1976 8171-4</p>	<p>HS 603-3 Valley Pan Not Included 1973-1976 8171-4</p>	<p>KS 603-3 Valley Pan Not Included 1973-1976 8171-4</p>	<p>ER 603-3 Valley Pan Not Included 1973-1976 8171-4</p>
<p>8.1L 496 OHV V8 Chevrolet Engine, 16 Vlv 2001-07</p> <p>VIN G 2001-2007 (VORTEC)</p>	<p>HG 330-1L 2001-2007 Left Side 26168 ----- HG 330-2R 2001-2007 Right Side 26169</p> <p>Head Bolt Set HB 330-5 2001-2007 (2 REQ'D.) 72188</p>	<p>HK 330-1 2001-2007 26167</p>	<p>HS 330-1 2001-2007 26168</p>	<p>KS 330-1 2001-2007 26168</p>	<p>ER 330-1 2001-2007 26168</p>



OIL PAN SET	INTAKE MANIFOLD SET	EXHAUST MANIFOLD SET	VALVE COVER SET	TIMING COVER SET	REAR SEAL SET	VALVE STEM SEAL SET
-------------	---------------------	----------------------	-----------------	------------------	---------------	---------------------

GM Trucks, Mini-vans, & SUVs: V8

<p>OP 603-3 1973-1976 13419</p>	<p>VP 603-5 1973-1976 96015</p>	<p>EMS 603-5 1973-1974 90078 ----- EMS 603-3 1975-1976 90021</p>	<p>VS 605-5 1973-1976 13403</p>	<p>TCS 605-3 1973-1976 13417</p>	<p>RS 109-5 1973-1976 Rope 13044-2 ----- RS 512-5 1973-1976 2 Pc. Rubber Optional 40032</p>	<p>SS 605-5 1973-1976 70393</p>
<p>OP 330-2 2001-2007 30714</p>	<p>MS 330-2 2001-2007 Upper & Lower Set 96057 ----- MS 330-4 2001-2007 Lower Set ----- MS 330-5 2001-2006 Upper Set ----- TB 330-2 2001 W/MFI 2002-2005 W/MFI Exc. Avalanche 61026</p>	<p>EMS 330-2 2001-2007 95840</p>	<p>VS 330-2 2001-2007 w/Grommets 50554</p>	<p>TCS 330-5 2001-2007 46007</p>	<p>RS 330-5 2001-2007 Radial PTFE 40673</p>	<p>SS 330-5 2001-2007 70579-1</p>



ENGINE INFORMATION	HEAD GASKET	HEAD KIT With <u>NO</u> Valve Stem Seals	HEAD SET With Valve Stem Seals	KIT SET	SHORT BLOCK SET
--------------------	-------------	--	--------------------------------------	---------	-----------------

International (Navistar) Trucks: 6 Cyl

3.8L 232 OHV L6 (High Torque) AMC Engine, 12 Vlv 1969-72	HG 082-5 1969-1972 8169	HK 082-5 1969-1972 8169-2	HS 082-5 1969-1972 8169-2	KS 082-5 1969-1972 8169-2	ER 082-5 1969-1972 8169-2
4.2L 258 OHV L6 AMC Engine, 12 Vlv 1972-74	HG 082-5 1972-1974 8169	HK 082-5 1972-1974 8169-2	HS 082-5 1972-1974 8169-2	KS 082-5 1972-1974 8169-2	ER 082-5 1972-1974 8169-2

International (Navistar) Trucks: V8

4.3L 266 OHV V8 International Engine, 16 Vlv 1959-72 BD264, BG264, BD265, SD264	HG 845-0 1959-1972 7905	HK 845-0 1959-1972 7905	HS 845-0 1959-1972 7905	KS 845-0 1959-1972 7905	ER 845-0 1959-1972 7905
5.0L 304 OHV V8 International Engine, 16 Vlv 1960-80 V304, V304E	HG 845-0 1960-1980 7905	HK 845-0 1960-1980 7905	HS 845-0 1960-1980 7905	KS 845-0 1960-1980 7905	ER 845-0 1960-1980 7905
5.6L 345 OHV V8 International Engine, 16 Vlv 1959-87 V345, V345E	HG 845-0 1959-1987 7905	HK 845-0 1959-1987 7905	HS 845-0 1959-1987 7905	KS 845-0 1959-1987 7905	ER 845-0 1959-1987 7905
5.6L 345 OHV V8 LPG International Engine, 16 Vlv 1967-80 V345, V345E	HG 845-0 1967-1980 7905	HK 845-0 1967-1980 7905	HS 845-0 1967-1980 7905	KS 845-0 1967-1980 7905	ER 845-0 1967-1980 7905
6.4L 392 OHV V8 w/o Improved Cooling International Engine, 16 Vlv 1956-87 To SN: 1013196	HG 850-0 1956-1987 7954	HK 850-0 1956-1987 7954-1	HS 850-0 1956-1987 7954-1	KS 850-0 1956-1987 7954-1	ER 850-0 1956-1987 7954-1
6.4L 392 OHV V8 w/ Improved Cooling International Engine, 16 Vlv 1956-87 From SN: 1013197	HG 855-0 1956-1987 8372	HK 855-0 1956-1987 8372	HS 855-0 1956-1987 8372	KS 855-0 1956-1987 8372	ER 855-0 1956-1987 8372
6.6L 404 OHV V8 International MV404 Engine, 16 Vlv 1975-87	HG 860-5 1975-1987 8475	HK 860-5 1975-1987 Valley Pan N/I 8475	HS 860-5 1975-1987 Valley Pan N/I 8475	KS 860-5 1975-1987 Valley Pan N/I 8475	ER 860-5 1975-1987 Valley Pan N/I 8475

OIL PAN SET	INTAKE MANIFOLD SET	EXHAUST MANIFOLD SET	VALVE COVER SET	TIMING COVER SET	REAR SEAL SET	VALVE STEM SEAL SET
-------------	---------------------	----------------------	-----------------	------------------	---------------	---------------------

International (Navistar) Trucks: 6 Cyl

OP 082-5 1969-1972 13881	MS 082-5 1969-1972 9982	USE MS	VS 082-5 1969-1972 50186	TCS 082-5 1969-1972 45117	RS 082-5 1969-1972 40612	SS 082-5 1969-1972 70530
OP 082-5 1972-1974 13881	MS 082-5 1972-1974 9982	USE MS	VS 082-5 1972-1974 40186	TCS 082-5 1972-1974 45117	RS 082-5 1972-1974 40612	SS 082-5 1972-1974 70530

International (Navistar) Trucks: V8

OP 855-0 1959-1972 12481	MS 845-0 1959-1972 9565	EMS 845-0 1959-1972 9566	VS 845-0 1959-1972 12484	TCS 855-0 1959-1972 12882-1	RS 855-0 1959-1972 5115	SS 303-3 1959-1972 O-Ring 5112
OP 855-0 1960-1980 12481	MS 845-0 1960-1980 9565	EMS 845-0 1960-1980 9566	VS 845-0 1960-1980 12484	TCS 855-0 1960-1980 12882-1	RS 855-0 1960-1980 5115	SS 303-3 1960-1980 O-Ring 5112
OP 855-0 1959-1987 12481	MS 850-0 1959-1987 9567	EMS 845-0 1959-1987 9566	VS 845-0 1959-1987 12484	TCS 855-0 1959-1987 12882-1	RS 855-0 1959-1987 5115	SS 303-3 1959-1987 O-Ring 5112
OP 855-0 1967-1980 12481	MS 850-2 1967-1980 9801	EMS 845-0 1967-1980 9566	VS 845-0 1967-1980 12484	TCS 855-0 1967-1980 12882-1	RS 855-0 1967-1980 5115	SS 303-3 1967-1980 O-Ring 5112
OP 855-0 1956-1987 12481	MS 850-0 1956-1987 9567	EMS 845-0 1956-1987 9566	VS 845-0 1956-1987 12484	TCS 855-0 1956-1987 12882-1	RS 855-0 1956-1987 5115	SS 303-3 1956-1987 O-Ring 5112
OP 855-0 1956-1987 12481	MS 855-0 1956-1987 90233	EMS 845-0 1956-1987 9566	VS 845-0 1956-1987 12484	TCS 855-0 1956-1987 12882-1	RS 855-0 1956-1987 5115	SS 303-3 1956-1987 O-Ring 5112
OP 533-8 1975-1987 34200	VP 860-5 1975-1987 96029	EMS 860-5 1975-1987 90316	VS 860-5 1975-1987 50158	TCS 860-5 1975-1987 45436	RS 860-5 1975-1987 40011	SS N/A



ENGINE INFORMATION	HEAD GASKET	HEAD KIT With <u>NO</u> Valve Stem Seals	HEAD SET With Valve Stem Seals	KIT SET	SHORT BLOCK SET
--------------------	-------------	--	--------------------------------------	---------	-----------------

International (Navistar) Trucks: V8

7.3L 444 OHV Diesel V8 (IDI) International Engine, 16 Vlv 1989-94 Includes 1992-1994 Turbo Eng. Turbo Parts Not In Kits	HG 533-8 1989-1994 9047	HK 533-8 1989-1994 9047	HS 533-8 1989-1994 9047	KS 533-8 1989-1994 9047	ER 533-8 1989-1994 9047
7.3L 444 E OHV V8 (DI) International Engine, 16 Vlv 1994-1997	HG 534-5 1994-1997 9239	HK 534-5 1994-1997 9239	HS 534-5 1994-1997 9239	KS 534-5 1994-1997 9239	ER 534-5 1994-1997 9239
7.3L 446 OHV V8 International MV Engine, 16 Vlv 1975-81	HG 860-5 1975-1981 8475	HK 860-5 1975-1981 8475	HS 860-5 1975-1981 8475	KS 860-5 1975-1981 8475	ER 860-5 1975-1981 8475
7.6L 461 OHV V8 International MV Engine, 16 Vlv 1960-64	HG 875-0 1960-1964 7786	HK 870-5 1960-1964 7786	HS 870-5 1960-1964 7786	KS 870-5 1960-1964 7786	ER 870-5 1960-1964 7786
7.8L 478 OHV V8 International V/V/S Engine, 16 Vlv 1965-76	HG 875-0 1965-1976 7786	HK 870-5 1965-1976 7786	HS 870-5 1965-1976 7786	KS 870-5 1965-1976 7786	ER 870-5 1965-1976 7786
9.0L 549 OHV V8 International V/V/S/FTV/FTVS Engine, 16 Vlv 1961-76	HG 875-0 1961-1976 7786	HK 870-5 1961-1976 7786	HS 870-5 1961-1976 7786	KS 870-5 1961-1976 7786	ER 870-5 1961-1976 7786

OIL PAN SET	INTAKE MANIFOLD SET	EXHAUST MANIFOLD SET	VALVE COVER SET	TIMING COVER SET	REAR SEAL SET	VALVE STEM SEAL SET
-------------	---------------------	----------------------	-----------------	------------------	---------------	---------------------

International (Navistar) Trucks: V8

OP 533-8 1989-1994 34200	VP 533-8 1989-1994 96038	EMS 533-8 1989-1994 91242	VS 533-8 1989-1994 50247	TCS 533-8 1989-1994 45575	RS 533-8 1989-1994 Radial 15868-1 -----	SS 533-8 1989-1994 72628-1
OP Use RTV	MS N/A	EMS 534-5 1994-1997 93489	VS 534-4 1994-1997 50483	TCS 534-5 1994-1995 45016 ----- TCS 534-6 1996-1997 45017	RS 534-5 1994-1997 Radial PTFE 40436	SS 534-5 1994-1997 72893
OP 533-8 1975-1981 34200	VP 860-5 1975-1981 96029	EMS 860-5 1975-1981 90316 ----- EMS 860-6 1975-81 HEAT SHIELD	VS 860-5 1975-1981 50185	TCS 860-5 1975-1981 45436	RS 860-5 1975-1981 Radial PTFE 40011	SS N/A
OP 870-5 1960-1964 34203	MS 870-5 1960-1964 9477	EMS 870-5 1960-1964 9479	VS 870-5 1960-1964 11784	TCS 870-5 1960-1964 11809-1	RS 870-5 1960-1964 Rope 12166	SS N/A
OP 870-5 1965-1976 34203	MS 870-5 1965-1976 9477	EMS 870-5 1965-1976 9479	VS 870-5 1965-1976 11784	TCS 870-5 1965-1976 11809-1	RS 870-5 1965-1976 Rope 12166	SS N/A
OP 870-5 1961-1976 34203	MS 870-5 1961-1976 9477	EMS 870-5 1961-1976 9479	VS 870-5 1961-1976 11784	TCS 870-5 1961-1976 11809-1	RS 870-5 1961-1976 Rope 12166	SS N/A



ENGINE INFORMATION	HEAD GASKET	HEAD KIT With <u>NO</u> Valve Stem Seals	HEAD SET With Valve Stem Seals	KIT SET	SHORT BLOCK SET
--------------------	-------------	--	--------------------------------------	---------	-----------------

Jeep: 4 Cyl

2.1L 126 2068cc SOHC Turbo Diesel L4 Renault 852 Engine 1985-90 VIN B 1985-1990 Eng. Code 852 *Piston Out of Deck less than .96mm(1.6mm) *Piston Out of Deck over 1.04mm(1.8mm) HG	HG 088-2 1985-1990 1.6 mm Thick 8065 ----- HG 088-4 1985-1990 1.8mm Thick 8077	N/A	HSX 088-2 1985-1990 HG N/I 8065	KSX 088-2 1985-1990 HG N/I 8065	N/A
2.2L 134 F-HEAD L4 HURRICANE Engine, 8 Vlv 1950-1973	HG 080-0 1950-1973 7543	N/A	HS 080-0 1950-1973 7543	KS 080-0 1950-1973 7543	N/A
2.2L 134 L-HEAD L4 LIGHTING Engine, 8 Vlv 1939-1968	HG 080-6 1939-1945 Exc. CJ 2A 7267 ----- HG 080-7 1940-1945 CJ 2A 1946-1968 7285	N/A	HS 080-6 1939-1945 Exc CJ 2A 7267 ----- HS 080-7 1940-1945 CJ 2A 1946-1968 7285	KS 080-6 1939-1945 Exc CJ 2A Military RM N/I 7267 ----- KS 080-7 1940-1945 CJ 2A 1946-1968 7285	N/A
2.4L 148 DOHC L4 Chrysler Engine, 16 Vlv 2002-04	HG 428-6 2002-2004 26206	HK 428-5 2002-2004 26206-1	HS 428-5 2002-2004 26206-1	KS 428-5 2002-2004 26206-1	N/A



OIL PAN SET	INTAKE MANIFOLD SET	EXHAUST MANIFOLD SET	VALVE COVER SET	TIMING COVER SET	REAR SEAL SET	VALVE STEM SEAL SET
-------------	---------------------	----------------------	-----------------	------------------	---------------	---------------------

Jeep: 4 Cyl

OP 088-2 1985-1990 30549	MS 088-2 1985-1990	USE MS	VS 088-2 1985-1990	TCS 088-2 1985-1990 Cam Frt Seal Set 45725	RS 088-5 1985-1990 Radial 40545	SS 081-5 1985-1990 72657
OP 080-0 1950-1973 4350	MS 080-0 1950-1973 9027	USE MS	VS 080-0 1950-1973 6617 ----- PS 080-0 1950-1973 Side Cover 4352	TCS 080-0 1950-1973 4351-1	RS 080-0 1950-1973 2 Pc. Rubber Exc. Military Eng. 3165	SS 080-0 1950-1973 O-Ring 407
OP 080-0 1939-1968 4350	MS 080-2 1939-1968 8348	USE MS	PS 080-0 1939-1968 Side Cover 4352	TCS 080-0 1939-1968 4351-1	RS 080-0 1939-1968 2 Pc. Rubber Exc. Military Eng. 3165	SS N/A
OP 428-5 2002-2004 30676	MS 428-8 2002-2004 93219	EMS 428-4 2002-2004 92846	VS 428-5 2002-2004 w/ Spark Plug Seals 50518	TCS 428-5 2002-2004 Cam Frt. Seal Set 2 Req'd 45961 ----- TCS 428-6 Crank Frt Seal Set 45962	RS 411-5 2002-2004 Radial 40182 ----- RS 408-8 2002-2004 Radial PTFE 40627	SS 414-5 2002-2004 72871



ENGINE INFORMATION	HEAD GASKET	HEAD KIT With <u>NO</u> Valve Stem Seals	HEAD SET With Valve Stem Seals	KIT SET	SHORT BLOCK SET
--------------------	-------------	--	--------------------------------------	---------	-----------------

Jeep: 4 Cyl

2.5L 150 OHV L4 AMC Engine, 8 Vlv 1983-2002	HG 083-0 1983-2002 9196	HK 083-0 1983-1990 9196 ----- HK 083-2 1991-1996 Exc 1991-1993 w/Aluminum VC 9196-1/-3 ----- HK 083-3 1991-1993 w/Aluminum VC 9196-4 ----- HK 083-4 1997-2002 9196-5	HS 083-0 1983-1985 9196 ----- HS 083-2 1986-1990 9196-1 ----- HS 083-3 1991-1993 w/Plastic VC 9196-2 ----- HS 083-4 1991-1993 w/Aluminum VC 9195-4 ----- HS 083-5 1994-1996 9196-3 ----- HS 083-6 1997-2002 9196-5	KS 083-0 1983-1985 9196 ----- KS 083-2 1986-1991 9196-1 ----- KS 083-3 1991-1993 w/Plastic VC OP For 1991 N/I 9196-2 ----- KS 083-4 1991-1993 w/Aluminum VC OP For 1991 N/I 9196-4 ----- KS 083-5 1994-1996 9196-3 ----- KS 083-7 1997-2002 9196-5	ER 083-0 1983-1990 9196 ----- ER 083-2 1986-1991 9196-1 ----- ER 083-3 1991-1993 w/Plastic VC OP For 1991 N/I 9196-2 ----- ER 083-4 1991-1993 w/Aluminum VC OP For 1991 N/I 9196-4 ----- ER 083-5 1994-1996 9196-3 ----- ER 083-7 1997-200 9196-5
2.5L 151 OHV L4 Pontiac Engine, 8 Vlv 1980-83	HG 312-5 1980-1983 9405-1	HK 312-5 1980-1983 8686-1	HS 312-5 1980-1983 8686-1	KS 312-5 1980-1983 8686-1	ER 312-5 1980-1983 8686-1

Jeep: 6 Cyl

2.8L 173 2835cc OHV V6 Chevrolet Engine, 12 Vlv 1984-86 VIN W 1984-1986 I.D. CODE T 1985-1986 I.D. CODE U 1985-1986 I.D. Code is located at front of block The code is the third character from the right	HG 305-5 1984-1986 8699-2	HK 305-5 1984-1986 Eng. Code T 8699-4 ----- HK 305-6 1985-1986 Eng. Code U 8699-6	HS 305-5 1984-1986 Eng. Code T 8699-4 ----- HS 305-6 1985-1986 Eng. Code U 8699-6	KS 305-5 1984-1986 Eng. Code T 8699-4 ----- KS 305-6 1985-1986 Eng. Code U 8699-6	ER 305-5 1984-1986 Eng. Code T 8699-4 ----- ER 305-6 1985-1986 Eng. Code U 8699-6
---	---------------------------------	---	---	---	---



OIL PAN SET	INTAKE MANIFOLD SET	EXHAUST MANIFOLD SET	VALVE COVER SET	TIMING COVER SET	REAR SEAL SET	VALVE STEM SEAL SET
-------------	---------------------	----------------------	-----------------	------------------	---------------	---------------------

Jeep: 4 Cyl

OP 083-0 1983-1991 30476 ----- OP 083-4 1992-2002 34007	MS 083-0 1983-2002 92100	USE MS	VS 083-0 1983-1990 50245 ----- VS 083-2 1991-1993 w/Plastic VC 1994-1996 50430 ----- VS 083-3 1991-1993 w/Aluminum VC 50421 ----- VS 083-5 1997-2002 50502	TCS 083-0 1983-2002 Use w/OP 1992-2002 45117	RS 312-5 1983-2002 Radial 40578	SS 083-0 1983 70622 ----- SS 083-2 1984-1985 72668 ----- SS 083-5 1986-1993 70816 ----- SS 083-6 1994-2002 72854
OP 312-5 1980-1983 30409	MS 312-5 1980-1983 90563	EMS 312-5 1980-1983 90564	VS 312-5 1980-1983 50179	TCS 302-3 1980 13198 ----- TCS 312-6 1982-1983 13198-2	RS 312-5 1980-1983 Radial 40578	SS 312-5 1981 O-Ring 5112 ----- SS 312-6 1981-1986 72531

Jeep: 6 Cyl

OP 305-5 1984 30411 ----- OP 305-6 1985-1986 30512 ----- OP 305-8 1984-1986 Goodwrench Replacement 34501	MS 305-6 1984-1986 91022	EMS 305-5 1984-1986 90864	VS 305-5 1984 & 1985-1986 Eng. Code T 50182 ----- VS 305-6 1985-1986 Eng. Code U 50272	TCS 305-5 1984-1986 45466	RS 315-3 1984 2 Pc. Rubber 40422 ----- RS 315-5 1984 Radial 40465 ----- RS 315-6 1985-1986 11mm Radial 40464	SS 305-5 1984-1986 72530
--	--------------------------------	---------------------------------	---	---------------------------------	---	--------------------------------



ENGINE INFORMATION	HEAD GASKET	HEAD KIT With <u>NO</u> Valve Stem Seals	HEAD SET With Valve Stem Seals	KIT SET	SHORT BLOCK SET
--------------------	-------------	--	--------------------------------------	---------	-----------------

Jeep: 6 Cyl

3.8L 232 OHV L6 (High Torque) AMC Engine 12 Vlv 1965-79 VIN E 1967-1979	HG 082-5 1965-1979 8169	HK 082-5 1965-1979 8169-2	HS 082-5 1965-1979 8169-2	KS 082-5 1965-1979 8169-4	ER 082-5 1965-1979 8169-4
4.0L 242 OHV L6 AMC Engine, 12 Vlv 1987-2006 VIN L 1989-1990 VIN M 1987-1988 VIN S 1991-2006 VIN V 1997-2005	HG 082-8 1987-2003 9076-1 ----- HG 082-10 2004-2006 26211	HK 082-8 1987-1990 9076 ----- HK 082-9 1991-1993 9076-1 ----- HK 082-10 1994-1995 9076-2 ----- HK 9082-11 1996-1998 9076-3 ----- HK 082-12 1999-2003 9076-4 ----- HK 082-14 2004-2006 26211	HS 082-8 1987-1990 9076 ----- HS 082-9 1991-1993 9076-1 ----- HS 082-10 1994-1995 9076-2 ----- HS 9082-11 1996-1998 9076-3 ----- HS 082-12 1999-2003 9076-4 ----- HS 082-14 2004-2006 26211	KS 082-8 1987-1990 9076 ----- KS 082-9 1991-1993 9076-1 ----- KS 082-10 1994-1995 9076-2 ----- KS 9082-11 1996-1998 9076-3 ----- KS 082-12 1999-2003 9076-4 ----- KS 082-14 2004-2006 26211	ER 082-8 1987-1990 9076 ----- ER 082-9 1991-1993 9076-1 ----- ER 082-10 1994-1995 9076-2 ----- ER 9082-11 1996-1998 9076-3 ----- ER 082-12 1999-2003 9076-4 ----- ER 082-14 2004-2006 26211
4.2L 258 OHV L6 AMC Engine, 12 Vlv 1971-90 VIN A 1971-1979 VIN C 1977-1988 VIN M 1988-1989 VIN T 1989-1990	HG 082-5 1971-1990 Exc. 1981-1985 8169 ----- HG 082-6 1981-1985 8778	HK 082-5 1971-1980 8169-2 ----- HK 082-6 1986-1990 Plastic VC 8169-3 ----- HK 082-7 1986-1990 Aluminum VC 8169 ----- HK 082-8 1981-1985 VS N/I 8778	HS 082-5 1971-1980 8169-2 ----- HS 082-6 1986-1990 Plastic VC 8169-3 ----- HS 082-7 1986-1990 Aluminum VC 8169 ----- HS 082-8 1981-1985 VS N/I 8778	KS 082-5 1971-1980 8169-2 ----- KS 082-6 1986-1990 Plastic VC 8169-3 ----- KS 082-7 1986-1990 Aluminum VC 8169 ----- KS 082-8 1981-1985 VS N/I 8778	ER 082-5 1971-1980 8169-2 ----- ER 082-6 1986-1990 Plastic VC 8169-3 ----- ER 082-7 1986-1990 Aluminum VC 8169 ----- ER 082-8 1981-1985 VS N/I 8778



OIL PAN SET	INTAKE MANIFOLD SET	EXHAUST MANIFOLD SET	VALVE COVER SET	TIMING COVER SET	REAR SEAL SET	VALVE STEM SEAL SET
-------------	---------------------	----------------------	-----------------	------------------	---------------	---------------------

Jeep: 6 Cyl

<p>OP 082-5 1965-1979 13881-1 ----- OP 082-6 1971-1979 Optional 1 Pc. Silicone 34308</p>	<p>MS 082-5 1965-1979 9982</p>	<p>USE MS</p>	<p>VS 082-5 1965-1979 50186</p>	<p>TCS 082-5 1965-1979 45117</p>	<p>RS 082-5 1965-1979 40612</p>	<p>SS 082-5 1965-1979 70530</p>
<p>OP 082-5 1987-1991 13881-1 ----- OP 082-6 1987-1991 Optional 1992-2006 1 Pc. Silicone 34308</p>	<p>MS 082-8 1987-1990 93680 ----- MS 082-9 1991-1998 94790 ----- MS 082-10 1999-2006 93094</p>	<p>USE MS</p>	<p>VS 082-8 1995-1997 50022-1 ----- VS 082-10 1996-2006 w/ Grommets 50458</p>	<p>TCS 082-5 1987-1991 1992-2006 Use w/ Oil Pan 45117</p>	<p>RS 082-5 1987-2000 2 Pc. Rubber 40612 ----- RS 082-6 2001-2006 2 Pc. Rubber 40183</p>	<p>SS 082-6 1987-1993 70819 ----- SS 082-8 1994-2006 72835</p>
<p>OP 082-5 1971-1990 13881-1 ----- OP 082-6 1971-1990 1 Pc Silicone 34308</p>	<p>MS 082-5 1971-1980 9982 ----- MS 082-6 1981-1990 90949</p>	<p>USE MS</p>	<p>VS 082-5 1971-1980 50186 ----- VS 082-6 1981-1990 50244 ----- VS 082-8 1986-1990 w/Aluminum VC 50022-1</p>	<p>TCS 082-5 1971-1990 45117</p>	<p>RS 082-5 1971-1990 40612</p>	<p>SS 082-5 1971-1990 70530</p>



ENGINE INFORMATION	HEAD GASKET	HEAD KIT With <u>NO</u> Valve Stem Seals	HEAD SET With Valve Stem Seals	KIT SET	SHORT BLOCK SET
--------------------	-------------	--	--------------------------------------	---------	-----------------

Jeep: V8

4.7L 287 SOHC V8 Chrysler Engine, 16 Vlv 1999-2006 VIN J 2002-2004 VIN N 1999-2006	HG 415-5 1999-2006 26157 Head Bolt Set HB 415-5 1999-2006 71129	HK 415-5 1999-2003 26157 ----- HK 415-6 2004-2006 26157-1	HS 415-5 1999-2003 26157 ----- HS 415-6 2004-2006 26157-1	KS 415-5 1999-2003 26157 ----- KS 415-6 2004-2006 26157-1	ER 415-5 1999-2003 26157 ----- ER 415-6 2004-2006 26157-1
5.0L 304 OHV V8 AMC Engine, 16 Vlv 1971-81	HG 084-5 1971-1981 8211-1	HK 084-5 1971-1981 Valley Pan N/I 8211-4	HS 084-5 1971-1981 Valley Pan N/I 8211-4	KS 084-5 1971-1981 Valley Pan N/I 8211-4	ER 084-5 1971-1981 Valley Pan N/I 8211-4
5.2L 318 OHV V8 Chrysler Engine, 16 Vlv 1993-98 vin y 1993-1998	HG 405-8 1993-1998 26179	HK 405-10 1993-1997 26179-1 ----- HK 405-13 1998 26179-2	HS 405-10 1993-1997 26179-1 ----- HS 405-13 1998 26179-2	KS 405-10 1993-1997 26179-1 ----- KS 405-13 1998 26179-2	ER 405-10 1993-1997 26179-1 ----- ER 405-13 1998 26179-2
5.7L 350 OHV V8 Buick Engine, 16 Vlv 1968-71 VIN K 1971 VIN 9 1969-71	HG 106-5 1968-1971 8364-1	HK 106-5 1968-1971 Valley Pan N/I 8364-1	HS 106-5 1968-1971 Valley Pan N/I 8364-1	KS 106-5 1968-1971 Valley Pan N/I 8364-1	ER 106-5 1968-1971 Valley Pan N/I 8364-1
5.9L 360 OHV V8 Chrysler Engine, 16 Vlv 1998 VIN Z 1998	HG 405-6 1998 9898	HK 405-6 1998 9898-2	HS 405-6 1998 9898-2	KS 405-10 1998 9898-2	ER 405-10 1998 9898-2

OIL PAN SET	INTAKE MANIFOLD SET	EXHAUST MANIFOLD SET	VALVE COVER SET	TIMING COVER SET	REAR SEAL SET	VALVE STEM SEAL SET
-------------	---------------------	----------------------	-----------------	------------------	---------------	---------------------

Jeep: V8

OP 415-5 1999-2006 30709	MS 415-5 1999-2006 93205	EMS 415-5 1999-2006 93217	VS 415-5 1999-2003 50521 ----- VS 415-6 2004-2006 50577	TCS 415-5 1999 To 5/13/02 46000 ----- TCS 415-8 From 5/13/02-2006 46022	RS 415-5 1999-2006 Radial 40186	SS 415-5 1999-2006 71041
OP 085-5 1971-1981 30187	VP 085-5 1971-1981 96011	EMS 085-5 1971-1981 90166	VS 085-5 1971-1981 50001	TCS 085-5 1971-1981 45003	RS 085-5 1971-1981 2 Pc. Rubber 40003	SS 084-5 1971-1972 12443 ----- SS 085-5 1973-1981 70529
OP 405-4 1993-1998 34408	MS 405-10 1993-1997 Upper & Lower 95392 ----- MS 405-11 1998 Upper & Lower 95392-1 ----- MS 405-14 1993-1998 Upper Set 95462	EMS 405-6 1993-1998 95480	VS 405-6 1993-1998 50419	TCS 405-5 1993-1996 45952 ----- TCS 405-6 1997-1998 45996	RS 405-9 1993-1998 2 Pc. Rubber 40181	SS 405-10 1993-1998 72844
OP 106-5 1968-1971 13397-1	VP 106-5 1968-1971 96006	EMS 106-5 1968-1971 90241	VS 106-5 1968-1971 50034	TCS 106-5 1968-1971 Rope Seal 45006 ----- TCS 109-6 1968-1971 Radial Rubber Seal 45930	RS 109-5 1968-1971 Rope 13044-2	SS 106-5 1968-1971 70092-1X2
OP 405-5 1998 34409	MS 405-10 1998 Upper & Lower 95392-1 ----- MS 405-14 1998 Upper Set 95462	EMS 405-6 1998 95480	VS 405-6 1998 50419	TCS 405-6 1998 45996	RS 405-10 1998 2 Pc. Rubber 40651	SS 405-10 1998 72844



ENGINE INFORMATION	HEAD GASKET	HEAD KIT With <u>NO</u> Valve Stem Seals	HEAD SET With Valve Stem Seals	KIT SET	SHORT BLOCK SET
--------------------	-------------	--	--------------------------------------	---------	-----------------

Jeep: V8

5.9L 360 OHV V8 AMC Engine, 16 Vlv 1970-93 VIN N 1970-88 VIN P 1973-1978 VIN 7 1989-1993	HG 085-5 1970-1993 8266-1	HK 085-5 1970-1993 Valley Pan N/I 8266-4	HS 085-5 1970-1993 Valley Pan N/I 8266-4	KS 085-5 1970-1993 Valley Pan N/I 8266-4	ER 085-5 1970-1993 Valley Pan N/I 8266-4
6.6L 401 OHV V8 AMC Engine, 16 Vlv 1974-78 VIN Z 1974-1978	HG 085-5 1974-1978 8266-1	HK 085-5 1974-1978 Valley Pan N/I 8266-4	HS 085-5 1974-1978 Valley Pan N/I 8266-4	KS 085-5 1974-1978 Valley Pan N/I 8266-4	ER 085-5 1974-1978 Valley Pan N/I 8266-4



OIL PAN SET	INTAKE MANIFOLD SET	EXHAUST MANIFOLD SET	VALVE COVER SET	TIMING COVER SET	REAR SEAL SET	VALVE STEM SEAL SET
-------------	---------------------	----------------------	-----------------	------------------	---------------	---------------------

Jeep: V8

OP 085-5 1970-1993 30187	VP 085-5 1970-1993 96011	EMS 085-5 1970-1993 90166	VS 085-5 1970-1993 50001	TCS 085-0 1970-1993 45003	RS 085-5 1970-1993 40003	SS 085-5 1970-1993 70529
OP 085-5 1974-1978 30187	VP 085-5 1974-1978 96011	EMS 085-5 1974-1978 90166	VS 085-5 1974-1978 50001	TCS 085-0 1974-1978 45003	RS 085-5 1974-1978 40003	SS 085-5 1974-1978 70529



About Copper Head Gaskets

SCE Copper Head Gaskets are the superior choice for blown, nitrous, turbocharged and high compression engines. SCE Copper Head Gaskets can be used for deck/piston height adjustments. For example; if an assembled piston and rod combination is too high for the deck, (piston too close to the head) a thicker head gasket can be used to restore proper clearance. Conversely, if increased compression ratio is desired, a thinner gasket can be used. However, reason must be used when adjusting compression ratio with gasket thickness as every .010" change in thickness, nets approximately 2.5cc in volume. This method will never raise an 8.5 to 1 street engine to a 12.5 to 1 race engine or vice versa.

SCE strongly recommends the use of o-rings to seal combustion pressure, most notably when there are only 4 head bolts per cylinder. O-ring grooves can be cut into the block or cylinder head. The proper dimensions for .041" stainless wire (supplied in SCE kit – see page 68) are: .040" groove width; .030" to .032" groove depth.* When cutting/installing stainless o-ring wire, file the ends square, to provide a tight "joint" for the best seal possible.

SCE Titan and ICS Titan self sealing copper head gaskets require no sealant, however if you are using Pro Copper head gaskets, we recommend an anaerobic sealer such as Hylomar or Copper Coat. Always allow the sealant to tack up for 15 to 20 minutes before assembly.

Head gaskets on racing engines should be re-torqued after initial run-in, regardless of type, solid copper or composition. SCE recommends using factory torque specs and sequences. Allow the engine to cool for accurate readings. Always use a torque wrench and have it calibrated often.

Clean, flat surfaces are essential to seal a racing engine. Premium grade head bolts with hardened washers are recommended and studs are preferred.

* O-ring height should be no more than 25% of gasket thickness.

Compression Ratio Formula

Compression Ratio (CR) is defined as the quantitative relation between the total volume above the piston at BDC, and the clearance volume above the piston at TDC. To determine compression ratio you need to know:

- 1. Cylinder volume (V)** or cylinder displacement, determined by cylinder bore and stroke (indicated by movement of piston from BDC to TDC).

Cylinder volume formula (in cubic inches):
 $Bore \times Bore \times Stroke \times .7854$

- 2. Clearance Volume (V_{CL})** is the volume above the piston (actually above the top piston ring) at TDC. It consists of several small volumes which are measured in cubic centimeters, or CCs, as follows:

Deck Clearance Volume formula:
 $Bore \times Bore \times Depth \text{ of Piston @ TDC} \times 12.87$

Gasket Volume formula:
 $Bore \text{ of Gasket} \times Bore \text{ of Gasket} \times Thickness \times 12.87$
 (or refer to the chart below)

Valve Notch Volume: Available from your piston MFG, or must be CC'd using a burette. This figure must be **added** to clearance volume.

Piston Dome Volume: Available from your piston MFG, or must be CC'd using a burette. This figure must be **subtracted** from clearance volume.

Combustion Chamber Volume: Available from your cylinder head MFG, or must be CC'd using a burette.

- 3. Convert Total Clearance Volume** from CCs to cubic inches, **multiply** by .06102.
- 4. Add the two volumes together** (V + V_{CL}), then **divide** by V_{CL}.
 The formula is: $CR = V + V_{CL} / V_{CL}$

GASKET VOLUME CHART (IN CCs) GASKET THICKNESS

GASKET BORE	.021	.032	.043	.050	.062	.072	.080	.093
3.000	2.432	3.706	4.980	5.791	7.181	8.339	9.266	10.772
3.080	2.563	3.906	5.249	6.104	7.569	8.790	9.767	11.354
3.150	2.681	4.086	5.491	6.385	7.917	9.194	10.216	11.876
3.250	2.854	4.350	5.845	6.796	8.428	9.787	10.875	12.642
3.260	2.872	4.376	5.881	6.838	8.480	9.847	10.942	12.720
3.305	2.952	4.498	6.044	7.028	8.715	10.121	11.246	13.073
3.375	3.078	4.691	6.303	7.329	9.089	10.555	11.727	13.633
3.437	3.192	4.865	6.537	7.601	9.426	10.946	12.162	14.139
3.500	3.310	5.045	6.779	7.882	9.774	11.351	12.612	14.662
3.625	3.551	5.411	7.272	8.455	10.485	12.176	13.529	15.728
3.670	3.640	5.547	7.453	8.667	10.747	12.480	13.867	16.121
3.750	3.800	5.791	7.782	9.049	11.221	13.030	14.478	16.831
3.850	4.006	6.104	8.202	9.538	11.827	13.735	15.261	17.741
3.950	4.216	6.465	8.635	10.040	12.450	14.458	16.064	18.674
4.010	4.345	6.622	8.898	10.347	12.830	14.900	16.556	19.246
4.060	4.455	6.788	9.122	10.607	13.152	15.274	16.971	19.729
4.155	4.665	7.110	9.554	11.109	13.775	15.997	17.775	20.663
4.200	4.767	7.264	9.762	11.351	14.075	16.345	18.162	21.113
4.250	4.881	7.438	9.995	11.623	14.412	16.737	18.597	21.619
4.320	5.043	7.685	10.327	12.009	14.891	17.293	19.214	22.337
4.380	5.184	7.900	10.616	12.345	15.308	17.777	19.752	22.962
4.440	5.327	8.118	10.909	12.685	15.730	18.267	20.297	23.595
4.520	5.521	8.414	11.306	13.146	16.302	18.931	21.035	24.453
4.570	5.644	8.601	11.557	13.439	16.664	19.352	21.503	24.997
4.620	5.768	8.790	11.812	13.735	17.031	19.776	21.976	25.547

IN-BLOCK O-RING WIRE INSTALLATION INSTRUCTIONS

Step 1. When installing o-rings there are two main considerations for placement.
 A. The o-ring must be clear of the sealant beads on the gasket where applicable. This will determine the maximum outer diameter of the o-ring.
 B. The o-ring diameter and location must accommodate bore opening and combustion chamber size and shape. This will determine the minimum inside diameter of the o-ring.

Step 2. Recommended o-ring protrusion is not more than 25% gasket thickness
 Example: Gasket thickness .043", o-ring protrusion height is .008" to .010". This standard works with all thicknesses that are .050" and less. Gaskets that are thicker than .050" do not require -ring height more than .012".

Step 3. If the combustion chamber or bore is so large that the o-rings will be placed less than .100" apart between cylinders, it is advisable to use a "figure 8" pattern for o-rings. This allows for more even clamping load over the entire head surface.

Step 4. New head studs/bolts are recommended for proper gasket sealing. Threads must be in good condition otherwise replace, a die can be used to remove old sealant and/or rust. Use a tap to clean threads in block. If threads are tapped through the deck, use care in sealing threads to prevent coolant migration up the bolt. If studs are to be used check for proper length so nuts do not "bottom out". Always use quality hardened washers and thread lubricant to prevent galling.

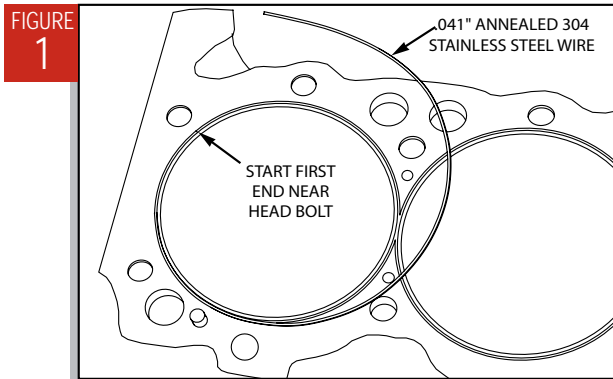

Trial fit and cut wire to approximate length +1.00". Using pliers and a fine mill file, square the starting end and insert near a head bolt.

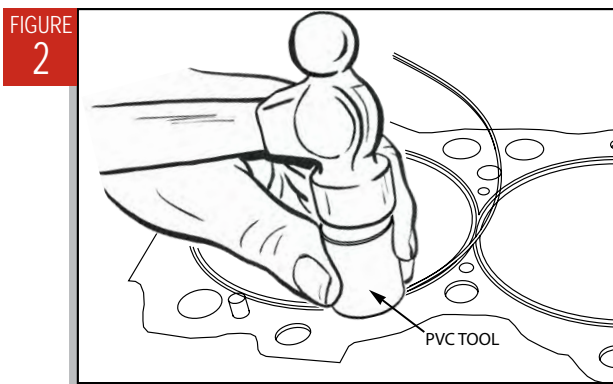

Seat the wire using the PVC tool provided in kit #31542. This will evenly distribute hammer blows and prevent flattening the wire.

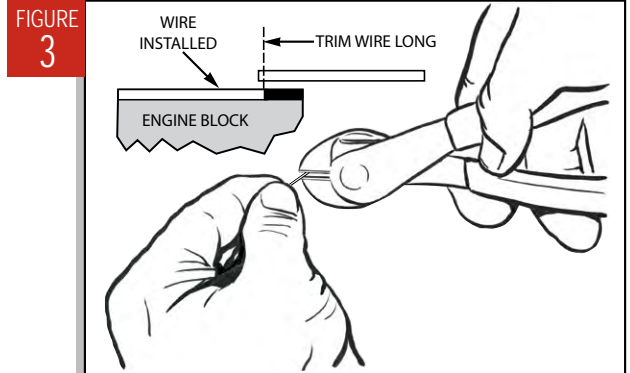

After working your way around the bore, stop a few inches short and trim the wire slightly long in preparation for final fit.

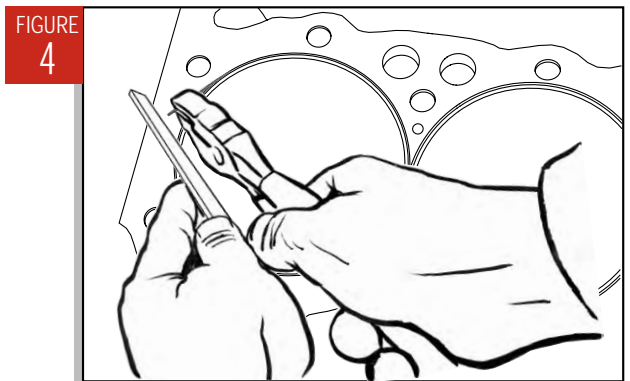

Next using pliers and fine mill file, carefully fit the wire making a tight joint. If the gap is too wide start over. There is enough wire in the kit #31542 for approximately 10 cylinders.

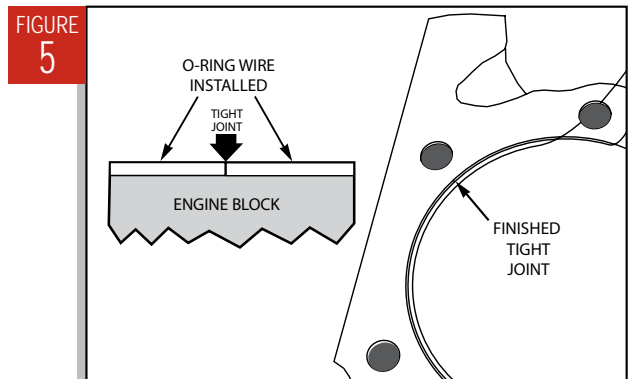

After a few tries you can get the joint so tight that it is almost invisible. You can then take pride in having done by hand one of the most important steps in sealing your high performance engine.

Titan™ Copper Head Gaskets

SAMPLE Part # T11064

Recommended uses: Racing Engines with Heavy Boost or Nitrous running liquid coolant.

NOTE: O-rings are required in the block or head, Sealant is not required.

STEP 1 - Before installing head gasket, visually inspect for shipment damage. Sealant beads must be continuous without gaps or scratches.

STEP 2 - Titan series head gaskets require o-ring combustion seals installed in the head or block. (p/n 31542 o-ring kit) Great care has been taken to allow as much room as possible for o-ring placement, if your o-rings are already in the head or block check to see that the sealant beads are clear of the o-ring. (Continue to step 3 below)

Pro Copper™ Head Gaskets

SAMPLE Part # P11064

Recommended uses: Extreme Racing Engines such as Blown Alcohol or Nitromethane.

NOTE: This gasket requires o-rings (receiver grooves may also be needed with extreme extreme boost or nitrous) and sealant for coolant or oil passages.

STEP 1 - Before installing the gasket perform a visual check to insure that no damage occurred during shipping. The gaskets should be flat and free of dents or scratches.

STEP 2 - All SCE copper head gaskets are annealed in a vacuum oven after the punching process to provide malleable gaskets which are ready to use, do not use a torch to soften the gaskets. (Continue to step 3 below)

The Following Instructions Are Common to Both Titan Copper Head Gaskets and Pro Copper Head Gaskets.

STEP 3 - When installing o-rings there are two main considerations for placement.

A. The o-ring must be clear of the sealant beads on the gasket. This will determine the maximum outer diameter of the o-ring.

B. The o-ring diameter and location must accommodate bore opening and combustion chamber size and shape, this will determine the minimum inside diameter of the o-ring.

STEP 4 - Recommended o-ring protrusion is not more than 25% of gasket thickness (SEE FIGURE 1 BELOW). Example: Gasket thickness .043", o-ring protrusion height is .008" to .010". This standard works with all thicknesses that are .050" and less. Gaskets that are thicker than .050" do not require o-ring height more than .012".

STEP 5 - If the combustion chamber or bore is so large that the o-rings will be placed less than .100" apart between cylinders, it is advisable to use a "figure 8" pattern for o-rings (SEE FIGURE 2 BELOW). This allows for more even clamp load over the entire head surface.

STEP 6 - New head studs/bolts are recommended for proper gasket sealing. Threads must be in good condition otherwise replace, a die can be used to remove old sealant and/or rust. Use a tap to clean threads in block. If threads are tapped through the deck, use care in sealing threads to prevent coolant migration up the bolt. If studs are to be used check for proper length so nuts do not "bottom out". Always use quality hardened washers and thread lubricant to prevent thread galling.

STEP 7 - As with any performance application it is strongly recommended that head bolts/studs be re-torqued. Start the engine and allow it to reach operating temperature without placing any load on the motor. Shut down and allow the motor to cool to ambient temperature. With the engine cold and following the recommended torque sequence, one at a time back each fastener off just enough to relieve the friction set, then re-torque to specified torque value.

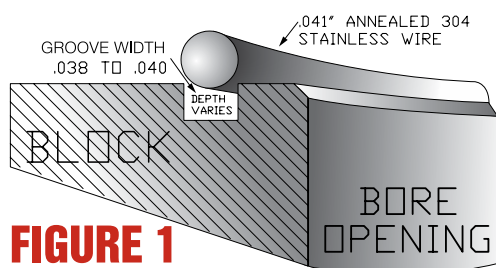

FIGURE 1

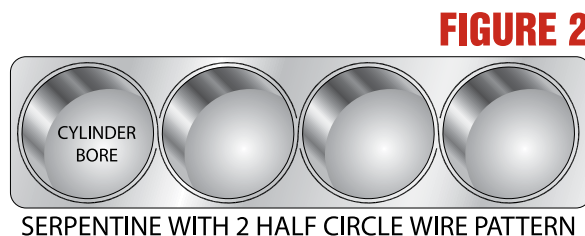

FIGURE 2

ICS Titan™ Self-Sealing Head Gaskets

Sample Part # S11064

Recommended uses: High Performance Street, Mild to Heavy Race, with Medium to High Boost or Nitrous.

Note: Do not use o-rings, sealant (such as Copper Coat or Hylomar) may be used if desired.

STEP 1 Before installing head gasket, visually inspect for shipment damage. Sealant beads must be continuous without gaps or scratches and the wire should not protrude out from combustion seal.

STEP 2 Gasket to head check, place cylinder head on a bench flat side up. Align new gasket on head in the assembled location, check to insure 360° metal to metal contact on combustion seal paying close attention to valve reliefs, see illustrations below.

STEP 3 Using extreme care, block and head mating surfaces should be scraped clean of any gasket material. Remove oil, grease, or sealant with proper cleaning solvent.

STEP 4 Check head and block mating surfaces to insure flatness within .002" using a steel straight edge and thickness gauge. If a sealing surface exceeds .002" out of flat, have the component resurfaced to an 80ra finish or better.

STEP 5 New head studs/bolts are recommended for proper gasket sealing. Threads must be in good condition otherwise replace, a die can be used to remove old sealant and/or rust. Use a tap to clean threads in block. If threads are tapped through the deck, use care in sealing threads to prevent coolant migration up the bolt. If studs are to be used check for proper length so nuts do not "bottom out". Always use quality hardened washers and thread lubricant to prevent thread galling.

STEP 6 If sealant is desired for street engines, apply a light coat of spray Copper Coat or Hylomar on both sides, then let the gasket set for at least an hour before installing. Position new gasket over locating dowels on block. Position cylinder head over dowel pins without disturbing gasket, Tighten bolts and torque in sequence per manufacturers' specifications.

STEP 7 These gaskets must be re-torqued. Start the engine and allow it to reach operating temperature without placing any load on the motor. Shut down and allow the motor to cool to ambient temperature. With the engine cold and following the recommended torque sequence, one at a time back each fastener off just enough to relieve the friction set, then re-torque to specified torque value.

INSURE 360° CONTACT

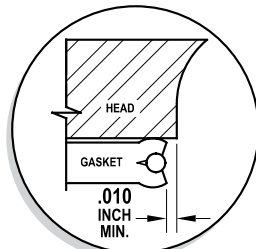
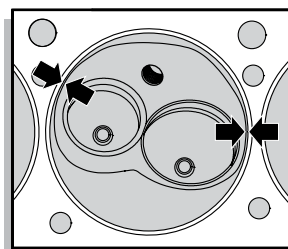

CORRECT

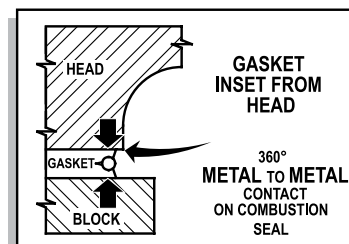

INCORRECT

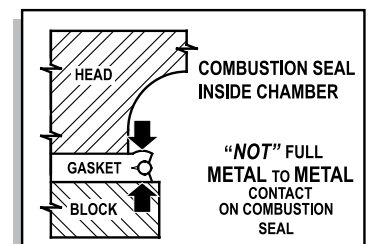

SCE Pro Copper™ Embossed Exhaust Gaskets



SCE Embossed Pro Copper Exhaust Gaskets outperform other gaskets because the sealing beads conform to header or manifold sealing surfaces. However, mismatched gaskets (such as a D-port gasket on an oval header) will cause leaks because the embossment is not in complete contact with the raised weld bead of the header. Pro Copper exhaust gaskets will provide years of leak free performance by following these simple steps are followed.

STEP 1 Determine the shape & size of the header or manifold opening. **Note:** with this type of gasket, the shape of the cylinder head exhaust port opening is of secondary concern. See illustration below.

STEP 2 Select the SCE Pro Copper exhaust gasket which most closely matches the shape and size of the header or manifold opening. Insure that the embossed sealing bead will rest on the raised weld bead of the header sealing surface when assembled.

STEP 3 Clean and lubricate the threads in the cylinder head so full clamping is achieved when bolts are torqued. Once the gasket is fully seated the bolts will not loosen because the gasket is solid metal and will not shrink from repeated heat cycling.*

STEP 4 Install gaskets and torque to specification. Proper torque for new lubricated 3/8" x 16 grade 5 bolts is between 25 and 30 foot pounds.

* Extreme heat applications such as towing may cause the gaskets to relax slightly as indicated by a "ticking" sound at idle. Do not discard the gasket; simply re-torque the bolts, 1 re-torque is usually sufficient for permanent sealing.

Embossed Copper Gasket Selection

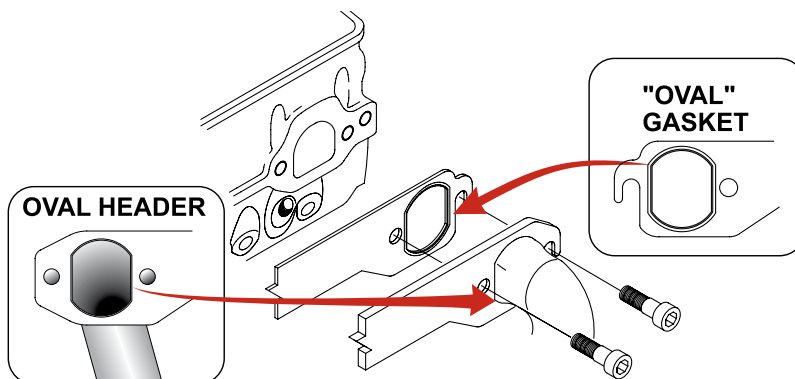

Note: be sure to match gasket shape to header shape!

SCE Pro Seal Composite Head Gasket



Sample Part # 511144

Recommended uses: Stock Replacement to Mild Race with Mild Boost or Nitrous

Note: Do not use with sealants or o-rings

STEP 1 Before installing the gasket perform a visual check to insure that no damage occurred during shipping. The gasket(s) should be flat and free of dents or scratches.

STEP 2 Good engine building practice requires clean, flat surfaces and clean head bolt / stud threads. Use a solvent degreaser to remove oil from block & head. If fastener threads are tapped through the deck, use care in sealing the threads with a quality sealant (part # G1615) to prevent coolant migration up the threads.

STEP 3 Quality fasteners are critical to the success of your project. OEM style head bolts are fine as long as they are new. When using studs make sure there is adequate thread length so that nuts don't "bottom out". Always use thread lubricant and good quality hardened washers. It is always recommended to follow engine manufacturer torque sequence and values.

STEP 4 As with any performance application it is strongly recommended that head bolts/studs be re-torqued. Start the engine and allow it to reach operating temperature without placing any load on the motor. Shut down and allow the motor to cool to ambient temperature. With the engine cold and following the recommended torque sequence, one at a time back each fastener off just enough to relieve the friction set, then re-torque to specified torque value.



SCE One-Piece Oil Pan Gaskets

To insure that your engine oil pan gasket is sealed properly and for prolonged care free performance, please follow these instructions.

Step 1 - Scrape and clean engine block and oil pan mating surfaces. Remove any oil or grease with proper cleaner.

Step 2 - Check oil pan holes and flanges for flatness. Check bolts for stripped threads or heads, threads must be straight and clean, replace as necessary.

Step 3 - To allow for differences in aftermarket oil pan stampings, use "small" dab of RTV sealant ONLY at rail ends front and back of oil pan as shown.

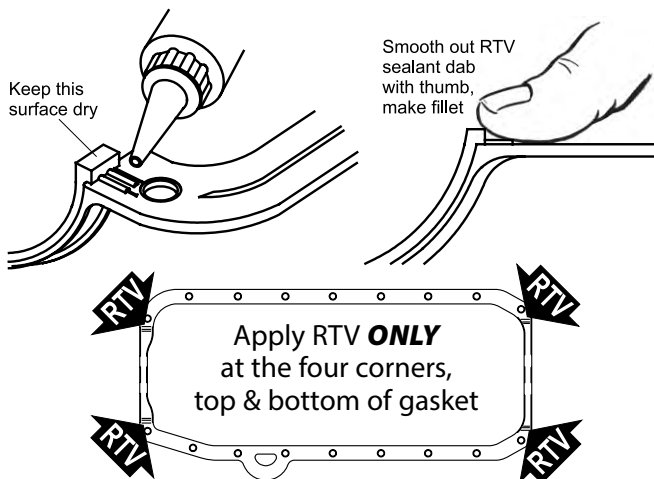

Step 4 - Install SCE "One-Piece" oil pan gasket to engine block paying close attention to tab inserts at rear main cap and front cover assembly, then set oil pan in place carefully. Install oil pan bolts and torque to manufacturer's requirements in sequence, "crush limiters" will prevent damage to gasket from over tightening.

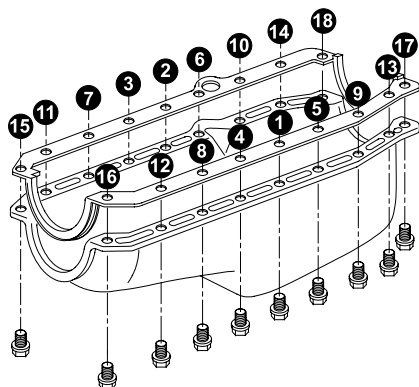

Step 5 - Torque oil pan bolts. Basic torque specifications for Chrysler, Ford, and GM engines.

Chrysler -
Torque to 100 inch-lbs.

Ford -
Torque to 100 inch-lbs.

GM -
Torque to 100 inch-lbs.
(For Chevy small block V6 and V8 engines 1986 and later).

Follow tightening sequence as shown in Step 4.

Step 6 - Add engine oil and check for leaks, then start engine and re-check for oil leaks.

Under Car Installation

For under car installation of SCE "One-Piece" oil pan gaskets it is helpful to use a light adhesive such as "Gasgacinch" to hold the gasket in place during assembly. For ease of assembly please follow these tips:

1. Lay the gasket block side up and apply a light coat of adhesive on both pan rails, let tack for 5 minutes. Apply RTV sealant as shown in Step-3.
2. Thoroughly clean all oil and grease from engine mating surfaces and apply a light coat of adhesive to engine block rails, let tack for 5 minutes.
3. Locate the pan gasket on the engine using 1 bolt in center of each pan rail, then stick gasket in place paying close attention to tab inserts at rear main cap and front cover as required.
4. Remove locating bolts and install oil pan and bolts, torque as required.

Note: It is critical that tab inserts at rear main cap are properly seated. Do not install gasket on oil pan first and attempt to assemble to block as it is difficult to align and insert tabs properly. If tabs are not seated properly serious leakage may occur.



SCE Project Car

- 1968 Camaro
- Engine: 383ci
- 476 HP @ 5700 rpm
- 476 ft. lbs. @ 4700 rpm
- Carb: Barry Grant 750 cfm
- Cylinder Heads: Brodix Track 1
- Pistons: Ross 10.5:1
- Crankshaft: Scat
- Camshaft: Comp Cams Hyd. roller
- Ignition: MSD digital 6
- Trans: Richmond 6 speed
- Gear Ratio: 3.08:1
- 4 Whl Disc Brakes by SSBC

Growing to Meet Demand

This issue of the SCE Gaskets catalog represents completion of a sizeable transition for the company. Acquisition of the Iowa gasket manufacturing plant in late 2011 began an 18 month period of system, facility and equipment upgrades, production streamlining, launch of the Engine Master Gaskets kit product line and a completely new look for the company.

Performance Under Pressure

As always, SCE Gaskets continues to develop new sealing products for the performance and racing community as seen in the Racing & Performance section of this book. Lessons learned in racing 'spill over' into our new Engine Master Gasket line for street vehicles resulting in high quality USA made gaskets for any popular domestic car or light truck engine made in the last 60 years.

Continuing Innovation

SCE Gaskets works with top professionals developing and testing new sealing ideas under the most extreme conditions to bring you dependable gaskets that 'Seal it Tight'. Embossed Copper Exhaust gaskets, patented ICS Titan Head Gaskets, Dyno Pak bulk packs, Precision- Molded Carb Gaskets and proprietary steel-core materials are just some of the ways we've made engine sealing easier.

With sincere thanks,

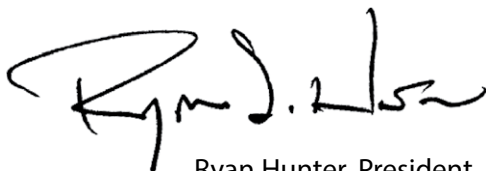

Ryan Hunter, President



24927 Avenue Tibbitts
Valencia, California 91355
661-728-9200



618 10th Avenue East
Spencer, Iowa 51301
712-262-9313