

GOODSON

Tools and Supplies for Engine Builders

2019

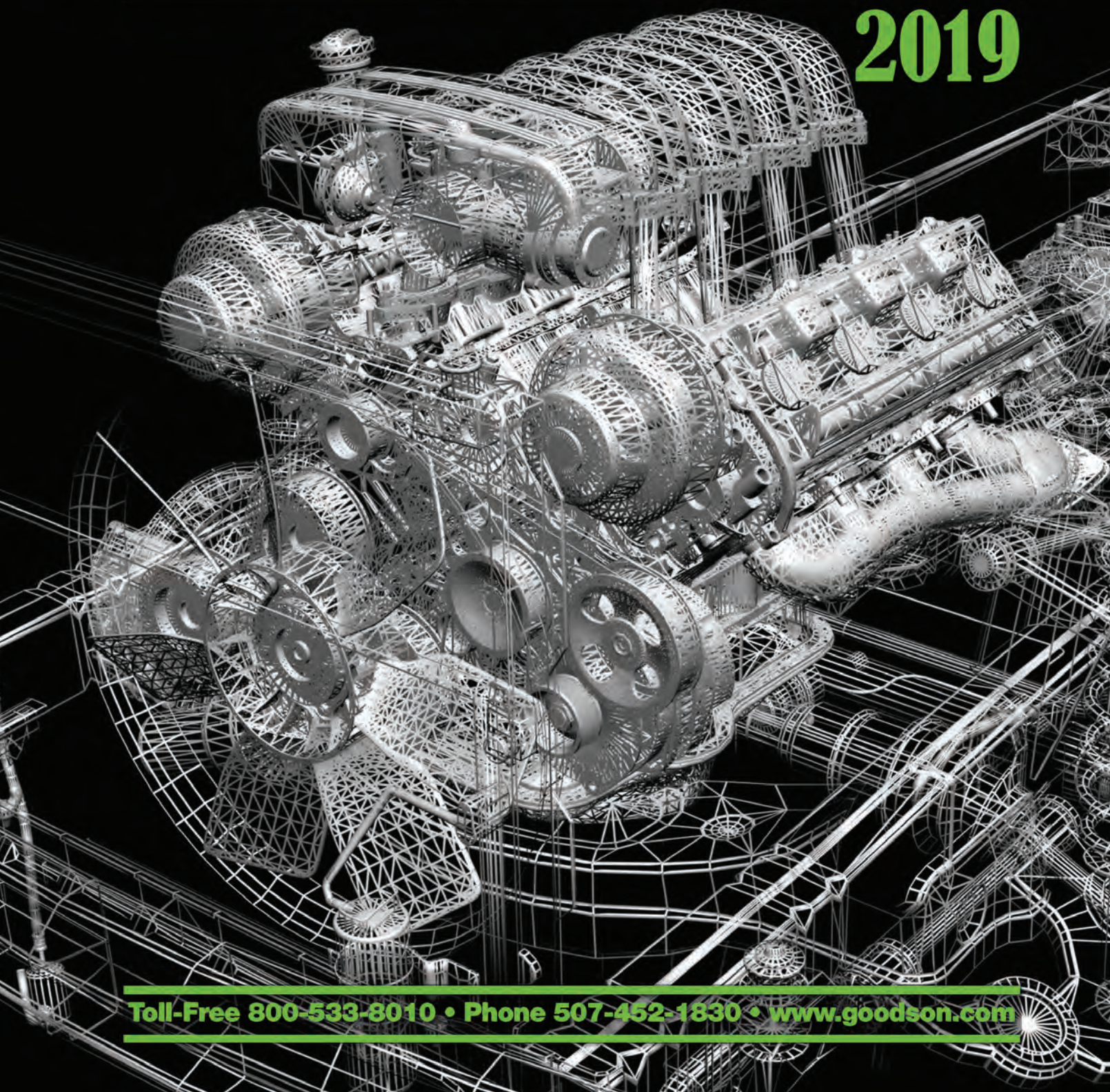

Toll-Free 800-533-8010 • Phone 507-452-1830 • www.goodson.com

From the President's Desk

Anticipation. That's how we approach each and every day here at Goodson and we hope you do too.

What can you anticipate when you contact Goodson?

You can anticipate receiving the best customer service you've ever experienced. You can anticipate quality made, well designed products that will make your job easier, all at a competitive price. You can anticipate highly trained Technical Advisors who will answer your questions and help you choose the right products.

In short, you can anticipate Full Service ... Fast!



Roger Schumacher,
Goodson President



California Prop65 Warning



WARNING: Cancer and Reproductive Harm -
www.P65Warnings.ca.gov

"Proposition 65 requires businesses to provide warnings to Californians about significant exposures to chemicals that cause cancer, birth defects or other reproductive harm."

Due to recent regulatory changes in California, we must now warn you that many of the products commonly used to manufacture our products contain chemicals known to the state of California to cause cancer and reproductive harm.

A complete list of materials requiring the Prop 65 warning can be found at <https://www.p65warnings.ca.gov>.

WARNING: Operating, servicing and maintaining a passenger vehicle or off-road vehicle can expose you to chemicals including engine exhaust, carbon monoxide, phthalates, and lead, which are known to the State of California to cause cancer and birth defects or other reproductive harm. To minimize exposure, avoid breathing exhaust, do not idle the engine except as necessary, service your vehicle in a well-ventilated area and wear gloves or wash your hands frequently when servicing your vehicle. For more information go to

www.P65Warnings.ca.gov/products/passenger-vehicle

GOODSON Ironclad Guarantee



Goodson won't risk losing your business for any reason. If you're not 100% satisfied with your purchase, we'll fix it, exchange it or credit your account for the purchase price. To send an item back, just include a note detailing the reason for the return and ship it back, freight pre-paid within 60 days. The only time we can't honor this guarantee is if a tool has been damaged through misuse or modification. All abrasives have a shelf life so we can only guarantee them for one year from the original purchase date.



Erik Shepard



Chris Jensen

Goodson Techxperts™ on staff to help you

When you have questions about product applications, tooling interchangeability, machining procedures, extending tool life, engine specs or any other technical topic, give the Goodson Tech Services Department a call at 1-800-533-8010.

Contact Us

Customer service representatives and our Techxperts™ are available from 8:00am to 5:00pm, Monday through Friday (Central time).

Phone: 1-800-533-8010 (US & Canada)
1-507-452-1830 (International)

Fax: 1-888-466-3909 (US & Canada)
1-507-452-2907 (International)

Please note that the Goodson offices will be closed in observance of the following 2019 holidays: New Year's Day (January 1), Memorial Day (May 27), Independence Day (July 4), Labor Day (September 2), Thanksgiving (November 28 & 29) and Christmas (December 24 & 25).

We're always open on the web!

Web: www.goodson.com

Email: orderdesk@goodson.com

Goodson Sister Companies Mach-B Grinding Wheel Shaping & Resizing



From routine grinding wheel shaping and sizing to emergency work, **Mach-B Can Do That!**

Mach-B Grinding Wheel Shaping & Resizing specializes in:

- Custom Grinding Wheel Shaping
- Custom Grinding Wheel Sizing
- Reducing Outside Diameters
- Increasing Inside Diameters
- ANSI Compliant Speed Testing
- Static Balance Testing
- Standard and Custom Profiles
- Grinding Wheel Slotting
- Grinding Wheel Radius Dressing

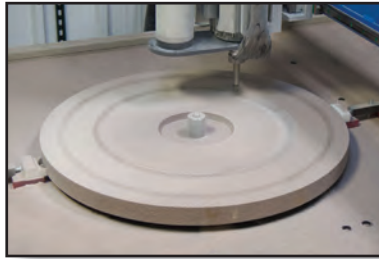

Turn to Mach-B and Goodson for Fast Turnaround — three working days or less. Visit www.mach-b.com for more information.

Abrasive Industrial Supplies Specializing in Coated Abrasive Belts, Discs and More

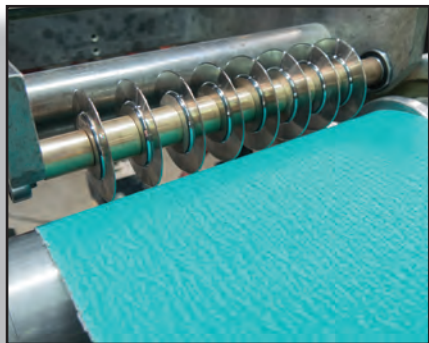

Another addition to the Goodson stable of companies, **Abrasive Industrial Supplies (AIS)** was added in the 4th Quarter of 2017. **AIS** is an abrasive belt converter. Not only does **AIS** manufacture most of the abrasive belts you'll

see in this year's catalog, but if you're looking for something custom in terms of width or length or material or grit, odds are they can make it happen.

Visit the **AIS** website at: www.abrasiveindustrialsupplies.com today.



Visit the Goodson Website All Day, Every Day

When was the last time you visited the Goodson website? Hopefully, you check it out on a regular basis. If not, let us encourage you to take a look at it today. That's right, put the catalog down; fire up your computer and punch www.goodson.com into your web browser.

What will you find when you visit the site?

- Convenience – you can order any time, day or night
- A complete listing of the products in the catalog and then some
- Information – Tech tips and videos
- Expanded technical information on some products that just won't fit in the printed catalog
- A complete library of product instructions, including those for products no longer available
- Current Safety Data Sheets
- Much more

Visit www.goodson.com today!



A TYROLIT Company

RAPIDEX

A rapid-use index of product categories

Cylinder Head Rebuilding

Pilots.....	1-3
Valve Seat Work.....	4-22
Valve Refacing.....	23-25
Reamers.....	26-27
Valve Guide Resizing.....	28-30
Valve Guide Replacement.....	31-35
Valve Seal Work.....	36
Valve Spring Work.....	37-43
Cylinder Head Resurfacing.....	44-47
Crack Detection & Repair.....	48-53
Porting & Polishing.....	57-59

Cleaning, Assembly & Safety

Parts Storage & Organizers.....	60, 66
Wire Wheels & Brushes.....	62-63
Cleaning.....	62-69
Parts Baskets.....	66
Last Blast Paint & Metal Markers.....	70
Assembly Lubes.....	71
Flex-Hones®.....	72

Index Falls between pages 72 and 73

Coolants & Lubricants.....	73
----------------------------	----

Short Block Rebuilding

Cylinder Boring & Honing.....	74-81
Boring Bar Tooling & Supplies.....	74-75
Honing Stones.....	76-81
Rod Honing.....	82-83
Rod & Piston Work.....	84-89
Lifter Bore Tooling.....	91
Camshaft Work.....	92-93

Crankshaft/Flywheel Grinding

Crankshaft Grinding Wheels.....	94-95
Crankshaft Grinding & Polishing.....	96-100
Flywheel Grinding.....	102-104

Miscellaneous Tools

Diamond Dresser Tools.....	106-107
Machine Replacement Parts.....	108-109

Brake Service Tooling

Brake Tips & Holders.....	110-111
Brake Lathe Silencers.....	112
Brake Lathe Replacement Parts.....	113-115
Brake Lathe Mounting Adaptors.....	116

Measuring Tools

Dial Bore Gauges.....	118-119
Micrometers.....	120
Calipers & Dial Indicators.....	121

V-Twin & Metric Hard Parts

Seats & Seat Inserts.....	122, 123
Valve Guides.....	122, 124
Replacement Valves.....	122, 125
Valve Springs.....	122, 126-127

© Copyright 2019, Goodson Mfg. Co., Inc. All copy and illustrations are copyrighted. Absolutely no mechanical or electronic reproduction or use of any part is allowed without our prior written permission. Goodson reserves the right to correct printing errors. Prices are subject to change without notice.

Policies

See the last page of the Index for more information about these policies.

Pricing:

Prices are subject to change without notice. There is no minimum order. Orders are billed at the prices in effect at the time of shipping. Discounts are not available on Sunnen® products.

Shipping:

Goodson typically ships orders the same day they are received. Orders received after hours, on weekends or holidays are shipped the next business day. If your order is lost in shipping, Goodson works with the shipper to provide tracking service. Please inspect all shipments upon receipt and report damage or errors within 48 hours.

Freight:

For orders shipped ground within the USA, you may deduct the freight charges on any **JOBBER** net invoice of \$800 or more if you pay within 30 days of the invoice date. Glass Beads, Steel Shot, Tumbler Media, Machines, Equipment, Bulk Liquids and Crankwheels are not included. Hazardous Materials, Dangerous Goods & Dimensional Shipping fees may apply on some items.

Terms:

- 1) A 1% discount is given on merchandise if payment is made within 15 days from **invoice** date. This discount applies only to the merchandise amount (not the total amount) on the **invoice** (not a statement). The discount amount is shown in the lower left hand corner of the invoice. This discount does not apply to statement payments and does not apply to credit card orders.
- 2) Invoices not paid in full within 30 days from the statement date are subject to a finance charge of 1.5% per month (18% per year).

Credit & Debit Card Orders:

Goodson accepts MasterCard, Visa, American Express and Discover Card. For your security, credit card numbers are **NOT** kept on file. Credit card orders do not qualify for the 1% quick-pay discount.

Check Acceptance:

In the unlikely event that your check is returned for insufficient or held funds, we will debit your checking account electronically for the face amount of the check plus the service fee allowed by your state's law. This allows us to resolve the problem without turning you over to a collection agency and harming your credit rating. The transaction will appear on your bank statement and no one will have to contact you about payment.

Returns:

You may return any item, except special orders, within 60 days. We will do our best to correct any problems or to send a replacement. If an item was damaged through mis-use or modification, Goodson will not accept it as a return. Credits will only be issued after it is determined that the part is resellable or it is deemed defective.

ABRASIVES WARRANTY: Abrasives have a shelf life, therefore, all abrasives are warranted against manufacturing defects for 1 year from the date of original purchase.

RESETTING/RESHARPENING SERVICE: Premium Diamonds can be reset and many of our cutting tools can be resharpened. Send your resets and sharps to GOODSON Tools & Supplies, ATTN: Resharps, 156 Galewski Dr. Winona, MN 55987. Be sure to include your customer number.

CYLINDER HEAD REBUILDING
CLEANING, ASSEMBLY & SAFETY
SHORT BLOCK REBUILDING
CRANKSHAFT/ FLYWHEEL GRINDING
MISCELLANEOUS TOOLS & SUPPLIES
BRAKE SERVICE TOOLING
MEASURING TOOLS
V-TWIN & METRIC HARD PARTS

Goodson exclusive

Not just for
Oil Galleries Anymore
Now fits Lifter Bores,
Cam Bores Main Bores
& Cylinder Bores!



Watch the YouTube
Video to see the HPOG
in action!



Scan the code to go directly to the
Video or Visit YouTube and search
for "Goodson HPOG-1000"

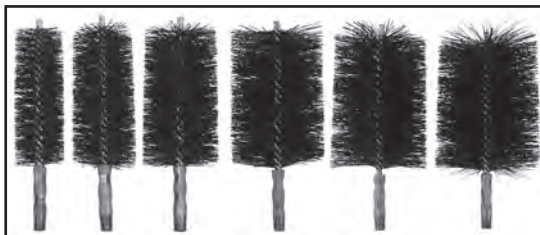

Ergonomically designed
grip made
of billet aluminum



Water Pressure
Button

Air Pressure Button
125PSI Max

Stainless Steel wand will not corrode

Threaded to make
brush changes quick and easy

Air/Water outlet
holes are drilled in an
spiral pattern to create a
swirling motion to enhance the
wand's cleaning power.

3 Stainless Steel
Brushes come standard with this
kit — 3/8", 1/2" and 3/8" diameter



High Pressure Oil Gallery (& More) Cleaning System

Aggressively clean oil galleries,
lifter bores, cam bearing bores, main
bores and cylinder bores — Gas to
Diesel, Stock to High-Performance

- Ergonomically designed handle
- Incorporates the aggressive cleaning action of a stainless steel or nylon brush with the hydro action of a specially designed water manifold to be used in conjunction with your shop air to quickly and easily clean the oil gallery holes in gas and diesel engines
- Standard Kit includes a 36"L cleaning wand with pistol grip air/water manifold and 3 brushes (3/8", 1/2" & 5/8" dia.) • 110°F max water temp.

Description	Jobber	Order No.	Incl.
Standard Kit	\$329.99	HPOG-1000	▼
36" Cleaning Wand	59.99	HPOG-W36	x
18" Cleaning Wand (optional)	49.99	HPOG-W18	
3/8" Stainless Steel Cleaning Brush	9.99	HPOG-375	x
1/2" Stainless Steel Cleaning Brush	9.99	HPOG-500	x
5/8" Stainless Steel Cleaning Brush	9.99	HPOG-625	x
3/8" Nylon Cleaning Brush w/ 8-32 thread	7.99	HPOG-375N	
1/2" Nylon Cleaning Brush w/ 8-32 thread	7.99	HPOG-500N	
5/8" Nylon Cleaning Brush w/ 8-32 thread	7.99	HPOG-625N	
3/4" Nylon Cleaning Brush w/ 8-32 thread	7.99	HPOG-750N	
13/16" Nylon Cleaning Brush w/ 8-32 thread	7.99	HPOG-812N	
7/8" Nylon Cleaning Brush w/ 8-32 thread	7.99	HPOG-875N	
1" Nylon Cleaning Brush w/ 8-32 thread	7.99	HPOG-1000N	
1 1/4" Nylon Cleaning Brush w/ 8-32 thread	7.99	HPOG-1125N	
8-32 Thread Adaptor	29.99	HPOG-832ADP	
2" Nylon Cleaning Brush w/ 1/4" pipe thread	29.99	HPOG-2000N	
2 1/4" Nylon Cleaning Brush w/ 1/4" pipe thread	29.99	HPOG-2250N	
2 1/2" Nylon Cleaning Brush w/ 1/4" pipe thread	29.99	HPOG-2500N	
3" Nylon Cleaning Brush w/ 1/4" pipe thread	29.99	HPOG-3000N	
3 1/2" Nylon Cleaning Brush w/ 1/4" pipe thread	29.99	HPOG-3500N	
4" Nylon Cleaning Brush w/ 1/4" pipe thread	29.99	HPOG-4000N	
4 1/2" Nylon Cleaning Brush w/ 1/4" pipe thread	29.99	HPOG-4500N	
5" Nylon Cleaning Brush w/ 1/4" pipe thread	29.99	HPOG-5000N	
1/4" Pipe Thread Adaptor	39.99	HPOG-14ADP	
1/4" Spray Nozzle	69.99	HPOG-125NOZ	

CYLINDER HEAD REBUILDING
CLEANING, ASSEMBLY & SAFETY
SHORT BLOCK REBUILDING
FLYWHEEL GRINDING
CRANKSHAFT/
MISCELLANEOUS TOOLS & SUPPLIES
BRAKE SERVICE TOOLING
MEASURING TOOLS
V-TWIN & METRIC HARD PARTS

Back By Popular Demand!

CYLINDER HEAD
REBUILDING

CLEANING,
ASSEMBLY & SAFETY

SHORT BLOCK
REBUILDING

CRANKSHAFT/
FLYWHEEL GRINDING

MISCELLANEOUS
TOOLS & SUPPLIES

BRAKE SERVICE
TOOLING

MEASURING
TOOLS

V-TWIN & METRIC
HARD PARTS



Prevent Premature Oil Pump Wear With The Goodson Distributor Depth Gauge

Working on a Big Block or Small Block Chevy with a distributor? Avoid problem wear and potential failure caused by a distributor that fits too deep. This easy to use gauge measures the depth of engagement allowing you to compensate to create adequate clearance. Kit comes complete with a .500" diameter adaptor. An optional .491" shaft is also available.

Description	Jobber	Order No.
Distributor Depth Gauge Kit	\$229.99	DDG-05
.491" Shaft	64.99	DDG-491

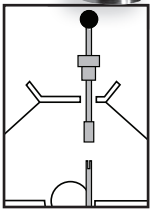

Fig. 1 Insert depth gauge in place of distributor. Bottom out in oil pump drive.

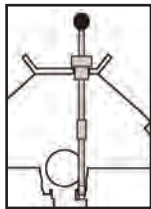

Fig. 2 Push down on the top collar, making contact with manifold.

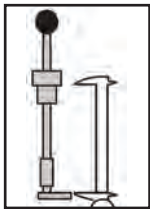

Fig. 3 Remove depth gauge from engine. Install adaptor in distributor tool. Measure and record depth.

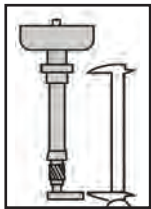
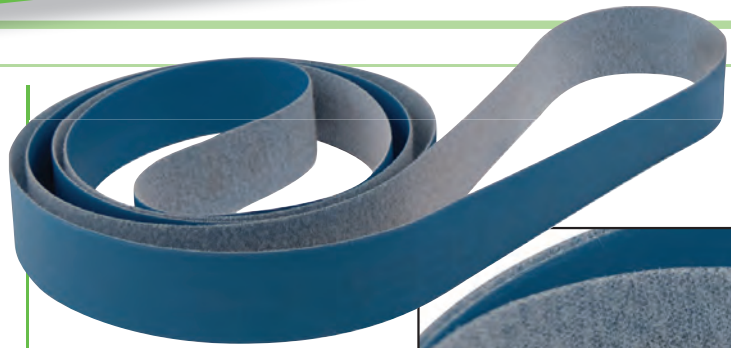

Fig. 4 Install adaptor in distributor drive. Measure as before and compare. Shim as needed to create clearance.



800 Grit Crankshaft Polishing Belts With Scrum Back

- Film substrate with aluminum-oxide abrasive
- 10 belts per box
- Mylar joint with scrum back
- Highly flexible and long lasting

Length	Width	Jobber	Order No.
60"	3/4"	\$29.99	BF-60X3/4X800
	1"	31.99	BF-60X1X800
64"	3/4"	29.99	BF-64X3/4X800
	1"	47.99	BF-64X1X800
72"	3/4"	44.99	BF-72X3/4X800
	1"	53.99	BF-72X1X800
77"	1"	53.99	BF-77X1X800

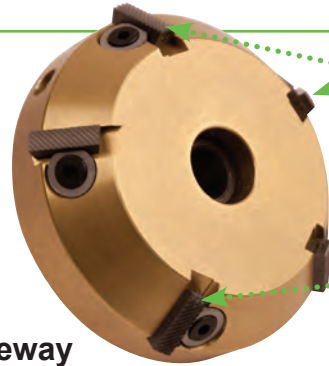

Adjustable Tungsten Carbide cutter blades. Cutters work in a range from 3/8" smaller and 1/4" larger than the cutter body size. Replaceable cutter blades (see chart for which blades to order for your cutter) are included with body purchase.

Neway High Performance Valve Seat Cutters

- Special angles let you touch up seats at the track
- Adjustable Tungsten-Carbide cutter blades work in a range from 3/8" smaller to 1/4" larger than the cutter body size
- Cutter body is anodized aluminum on a steel hub
- More Neway cutters on page 12

Description	Jobber	Order No.
Standard Series Cutter Bodies (Use .375" Top Pilots - page 1)		
Cutter Body Diameter	Blade Angle	Qty. Replacement Blade
2.000" / 50.8mm	42°	7 NCB-251
	50°	5 NCB-251
2.250" / 57.0mm	55°	5 NCB-251
	47°	7 NCB-251
2.500" / 63.5mm	50°	7 NCB-251
	52°	7 NCB-251
	55°	7 NCB-251
	65°	7 NCB-252
		289.99 NCU-25065*

*Special Angles for Noonan Heads - Use 42° for Exhaust, 47° for Intake, 65° for Throat Exhaust/Intake



Sun-Dura® Canvas Machine Cover for Sunnen® AG-Series Precision Gauge

- Heavy-weight, breathable Sun-Dura® black fabric protects your valuable Precision Gauge without holding in moisture
- Dimensions: 8"L x 8"W x 4"D
- Order No. GMC-AG-300 Jobber \$36.99

Use VG-STOP for extra long stemmed valves

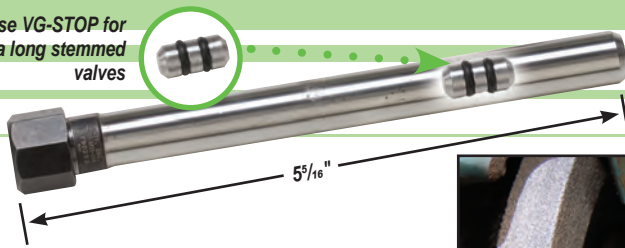

Adaptor for 1/2" Chucks

- For small diameter valves
- Hardened steel collet holder fits any machine with 1/2" chuck
- Collet seats in retainer nut for fast, easy removal • Internal stop adjusts with a screwdriver, allowing you to reface an entire set of valves to identical specs quickly
- Collets cover range of 2.8 - 6.5mm
- Start with the set then replace collets as needed (**collets will not work without the holder**) • Use the Adaptor Stop to work on longer valves • Kit includes 4 collets to fit 4.0 to 6.5mm range



Description	Range	Jobber	Order No.	Incl.
Starter Set (6 Pieces)		\$299.99	UVRC-46	▼
Steel Collet Holder (collets MUST be used)		205.99	UVRC-46R	x
Replacement Collets	2.8 to 3.2mm (.109" to .125")	38.99	UVRC-18	
	3.0 to 3.5mm (.118" to .138")	38.99	UVRC-3.5MM	
	3.5 to 4.0mm (.138" to .158")	38.99	UVRC-4.0MM	x
	4.0 to 4.5mm (.158" to .177")	38.99	UVRC-4.5MM	
	4.4 to 4.8mm (.172" to .188")	38.99	UVRC-316	
	4.5 to 5.0mm (.177" to .196")	38.99	UVRC-5MM	x
	4.8 to 5.2mm (.188" to .203")	38.99	UVRC-1364	
	5.0 to 5.5mm (.196" to .216")	38.99	UVRC-5.5MM	x
	5.5 to 6.0mm (.217" to .236")	38.99	UVRC-6.0MM	x
	6.0 to 6.5mm (.236" to .256")	38.99	UVRC-6.5MM	x
Adaptor Stop		13.99	VG-STOP	x



Out of Print - Limited Edition!



Mondello Oldsmobile V-8 Engine Technical Reference Manual #4

- GM Manual #12480027
- Revised in 2010
- Written by Joe Mondello (Dr. Olds)
- While supplies last
- Order No. **MA-OLDS**
- Jobber \$19.99

Enlarged for detail

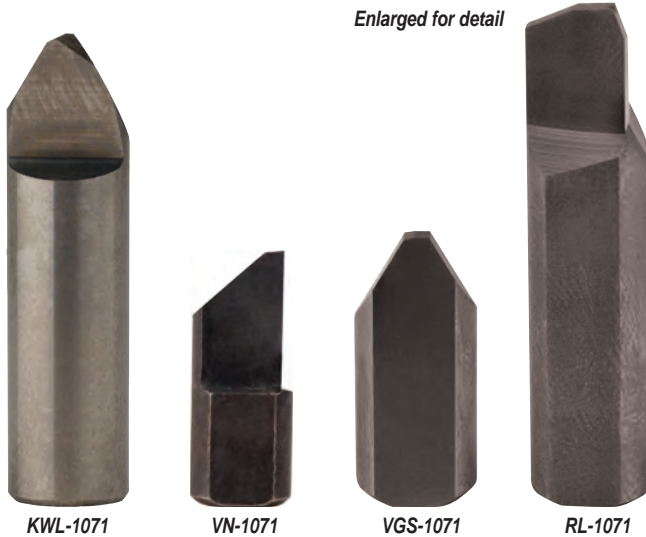

Solid Carbide Single Pass Boring Tools

- Greater fracture resistance than most carbide bits
- Ideal for hard alloys or interrupted cuts in automotive, high performance, marine, motorcycle and diesel engines

Description	Jobber	Order No.
Kwik-Way 5/16" x 1 13/64" L	\$ 69.99	KWL-1071
Van Norman 1/4" x 5/8" L	69.99	VN-1071
Van Norman 3/8" x 7/8" L	69.99	VGS-1071
Rottler 1 1/32" x 1 7/16" L	69.99	RL-1071

Spring Compressor Comes Standard With Large Receiver

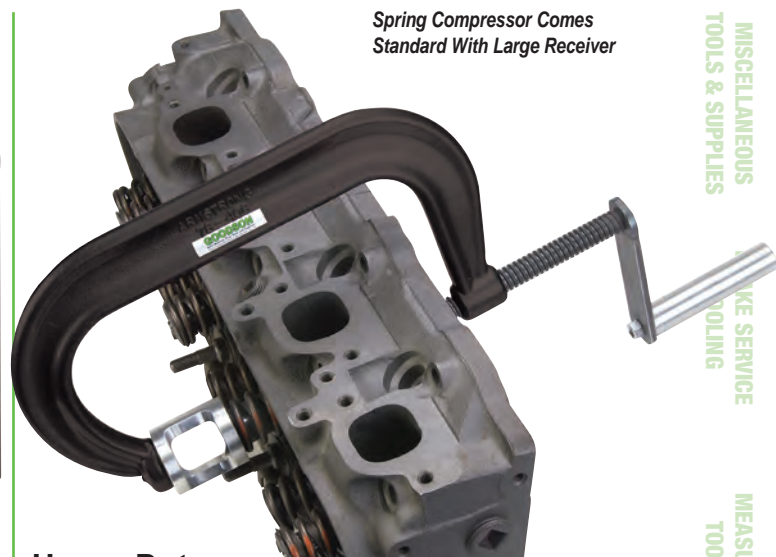

Heavy Duty Manual Valve Spring Compressor

- Drop forged steel frame
- Open receiver design allows for quick access to keepers
- Accommodates springs up to 1 3/4" diameter
- 8 1/2" throat • 6" deep
- Compresses springs up to 1000 pounds

Description	Jobber	Order No.
Manual Valve Spring Compressor	\$279.99	CF-1300
Small Receiver (OD: 1.625", ID: 1", Height: 2.156")	99.99	CF-1300SF
Large Receiver (OD: 2.0", ID: 1.197", Height: 2.25")	99.99	CF-1300LF

CYLINDER HEAD REBUILDING
 ASSEMBLY & SAFETY
 CLEANING
 SHORT BLOCK REBUILDING
 FLYWHEEL GRINDING
 CRANKSHAFT/
 MISCELLANEOUS TOOLS & SUPPLIES
 LIKE SERVICE
 MEASURING TOOLS
 V-TWIN & METRIC HARD PARTS



"In addition to the wide selection of tools and supplies found in this catalog, we have access to hundreds of hard-to-find tools not shown due to their specialized nature. If you're looking for a special tool, call us and we'll help you find it."

- Wendy, Goodson Purchasing, 31 years of service



7mm Black Diamond® Valves for Harley-Davidson® Engines

- **Light and strong with optimum airflow** A combination of stress analysis and flow bench testing for optimally balanced valve mass, strength and airflow characteristics.
- **Stellite tips for rocker applications** for resistance the impact and abrasive wear common in rocker arm systems. This welded Stellite can never come loose.
- **Black Diamond™ Valves** One piece forged stainless steel valves impregnated by a special German process to improve wear properties and reduce friction. Provides resistance to corrosion and superior wear.

Application	Type	Head Diameter	Stem Diameter	Tulip Radius	Tulip Angle	Overall Length	MSRP	Jobber	Order No.	Replaces
Twin Cam, Sportster & Buell®	Intake	1.980" (50.29mm)	0.2757"	0.290	25°	4.455"	\$34.31	\$23.99	20-20935	HBV-1980-7TG
	Intake	1.900" (48.26mm)	0.2757"	0.475	24°	4.455"	34.31	23.99	20-20940	HBV-1900-7TG
	Exhaust	1.610" (40.89mm)	0.2755"	0.595	25°	4.545"	34.31	23.99	20-20945	HBV-1610-7TG
Triple Groove	Exhaust	1.575" (40.05mm)	0.2755"	0.595	25°	4.560"	34.31	23.99	20-20950	HBV-1575-7TG
	Exhaust	1.575" (40.05mm)	0.2755"	0.595	25°	4.560"	34.31	23.99	20-20950	HBV-1575-7TG
Evo, Big Twin	Intake	2.020" (51.31mm)	0.3108"	0.670	25°	4.440"	34.31	23.99	20-20990	HBV-2020A
& Twin Cam	Exhaust	1.700" (43.18mm)	0.3106"	0.600	25°	4.535"	34.31	23.99	20-20960	HBV-1700A
S&S®, Screaming Eagle & Ultima®	Intake	2.020" (51.31mm)	0.3108"	0.645	25°	4.510"	34.31	23.99	20-20965	HBV-2020S
	Exhaust	1.610" (40.89mm)	0.3106"	0.750	25°	4.565"	34.31	23.99	20-20970	HBV-1610S
SE® / JIMS®	Exhaust	2.100" (53.34mm)	0.3108"	0.560	24°	4.475"	34.31	23.99	20-20955	HBV-2100
Blank Valves Ready to machine to your specs	Black	2.100" (53.34mm)	0.3108"	---	24°	4.475"	37.17	25.99	20-20980	AV2100BC
	Chrome	1.700" (43.18mm)	0.3106"	---	25°	5.700"	37.17	25.99	20-20985	AV1700BC
	Chrome	2.200" (55.88mm)	0.3108"	---	25°	5.700"	37.17	25.99	20-20975	AV2200BC

Protect Your Valuable Tooling By Storing It Properly

TRADE-MCB

QP-55350

SO-139

SO-140

SO-3600

DP-26200

DP-52120

QP-45080

C-CSB

QP-22200

QP-45080

QP-22200

QP-14200

QP-14200

Tooling Storage Supplies

Choose from a wide variety of plastic storage containers to keep your tooling clean, organized and ready to go when you need it. Clear storage cases have built-in dividers with inserts so you can customize size and arrangement of compartments.

Description	Dimensions	Jobber	Order No.
Black Case with Foam Liner	17"L x 12"W x 4" D	\$24.99	TRADE-MCB
Clear Storage Case With Dividers & Inserts	11"L x 6 ³ / ₄ "W x 2 ³ / ₈ "D	8.29	SO-139
Clear Storage Case with Dividers & Inserts	11"L x 6 ¹ / ₂ "W x 1 ³ / ₄ "D	6.99	SO-3600
Small Organizer Case with Dividers & Inserts	8 ¹ / ₂ "L x 5"W x 1 ¹ / ₂ "D	5.89	SO-140
Large Twist Tube	2 ¹ / ₂ " x 5" to 8"L	2.19	DP-52120
Small Twist Tube	1 ¹ / ₄ " x 8" to 11"L	1.99	DP-26200
Large Square Slip-Together Tube	2 ³ / ₈ " x 2 ³ / ₈ " x 14" to 25 ¹ / ₂ " L	5.89	QP-55350
Twist Tube	2" x 2" x 5 ¹ / ₂ " to 8"	1.39	QP-45080
Large Slip-Together Tube	.886" x 7.875" to 13.75"L	1.29	QP-22200
Small Slip-Together Tube	.551" x 7.875" to 13.75"L	1.19	QP-14200
Plastic Tube With Hinged Lid	1/2" dia. x 2"H	.59	C-CSB



Aircraft Extended Nose Seat Grinding Motor

- Heavy Duty Electric Motor
- Extended drive unit allows easy access to aircraft engines including Lycoming and Continental
- Spline drive for use with Sioux-Style stone holders
- Available in 110V or 220V models
- 11,500 RPM (free speed) / 6982 RPM under load
- Weighs 12 lbs.
- 3/5 HP, 7.5 AMP motor

Description	Jobber	Order No.
110V Extended Nose Unit	\$2199.99	SGL-XL110
220V Extended Nose Unit	2299.99	SGL-XL220

Aviation Valve Seat Grinding Kits

Spline Drive Seat Grinding Kit includes everything listed below. Everything comes packed in a handy storage case. Kit includes:

Description	Jobber	Order No.	Includes
110V Aviation Valve Seat Grinding Kit	\$4999.99	SAV-110-KIT	▼
220V Aviation Valve Seat Grinding Kit	4999.99	SAV-220-KIT	▼
110V Extended Drive Unit	2199.99	SGL-XL110	x
220V Extended Drive Unit	2299.99	SGL-XL220	x
Heavy Duty Valve Seat Wheel Dresser	1229.99	031-1900-02	x x
Includes .375" Top Dressing Stand Pilot	149.99	031-0202-55	
Replacement Dresser Diamond	37.99	G-18	
.375" Sioux-Style Stone Holders (NEW!)	209.99	SX-375	2 2
Heavy Duty Plastic Storage Box	51.99	SG-CASE	x x
Stone Removal Tool	24.99	SX-SRT	x x
Leather Vibration Reducers (3 Pack)	11.99	SHW-3	x x
Bounce Spring Set	16.99	BSS-100	x x
.375" Bushing Set	8.99	3D-DB7	x x
.375" Top High Speed Steel Tapered Pilots			
.343" Dia.	92.99	AP-5343	
.344" Dia.	92.99	AP-5344	
.345" Dia.	92.99	AP-5345	
.375" Dia.	92.99	AP-5375	x x
.376" Dia.	92.99	AP-5376	x x
.377" Dia.	92.99	AP-5377	
.406" Dia.	92.99	AP-5406	
.407" Dia.	92.99	AP-5407	
.408" Dia.	92.99	AP-5408	
.436" Dia.	92.99	AP-5436	
.437" Dia.	92.99	AP-5437	x x
.438" Dia.	92.99	AP-5438	x x
.439" Dia.	92.99	AP-5439	x x
.498" Dia.	92.99	AP-5498	
.499" Dia.	92.99	AP-5499	
.500" Dia.	92.99	AP-5500	x x
.501" Dia.	92.99	AP-5501	x x
.502" Dia.	92.99	AP-5502	x x
General Purpose Valve Seat Stones			
30° 1-3/4" Dia.	13.99	SX-1430-GP	x x
45° 1-3/4" Dia.	13.99	SX-1445-GP	x x
30° 2-1/2" Dia.	13.99	SX-2030-GP	x x
45° 2-1/2" Dia.	13.99	SX-2045-GP	x x
Cool Blue Valve Seat Stones			
00° 1-3/4" Dia.	13.99	SX-1400-CB	x x
00° 2-1/2" Dia.	13.99	SX-2000-CB	x x
Finishing Valve Seat Stones			
30° 1-3/4" Dia.	11.99	SX-1430-F	x x
45° 1-3/4" Dia.	11.99	SX-1445-F	x x
30° 2-1/2" Dia.	15.99	SX-2030-F	x x
45° 2-1/2" Dia.	15.99	SX-2045-F	x x

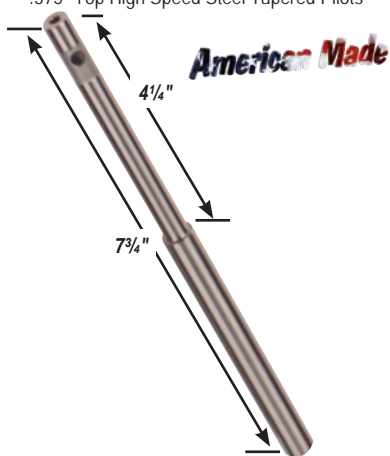

.375" Top Pilot Spline Drive Valve Seat Stone Holder

- 11/16 x 16 thread
- Use your Sioux Style stones with your .375" Top Pilots
- Order No. SX-375
- Jobber \$199.99

Extended Reach Valve Seat Run-Out Gauge for .375" Top Pilots

- Hardened guide bushings and contact point
- Quick thumb-screw set-up
- Jeweled bearing indicator reads to ± .050" with .001" precision
- Range: 1.00" to 2.50"
- OAL: 11 3/4"
- Order No. VSG-375-XL
- Jobber \$499.99



CYLINDER HEAD REBUILDING
CLEANING, ASSEMBLY & SAFETY
SHORT BLOCK REBUILDING
FLYWHEEL GRINDING
CRANKSHAFT/ MISCELLANEOUS TOOLS & SUPPLIES
BRAKE SERVICE TOOLING
MEASURING TOOLS
V-TWIN & METRIC HARD PARTS

CYLINDER HEAD REBUILDING
CLEANING, ASSEMBLY & SAFETY
SHORT BLOCK REBUILDING
CRANKSHAFT/ FLYWHEEL GRINDING
MISCELLANEOUS TOOLS & SUPPLIES
BRAKE SERVICE TOOLING
MEASURING TOOLS
V-TWIN & METRIC HARD PARTS

Table Top Ultrasonic Cleaning Machines

Ultrasonic cleaning is extremely effective at removing dirt and grime—even in the smallest of crevices. Normally, this would require tedious hand cleaning. Ultrasonic tabletop cleaning machines are ideal for cleaning here you can't go. Use for carburetors, throttle bodies, lifters, push rods, roller rockers and more.

These ultrasonic tabletop cleaning machines return your parts to an almost "like new" condition without damaging delicate parts or surfaces. It's high-performance cleaning that cleans your parts faster and cheaper than the alternatives.

Choose from the accessories listed below or call **Goodson** at **1-800-533-8010** for information on additional Ultrasonic Machine sizes.



ULTRA 1300M (USC-1300M)

ULTRA 2000M (USC-2000M)

	Ultra 1300M (USC-1300M)	Ultra 2000M (USC-2000M)
Capacity:	3.6 gallons (13.63 liters)	6 gallons (22.71 liters)
Tank Dimensions:	12.75"L x 11.5"W x 5"D 324 x 292 x 127mm	19.5"L x 11.6"W x 7"D 495 x 295 x 178mm
Working Depth:	5"D (130mm)	7"D (178mm)
Machine Dimensions:	14"L x 13"W x 13"H 355 x 330 x 330mm	21"L x 13"W x 15"H 533 x 330 x 381mm
Basket Dimensions:	11.5"L x 10.5"W x 4"H 292 x 266 x 101mm	18"L x 11"W x 4.75"H 457 x 279 x 121mm
Controls:	Manual	Manual
Ultrasonic Frequency:	33/40 kHz Sweeping	33/40 kHz Sweeping
Ultrasonic Power:	200 Watts	400 Watts
Heaters:	300 Watts	500 Watts
Electric:	120V @ 5 Amps or EU 220V	120V @ 7.5 Amps or EU 220V
Order No.	USC-1300M	USC-2000M
Jobber:	\$899.99	\$1599.99

Now 3 Formulas



Ultrasonic Detergents

- Safe for ferrous metals & aluminum
- Medium Duty can be used on plastic
- For ultrasonic immersion tanks
- Medium Duty includes rust preventive
- 5 gallons / 18.39L containers

Formula	Mix Ratio water : detergent	Uses	Jobber	Order No
Medium Duty	1:20	Metals, Plastics	\$131.99	USD-MD50
Heavy Duty	1:10	Metals, Aluminum	113.99	USD-HD50*
Caustic	1:10	Cast Iron Only	99.99	USD-CD50*

*HazMat Fee will apply

Ultrasonic Cleaning Accessories

- Ensure your ultrasonic cleaning machine performs at its peak and delivers the clean your customers demand
- **String Micron Filters**
- Available in 2 filtrations - 50 and 125 Microns
- Measure 2.5" dia. x 10"L and will fit all standard 10" filter housing units (Including models 2400FA, 3200FA, 3800FLT & 6000FLT)
- High structural strength

String Micron Filters (2 1/2" x 10"L)

Filtration	Jobber	Order No.
125 microns	\$15.99	USCF-125
50 microns	15.99	USCF-50



Oil Absorbent Tube

- Measure approximately 3" dia. x 14"L
- Use to absorb and remove excess oil from your Ultrasonic Cleaning Machine
- Replace every 4 to 12 weeks as required
- Order No. **OA-1-SM** Jobber \$14.99



Cartridge Filters

- Measure 2 7/8" x 9"L
- 2 filtration levels - 30 and 50 Microns
- Cartridge Filters will **not** fit Tabletop Ultrasonic Cleaners above

Cartridge Filters (2 7/8" x 9"L)

Filtration	Jobber	Order No.
30 microns	\$14.99	USF-30
50 microns	14.99	USF-50



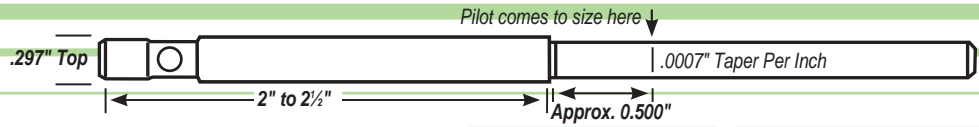

.297" Solid-Tapered High Speed Steel Pilots

Inch	mm	OAL	Order No.
.1496"	3.80	3.375"	P-1149N
.1574"	4.00	4.50"	P-1158N
.1582"	4.02	4.50"	P-1159N
.1771"	4.50	4.50"	P-1177N
Jobber			\$25.99

Inch	mm	OAL	Order No.
.1779"	4.52	4.50"	P-1178N
.1968"	5.00	4.50"	P-1197N
.1976"	5.02	4.50"	P-1198N
.2165"	5.50	4.50"	P-1216N
Jobber			\$25.99

Inch	mm	OAL	Order No.
.2173"	5.52	4.50"	P-1217N
.2362"	6.00	4.50"	P-1236N
.2370"	6.02	4.50"	P-1237N
.2381"	6.05	4.50"	P-1238N
Jobber			\$25.99

Inch	mm	OAL	Order No.
.2490"	6.32	4.50"	P-1249N
.2500"	6.35	4.50"	P-1250N
.2510"	6.37	4.50"	P-1251N
.2598"	6.60	5.25"	P-1260N
.2755"	7.00	4.50"	P-1275N
Jobber			\$25.99

Inch	mm	OAL	Order No.
.2810"	7.14	4.50"	P-1281N
.3120"	7.92	4.50"	P-1312N
.3130"	7.95	4.50"	P-1313N
.3149"	8.00	4.50"	P-1315N
.3427"	8.72	4.50"	P-1343N
Jobber			\$25.99

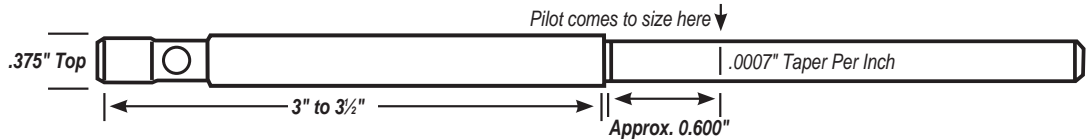

.375" Solid-Tapered High Speed Steel Pilots

Inch	mm	OAL	Order No.
.1771"	4.50	6.00"	P-5177N
.1960"	4.98	6.00"	P-5196N
.1968"	5.00	6.00"	P-5197N
.1976"	5.02	6.00"	P-5198N
.2165"	5.50	6.00"	P-5216N
.2173"	5.52	6.00"	P-5217N
.2185"	5.55	6.00"	P-5218N
.2354"	5.98	6.00"	P-5235N
.2362"	6.00	6.00"	P-5236N
.2370"	6.02	6.00"	P-5237N
.2381"	6.05	6.00"	P-5238N
.2393"	6.08	6.00"	P-5239N
Jobber			\$35.99

Inch	mm	OAL	Order No.
.2490"	6.32	6.00"	P-5249N
.2500"	6.35	6.00"	P-5250N
.2510"	6.37	6.00"	P-5251N
.2559"	6.50	6.00"	P-5256N
.2566"	6.52	6.00"	P-5257N
.2590"	6.58	6.00"	P-5258N
.2598"	6.60	6.00"	P-5260N
.2748"	6.98	6.00"	P-5274N
.2756"	7.00	6.00"	P-5275N
.2763"	7.02	6.00"	P-5277N
.2775"	7.05	6.00"	P-5278N
.2792"	7.09	6.00"	P-5279N
Jobber			\$35.99

Inch	mm	OAL	Order No.
.2952"	7.50	6.00"	P-5295N
.2960"	7.52	6.00"	P-5296N
.3095"	7.86	6.00"	P-5309N
.3105"	7.88	6.00"	P-5310N
.3115"	7.91	6.00"	P-5311N
.3125"	7.93	6.00"	P-5312N
.3135"	7.96	6.00"	P-5313N
.3145"	7.98	6.00"	P-5314N
.3149"	8.00	6.00"	P-5315N
.3165"	8.03	6.00"	P-5316N
.3397"	8.62	6.50"	P-5339N
.3407"	8.65	6.50"	P-5340N
Jobber			\$35.99

Inch	mm	OAL	Order No.
.3417"	8.67	6.50"	P-5341N
.3427"	8.70	6.50"	P-5342N
.3437"	8.72	6.50"	P-5343N
.3447"	8.75	6.50"	P-5344N
.3457"	8.78	6.50"	P-5345N
.3543"	9.00	6.50"	P-5354N
.3551"	9.02	6.50"	P-5355N
.3587"	9.11	6.50"	P-5358N
.3730"	9.47	7.00"	P-5373N
.3740"	9.49	7.00"	P-5374N
.3750"	9.52	7.00"	P-5375N
.3760"	9.55	7.00"	P-5376N
.3770"	9.57	7.00"	P-5377N
Jobber			\$35.99

Inch	mm	OAL	Order No.
.3780"	9.60	7.00"	P-5378N
.3790"	9.62	7.00"	P-5379N
.3820"	9.70	7.00"	P-5382N
.3937"	10.00	7.00"	P-5394N
.4331"	11.00	7.75"	P-5433N
.4365	11.08	7.75"	P-5436N
.4375"	11.11	7.75"	P-5437N
.4385"	11.13	7.75"	P-5438N
.4395"	11.16	7.75"	P-5439N
Jobber			\$35.99
.5000"	12.70	7.75"	P-5500N
.5010"	12.72	7.75"	P-5501N
.5020"	12.75	7.75"	P-5502N
Jobber			\$59.99

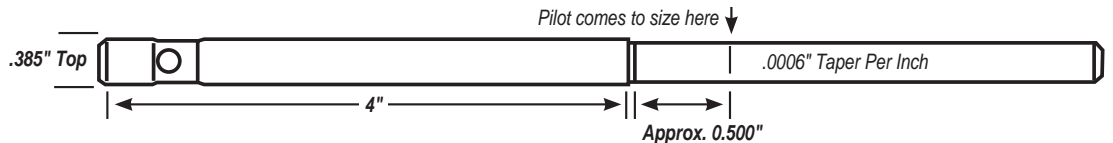

.385" Solid-Tapered High Speed Steel Pilots

Inch	mm	OAL	Order No.
.2165"	5.50	7.50"	P-5216S
.2173"	5.52	7.50"	P-5217S
.2350"	5.97	7.50"	P-5235S
.2362"	6.00	7.50"	P-5236S
.2370"	6.02	7.50"	P-5237S
.2381"	6.05	7.50"	P-5238S
.2500"	6.35	7.50"	P-5250S
Jobber			\$49.99

Inch	mm	OAL	Order No.
.2510"	6.38	7.50"	P-5251S
.2598"	6.60	7.50"	P-5260S
.2744"	6.97	7.50"	P-5274S
.2755"	7.00	7.50"	P-5275S
.2763"	7.02	7.50"	P-5276S
.2771"	7.04	7.50"	P-5277S
.2779"	7.06	7.50"	P-5278S
Jobber			\$49.99

Inch	mm	OAL	Order No.
.3100"	7.87	7.50"	P-5310S
.3125"	7.94	7.50"	P-5312S
.3130"	7.95	7.50"	P-5313S
.3141"	7.98	7.50"	P-5314S
.3149"	8.00	7.50"	P-5315S
.3161"	8.03	7.50"	P-5316S
.3170"	8.05	7.50"	P-5317S
Jobber			\$49.99

Inch	mm	OAL	Order No.
.3410"	8.66	7.50"	P-5341S
.3420"	8.68	7.50"	P-5342S
.3430"	8.71	7.50"	P-5343S
.3440"	8.73	7.50"	P-5344S
.3450"	8.76	7.50"	P-5345S
.3543"	9.00	7.50"	P-5354S
.3550"	9.02	7.50"	P-5355S
Jobber			\$49.99

Inch	mm	OAL	Order No.
.3560"	9.04	7.50"	P-5356S
.3580"	9.09	7.50"	P-5358S
.3730"	9.47	7.50"	P-5373S
.3740"	9.50	7.50"	P-5374S
.3750"	9.53	7.50"	P-5375S
.3760"	9.55	7.50"	P-5376S
Jobber			\$49.99

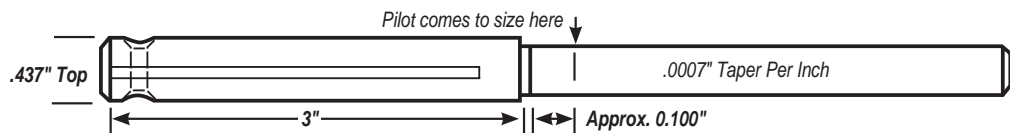

.437" Solid-Tapered High Speed Steel Pilots

Inch	mm	OAL	Order No.
.2160"	5.50	6.75"	P-5216K
.2170"	5.52	6.75"	P-5218K
.2354"	5.98	6.75"	P-5235K
.2362"	6.00	6.75"	P-5236K
.2370"	6.02	6.75"	P-5237K
.2381"	6.05	6.75"	P-5238K
Jobber			\$59.99

Inch	mm	OAL	Order No.
.2755"	7.00	6.75"	P-5275K
.2760"	7.02	6.75"	P-5276K
.2775"	7.05	6.75"	P-5277K
.2787"	7.08	6.75"	P-5279K
.3115"	7.90	6.75"	P-5311K
.3125"	7.94	6.75"	P-5312K
Jobber			\$59.99

Inch	mm	OAL	Order No.
.3135"	7.96	6.75"	P-5313K
.3145"	7.98	6.75"	P-5314K
.3150"	8.00	6.75"	P-5315K
.3157"	8.02	6.75"	P-5316K
.3169"	8.05	6.75"	P-5317K
.3417"	8.68	6.75"	P-5341K
Jobber			\$59.99

Inch	mm	OAL	Order No.
.3427"	8.70	6.75"	P-5342K
.3437"	8.73	6.75"	P-5343K
.3440"	8.74	8.00"	P-5344K
.3457"	8.78	6.75"	P-5345K
.3587"	9.09	6.75"	P-5358K
Jobber			\$59.99

Inch	mm	OAL	Order No.
.3730"	9.47	6.75"	P-5373K
.3740"	9.50	6.75"	P-5374K
.3750"	9.52	6.75"	P-5375K
Jobber			\$59.99



.375" Top Expanding Pilots

• Expand up to .020" (.51mm) • Includes Collet & Expander

Size	mm	Range	Pilot	Collet	Expander
.216"	5.50	.213"-.233"	P-5.5MMNX	P-216-COLLET	P-1216-EXP
.236"	6.00	.233"-.253"	P-6MMNX	P-6MM-COLLET	P-1236-EXP
.250"	6.35	.247"-.267"	P-250NX	P-250-COLLET	P-1250-EXP
.256"	6.50	.253"-.273"	P-6.5MMNX	P-65MM-COLLET	P-6.5MM-EXP
.275"	7.00	.272"-.292"	P-7MMNX	P-7MM-COLLET	P-7MM-EXP
.312"	7.92	.309"-.329"	P-312NX	P-312-COLLET	P-343-EXP
.335"	8.50	.330"-.350"	P-8.5MMNX	P-343-COLLET	P-343-EXP
.343"	8.70	.340"-.360"	P-343NX	P-343-COLLET	P-343-EXP
.354"	9.00	.350"-.370"	P-9MMNX	P-375-COLLET	P-375-EXP
.375"	9.50	.372"-.392"	P-375NX	P-375-COLLET	P-375-EXP
.393"	10.00	.390"-.410"	P-10MMNX	P-10MM-COLLET	P-10MM-EXP
.437"	11.00	.430"-.450"	P-11MMNX	P-11MM-COLLET	P-11MM-EXP
.453"	11.50	.450"-.470"	P-453NX	P-11MM-COLLET	P-11MM-EXP
.472"	12.00	.469"-.489"	P-12MMNX	P-12MM-COLLET	P-12MM-EXP
Jobber			\$51.99	\$18.99	\$10.99

.375" Extended Length Expanding Pilots

• Expand up to .020" (.51mm) • Comes with Collet & Expander • High Speed Steel

Size	mm	Range	Pilot	Collet	Expander
.3120"	7.92	.309"-.329"	P-312NXL	P-312L-COL	P-343-EXP
.3430"	8.71	.340"-.360"	P-343NXL	P-343L-COL	P-343-EXP
.3750"	9.52	.372"-.392"	P-375NXL	P-375L-COL	P-375-EXP
Jobber			\$56.99	\$18.99	\$10.99

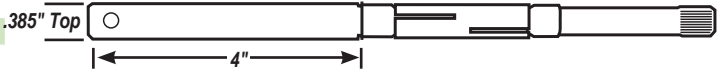

.385" Top Expanding Pilots

• Expand up to .020" (.51mm) • Includes Collet & Expander

Size	mm	Range	Pilot	Collet	Expander
.236"	6.00	.233"-.253"	P-6MMSX	P-6MM-COLLET	P-1236-EXP
.250"	6.35	.247"-.267"	P-250SX	P-250-COLLET	P-1250-EXP
.256"	6.50	.253"-.273"	P-6.5MMSX	P-65MM-COLLET	P-6.5MM-EXP
.275"	7.00	.272"-.292"	P-7MMSX	P-7MM-COLLET	P-7MM-EXP
.281"	7.10	.278"-.298"	P-281SX	P-281-COLLET	P-281-EXP
.295"	7.50	.290"-.310"	P-7.5MMSX	P-281-COLLET	P-281-EXP
.312"	7.92	.309"-.329"	P-312SX	P-312-COLLET	P-343-EXP
.335"	8.50	.330"-.350"	P-8.5MMSX	P-343-COLLET	P-343-EXP
.343"	8.70	.340"-.360"	P-343SX	P-343-COLLET	P-343-EXP
.354"	9.00	.350"-.370"	P-9MMSX	P-375-COLLET	P-375-EXP
.375"	9.50	.372"-.392"	P-375SX	P-375-COLLET	P-375-EXP
.393"	10.00	.390"-.410"	P-10MMSX	P-10MM-COLLET	P-10MM-EXP
.406"	10.30	.403"-.423"	P-406SX	P-10MM-COLLET	P-10MM-EXP
.437"	11.00	.430"-.450"	P-11MMSX	P-11MM-COLLET	P-11MM-EXP
.453"	11.50	.450"-.470"	P-453SX	P-11MM-COLLET	P-11MM-EXP
.472"	12.00	.469"-.489"	P-12MMSX	P-12MM-COLLET	P-12MM-EXP
.500"	12.70	.497"-.517"	P-500SX	P-12MM-COLLET	P-12MM-EXP
Jobber			\$92.99	\$18.99	\$10.99



.437" Top Expanding Pilots

• Expand up to .020" (.51mm) • Includes Collet & Expander

Size	mm	Range	Pilot	Collet	Expander
.236"	6.00	.233"-.253"	P-6MMKX	P-6MM-COLLET	P-1236-EXP
.275"	7.00	.272"-.292"	P-7MMKX	P-7MM-COLLET	P-7MM-EXP
.312"	7.92	.309"-.329"	P-312KX	P-312-COLLET	P-343-EXP
.343"	8.70	.340"-.360"	P-343KX	P-343-COLLET	P-343-EXP
.375"	9.50	.372"-.392"	P-375KX	P-375-COLLET	P-375-EXP
.453"	11.50	.450"-.470"	P-453KX	P-11MM-COLLET	P-11MM-EXP
Jobber			\$61.99	\$18.99	\$10.99

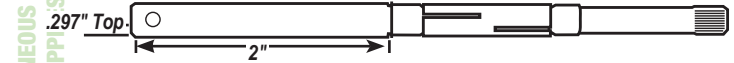

.297" Top Expanding Pilots

• Expand up to .020" (.51mm) • Comes with Collet & Expander • High Speed Steel

Size	mm	Range	Pilot	Collet	Expander
.2165"	5.50	.213"-.233"	P-1216NX	P-216-COLLET	P-1216-EXP
.2362"	6.00	.233"-.253"	P-1236NX	P-6MM-COLLET	P-1236-EXP
.2500"	6.35	.247"-.267"	P-1250NX	P-250-COLLET	P-1250-EXP
.2756"	7.00	.275"-.294"	P-1275NX	P-275-COLLET	P-275-EXP
.2810"	7.14	.278"-.298"	P-1281NX	P-281-COLLET	P-1281-EXP
.3120"	7.92	.309"-.329"	P-1312NX	P-312-COLLET	P-1312-EXP
.3149"	8.00	.312"-.332"	P-1315NX	P-312-COLLET	P-1315-EXP
Jobber			\$51.99	\$18.99	\$10.99

tech tips
from the techxperts™

Caring For Your Pilots

Pilots are a major investment for your shop so it pays to take proper care of them. Here are some quick tips ...

- 1 Keep your pilots clean. Be sure to clean off any debris when you are finished with your job.
- 2 Cover the pilot with a light coat of oil prior to storage to keep rust at bay.
- 3 Store your pilots to ensure they don't roll around and bang into each other to cause damage.
- 4 Always check your pilots of size and straightness before starting a new project.

Take care of your pilots and they will take care of you!

Setting your expanding pilot

tech tips
from the techxperts™

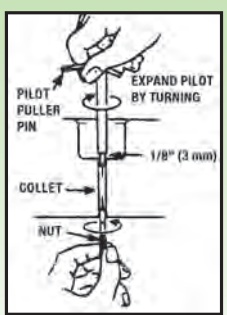

- 1 Select an expanding pilot that is the same diameter as the valve guide ID.
- 2 Insert the pilot into the valve guide making sure that the expanding section of the pilot (collet) is completely within the valve guide. The pilot will not center properly and may be damaged if the collet extends outside of the valve guide.
- 3 Pilot shoulder should be about 1/8" above the valve guide.
- 4 Turn the pilot while holding the nut at the opposite end. This will expand the collet and secure the pilot into position.

NOTE: DO NOT use Expanding Pilots with multi-angle valve seat cutting systems (ie: 3-D Fast Cut)



.236" Top Tapered Carbide Pilots

- Less deflection under stress • Due to the brittle nature of carbide we can only warranty carbide pilots for size

Inch	mm	Order No.	Inch	mm	Order No.	Inch	mm	Order No.
.1559"	3.96	PCT-1560M	.1968"	5.00	PCT-1970M	.2560"	6.50	PCT-2560M
.1566"	3.98	PCT-1570M	.1980"	5.03	PCT-1980M	.2570"	6.53	PCT-2570M
.1575"	4.00	PCT-1575M	.2161"	5.49	PCT-2160M	.2578"	6.55	PCT-2580M
.1578"	4.01	PCT-1580M	.2170"	5.52	PCT-2170M	.2590"	6.58	PCT-2590M
.1759"	4.47	PCT-1760M	.2181"	5.54	PCT-2180M	.2598"	6.60	PCT-2600M
.1771"	4.50	PCT-1770M	.2350"	5.97	PCT-2350M	.2756"	7.00	PCT-2756M
.1779"	4.52	PCT-1780M	.2358"	5.99	PCT-2360M	.2759"	7.01	PCT-2760M
.1960"	4.98	PCT-1960M	.2370"	6.02	PCT-2370M	.2763"	7.02	PCT-2765M
Jobber	\$199.99		Jobber	\$199.99		.2771"	7.04	PCT-2770M
						Jobber	\$199.99	



.375" Top Tapered Carbide Pilots

Inch	mm	Order No.	Inch	mm	Order No.	Inch	mm	Order No.
.1575"	4.00	PCT-1575	.2370"	6.02	PCT-2370	.3150"	8.00	PCT-3150
.1771"	4.50	PCT-1770	.2598"	6.60	PCT-2600	.3422"	8.70	PCT-3420
.1968"	5.00	PCT-1970	.2756"	7.00	PCT-2756	.3433"	8.72	PCT-3430
.2165"	5.50	PCT-2165	.2759"	7.01	PCT-2760	.3440"	8.73	PCT-3440
.2173"	5.52	PCT-2170	.2763"	7.02	PCT-2765	.3728"	9.47	PCT-3730
.2362"	6.00	PCT-2362	.2771"	7.04	PCT-2770	.3740"	9.50	PCT-3740
Jobber	\$199.99		.3122"	7.93	PCT-3120	Jobber	\$199.99	
			Jobber	\$199.99				

tech tips

from the techxperts™

When choosing a pilot, first decide if you need a "live" pilot (one which turns with the tooling) or "dead" pilot (one which remains stationary in the bore). Choose the top size, then the guide bore size.

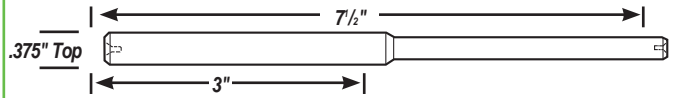

.375" Top Serdi-Style (Live) Straight Carbide Pilots

- For applications where the pilot must turn with the tooling
- Solid carbide construction
- Due to the brittle nature of carbide, Goodson can only warranty these carbide pilots for size

Inch	mm	Order No.	Inch	mm	Order No.	Inch	mm	Order No.
.1571"	3.99	PCS-399	.2600"	6.61	PCS-661	.3157"	8.02	PCS-802
.1767"	4.49	PCS-449	.2752"	6.99	PCS-699	.3425"	8.70	PCS-870
.1771"	4.50	PCS-450	.2756"	7.00	PCS-700	.3433"	8.72	PCS-872
.1960"	4.98	PCS-498	.2760"	7.01	PCS-701	.3437"	8.73	PCS-873
.1964"	4.99	PCS-499	.2764"	7.02	PCS-702	.3440"	8.74	PCS-874
.1968"	5.00	PCS-500	.2768"	7.03	PCS-703	.3720"	9.45	PCS-945
.2157"	5.48	PCS-548	.2771"	7.04	PCS-704	.3724"	9.46	PCS-946
.2161"	5.49	PCS-549	.3110"	7.90	PCS-790	.3728"	9.47	PCS-947
.2165"	5.50	PCS-550	.3114"	7.91	PCS-791	.3732"	9.48	PCS-948
.2354"	5.98	PCS-598	.3118"	7.92	PCS-792	.3736"	9.49	PCS-949
.2358"	5.99	PCS-599	.3122"	7.93	PCS-793	.3744"	9.51	PCS-951
.2362"	6.00	PCS-600	.3130"	7.95	PCS-795	.3748"	9.52	PCS-952
.2368"	6.01	PCS-601	.3146"	7.99	PCS-799	Jobber	\$199.99	
.2559"	6.50	PCS-650	.3150"	8.00	PCS-800			
.2594"	6.59	PCS-659	.3154"	8.01	PCS-801			
Jobber	\$199.99		Jobber	\$199.99				

tech tips

from the techxperts™

We get asked from time to time why Goodson carries so many sizes and styles of pilots.

Most of us probably think of that in terms of Top and Bottom Size, but there's another dimension that's becoming more important every day. The pilot's top length.

You've probably worked on (or at least seen) heads with deeply set valves. This is especially common in diesel applications. Some of them are set so deeply that a standard pilot just won't cut it. You need a pilot that extends above the deck while still being fully seated in the guide in order to perform top quality seat work.

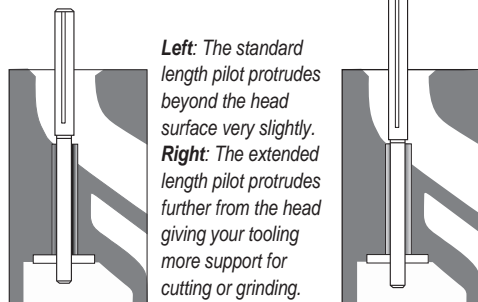

Left: The standard length pilot protrudes beyond the head surface very slightly. Right: The extended length pilot protrudes further from the head giving your tooling more support for cutting or grinding.

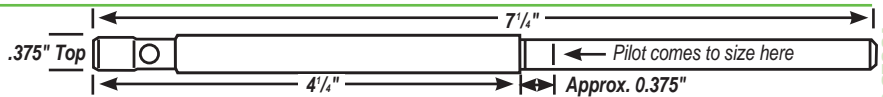

Extended Length .375" Top Solid-Tapered High Speed Steel Pilots

Inch	mm	OAL	Order No.	Inch	mm	OAL	Order No.	Inch	mm	OAL	Order No.
.2165"	5.50	7.25"	P-5217NL	.3115"	7.91	7.25"	P-5311NL	.3447"	8.75	7.75"	P-5344NL
.2173"	5.52	7.25"	P-5218NL	.3125"	7.93	7.25"	P-5312NL	.3457"	8.78	7.75"	P-5345NL
.2362"	6.00	7.25"	P-5236NL	.3135"	7.95	7.25"	P-5313NL	.3730"	9.47	7.75"	P-5373NL
.2370"	6.02	7.25"	P-5237NL	.3145"	7.98	7.25"	P-5314NL	.3740"	9.50	7.75"	P-5374NL
.2598"	6.60	7.25"	P-5260NL	.3150"	8.00	7.25"	P-5315NL	.3750"	9.52	7.75"	P-5375NL
.2606"	6.62	7.25"	P-5261NL	.3157"	8.02	7.25"	P-5316NL	.3760"	9.55	7.75"	P-5376NL
.2755"	7.00	7.25"	P-5275NL	.3417"	8.68	7.75"	P-5341NL	.3820"	9.70	7.75"	P-5382NL
.2756"	7.01	7.25"	P-5276NL	.3427"	8.70	7.75"	P-5342NL	Jobber		\$59.99	
.3105"	7.88	7.25"	P-5310NL	.3437"	8.73	7.75"	P-5343NL				
Jobber		\$59.99		Jobber		\$59.99					

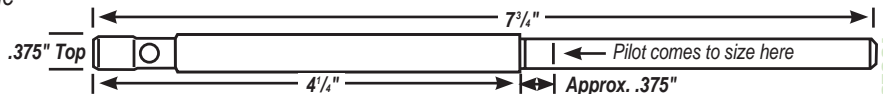

.375" Top Solid-Tapered High Speed Steel Pilots For Aircraft Work

Inch	mm	OAL	Order No.	Inch	mm	OAL	Order No.	Inch	mm	OAL	Order No.
.343"	8.72	7.75"	AP-5343	.406"	10.31	7.75"	AP-5406	.439"	11.15	7.75"	AP-5439
.344"	8.75	7.75"	AP-5344	.407"	10.34	7.75"	AP-5407	.498"	12.12	7.75"	AP-5498
.345"	8.78	7.75"	AP-5345	.408"	10.36	7.75"	AP-5408	.499"	12.67	7.75"	AP-5499
.375"	9.52	7.75"	AP-5375	.436"	11.07	7.75"	AP-5436	.500"	12.70	7.75"	AP-5500
.376"	9.55	7.75"	AP-5376	.437"	11.10	7.75"	AP-5437	.501"	12.73	7.75"	AP-5501
.377"	9.57	7.75"	AP-5377	.438"	11.12	7.75"	AP-5438	.502"	12.75	7.75"	AP-5502
Jobber		\$92.99		Jobber		\$92.99		Jobber		\$92.99	

CYLINDER HEAD REBUILDING
CLEANING, ASSEMBLY & SAFETY
SHORT BLOCK REBUILDING
FLYWHEEL GRINDING
CRANKSHAFT/ MISCELLANEOUS TOOLS & SUPPLIES
BRAKE SERVICE TOOLING
MEASURING TOOLS
V-TWIN & METRIC HARD PARTS

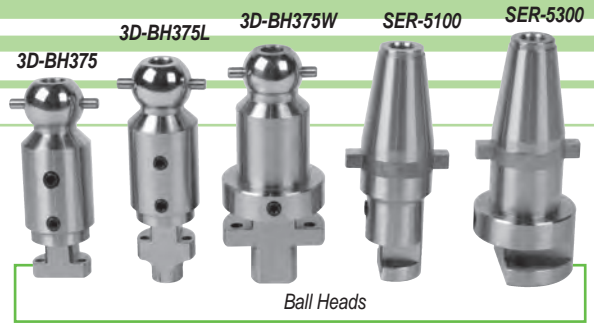
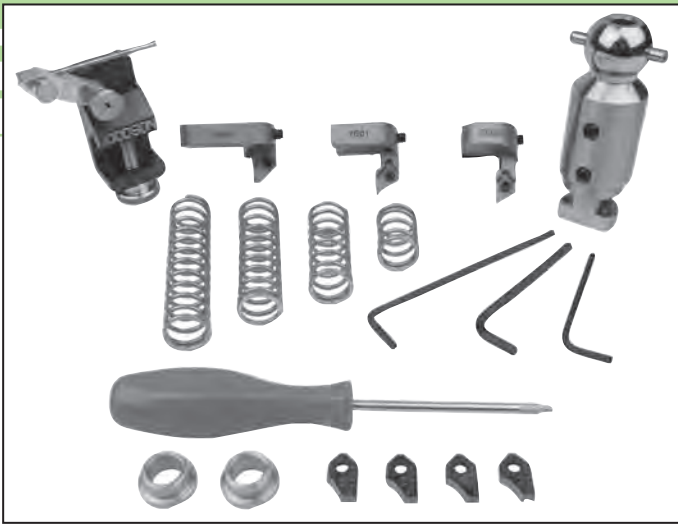

3-D Fast Cut™ Starter Kits

- Can be used with your existing pilots • Ball heads are available to fit most common seat grinder pilots • Choose from over 100 3-angle blade profiles on pages 6-9
- Fully compatible with most popular 3-angle cutting systems including Kwik-Way, Peterson, Rottler, Serdi, Sunnen, T&S, Winona Van Norman, Newen, etc.

Description	Fits Pilot	Jobber	Order No.	Includes
Complete Starter Kits	.375" / 9.53mm	\$999.99	3D-375-KIT	▼
(see page 1 for our selection of pilots)	.385" / 9.78mm	999.99	3D-385-KIT	▼
	.390" / 9.90mm	999.99	3D-390-KIT	▼
	.437" / 11.10mm	999.99	3D-437-KIT	▼
Ball Head Standard	.375" / 9.53mm	229.99	3D-BH375	x
3.346" long	.385" / 9.78mm	229.99	3D-BH385	x
3/8" channel fits most	.390" / 9.90mm	229.99	3D-BH390	x
3-angle systems	.437" / 11.10mm	229.99	3D-BH437	x
Ball Head Extended	.375" / 9.53mm	264.99	3D-BH375L	x
Length 3.80" long				
Ball Head Wide Body	.375" / 9.53mm	389.99	3D-BH375W	
4.0625" long				
Serdi-Style Tool Bodies Use with Serdi-style pilots (page 3)				
4" long	Standard .375" / 9.53mm	329.99	SER-5100	
	Large Body .375" / 9.53mm	409.99	SER-5300	
Tip Holders	.709" - 1.181" / 18-30mm Range	179.99	3D-2000	x x x x
	1.02" - 1.653" / 26-42mm Range	179.99	3D-2001	x x x x
	1.575" - 2.362" / 40-60mm Range	179.99	3D-2002	x x x x
Tip Holders-Wide Body	1.575" - 2.362" / 40-60mm Range	253.99	3D-2003	
	2.385" - 3.150" / 58-80mm Range	264.99	3D-2004	
Cutters	45°/1.0mm	29.99	FT-45039V1	x x x x
	45°/1.3mm	29.99	FT-45051V1	x x x x
more on pages 6 - 9	45°/1.5mm	29.99	FT-45059V1	x x x x
	45°/1.9mm	29.99	FT-45075V1	x x x x
Tool Setting Fixture		144.99	3D-TSFA	x x x x
Cutter Blade Mounting Screw		5.99	FT-SCREW	x x x x
Blade Wrench		10.99	FT-WRENCH	x x x x
Automotive Spring Set (4 Pc.)		24.99	3D-SS4	x x x x
Bushing Set (1 pair)	.375"	8.99	3D-DB7	
	.385"	8.99	3D-DB6	x x
	.437"	8.99	3D-DB5	x
Ball Head	#3 Morse Taper Driver	369.99	3D-CM3	
Drive Adaptors	#4 Morse Taper Driver	369.99	3D-CM4	
	Bridgeport & DCM Driver	314.99	3D-3/4SS	
3-D Fast Cut™ Accessories				
Lift Clip for Enhanced Control, especially on Spring Pad Cutters (pg. 10)		\$22.99	3D-CLIP	
Replacement 1/8" Hex Key		1.99	3D-1/8	x x x x
Replacement 2.5mm Hex Key		1.99	3D-2.5	x x x x
Replacement 3/16" Hex Key		1.99	3D-3/32	x x x x
Replacement Screws for NWN Ball Head Base (5) - metric		1.99	MGA-4X5MM	
Replacement Screw for 3D Ball Head Base - SAE 10x32		5.99	3D-BH1032	
Adjusting Screw for Holder #3D-2000, OAL: .395" /10mm		5.99	3D-2000-S	
Adjusting Screw for Holder #3D-2001, OAL: .475" /12mm		5.99	3D-2001-S	
Adjusting Screw for Holder #3D-2002, OAL: .625" /15.9mm		5.99	3D-2002-S	

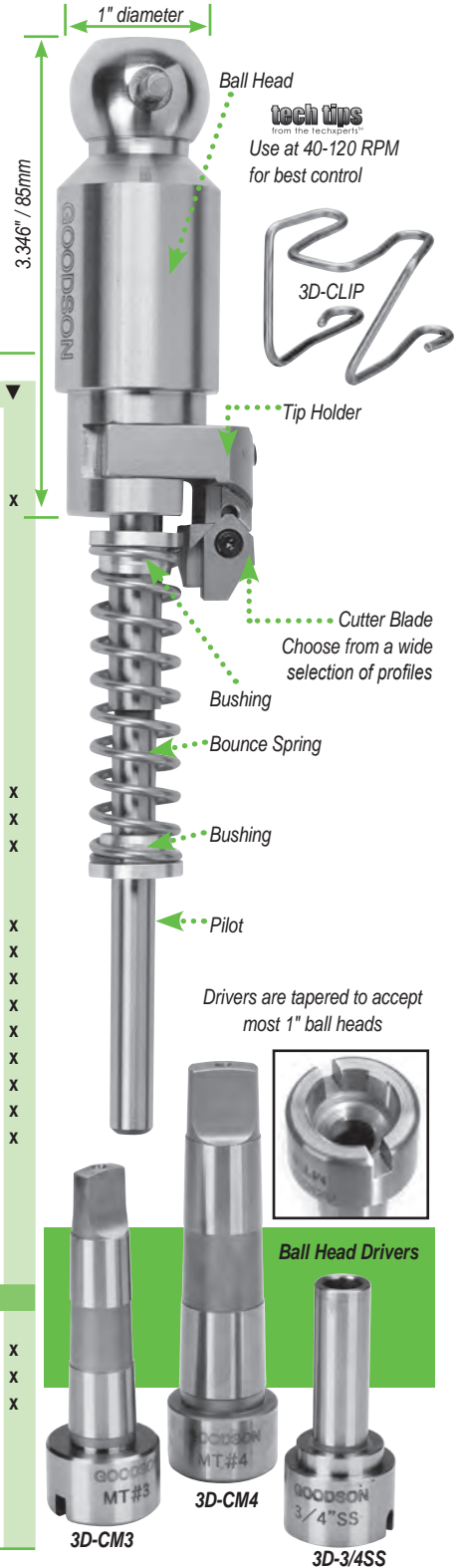

See page 5 for our Valve Seat Removal Tooling for the 3-D Fast Cut™ System

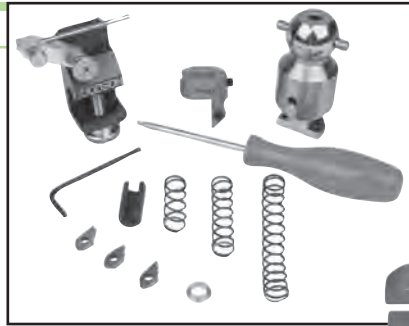

Holders (3DH-1995 & 3DH-1999M) have been modified to provide support to cutters without interfering with the bowl diameter.

Micro Tips FTM-190 and FTM-82R6B-HP only fit Tip Holder 3DH-1995



3-D Fast Cut
Honda Clone Kit

new

3-D Fast Cut™ System Micro Ball Head Tooling

- Fits the same 1" ball head driver as the original 3-D Fast Cut tooling
- Honda Clone Kit (3D-CLONE-KIT) is sized for 6.5HP Honda GX200 or X Clone DUCAR Race stock motors
- See page 3 for .236" Top Pilots

Description		Jobber	Order No.	
Micro Ball Head Starter Kit		\$ 699.99	3D-236-KIT	▼
Honda Kart Motor Clone Kit		1129.99	3D-CLONE-KIT	▼
3D Ball Head for .236"/6mm Pilot (2.56"L)		219.99	3D-BH236	x x
Micro Cutter Tips	45°/1.0mm	43.99	FTM-185	x
See pg. 7	45°/1.0mm	43.99	FTM-187	x
for profiles	39°/1.0mm	43.99	FTM-188	x
	90° (For counterboring)	43.99	FTM-190	
	82° Radius Cutter	43.99	FTM-82R6B-HP	
Cutter Tips	45°/1.0mm	39.99	FT-5043A-HD	x
See pg. 7	45°/1.0mm	39.99	IFT-4524A-HD	x
Tip Holders	.550"-.984" Range	189.99	3DH-1999M	x
	.551"-.850" Range	189.99	3DH-1995	
Bounce Springs	Short 1.050" / 26.7mm	13.49	3D-BS1	x x
	Medium 1.540" / 39.2 mm	13.49	3D-BS3	x x
	Long 2.550" / 64.8 mm	13.49	3D-BS2	x x
Bounce Spring Bushing (2)		8.99	3D-BB1	x x
Bounce Spring Spacer	22mm long	31.99	3D-BB2	x x
Carbide Pilot	.2170" dia., .236" Top	199.99	PCT-2170M	x
Valve Guide Level	3" long vial	199.99	VGL-100	x
3-D Fast Cut™ Accessories				
Replacement 2.5mm Hex Key		1.99	3D-2.5	x x
Replacement Screws for Ball Head		5.99	3D-BH1032	
Cutter Blade Mounting Screw		5.99	FT-SCREW	x x
Blade Wrench		10.99	FT-WRENCH	x x
Tool Setting Fixture		144.99	3D-TSFA	x x
Setting Micrometer for Counterbore Cutting		226.99	3DM-236	
Bridgeport / DCM Ball Head Driver		314.99	3D-3/4SS	

3-D
FAST
CUT™
SYSTEM

3-D
FAST
CUT™
SYSTEM

Valve Seat Removal Tooling

- Fits most popular 3-angle cutting tools including our popular 3-D Fast Cut™ System, Kwik-Way, Peterson, Rottler, Serdi, T&S, Winona Van Norman, Newen, etc.
- Use to relieve press fit for easier seat removal
- Requires a minimum of 2 cuts
- For precise set up use MGA-MIC (below)
- Tip Holders include one cutting tip and mounting screw (see chart below)
- Replacement tips and screws sold separately
- Ball Head and Drive Tools sold separately (see page 4)

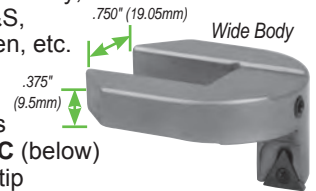
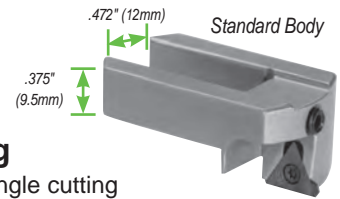

Description	Replacement Tip	Jobber	Order No.	
Tip Holders	3DB-1999i	\$243.99	3D-1999C	
	3DB-250	243.99	3D-2000C	
	3DB-250	243.99	3D-2001C	
	3DB-250	243.99	3D-2002C	
	3DB-250	334.99	3D-2003C	
Wide Body Tip Holders	3DB-250	334.99	3D-2004C	
	3DB-250	334.99	3D-2004C	
Replacement Tip		41.99	3DB-1999i	
		39.99	3DB-250	
Replacement Screw	for 3DB-1999i	14.99	3DB-1999S	
	for 3DB-250	12.99	3DS-SCREW	
tech tips				
	Cutting Range with Pilot Size		tech tips	
Holder	.236" Top	.375" Top	.385" Top	.437" Top
3D-1999C	0.960"-1.225"	1.095"-1.360"	1.105"-1.360"	1.157"-1.360"
3D-2000C	1.056"-1.480"	1.194"-1.480"	1.206"-1.480"	1.264"-1.480"
3D-2001C		1.376"-2.000"	1.386"-2.000"	1.450"-2.000"
3D-2002C		1.524"-2.460"	1.544"-2.460"	1.610"-2.460"
3D-2003C		1.680"-2.400"	1.680"-2.400"	
3D-2004C		2.280"-3.200"	2.280"-3.200"	

3-D Fast Cut Setting Micrometers

- Accurate to .001"
- Standard micrometer uses tapered .375" Pilot to match your ball head (sold separately, page 1)
- Use to set cutting diameter of 90° carbide cutters when modifying counterbores

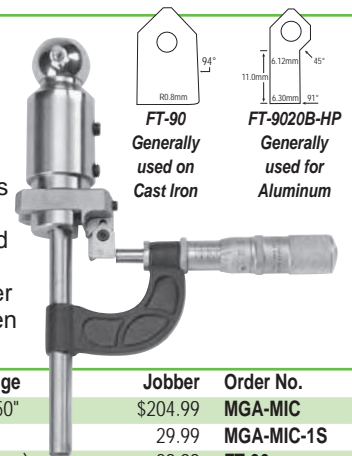

Description	Cutting Range	Jobber	Order No.
Standard Micrometer	1.000" - 2.650"	\$204.99	MGA-MIC
Setting Standard		29.99	MGA-MIC-1S
90° Cutter (generally used for Cast Iron)		29.99	FT-90
90° Cutter (generally used for Aluminum)		39.99	FT-9020B-HP

Micro Setting Micrometer

- Use with .236" Pilot (PCT-2360M)

Description	Cutting Range	Jobber	Order No.
Micro Micrometer	0.236" - 2.000"	\$226.99	3DM-236
90° Micro Cutter		43.99	FTM-190
Pilot		199.99	PCT-2360M

CYLINDER HEAD
REBUILDING

CLEANING,
ASSEMBLY & SAFETY

SHORT BLOCK
REBUILDING

FLYWHEEL GRINDING
CRANKSHAFT/
MISCELLANEOUS

TOOLS & SUPPLIES

TOOLING

TOOLING

MEASURING
TOOLS

V-TWIN & METRIC
HARD PARTS

Cutter Key:

I Intake
E Exhaust
S Specialty

Mondello Signature Series Cutter Blades Add 10 to 20 CFM to Cylinder Heads

Designed to increase airflow by as much as 20 CFM, these cutters are intended for certain applications. Generally you should use intake cutters on intakes and exhaust on exhausts, but as with most things, there's always an exception. Experiment to find the right combination for you and your customers.

All Cutters This Page Jobber \$39.99 each



<p>I IFT-30B-HP</p>	<p>I IFT-4560B-HP</p>	<p>I IFT-4539B-HP</p>	
<p>E IFT-4524-HD</p>	<p>E IFT-4524A-HD</p>	<p>I IFT-4560-HD</p>	
<p>I IFT-4560A-HD</p>	<p>E IFT-4556B-HP</p>	<p>I EFT-5060B-HP</p>	
<p>I EFT-5061B-HP</p>	<p>I IFT-5065B-HP</p>	<p>I EFT-5046B-HP</p>	
<p>E IFT-5025B-HP</p>	<p>I EFT-5567B-HP</p>	<p>E EFT-5557B-HP</p>	
<p>I EFT-5550B-HP</p>	<p>I EFT-5565B-HP</p>	<p>S IFT-1056-HD</p>	
<p>S IFT-1556-HD</p>	<p>S IFT-1043-HD</p>	<p>I IFT-45B-HP</p>	
<p>S IFT-86RB-HP</p>	<p>S IFT-82R6B-HP</p>	<p>I IFT-4539B-HP Intake</p>	
<p>S IFT-75R6B-HP</p>	<p>E RBP-RR4</p>	<p>I IFT-75R6B-HP Follow up Intake</p>	
<p>I IFT-4524-HD Exhaust</p>	<p>Illustration courtesy of Air Flow Research</p> <p>Enlarged to show details</p>		
<h3>3-Pc. Set High Performance Valve Seat Cutters</h3> <ul style="list-style-type: none"> • Increase flow & improve horsepower with this set • Machine your intake seat with IFT-4539B-HP then use cutter IFT-75R6B-HP to machine below the seat and blend into the port • On exhaust, machine with IFT-4524-HD • Order No. IFT-HP-SET Jobber \$99.99 			<p>View the Airflow Illustration in color on the Goodson Blog. Scan the code for a direct link or search the blog for "airflow".</p>

Radius Profile Seat Cutter Blades

3-D Fast Cut Tool Holder

- Use when sharpening cutter blades to keep the cutter in the correct position
- Order No. **3D-HOLDER** Jobber \$39.99



Custom Cutter Blades Are Easy As 1-2-3!

- 1 Download the Goodson Custom Formtool Profile Form from our website (<https://goodson.com/collections/valve-seat-cutter-blades>) or call us to have us send you a copy.
- 2 Complete the form, including a drawing of the cutter you need. Be sure to include all angles, radii, seat widths, etc. Missing information will delay your cutter or result in an incorrect profile.
- 3 Send your completed form to Goodson. Fax: 888-466-3909 or E-mail it to orderdesk@goodson.com. We'll get a blueprint made which you will need to approve before we start production. Custom Cutter Prices start at \$98



Diamond Hand Files

- Choose between 360 & 600 grit
- Use for fine touch-ups on your Seat Cutter Blades

Description	Jobber	Order No.
Diamond File	\$64.99	DFS-2
Set -1-360 grit & 1-600 grit		
600 Grit Files (2-pack)	64.99	DFS-6

Cutter Key:

- Intake
- Exhaust
- Specialty

Turn the Page for More Valve Seat Cutter Blades

Cutter Blades This Page
Jobber \$39.99
Micro Cutter Blades
Jobber \$43.99

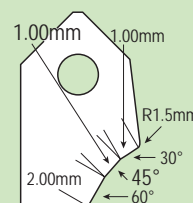

I FT-5043A-HD

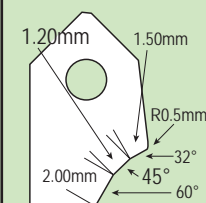

I FT-4247A-HD

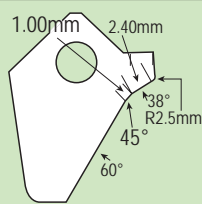

I FT-068B-HP

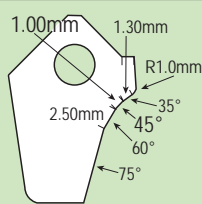

I FT-069B-HP

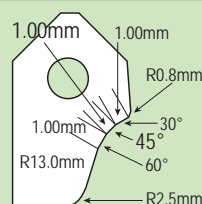

I FT-5118A-HP

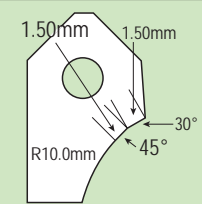

I FT-5119A-HP

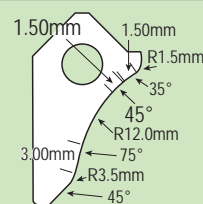

E FT-003B-HP

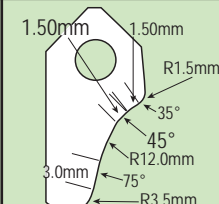

E FT-004B-HP

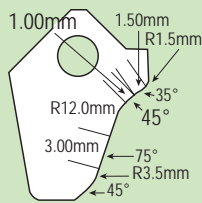

E FT-005B-HP

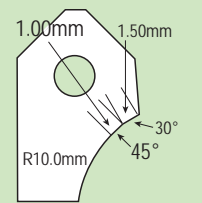

E FT-5120A-HP

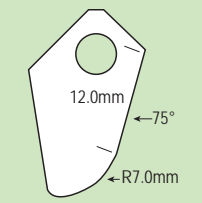

S FT-002B-HP

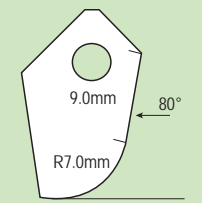

S FT-033B-HP

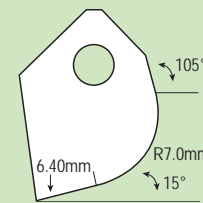

S FT-077B-HP

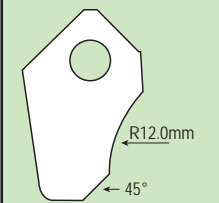

S FT-084B-HP

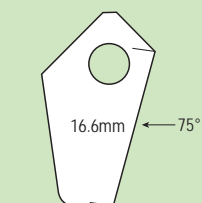

S FT-085B-HP

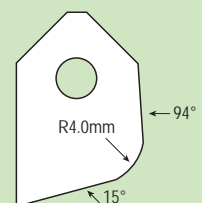

S FT-5121A-HP

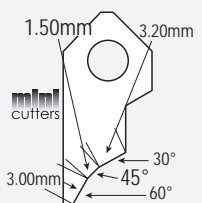

S FT-213B-HP

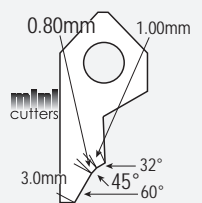

S FT-215B-HP

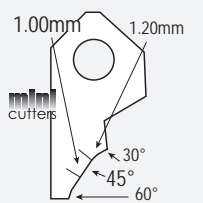

S FT-4028B-HP

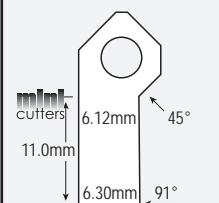

S FT-9020B-HP

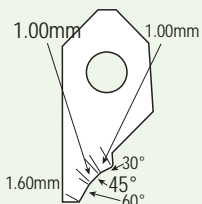

S FTM-185

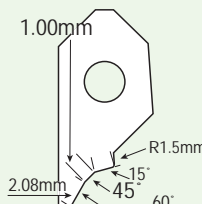

S FTM-187

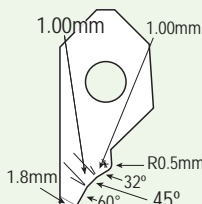

S FTM-188

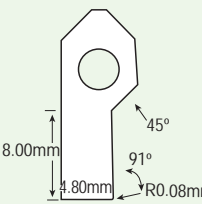

S FTM-190

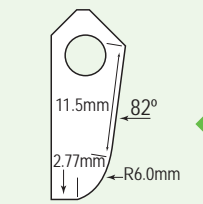

S FTM-82R6B-HP

Micro Blades

Work with holders on page 5
Jobber \$43.99 ea.

CYLINDER HEAD REBUILDING
CLEANING, ASSEMBLY & SAFETY
SHORT BLOCK REBUILDING
FLYWHEEL GRINDING
CRANKSHAFT/ MISCELLANEOUS TOOLS & SUPPLIES
BRAKE SERVICE TOOLING
MEASURING TOOLS
V-TWIN & METRIC HARD PARTS

3-D Multi-Angle Seat Cutter Blades

CYLINDER HEAD
REBUILDING

CLEANING,
ASSEMBLY & SAFETY

SHORT BLOCK
REBUILDING

CRANKSHAFT/
FLYWHEEL GRINDING

MISCELLANEOUS
TOOLS & SUPPLIES

BRAKE SERVICE
TOOLING

MEASURING
TOOLS

V-TWIN & METRIC
HARD PARTS

45° Seat Angle Cutter Blades \$29.99 each

30° Seat Angle Cutter Blades \$29.99 each

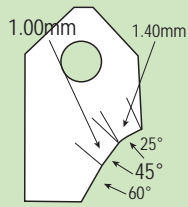

FT-45039U1

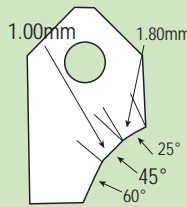

FT-45039U2

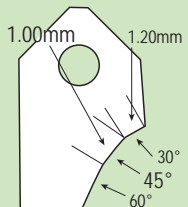

FT-45039V1

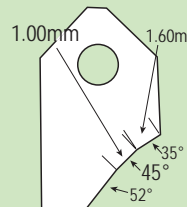

FT-45039W1

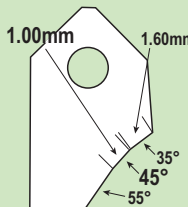

FT-45039W2

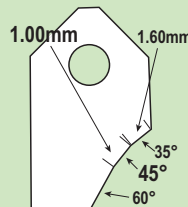

FT-45039W3

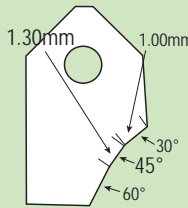

FT-45051V2

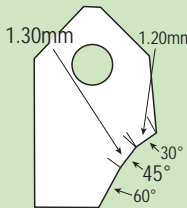

FT-45051V4

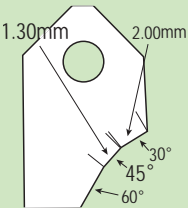

FT-45051V1

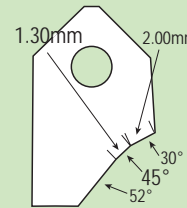

FT-45051V3

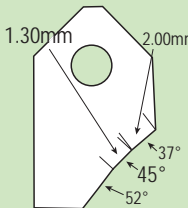

FT-45051X1

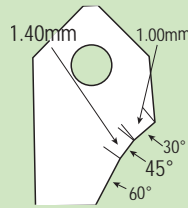

FT-45055V1

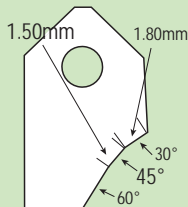

FT-45059V1

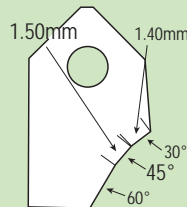

FT-45059V2

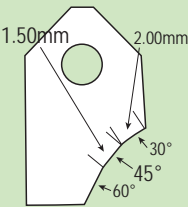

FT-45059V3

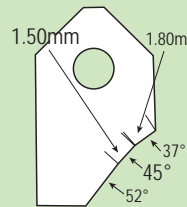

FT-45059X1

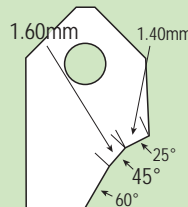

FT-45063U1

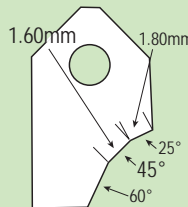

FT-45063U2

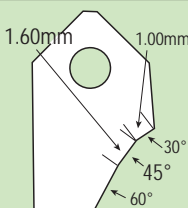

FT-45063V1

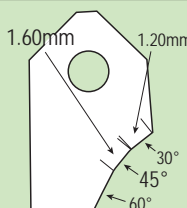

FT-45063V3

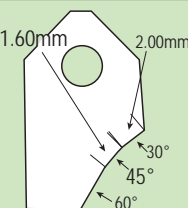

FT-45063V2

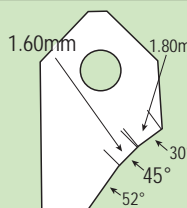

FT-45063W1

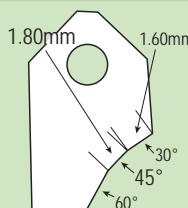

FT-45071V1

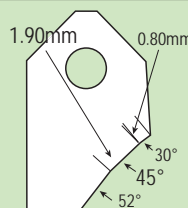

FT-45075V2

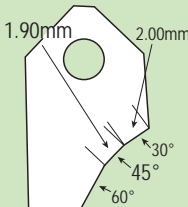

FT-45075V1

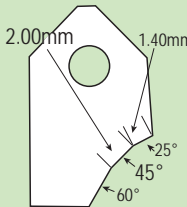

FT-45079U1

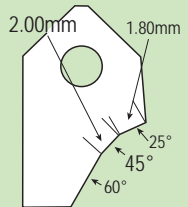

FT-45079U2

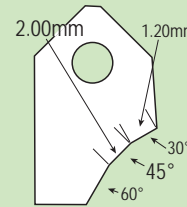

FT-45079V1

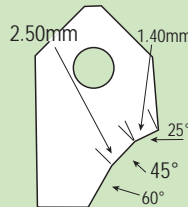

FT-45098U1

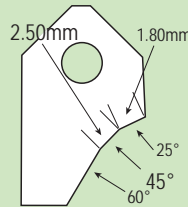

FT-45098U2

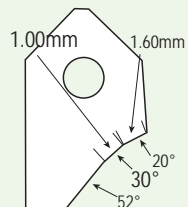

FT-30039T1

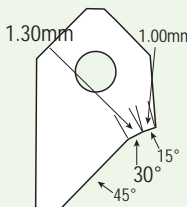

FT-30051S1

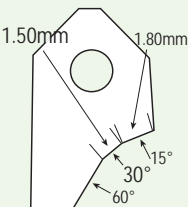

FT-30059S1

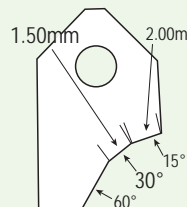

FT-30059S3

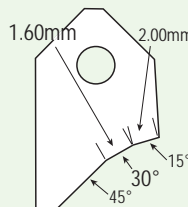

FT-30063S1

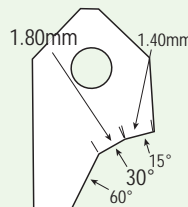

FT-30071S1

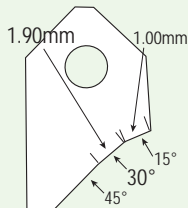

FT-30075S1

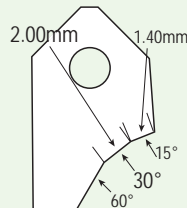

FT-30079S1

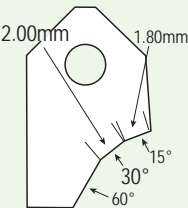

FT-30079S2

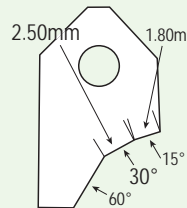

FT-30098S1

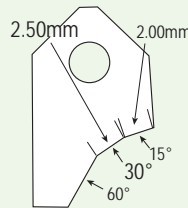

FT-30098S2

resharpening
available
Have Goodson
Resharpen
Your Valve Seat
Cutter Blades
Jobber
\$15.99 ea.

Single Angle Valve Seat Cutter Blades Jobber \$29.99 ea.

CYLINDER HEAD REBUILDING
CLEANING, ASSEMBLY & SAFETY
SHORT BLOCK REBUILDING
CRANKSHAFT/ FLYWHEEL GRINDING
MISCELLANEOUS TOOLS & SUPPLIES
BRAKE SERVICE TOOLING
MEASURING TOOLS
V-TWIN & METRIC HARD PARTS

 FT-15	 FT-20	 FT-25	 FT-30	 FT-35	 FT-37
 FT-39	 FT-45	 FT-50	 FT-52	 FT-55	 FT-60
 FT-65	 FT-70	 FT-75	 FT-82	 FT-90	 FT-R5
 sized for diesel Diesel Blades Jobber \$39.99	 FT-37063S60	 FT-37079S60	 FT-37071S52	 FT-39570T1	 FT-20098S1

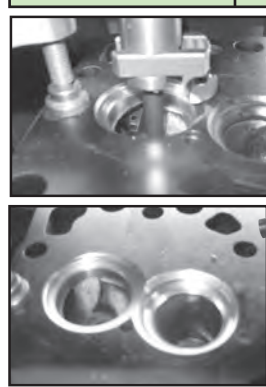

- Increase Low Lift Air Flow
 - Increase Torque
 - Increase Horsepower
- Offset Pilot
Indexing Pin
Mounting Fixture

Diesel Relief Tooling

- Use with your seat and guide machine or Bridgeport Mill equipped with a multi-angle seat cutting system
- Developed for Goodson by Joe Mondello Racing Engines
- Use for 6.0L & 7.3L Ford, 12 Valve, 5.9L Cummins & 6.6L Duramax diesel engines
- For 2-Valve & 4-Valve heads
- Complete kit includes the Mounting Fixture, .375" Top Offset Pilot, Indexing Pin & Radius Cutter
- This tool is only for use with radius cutters BSS-20CC and BSS-45CC

Description	Jobber	Order No.	Incl.
7mm Diesel Relief Tool Kit	\$169.99	DVRT-7MM-KIT	▼
8mm Diesel Relief Tool Kit	169.99	DVRT-8MM-KIT	▼
20CC Radius Cutter for 2-Valve Heads	39.99	BSS-20CC	x
45CC Radius Cutter for 4-Valve Heads	39.99	BSS-45CC	x

 BSS-3001	Intake 7.3L Ford Exhaust	 BSS-3701
 BSS-3002	Intake 6.0L Ford Exhaust	 BSS-3702
 BSS-3001	Intake 12 Valve 5.9L Cummins Exhaust	 BSS-4501
 BSS-4502	Intake 6.6L Duramax Exhaust	 IFT-4524-HD

black smoke series cutters for High Performance Diesel Engines
Developed for Goodson by Joe Mondello Racing Engines. These cutters are designed to be used with your 3-D Fast Cut or other multi-angle tooling. Jobber \$39.99 ea.



See How to Use the Diesel Relief Tooling on YouTube! Search for Diesel Valve Relief Tool.

... another satisfied customer

"It has been a long time since I have seen such a great vendor as these people. They are simply great. I give them an A+++ rating and hope to deal with them more."
 - Wayne Hudson, Hillboro, Oregon (via Facebook), Goodson customer since 2014

CYLINDER HEAD REBUILDING

CLEANING, ASSEMBLY & SAFETY

SHORT BLOCK REBUILDING

CRANKSHAFT/ FLYWHEEL GRINDING

MISCELLANEOUS TOOLS & SUPPLIES

BRAKE SERVICE TOOLING

MEASURING TOOLS

V-TWIN & METRIC HARD PARTS

3-D FAST CUT™ SYSTEM



3-D Fast Cut Adjustable Spring Pad Cutters

- No need to change tooling, just change the tool holder and start cutting spring pads
- Works with all popular 3-angle cutting systems
- Square blades are indexable and replaceable
- Tool holder includes one blade



Tool Holders			
Blade Size	Application	Jobber	Order No.
3/8" / 9.53mm	All except Sunnen®	\$189.99	SPC-375
1/2" / 12.70mm	All except Sunnen®	189.99	SPC-500
Replacement Carbide Cutters (for all holder styles above)			
3/8" / 9.53mm		\$17.99	SPCI-375
1/2" / 12.70mm		17.99	SPCI-500



Minnesota Fast Freeze

- Instantly chills seats & guides to -50°F (-45.5°C) • Creates interference fit with heated aluminum heads • Finish seat and guide work faster than ever • Aerosol*
- Use on tight bushings, pins, shafts, etc.
- Order No. **MFF-8** Jobber \$29.99

*Hazardous Goods Fees Apply When Shipped by Air

Press Fit Lubricants

- A light coat eases press fit
- Ideal for valve guides, piston pins, cylinder sleeves, etc.
- Eliminates the scoring, gouging and galling of parts during press fitting

Description	Jobber	Order No.
Goodson Aerosol® 6 oz. (170 g)	\$12.99	PFL-200*
Sunnen® Aerosol® 7 oz. (198 g)	18.06	B-200*
Sunnen® Brush Applicator 200 mL (not shown)	24.59	B-200L

*Hazardous Goods Fees Apply When Shipped By Air

Buy 12 or more PFL-200 and SAVE 10% off jobber



3-D Fast Cut™ Bowl Profiler

- Machine seats & bowls on a pair of V8 heads in about 40 minutes
- Remove material to recontour cylinder head bowl areas and unshroud valves in combustion chambers
- Blades can be modified using our 3D-SHARP (see page 7)
- Will not work with Sunnen® Ball Heads

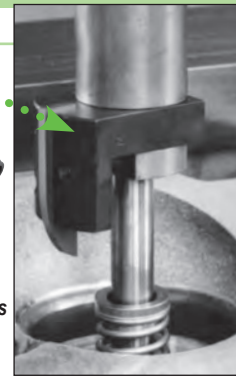

Holder Diameter Range	Jobber	Order No.
1.25"-1.87" / 32-48mm	\$174.99	NBN-1
1.57"-2.13" / 40-54mm	174.99	NBN-2

Blades sold separately

NBN-5	NBN-6	NBN-12	NBN-14	NBN-15
\$79.99	\$79.99	\$114.99	\$114.99	\$114.99

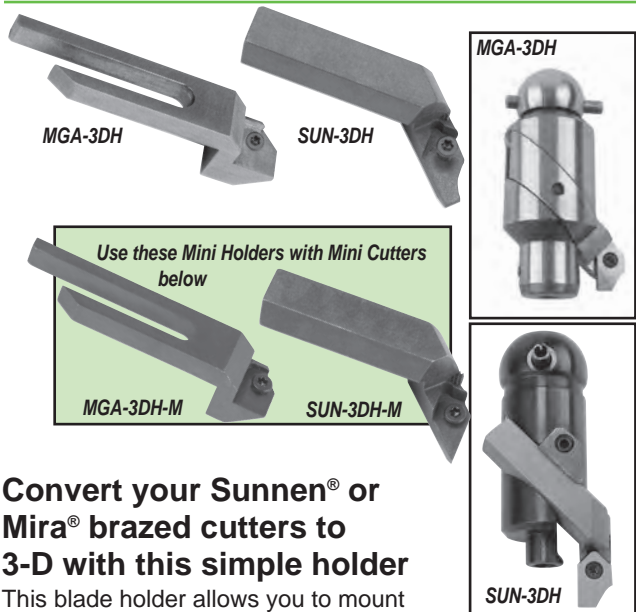

Convert your Sunnen® or Mira® brazed cutters to 3-D with this simple holder

This blade holder allows you to mount premium, replaceable carbide cutters on your existing MIRA® and Sunnen® ball-type tool holders. Choose from our wide selection of replaceable cutters, previously only available for 3-D Fast Cut™ or similar seat cutting systems.

Description	Jobber	Order No.
Standard Cutter	Mira® \$169.99	MGA-3DH
Holders	Sunnen® VSC-Series 174.99	SUN-3DH
Mini Cutter	Mira® 169.99	MGA-3DH-M
Holders	Sunnen® 174.99	SUN-3DH-M
Mini Cutters	30°/45°/60° 39.99	FT-213B-HP
	32°/45°/60° 39.99	FT-215B-HP
view profiles	30°/45°/60° 39.99	FT-4028B-HP
on page 7	45°/90° 39.99	FT-9020B-HP
Replacement Screw	5.99	FT-SCREW

Precision Valve Seat Run-Out Gauge

- Use with .375" Top Pilot
- Measure run-out to .0001" directly from the seat
- Locked to the pilot
- Dial indicator remains stationary while rotating contact pointer
- .800" - 2.500" dia. range
- Order No. **SCG-375**
Jobber \$599.99

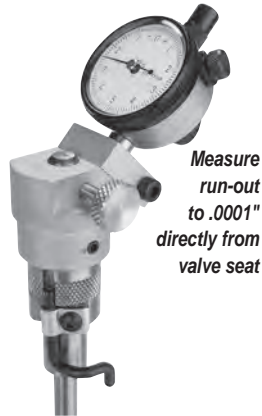

Measure run-out to .0001" directly from valve seat

Valve Seat Run-Out Gauge

- Hardened guide bushings & contact pilot
- Quick thumb screw set-up
- Jeweled bearing indicator reads to ±.050" with .001" precision
- Range: 1.00"-2.50"



Pilot Size	Jobber	Order No.
.375"	\$239.99	VSG-375
.385"	239.99	VSG-385

* Note: Extended length on page NP-7



Valve Seat Machining Aid

- Machine valve seats to a mirror-like finish
- Universal - works with any type of cylinder head machining center
- Use full strength
- Safe for metal surfaces
- Works with mineral-based cutting oils, not water based
- Quart (946mL)
- Order No. **PF-2020**
Jobber \$44.99



Valve and Seat Scribe Tool

- Fits .375" Top Pilot
- Kit includes: tool body, scribe, 1 pilot sleeve, and 6.6mm, 8.0mm, 5/16", 1 1/32" and 3/8" valve stem sleeves • Sleeves fit tool body to valve stems & pilots • Use valve to set point then scribe seat with inner & outer radii • Grind seat top & throat to match face precisely
- Order No. **ST-30-BD** Jobber \$34.99



Layout Fluids

- 2 colors to choose from (blue and red)
- Toluene-free • Dries in minutes
- Provides a thin film without cracking or chipping • Prevents glare with a uniform, deep color
- 2 oz. markers feature felt tip applicator
- 4 oz. containers includes brush in cap



Description	Color	Jobber	Order No.
2 oz. Layout Fluid Markers	Blue	\$10.99	VBF-2
	Red	10.99	VRF-2
4 oz. Layout Fluid	Blue	10.99	VBF-4
	Red	10.99	VRF-4

Cutting & Tapping Fluid

- Cut through even the hardest metals
- Spray clings to the surface of the tool to prolong tool life
- Ideal for stainless steel, high nickel alloys, titanium and more
- Use for reaming, seat cutting and CBN cutting
- Aerosol*
- Order No. **CTF-14*** Jobber \$12.99



*Hazardous Goods Fees Apply When Shipped by Air

Spray Bluing Fluid

- Fast drying • Will not rub off
- Good adhesion to all metals and glass
- Non-corrosive • Resists heat
- No flaking or peeling
- Scribes clean lines for precision work
- Eliminates rags, daubers, spilled bottles
- Dries to a smooth level coating
- Aerosol*
- Order No. **SBF-16*** Jobber \$9.99



*Hazardous Goods Fees Apply When Shipped by Air

Prussian Blue Paste

- Aids precision fitting of machined surfaces
- Locates high spots on bearings, valves, gears and other close-tolerance components
- Non-drying, easy clean-up
- Coat parts with a uniform film of Prussian Blue; assemble in working position and turn shaft; improper fit will show up as easy-to-see bright streaks
- 0.75 fl. oz. tube
- Order No. **PB-75** Jobber \$9.89



CYLINDER HEAD REBUILDING
CLEANING, ASSEMBLY & SAFETY
SHORT BLOCK REBUILDING
CRANKSHAFT/ FLYWHEEL GRINDING
MISCELLANEOUS TOOLS & SUPPLIES
BRAKE SERVICE TOOLING
MEASURING TOOLS
V-TWIN & METRIC HARD PARTS

Neway Valve Seat Cutting System

CYLINDER HEAD
REBUILDING

CLEANING,
ASSEMBLY & SAFETY

SHORT BLOCK
REBUILDING

CRANKSHAFT/
FLYWHEEL GRINDING

MISCELLANEOUS
TOOLS & SUPPLIES

BRAKE SERVICE
TOOLING

MEASURING
TOOLS

V-TWIN & METRIC
HARD PARTS

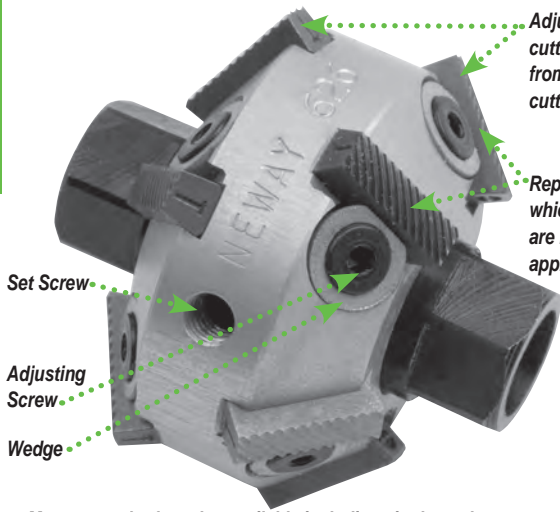

Adjustable Tungsten Carbide cutter blades. Cutters work in a range from 3/8" smaller and 1/4" larger than the cutter body size.

Replaceable cutter blades (see chart for which blades to order for your cutter) are included with body purchase (where applicable).

Cutter body is made of anodized aluminum around a steel hub



Many cutter body styles available including single angle and double angle for a variety of cutting applications

special
order

Don't see the cutter you need in the chart below? Goodson can order any Neway Cutter Body available.

Replacement Blades & Parts

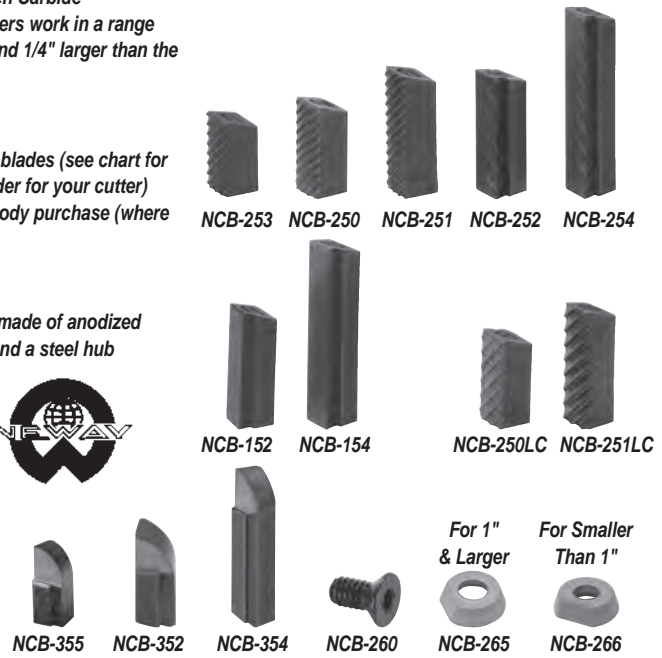

Description	Jobber	Order No.
Small Series Cutter Bodies (Use .297" Top Pilots - page 1)		
Cutter Body	Blade	Qty. Replacement Blade
Diameter	Angle	
0.830" / 21.1mm	32°	3 non-replaceable \$ 94.99 NCU-132
0.850" / 21.6mm	45°	3 non-replaceable 94.99 NCU-131
0.874" / 22.2mm	60°	3 non-replaceable 94.99 NCU-133
0.975" / 24.8mm	31°	3 NCB-250 89.99 NCU-115
	31°	3 NCB-253 89.99 NCU-123
	45°	3 NCB-253 89.99 NCU-122
1.000" / 25.4mm	15°	3 NCB-253 89.99 NCU-120
	30°	3 NCB-250 89.99 NCU-126
	60°	3 NCB-252 89.99 NCU-111
	75°	3 NCB-254 89.99 NCU-125
	31°/46°	3/3 NCB-253 139.99 NCU-103
1.312" / 33.3mm	31°/46°	3/3 NCB-251 142.99 NCU-102
	15°/60°	3/3 NCB-251, -254 142.99 NCU-124
Replacement Blades	Angle	Blade Length
Blades	15-46°	5/16" / 7.9mm \$10.99 NCB-253
Sold Individually		3/8" / 9.53mm 10.99 NCB-250
		1/2" / 12.7mm 10.99 NCB-251
	60-75°	1/2" / 12.7mm 10.99 NCB-252
		3/4" / 19.05mm 10.99 NCB-254
Non-Serrated Correction Blades	60-75°	1/2" / 12.7mm 10.99 NCB-152
Hard Seat Blades	15-46°	3/8" / 9.53mm 10.99 NCB-250LC
		1/2" / 12.7mm 10.99 NCB-251LC
Radius Combustion Chamber Blades		3/8" / 9.53mm 19.99 NCB-355
		1/2" / 12.7mm 19.99 NCB-352
		3/4" / 19.05mm 19.99 NCB-354
Flat Head Screw		1.99 NCB-260
Wedge for bodies 1" / 25.4mm and over		1.99 NCB-265
Wedge for bodies smaller than 1" / 25.4mm		1.99 NCB-266
Tool Kit (includes brush, 2 hex keys and pilot puller)		6.79 NKA-246
Large Storage Case (holds 11 pieces)		28.99 NCA-497
EZ-Turn Wrench		74.99 NTW-EZ
1/2" T-Handle Driver		12.79 NTW-505
3/8" T-Handle Driver		12.79 NTW-513
Drive Adaptor	1/2" to 3/8" / 12.7-9.53mm	12.79 NTW-503-1

Description	Jobber	Order No.
Standard Series Cutter Bodies (Use .375" Top Pilots - page 1)		
Cutter Body	Blade	Qty. Replacement Blade
Diameter	Angle	
1.125" / 28.6mm	30°	3 NCB-250 \$ 84.99 NCU-278
	45°	3 NCB-250 84.99 NCU-268
	60°	3 NCB-252 84.99 NCU-269
1.250" / 31.6mm	15°/75°	3/3 NCB-250, -254 139.99 NCU-212
	30°	3 NCB-250 124.99 NCU-607
1.375" / 35.0mm	30°/45°	3/3 NCB-250 139.99 NCU-230
	31°/46°	3/3 NCB-250 139.99 NCU-203
	45°	5 NCB-250 124.99 NCU-608
	60°	3 NCB-252 84.99 NCU-270
	15°/60°	5/5 NCB-251, -254 232.99 NCU-619
1.500" / 38.0mm	30°/45°	3/3 NCB-250, -251 139.99 NCU-232
	15°/75°	3/3 NCB-251, -254 144.99 NCU-217
1.750" / 44.5mm	30°/45°	3/3 NCB-251 142.99 NCU-234
	30°/45°	5/5 NCB-251 232.99 NCU-626
	31°/46°	5/5 NCB-251 232.99 NCU-622H
	60°	3 NCB-254 84.99 NCU-205
	15°/60°	5/5 NCB-251, -254 232.99 NCU-643
2.000" / 50.8mm	30°/45°	5/5 NCB-251 232.99 NCU-645
	31°/46°	5/5 NCB-251 232.99 NCU-642H
	55°	5 NCB-251 207.99 NCU-17555
	60°	3 NCB-254 84.99 NCU-293
	75°	3 NCB-254 84.99 NCU-272
2.25" / 57.0mm	31°/46°	5/5 NCB-251 232.99 NCU-652
	15°/60°	5/5 NCB-251, -254 232.99 NCU-653
	30°/45°	5/5 NCB-251 232.99 NCU-660
	50°	5 NCB-251 209.99 NCU-20050
	60°	5 NCB-254 124.99 NCU-657
2.50" / 63.5mm	55°	5 NCB-251 209.99 NCU-22555
	15°/60°	5/5 NCB-251, -254 232.99 NCU-666
	30°/45°	7/7 NCB-251 299.99 NCU-677
	50°	7 NCB-251 239.99 NCU-25050
	52°	7 NCB-251 242.99 NCU-25052
	55°	7 NCB-251 239.99 NCU-25055
	60°	5 NCB-251 129.99 NCU-675
	70°	7 NCB-254 232.99 NCU-7063



Neway T-Handle Drivers

- Two sizes to fit small series cutter bodies and standard series cutter bodies
- Adaptor available



Description	Jobber	Order No.
3/8" Hex	\$12.79	NTW-513
1/2" Hex	12.79	NTW-505
1/2" to 3/8" Adaptor	12.79	NTW-503-1

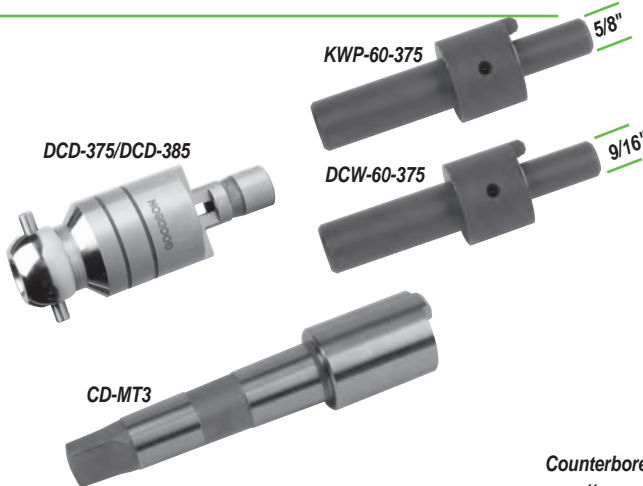

Counterbore Cutter Drive Adaptors

Counterbore cutters on page 14

Cutter Drivers	Jobber	Order No.
#3 MT Driver	\$359.99	CD-MT3
Fits .750" Bridgeport Collet		
3/8" arbor, .375" pilot	\$144.99	DCW-60-375
3/8" arbor, .385" pilot	144.99	DCW-60-385
5/8" arbor, .375" pilot	119.99	KWP-60-375
5/8" arbor, .385" pilot	119.99	KWP-60-385
Ball Head Driver .375" pilot, 3/8" arbor	199.99	DCD-375*
Ball Head Driver .385" pilot, 3/8" arbor	199.99	DCD-385*
Replacement Cutting Insert for DWA Cutter Assemblies	39.99	DKB-7
Replacement Set Screw for DWA Cutter Assemblies	13.99	DKS-7

*Limited to stock on hand

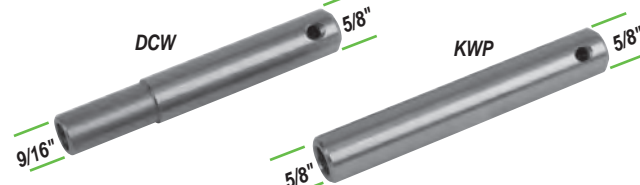

Wear Sleeves for Counter Bore Cutters

- Wear sleeves fit CD-MT3 Driver above

Wear Sleeves			Wear Sleeves		
For 3/8" (14.27mm) arbor DCW & DWI style seat cutters			For 5/8" / 15.87mm arbor KWP & KPI style seat cutters		
Pilot Top Size	Jobber	Order No.	Pilot Top Size	Jobber	Order No.
.375" (9.53mm)	\$78.99	DCW-375	.375" (9.53mm)	\$74.99	KWP-375
.385" (9.78mm)	78.99	DCW-385	.385" (9.78mm)	74.99	KWP-385
.437" (11.10mm)	59.99	DCW-437*	.437" (11.10mm)	59.99	KWP-437*

*Limited to stock on hand

*Limited to stock on hand

Neway Easy Turn Wrench

- Turn cutters continuously
- Produces a smooth seat quickly and easily
- Improves material removal control • Spring loaded
- Includes drive adaptor to convert 1/2" to 3/8"

Description	Jobber	Order No.
Wrench	\$74.99	NTW-EZ
Drive Adaptor	12.79	NTW-503-1

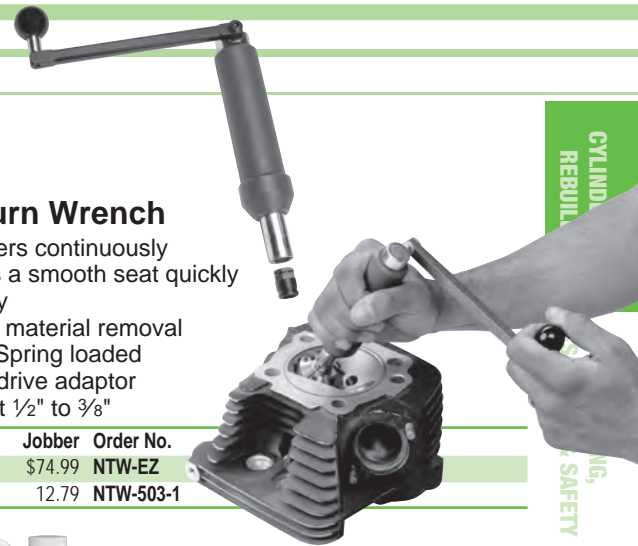

Valve Seat Cutting Fluid

- High silicone content reduces drag on cutters so they last longer
- Promotes smoother cuts
- May be diluted up to 9:1
- Non-aerosol spray

Size	Jobber	Order No.
16 oz. Spray / 473 mL	\$14.99	SCF-2
1 Gal. / 3.79 L	31.99	SCF-10

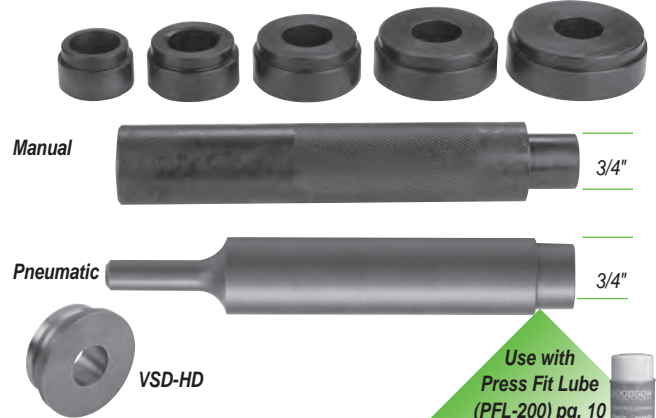

Valve Seat Drivers For Fast Seat Installation

- Pneumatic Drivers install seats faster, easier and without galling • Driver Head ID is .75" / 19.05mm

Description	Jobber	Order No.
Manual Drivers		
.375" / 9.53mm and .385" / 9.78mm ID	\$32.99	VSD-202-G
Driver Heads		
1.000" thru 1.125" Seats / 25.4 - 28.6mm	\$41.99	VSD-203-G
1.250" thru 1.375" Seats / 31.8 - 34.9mm	41.99	VSD-204-G
1.500" thru 1.625" Seats / 38.1 - 41.3mm	41.99	VSD-205-G
1.750" thru 1.875" Seats / 44.5 - 47.6mm	41.99	VSD-206-G
2.000" thru 2.125" Seats / 50.8 - 54.0mm	41.99	VSD-207-G
1.750" thru 2.000" Seats / 44.5 - 50.8mm	29.99	VSD-HD
Pneumatic Drivers		
.375" / 9.53mm and .385" / 9.78mm ID	\$29.99	PSD-385
.437" / 11.10mm ID	29.99	PSD-437

Use with Press Fit Lube (PFL-200) pg. 10 or Fluid Weld (FW-2) pg. 52

CYLINDER REBUILDING
CRANKSHAFT/ FLYWHEEL GRINDING
MISCELLANEOUS TOOLS & SUPPLIES
BRAKE SERVICE TOOLING
MEASURING TOOLS
V-TWIN & METRIC HARD PARTS

... another satisfied customer

"We have been doing business with Goodson for over 10 years. They have outstanding customer service and a great selection of specialty tooling and parts for Harleys."

- Bob LaGuardia, Diamond Bar Choppers, Diamond Bar CA, Goodson customer since 2000

GOODSON Cutters CUT TRUE TO SIZE!

Other cutters may cut as much as .005" smaller



Indexable Counterbore Cutters

These indexable counterbore cutters eliminate down time from having brazed cutters reset or sharpened. You can service them right in your own shop! Each cutter body includes 2 carbide cutter tips with 4 cutting edges. When one edge wears, simply rotate the tip to a new cutting edge. You'll also get insert screws and a wrench with every cutter body.



DWI-SERIES

- Fits DCM Tech, Sunnen, and Winona Van Norman
- 5/16" / 14.3mm arbor



KPI-SERIES

- Fits Kansas Instruments, Kwik-Way and Peterson
- 5/8" / 15.9mm arbor

		DWI-Series DCM Tech, WVN (5/16" arbor)		KPI-Series K.I., KW, Peterson (5/8" arbor)	
Size	mm	Jobber	Order No.	Jobber	Order No.
1.062"	26.97	\$229.99	DWI-1062	-----	-----
1.125"	28.57	229.99	DWI-1125	-----	-----
1.187"	30.15	229.99	DWI-1187	-----	-----
1.250"	31.75	229.99	DWI-1250	\$229.99	KPI-1250
1.312"	33.32	229.99	DWI-1312	229.99	KPI-1312
1.375"	34.93	229.99	DWI-1375	229.99	KPI-1375
1.437"	36.50	229.99	DWI-1437	229.99	KPI-1437
1/4" Replacement Cutting Insert for Cutters above			29.99	29.99	SCI-250-B
Replacement Screw for SCI-250-B				5.99	SCS-T7
Allen Wrench for SCS-T7				8.99	SCW-T7

		DWI-Series DCM Tech, WVN (5/16" arbor)		KPI-Series K.I., KW, Peterson (5/8" arbor)	
Size	mm	Jobber	Order No.	Jobber	Order No.
1.500"	38.10	\$229.99	DWI-1500	\$229.99	KPI-1500
1.562"	39.67	229.99	DWI-1562	229.99	KPI-1562
1.625"	41.28	229.99	DWI-1625	229.99	KPI-1625
1.687"	42.85	229.99	DWI-1687	229.99	KPI-1687
1.750"	42.85	229.99	DWI-1750	229.99	KPI-1750
1.812"	44.45	229.99	DWI-1812	229.99	KPI-1812
1.875"	47.63	229.99	DWI-1875	229.99	KPI-1875
1.937"	49.20	229.99	DWI-1937	229.99	KPI-1937
2.000"	50.80	229.99	DWI-2000	229.99	KPI-2000
2.062"	52.37	229.99	DWI-2062	229.99	KPI-2062
2.125"	53.98	229.99	DWI-2125	229.99	KPI-2125
3/8" Replacement Cutting Insert for Cutters above				45.99	SCI-375-B
Replacement Screw for SCI-375-B				1.99	SCS-T15
Torx Wrench for SCS-T15				5.99	SCW-T15



Minnesota Fast Freeze

- Creates interference fit with heated aluminum heads
- Finish seat and guide work faster than ever
- Aerosol* • Use on tight bushings, pins, shafts, etc.
- Order No. MFF-8 Jobber \$29.99
- * Hazardous Goods Fees Apply When Shipped Air

Nickel-Chrome Valve Seats



WARNING: This product can expose you to chemicals, including Nickel which are known to the state of California to cause cancer

OD	ID	Depth	Order No.	OD	ID	Depth	Order No.
1.250"	0.812"	1/4"	VS-1250	1.625"	1.375"	7/32"	VS-1625A
1.312"	1.000"	1/4"	VS-1312	1.687"	1.375"	1/4"	VS-1687
1.375"	1.062"	1/4"	VS-1375	1.750"	1.500"	1/4"	VS-1750
1.437"	1.125"	1/4"	VS-1437	1.812"	1.500"	1/4"	VS-1812
1.500"	1.187"	1/4"	VS-1500	1.875"	1.562"	1/4"	VS-1875
1.562"	1.250"	1/4"	VS-1562	1.937"	1.625"	1/4"	VS-1937
1.562"	1.312"	7/32"	VS-1562A	2.000"	1.625"	1/4"	VS-2000
1.625"	1.312"	1/4"	VS-1625	Jobber ea.		\$7.99	

Buy 12 or more, save 10% off jobber

Valve Seat Inserts

- For Harley-Davidson®
- Easy to machine
- Effectively dissipate heat for consistent valve sealing
- Hardness increases during engine break-in
- Radiused for easy installation



Replacement Valve Seats For Shovel Head 1200 & 1340

Application	OD	ID	Thickness	MSRP	Jobber	Order No.
Exhaust	1.944"	1.575"	.400"	\$10.12	\$6.99	10-HC493
Intake	2.135"	1.750"	.400"	10.12	6.99	10-HC542

Oversize Seats For Shovel, Evolution & Twin Cam – machining required

OD	ID	Thickness	MSRP	Jobber	Order No.
1.630"	1.180"	.385"	\$10.12	\$6.99	10-HC414
1.757"	1.410"	.430"	10.12	6.99	10-HC447
1.882"	1.530"	.410"	10.12	6.99	10-HC478
2.008"	1.610"	.440"	10.12	6.99	10-HC510
2.040"	1.700"	.425"	10.12	6.99	10-HC518
2.070"	1.610"	.460"	10.12	6.99	10-HC526
2.132"	1.800"	.460"	10.12	6.99	10-HC541
2.163"	1.750"	.455"	10.12	6.99	10-HC549

For Iron Head Sportster

Application	OD	ID	Thickness	MSRP	Jobber	Order No.
Exhaust	1.757"	1.371"	.315"	\$10.12	\$6.99	10-HC446
Intake	2.068"	1.750"	.315"	10.12	6.99	10-HC525

Universal Repair Seat

	OD	ID	Thickness	MSRP	Jobber	Order No.
Powdered	1.339"	1.024"	.375"	\$10.12	\$6.99	10-SC340
Metal	1.693"	1.299"	.434"	10.12	6.99	10-SC430
	1.820"	1.375"	.450"	10.12	6.99	10-HC462
	1.945"	1.375"	.440"	10.12	6.99	10-HC494
	2.257"	1.550"	.500"	10.12	6.99	10-HC573

MSRP = Manufacturer's Suggested Retail Price

See page 5 for valve seat removal tools that fit 3-D Fast Cut

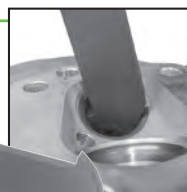

Valve Seat Removers – A Low-Cost Way to Pull Valve Seat Inserts

- Use to pry out valve seat inserts or stubborn grease seals
- Three angles available
- Not recommended for use on aluminum heads
- Set includes one of each angle

Description	Jobber	Order No.
3-Pc. Set	\$129.99	VSP-SET ▼
90°	44.99	VSP-90 x
100°	44.99	VSP-100 x
120°	44.99	VSP-120 x

Valve Lapping Tools & Supplies



Petroleum Based Lapping Compound

- Silicon-carbide, grease-based compound
- Petroleum based valve lapping compound facilitates precise mating between valve seats and valves
- Use with any powered or manual valve lapping tools



Description	Size	Jobber	Order No.
400 Grit	2 oz. / 56.7g	\$11.99	VLC-2-400
600 Grit	2 oz. / 56.7g	11.99	VLC-2-600
800 Grit	2 oz. / 56.7g	12.99	VLC-2-800
1200 Grit	2 oz. / 56.7g	17.99	VLC-2-1200
120 Grit & 280 Grit	2 oz. / 56.7g ea.	28.99	VLC-4
120 Grit	1 lb. / 453.6g	56.99	VLC-120
180 Grit	1 lb. / 453.6g	56.99	VLC-180
280 Grit	1 lb. / 453.6g	56.99	VLC-280

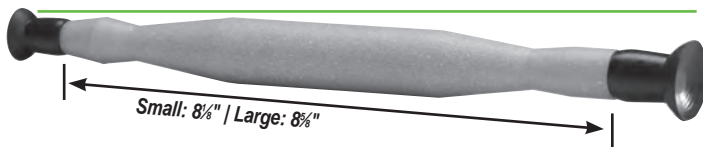

Traditional Valve Lapping Sticks

- Oil resistant polyethylene handles
- Locking tabs eliminate cup slippage

Description	Size	Jobber	Order No.
Small Lapping Stick	8" Long	\$8.99	VLS-15
Replacement Cups	15.9mm / 0.625" dia.	.156"	6.99 VLS-5/8
	20.6mm / 0.813" dia.	.230"	6.99 VLS-13/16
Large Lapping Stick	8" Long	8.99	VLS-30
Replacement Cups	28.6mm / 1.125" dia.	.380"	6.99 VLS-1 1/8
	34.9mm / 1.375" dia.	.380"	6.99 VLS-1 3/8

Conversion Calculator

We've tried to convert as many SAE measurements to Metric (and vice versa) as possible. In some cases there hasn't been enough room.

If you need to convert a measurement, here are the formulas:

Starting Measurement	Conversion Formula	Converted Measurement
Inches (in)	Inches x 25.4	Millimeters (mm)
Feet (ft)	Feet x .3048	Meters (m)
Millimeters (mm)	Millimeters ÷ 25.4	Inches (in)
Fahrenheit (F)	(5÷9) x (F - 32)	Celsius (C)
Celsius (C)	(9÷5) x (C + 32)	Fahrenheit (F)

Iron-Clad Guarantee

Air Powered Valve Lapping Tool



- Operates on 90psi
- Includes air tool and 3 replacement cups • Air actuated ... no electricity needed • Cups also sold separately



Description	Cup ID	Jobber	Order No.
Air Powered Valve Lapping Tool		\$399.99	AVLP-300
Replacement Cups	21mm / 0.827" dia.	.230"	9.99 AVLP-301
	33mm / 1.299" dia.	.380"	9.99 AVLP-302
	38mm / 1.496" dia.	.380"	9.99 AVLP-303

Powered Lapping Tool

- Change rotary action into an effective oscillating motion • Drive with a power drill
- Makes lapping faster and easier
- Includes 2 cup sizes



Description	Cup ID	Jobber	Order No.
Complete Tool		\$175.99	VLP-100
Replacement Cups	22.2mm / 0.875" dia.	.460"	10.99 VLP-10
	25.4mm / 1.000" dia.	.460"	10.99 VLP-20

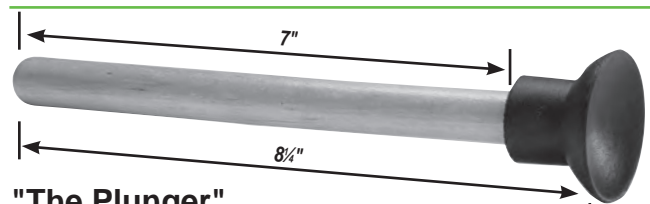

"The Plunger" Hand Valve Lapping Stick

- Large diameter for sure grip
- For 2" and larger valves



Description	Cup ID	Jobber	Order No.
Hand Valve Lapping Stick 8" Long		\$8.99	VLS-75
Replacement Cup 44.5mm / 1.750" dia.	.313"	5.99	VLS-1 3/4

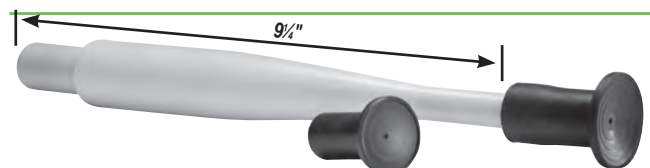

Vacuum Style Lapping Stick

- Press the spring-loaded vacuum pump for a firm hold – stays on until you release the vacuum
- Includes 3 cup sizes (also sold separately)





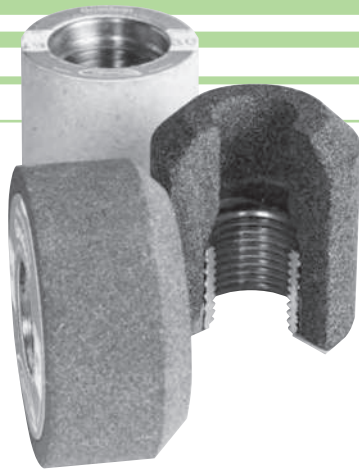

Description	Cup ID	Jobber	Order No.
Vacuum Lapping Stick 9 1/4" Long		\$33.99	VLV-50
Replacement Cups	19.1mm / 0.750" dia.	.415"	8.99 VLV-3/4
	25.4mm / 1.000" dia.	.415"	8.99 VLV-1
	31.8mm / 1.250" dia.	.415"	8.99 VLV-1 1/4

CYLINDER HEAD REBUILDING
CLEANING, ASSEMBLY & SAFETY
SHORT BLOCK REBUILDING
FLYWHEEL GRINDING
CRANKSHAFT/ TOOLS & SUPPLIES
MISCELLANEOUS TOOLS & SUPPLIES
BRAKE SERVICE TOOLING
MEASURING TOOLS
V-TWIN & METRIC HARD PARTS



Goodson seat wheels are built to grind accurately & outlast the competition

- Brass bushings resist galling or seizing to the holder
- Heat-cured, permanent epoxy bonding prevents loose bushings
- Bushings are set deep to expose the most abrasive for long life
- Each wheel is pre-trued and checked to assure accurate, vibration-free grinding

GP 	CB 	S 	F 	NC 	R 
General Purpose Removes material from cast-iron seats or inserts.	Cool Blue Pure Aluminum-Oxide stone. Superior general purpose stone for high performance Beryllium seats. Very sharp.	Stellite Specially formulated to grind Stellite and other types of hardened seat.	Finish Final polishing stone. Gives an ideal final finish with minimal stock removal. Removes chatter marks.	Nickel Chrome For aluminum heads with chrom-alloy seat inserts. Soft abrasive stone to grind hard seats. Speckled.	Ruby The original Black & Decker composition, general purpose stone.

Custom angles and sizes are available in house. Call for more information.

Colors may vary due to manufacturing processes

KW Fits Kwik-Way 13/16"x13 thread

Size			General Purpose (GP) 90 Grit			Cool Blue (CB) 80 Grit		Finishing (F) 150 Grit		Stellite (S) 90 Grit	
Inch	mm	Jobber	00°	30°	45°	00°	45°	30°	45°	00°	45°
1¼"	32	\$13.99	KW-1000-GP	KW-1030-GP	KW-1045-GP	KW-1000-CB	KW-1045-CB	-----	KW-1045-F	KW-1000-S	KW-1045-S
1½"	33	13.99	KW-1000A-GP	-----	KW-1045A-GP	KW-1000A-CB	KW-1045A-CB	-----	-----	-----	-----
1¾"	35	13.99	KW-1100-GP	KW-1130-GP	KW-1145-GP	KW-1100-CB	KW-1145-CB	KW-1130-F	KW-1145-F	KW-1100-S	KW-1145-S
1⅞"	36	13.99	KW-1100A-GP	-----	KW-1145A-GP	KW-1100A-CB	KW-1145A-CB	-----	KW-1145A-F	KW-1100A-S	KW-1145A-S
1½"	38	13.99	KW-1200-GP	KW-1230-GP	KW-1245-GP	KW-1200-CB	KW-1245-CB	KW-1230-F	KW-1245-F	KW-1200-S	KW-1245-S
1⅞"	39	13.99	KW-1200A-GP	-----	KW-1245A-GP	-----	KW-1245A-CB	-----	KW-1245A-F	KW-1200A-S	KW-1245A-S
1¾"	41	13.99	KW-1300-GP	KW-1330-GP	KW-1345-GP	KW-1300-CB	KW-1345-CB	KW-1330-F	KW-1345-F	KW-1300-S	KW-1345-S
1⅞"	43	13.99	KW-1300A-GP	-----	KW-1345A-GP	KW-1300A-CB	KW-1345A-CB	-----	KW-1345A-F	KW-1300A-S	KW-1345A-S
1¾"	44	13.99	KW-1400-GP	KW-1430-GP	KW-1445-GP	KW-1400-CB	KW-1445-CB	KW-1430-F	KW-1445-F	KW-1400-S	KW-1445-S
1⅞"	47	13.99	KW-1500-GP	KW-1530-GP	KW-1545-GP	KW-1500-CB	KW-1545-CB	KW-1530-F	KW-1545-F	KW-1500-S	KW-1545-S
2"	51	13.99	KW-1600-GP	KW-1630-GP	KW-1645-GP	KW-1600-CB	KW-1645-CB	KW-1630-F	KW-1645-F	KW-1600-S	KW-1645-S
2½"	54	13.99	KW-1700-GP	KW-1730-GP	KW-1745-GP	KW-1700-CB	KW-1745-CB	KW-1730-F	KW-1745-F	KW-1700-S	KW-1745-S
2¾"	57	13.99	KW-1800-GP	KW-1830-GP	KW-1845-GP	KW-1800-CB	KW-1845-CB	-----	KW-1845-F	KW-1800-S	KW-1845-S
3½"	60	13.99	KW-1900-GP	KW-1930-GP	KW-1945-GP	KW-1900-CB	KW-1945-CB	-----	-----	-----	-----

Size			Nickel Chrome (NC) 60 Grit		Ruby (R) 80 Grit	
Inch	mm	Jobber	00°	45°	Jobber	00° 45°
1"	25	\$16.99	KW-700-NC	KW-745-NC	\$17.99	KW-700-R KW-745-R
1⅞"	27	16.99	KW-800-NC	KW-845-NC	17.99	KW-800-R KW-845-R
1¾"	28	16.99	KW-900-NC	KW-945-NC	17.99	KW-900-R KW-945-R
1¼"	32	14.99	KW-1000-NC	KW-1045-NC	14.99	KW-1000-R KW-1045-R
1¾"	35	14.99	KW-1100-NC	KW-1145-NC	14.99	KW-1100-R KW-1145-R
1⅞"	36	14.99	KW-1100A-NC	KW-1145A-NC	-----	-----
1½"	38	14.99	KW-1200-NC	KW-1245-NC	14.99	KW-1200-R KW-1245-R
1⅞"	39	14.99	KW-1200A-NC	KW-1245A-NC	-----	-----
1¾"	41	14.99	KW-1300-NC	KW-1345-NC	14.99	KW-1300-R KW-1345-R
1⅞"	43	14.99	KW-1300A-NC	KW-1345A-NC	-----	-----
1¾"	44	14.99	KW-1400-NC	KW-1445-NC	14.99	KW-1400-R KW-1445-R
1⅞"	47	14.99	KW-1500-NC	KW-1545-NC	14.99	KW-1500-R KW-1545-R
2"	51	14.99	KW-1600-NC	KW-1645-NC	15.99	KW-1600-R KW-1645-R
2½"	54	15.99	KW-1700-NC	KW-1745-NC	-----	-----
2¾"	57	15.99	KW-1800-NC	KW-1845-NC	-----	-----
3½"	60	15.99	KW-1900-NC	KW-1945-NC	-----	-----

Ordering is easy!

1 - Find the diameter (valve head diameter from the techxperts™ + 1/16" to 1/8").

2 - Find the angle you need (you can modify angles with our Valve Seat Stone Dresser, page 20).

3- Select the abrasive to match your job.

Save 10% on 10!

Order 10 or more Valve Seat Wheels (any combination, pages 16 and 18) and SAVE 10% off jobber



Hex Drive Seat Grinding Kit
includes everything listed below.
Everything comes packed in
a handy storage case.

Valve Seat Grinding Sets

Order the set as-is or modify a set to meet your specific needs. Set contents include:

Description	OE Number	Jobber	Order No.	Includes		
45° Hex Drive Motor Seat Grinding Set (110V, 50/60 Hz)	—	\$3699.99	SGH-110-KIT	▼		
45° Hex Drive Motor Seat Grinding Set (220V, 50/60Hz)	—	3799.99	SGH-220-KIT	▼		
Flex Drive Motor Seat Grinding Set (110V, 50/60 Hz)	—	3899.99	SGF-110-KIT	▼		
Flex Drive Motor Seat Grinding Set (220V, 50/60Hz)	—	3999.99	SGF-220-KIT	▼		
Hex Drive Seat Grinder - 45° 110V, 50/60Hz	031-3100-20	1299.99	031-3100-20	1		
Hex Drive Seat Grinder - 45° 220V, 50/60Hz	031-3100-27	1399.99	031-3100-27	1		
Flex Drive Seat Grinder 110V, 50/60Hz	031-3000-15	1449.99	031-3000-15	1		
Flex Drive Seat Grinder 220V, 50/60Hz	031-3000-35	1599.99	031-3000-35	1		
Universal Wheel Dresser w/G-13 P Diamond	—	659.99	SWD-UNI	1 1 1 1		
Replacement Dressing Stand Diamond	—	84.99	G-13P			
Dressing Stand Pilot with .437" Top	031-0202-80	149.99	031-0202-80	1 1		
Dressing Stand Pilot with .437" Top	031-1102-89	149.99	031-1102-89	1 1		
Stone Holder - 13/16" x 13 Thread w/Plunger	031-0300-30	379.99	031-0300-30	2 2		
Flex-Drive Stone Holder with Stabilizer	031-0300-64	429.99	031-0300-64	2 2		
Heavy Duty Plastic Case (21 ⁵ / ₁₆ " x 12 ¹ / ₂ " x 13 ¹ / ₂ ")	001-1000-25	51.99	SG-CASE	1 1 1 1		
Seat Stone Removal Tool	—	24.99	KW-SRT	1 1		
Leather Washer / Vibration Reducer (3 Pc.)	031-1009-41	11.99	KHW-3	1 1 1 1		
.437" Top Pilots	Dia./mm					
	.2755" / 7.00mm	030-0237-30	\$59.99 P-5275K	1 1 1 1		
	.2760" / 7.01mm	—	59.99 P-5276K	1 1 1 1		
	.2765" / 7.05mm	030-0237-40	59.99 P-5277K	1 1 1 1		
	.3125" / 7.93mm	030-0239-35	59.99 P-5312K	1 1 1 1		
	.3135" / 7.96mm	030-0239-51	59.99 P-5313K	1 1 1 1		
	.3145" / 7.98mm	030-0239-78	59.99 P-5314K	1 1 1 1		
	.3150" / 8.00mm	030-0239-94	59.99 P-5315K	1 1 1 1		
	.3437" / 8.72mm	030-0242-73	59.99 P-5343K	1 1 1 1		
	.3440" / 8.74mm	030-0243-03	59.99 P-5344K	1 1 1 1		
	.3457" / 8.78mm	030-0243-11	59.99 P-5345K	1 1 1 1		
	.3730" / 9.47mm	030-0247-70	59.99 P-5373K	1 1 1 1		
	.3750" / 9.52mm	030-0247-70	59.99 P-5375K	1 1 1 1		
General Purpose Valve Seat Grinding Stones (1/8" x13)		30°		45°		
1.375" / 35mm	\$13.99	KW-1130-GP	1 1 1 1	\$13.99	KW-1145-GP	1 1 1 1
1.500" / 38mm	13.99	KW-1230-GP	1 1 1 1	13.99	KW-1245-GP	1 1 1 1
1.615" / 41mm	13.99	KW-1330-GP	1 1 1 1	13.99	KW-1345-GP	1 1 1 1
1.750" / 44mm	13.99	KW-1430-GP	1 1 1 1	13.99	KW-1445-GP	1 1 1 1
1.785" / 47mm	13.99	KW-1530-GP	1 1 1 1	13.99	KW-1545-GP	1 1 1 1
2.000" / 51mm	13.99	KW-1630-GP	1 1 1 1	13.99	KW-1645-GP	1 1 1 1
2.125" / 54mm	13.99	KW-1730-GP	1 1 1 1	13.99	KW-1745-GP	1 1 1 1
Finishing Valve Seat Grinding Stones (1/8" x13)		30°		45°		
1.375" / 35mm	\$13.99	KW-1130-F	1 1 1 1	\$13.99	KW-1145-F	1 1 1 1
1.500" / 38mm	13.99	KW-1230-F	1 1 1 1	13.99	KW-1245-F	1 1 1 1
1.625" / 41mm	13.99	KW-1330-F	1 1 1 1	13.99	KW-1345-F	1 1 1 1
1.750" / 44mm	13.99	KW-1430-F	1 1 1 1	13.99	KW-1445-F	1 1 1 1
1.785" / 47mm	13.99	KW-1530-F	1 1 1 1	13.99	KW-1545-F	1 1 1 1
2.000" / 51mm	13.99	KW-1630-F	1 1 1 1	13.99	KW-1645-F	1 1 1 1
2.125" / 54mm	13.99	KW-1730-F	1 1 1 1	13.99	KW-1745-F	1 1 1 1

KWIK-WAY
Seat Grinding Equipment & Supplies
MFG BY
GOODSON
Tools and Supplies for Engine Builders

American Made

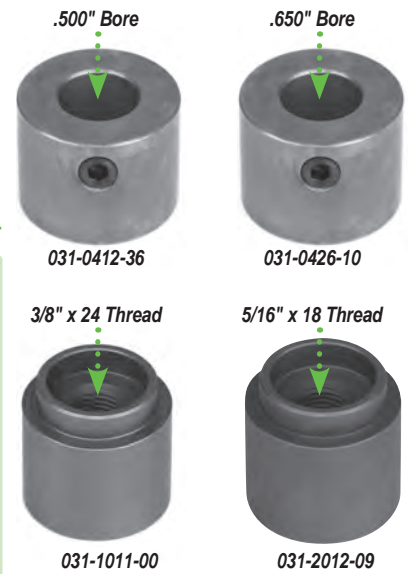

Hex Drive Replacement Assemblies

• Adapt your Seat Grinder Motor to fit various Kwik-Way Seat Grinders

Description	Jobber	Order No.
.500" Bore	\$74.99	031-0412-36
Fit SGA Motor Units with Serial No. 0 to 2000		
.650" Bore	64.99	031-0426-10
Fit SGA Motor Units with Serial No. 4000 & up		
3/8" x 24 Thread	64.99	031-1011-00
Fit SGAll Hex Motor Units		
5/16" x 18" Thread	59.99	031-2012-09
Fit SSG Hex Motor Units		



45° Kwik-Way Hex Drive (SGH) Electric Motor Unit

- Heavy duty electric motor
- 11,500 RPM • Weighs 9 lbs.
- 3/5 HP, 7.5 Amps

Description	Jobber	Order No.
110V, 50/60Hz	\$1299.99	031-3100-20
220V, 50/60Hz	1399.99	031-3100-27
Accessories		
Hex Drive Assembly	74.99	031-3112-17
Leather Washer	4.99	031-1009-41

CYLINDER HEAD
REBUILDING
CLEANING, ASSEMBLY & SAFETY
SHORT BLOCK
REBUILDING
FLYWHEEL GRINDING
CRANKSHAFT/
TOOLING
MISCELLANEOUS
TOOLS & SUPPLIES
BRAKE SERVICE
TOOLING
MEASURING
TOOLS
V-TWIN & METRIC
HARD PARTS



"If you need a custom angle or size in a Valve Seat Stone, Goodson can do it. We grind seat stones in-house to standard and custom dimensions. Give Goodson a call today."

- Tim, Goodson Production - 4 years of service

SX Fits Sioux™, KO Lee, US, Thor, Skil, Winona 11/16"x16 thread

Colors may vary due to manufacturing processes

CYLINDER HEAD
REBUILDING

CLEANING,
ASSEMBLY & SAFETY

SHORT BLOCK
REBUILDING

CRANKSHAFT/
FLYWHEEL GRINDING

MISCELLANEOUS
TOOLS & SUPPLIES

BRAKE SERVICE
TOOLING

MEASURING
TOOLS

V-TWIN & METRIC
HARD PARTS

Size		General Purpose (GP) 70 Grit					Cool Blue (CB) 80 Grit			Ruby 80 Grit			
Inch	mm	Jobber	00°	30°	45°	60°	00°	45°	Jobber	00°	45°		
7/8"	22								\$22.99	SX-500-R	SX-545-R		
15/16"	24								22.99	SX-600-R	SX-645-R		
1"	25								22.99	SX-700-R	SX-745-R		
1 1/16"	27								22.99	SX-800-R	SX-845-R		
1 1/8"	28	\$19.99	SX-900-GP	SX-930-GP	SX-945-GP				22.99	SX-900-R	SX-945-R		
1 3/16"	30	19.99	SX-900A-GP		SX-945A-GP								
1 1/4"	32	13.99	SX-1000-GP	SX-1030-GP	SX-1045-GP	SX-1060-GP	\$13.99	SX-1000-CB	SX-1045-CB	13.99	SX-1000-R	SX-1045-R	
1 5/16"	33	13.99	SX-1000A-GP		SX-1045A-GP		13.99	SX-1000A-CB	SX-1045A-CB				
1 3/8"	35	13.99	SX-1100-GP	SX-1130-GP	SX-1145-GP	SX-1160-GP	13.99	SX-1100-CB	SX-1145-CB	13.99	SX-1100-R	SX-1145-R	
1 1/2"	36	13.99	SX-1100A-GP		SX-1145A-GP		13.99	SX-1100A-CB	SX-1145A-CB				
1 5/8"	38	13.99	SX-1200-GP	SX-1230-GP	SX-1245-GP	SX-1260-GP	13.99	SX-1200-CB	SX-1245-CB	13.99	SX-1200-R	SX-1245-R	
1 7/8"	39	13.99	SX-1200A-GP		SX-1245A-GP		13.99	SX-1200A-CB	SX-1245A-CB				
1 3/4"	41	13.99	SX-1300-GP	SX-1330-GP	SX-1345-GP	SX-1360-GP	13.99	SX-1300-CB	SX-1345-CB	13.99	SX-1300-R	SX-1345-R	
1 11/16"	43	13.99	SX-1300A-GP		SX-1345A-GP		13.99	SX-1300A-CB	SX-1345A-CB				
1 3/2"	44	13.99	SX-1400-GP	SX-1430-GP	SX-1445-GP	SX-1460-GP	13.99	SX-1400-CB	SX-1445-CB	13.99	SX-1400-R	SX-1445-R	
1 7/8"	47	13.99	SX-1500-GP	SX-1530-GP	SX-1545-GP	SX-1560-GP	13.99	SX-1500-CB	SX-1545-CB	13.99	SX-1500-R	SX-1545-R	
2"	51	13.99	SX-1600-GP	SX-1630-GP	SX-1645-GP	SX-1660-GP	13.99	SX-1600-CB	SX-1645-CB	13.99	SX-1600-R	SX-1645-R	
2 1/8"	54	13.99	SX-1700-GP	SX-1730-GP	SX-1745-GP		13.99	SX-1700-CB	SX-1745-CB	13.99	SX-1700-R	SX-1745-R	
2 1/4"	57	13.99	SX-1800-GP	SX-1830-GP	SX-1845-GP	SX-1860-GP	13.99	SX-1800-CB	SX-1845-CB	13.99	SX-1800-R	SX-1845-R	
2 3/8"	60	13.99	SX-1900-GP	SX-1930-GP	SX-1945-GP	SX-1960-GP	13.99	SX-1900-CB	SX-1945-CB	13.99	SX-1900-R	SX-1945-R	
2 1/2"	63	13.99	SX-2000-GP	SX-2030-GP	SX-2045-GP		13.99	SX-2000-CB	SX-2045-CB	13.99	SX-2000-R	SX-2045-R	
2 5/8"	66	13.99	SX-2100-GP	SX-2130-GP	SX-2145-GP		13.99	SX-2100-CB	SX-2145-CB				
Size		Stellite (S) 100 Grit				Finishing (F) 150 Grit				Nickel Chrome 60 Grit			
Inch	mm	Jobber	00°	30°	45°	Jobber	00°	30°	45°	Jobber	00°	30°	45°
1/2"	12.7									\$23.99	SX-200-NC		
9/16"	14.3									23.99	SX-200A-NC		
5/8"	15.9									23.99	SX-300-NC		
1 1/16"	17.4									23.99	SX-300A-NC		
3/4"	19.1									23.99	SX-400-NC		
1 3/16"	20.6									22.99	SX-400A-NC		
1/8"	22					\$23.99	SX-500-F	SX-545-F	22.99	SX-500-NC		SX-545-NC	
1 5/16"	24					23.99	SX-600-F	SX-645-F	22.99	SX-600-NC		SX-645-NC	
1"	25					23.99	SX-700-F	SX-745-F	22.99	SX-700-NC		SX-745-NC	
1 1/16"	27					23.99	SX-800-F	SX-845-F	22.99	SX-800-NC		SX-845-NC	
1 1/8"	28	\$19.99	SX-900-S	SX-930-S	SX-945-S	19.99	SX-900-F	SX-945-F	19.99	SX-900-NC	SX-930-NC	SX-945-NC	
1 3/16"	30	19.99	SX-900A-S		SX-945A-S	19.99	SX-900A-F		SX-945A-F	19.99	SX-900A-NC		SX-945A-NC
1 1/4"	32	12.99	SX-1000-S	SX-1030-S	SX-1045-S	13.99	SX-1000-F	SX-1030-F	SX-1045-F	13.99	SX-1000-NC	SX-1030-NC	SX-1045-NC
1 5/16"	33	12.99	SX-1000A-S		SX-1045A-S	13.99	SX-1000A-F		SX-1045A-F	13.99	SX-1000A-NC		SX-1045A-NC
1 3/8"	35	12.99	SX-1100-S	SX-1130-S	SX-1145-S	13.99	SX-1100-F	SX-1130-F	SX-1145-F	13.99	SX-1100-NC	SX-1130-NC	SX-1145-NC
1 1/2"	36	12.99	SX-1100A-S		SX-1145A-S	13.99	SX-1100A-F		SX-1145A-F	13.99	SX-1100A-NC		SX-1145A-NC
1 5/8"	38	12.99	SX-1200-S	SX-1230-S	SX-1245-S	11.99	SX-1200-F	SX-1230-F	SX-1245-F	13.99	SX-1200-NC	SX-1230-NC	SX-1245-NC
1 7/8"	39	12.99	SX-1200A-S		SX-1245A-S	11.99	SX-1200A-F		SX-1245A-F	13.99	SX-1200A-NC		SX-1245A-NC
1 3/4"	41	12.99	SX-1300-S	SX-1330-S	SX-1345-S	11.99	SX-1300-F	SX-1330-F	SX-1345-F	13.99	SX-1300-NC	SX-1330-NC	SX-1345-NC
1 11/16"	43	12.99	SX-1300A-S		SX-1345A-S	11.99	SX-1300A-F		SX-1345A-F	13.99	SX-1300A-NC		SX-1345A-NC
1 3/2"	44	12.99	SX-1400-S	SX-1430-S	SX-1445-S	11.99	SX-1400-F	SX-1430-F	SX-1445-F	13.99	SX-1400-NC	SX-1430-NC	SX-1445-NC
1 7/8"	47	12.99	SX-1500-S	SX-1530-S	SX-1545-S	11.99	SX-1500-F	SX-1530-F	SX-1545-F	13.99	SX-1500-NC	SX-1530-NC	SX-1545-NC
2"	51	12.99	SX-1600-S	SX-1630-S	SX-1645-S	11.99	SX-1600-F	SX-1630-F	SX-1645-F	13.99	SX-1600-NC	SX-1630-NC	SX-1645-NC
2 1/8"	54	12.99	SX-1700-S	SX-1730-S	SX-1745-S	13.99	SX-1700-F	SX-1730-F	SX-1745-F	13.99	SX-1700-NC	SX-1730-NC	SX-1745-NC
2 1/4"	57	12.99	SX-1800-S	SX-1830-S	SX-1845-S	13.99	SX-1800-F	SX-1830-F	SX-1845-F	13.99	SX-1800-NC	SX-1830-NC	SX-1845-NC
2 3/8"	60	12.99	SX-1900-S	SX-1930-S	SX-1945-S	15.99	SX-1900-F	SX-1930-F	SX-1945-F	13.99	SX-1900-NC	SX-1930-NC	SX-1945-NC
2 1/2"	63	12.99	SX-2000-S	SX-2030-S	SX-2045-S	15.99	SX-2000-F	SX-2030-F	SX-2045-F	13.99	SX-2000-NC	SX-2030-NC	SX-2045-NC
2 5/8"	66									15.99	SX-2100-NC	SX-2130-NC	SX-2145-NC

All Valve Seat Wheels are guaranteed against manufacturing defects for 1 year from original purchase date



2 Angle Valve Seat Wheels

- Use with SX-HOLDER & SX-78 adaptor
- 30° one side, 45° on the other side

Inch		mm		General Purpose	Nickel-Chrome	Cool Blue
Order No.		Order No.		Order No.	Order No.	Order No.
3"	76.2	SXL-2345-GP	SXL-2345-NC	SXL-2345-CB		
3 1/4"	82.5	SXL-2445-GP	SXL-2445-NC	SXL-2445-CB		
3 1/2"	88.9	SXL-2545-GP	SXL-2545-NC	SXL-2545-CB		
3 3/4"	92.3	SXL-2645-GP	SXL-2645-NC	SXL-2645-CB		
4"	101.6	SXL-2745-GP	SXL-2745-NC	SXL-2745-CB		
Jobber		\$24.99	\$24.99	\$24.99		

KWIK-WAY
 Seat Grinding Equipment & Supplies
MFG BY

GOODSON
 Tools and Supplies for Engine Builders



Sioux-Style Valve Seat Grinding Kits

These kits include everything you need to get started in seat grinding. Choose between kits including 110V and 220V Spline Drive Electric Grinders. After that, everything else in the kit is identical. We started with the most common sizes of pilots and valve seat stones, but you can customize one of these kits to meet your specific needs. Call 1-800-533-8010 for additional information.

Description	OE Number	Jobber	Order No.	Includes		
45° Spline Drive Motor Seat Grinding Set (110V, 50/60 Hz)		\$3099.99	SGK-110-KIT	▼		
45° Spline Drive Motor Seat Grinding Set (220V, 50/60Hz)		3199.99	SGK-220-KIT	▼		
Spline Drive Seat Grinder - 45° 110V, 50/60 Hz	031-3100-21	1399.99	031-3100-21	1		
Spline Drive Seat Grinder - 45° 220V, 50/60 Hz	031-3100-28	1499.99	031-3100-28	1		
Universal Seat Wheel Dresser w/G-13P Diamond	-----	659.99	SWD-UNI	1 1		
Replacement Dressing Diamond	-----	84.99	G-13P			
Dressing Stand Pilot	031-0202-55	149.99	031-0202-55	1 1		
Stone Holder - 1/8" x 16 Thread	1702	149.99	SX-HOLDER	2 2		
Heavy Duty Plastic Storage Box (21 ⁵ / ₁₆ " x 12 ¹ / ₂ " x 13 ¹ / ₂ ")	001-1000-25	51.99	SG-CASE	1 1		
Seat Stone Removal Tool	-----	24.99	SX-SRT	1 1		
Bounce Spring Set (3 Pc.)	-----	16.99	BSS-100	1 1		
Leather Washer / Vibration Reducer (3 Pc.)	031-1009-41	11.99	SHW-3	1 1		
.385" Top Pilots	Dia./mm					
	.2755" / 7.00mm	\$49.99	P-5275S	1 1		
	.2763" / 7.02mm	49.99	P-5277S	1 1		
	.2779" / 7.05mm	49.99	P-5278S	1 1		
	.3125" / 7.94mm	49.99	P-5312S	1 1		
	.3130" / 7.95mm	49.99	P-5313S	1 1		
	.3141" / 7.98mm	49.99	P-5314S	1 1		
	.3149" / 8.00mm	49.99	P-5315S	1 1		
	.3430" / 8.71mm	49.99	P-5343S	1 1		
	.3440" / 8.73mm	49.99	P-5344S	1 1		
	.3450" / 8.76mm	49.99	P-5345S	1 1		
	.3750" / 9.53mm	49.99	P-5375S	1 1		
	.3760" / 9.55mm	49.99	P-5376S	1 1		
General Purpose Seat Grinding Stones (1/8"x16)	30°			45°		
1.375" / 35mm	\$13.99	SX-1130-GP	1 1	\$13.99	SX-1145-GP	1 1
1.500" / 38mm	13.99	SX-1230-GP	1 1	13.99	SX-1245-GP	1 1
1.625" / 41mm	13.99	SX-1330-GP	1 1	13.99	SX-1345-GP	1 1
1.750" / 44mm	13.99	SX-1430-GP	1 1	13.99	SX-1445-GP	1 1
1.785" / 47mm	13.99	SX-1530-GP	1 1	13.99	SX-1545-GP	1 1
2.000" / 51mm	13.99	SX-1630-GP	1 1	13.99	SX-1645-GP	1 1
2.125" / 54mm	13.99	SX-1730-GP	1 1	13.99	SX-1745-GP	1 1
Finishing Valve Seat Grinding Stones (1/8"x16)	30°			45°		
1.375" / 35mm	\$13.99	SX-1130-F	1 1	\$13.99	SX-1145-F	1 1
1.500" / 38mm	11.99	SX-1230-F	1 1	11.99	SX-1245-F	1 1
1.625" / 41mm	11.99	SX-1330-F	1 1	11.99	SX-1345-F	1 1
1.750" / 44mm	11.99	SX-1430-F	1 1	11.99	SX-1445-F	1 1
1.785" / 47mm	11.99	SX-1530-F	1 1	11.99	SX-1545-F	1 1
2.000" / 51mm	11.99	SX-1630-F	1 1	11.99	SX-1645-F	1 1
2.125" / 54mm	13.99	SX-1730-F	1 1	13.99	SX-1745-F	1 1



45° Sioux-Style (SGK) Spline Drive Electric Motor Unit

- Heavy duty electric motor
- 11,500 RPM
- Weighs 9 lbs.
- 3/5 HP • 7.5 Amps

Description	Jobber	Order No.
110V, 50/60Hz	\$1399.99	031-3100-21
220V, 50/60Hz	1499.99	031-3100-28



034-3112-00

Replacement Drive Assemblies

- Easy to install
- Always keep one on hand for emergencies

Description	Jobber	Order No.
Spline Drive (SGH)	\$74.99	034-3112-00

CYLINDER HEAD REBUILDING
 CLEANING, ASSEMBLY & SAFETY
 SHORT BLOCK REBUILDING
 FLYWHEEL GRINDING
 CRANKSHAFT/ FLYWHEEL GRINDING
 MISCELLANEOUS TOOLS & SUPPLIES
 BRAKE SERVICE TOOLING
 MEASURING TOOLS
 V-TWIN & METRIC HARD PARTS

Seat Stone Holders, Adaptors & More

CYLINDER HEAD
REBUILDING

CLEANING,
ASSEMBLY & SAFETY

SHORT BLOCK
REBUILDING

CRANKSHAFT/
FLYWHEEL GRINDING

MISCELLANEOUS
TOOLS & SUPPLIES

BRAKE SERVICE
TOOLING

MEASURING
TOOLS

V-TWIN & METRIC
HARD PARTS

Valve Seat Stone Holders & Accessories

- Ball-bearing stone holders • Ideal replacements for worn holders • Save time by having several holders set up with commonly used sizes, compositions or angles of seat stones



031-0300-64 031-0300-80 031-0300-85 031-0300-56 031-0300-30

.437" Pilot, 1 1/16"x13 Thread Kwik-Way Stone Holders		
All Kwik-Way Holders are re-buildable		
	Jobber	Order No.
Flex-Drive Stone Holder with Stabilizer & Coupling	\$414.99	031-0300-64
Flex-Drive Stone Holder with Stabilizer	389.99	031-0300-80
Flex-Drive Stone Holder only	349.99	031-0300-85
Hex-Drive Stone Holder w/o Spring Plunger	349.99	031-0300-56
Hex-Drive Stone Holder with Spring Plunger	389.99	031-0300-30



Accessories		
	Jobber	Order No.
Stabilizer Assembly with Bronze Bushing	\$54.99	031-0126-60
Heavy-Duty Twisted Cable Steel Coupling	82.99	031-0304-10
Replacement Hex Drive Body Cap	72.99	031-0302-95
Replacement Spring Plunger Assembly	9.99	031-0313-97
Leather Vibration Reducer (3 pc.) For KW-Holders	11.99	KHW-3
Valve Seat Stone Removal Tool	24.99	KW-SRT



Rebuild Kits		
	Jobber	Order No.
For Hex Drive Stone Holder without Spring Plunger		
Includes 2 Bearings, Bearing Sleeve, Bearing Lock Nut, Sleeve Key, Hex Cap & Garter Spring	\$189.99	034-0002-00



For Hex Drive Stone Holder with Spring Plunger		
Includes 2 Bearings, Bearing Sleeve, Bearing Lock Nut, Sleeve Key, Hex Cap & Spring Plunger	\$199.99	034-0002-15



For Flex Drive Stone Holder		
Includes 2 Bearings, Bearing Sleeve, Heavy Duty Flex Coupling, Inner Sleeve Key & Set Screw	\$279.99	034-0003-25
Rebuild kit components are not available individually		



.385" Pilot, 1 1/16"x16 Thread Sioux-Style Stone Holders			
	OE #	Jobber	Order No.
Short Body (Spline)	1672	\$139.99	SX-1672
Sioux-Style (Spline)	1702	149.99	SX-HOLDER
5/8" Hex Drive	1702BB	179.99	SX-1702BB

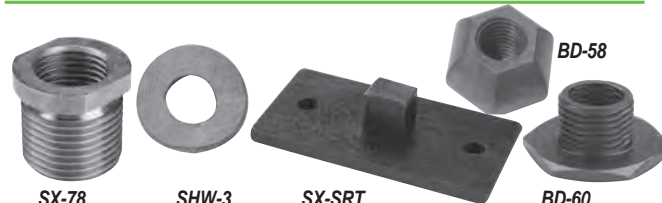

Accessories		
	Jobber	Order No.
Sioux-Style Conversion Bushings 1 1/16"x16 to 7/8"x14	\$ 9.99	SX-78
Leather Vibration Reducer (3 pc.) For SX-Holders	11.99	SHW-3
Standard Bounce Spring Set (3pc.)	16.99	BSS-100
Valve Seat Stone Removal Tool	24.99	SX-SRT

.375" Pilot, Thread Black & Decker Stone Holders				
	OE #	Jobber	Order No.	
Black & Decker Style 5/16"x16	BD-HOLDER	\$199.99	BDS-HOLDER	
Includes BD-60 adaptor to convert 5/16"x16 to 1 1/16"x16 Sioux-style stones				
Sioux-Style fits .375" Pilot 1 1/16"x16 thread		\$199.99	SX-375	
Hex Drive fits .375" Pilot 1 1/16"x13 thread		359.99	KW-375	
Accessories			Jobber	Order No.
Black & Decker 5/8" Hexball 5/8"x24 thread		\$59.99	BD-58	
5/16"-16 to 1 1/16"-16 Adaptor for Sioux Style		9.99	BD-60	



Grinding Wheel Adaptors			
	Description	Jobber	Order No.
1 1/16"-13 (KW) Threaded Stones to 1 1/16"-16 Threaded Holders (Sioux™, KO Lee)		\$61.99	031-0390-02
1 1/16"-13 (KW) Threaded Stones to 5/8"-16 Threaded Holders (Black & Decker)		61.99	031-0391-00
1 1/16"-13 (KW) Threaded Stones to 2 1/32"-18 Threaded Holders (Kwik-Way)		61.99	031-0393-04

Billet Aluminum Tooling Stand		
Accommodates tooling using 3/8" or larger pilots. Perfect for stone holders! Room for up to 5 tools.		
Jobber	Order No.	TS-5

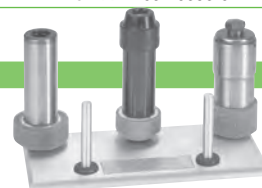

Air & Electric Seat Grinder Motors



Flex Drive (SGF) Heavy Duty Electric Motor Unit

- Heavy duty electric motor
- Flex Drive allows for slight operator misalignment
- 11,500 RPM (free speed) • 6982 RPM (under load)
- Weighs 12 lbs. • 3/5 HP • 7.5 Amps
- Use with Flex Drive Stone Holders (page 20)

Description	Jobber	Order No.
110V, 50/60Hz	\$1449.99	031-3000-15
220V, 50/60Hz	1599.99	031-3000-35
Replacement Nose Assembly	799.99	031-3005-17

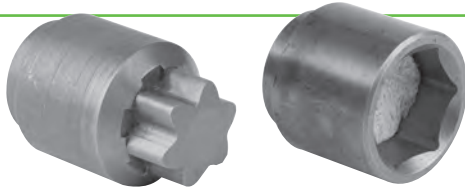

034-3112-00

031-3112-17

Replacement Drive Assemblies

- Easy to install
- Always keep one on hand for emergencies

Description	Jobber	Order No.
Spline Drive (SGK)	\$74.99	034-3112-00
Hex Drive with Leather Washer (SGH)	74.99	031-3112-17
Replacement Leather Washer	4.99	031-1009-41

new

90° Angle High-Speed Air Driver

- 2 models available - spline or hex drive
- 11,000 RPM motor • 5/8" - 11 spindle
- 1/4" air inlet • 6 CFM • Rear exhaust
- Weighs 2.25 lbs. • Measures 8.75" long
- Composite grip and trigger are ergonomically designed for unmatched user comfort

Description	Jobber	Order No.
Spline Drive (SGK)	\$339.99	AG-SX90
Hex Drive (SGH)	339.99	AG-KW90

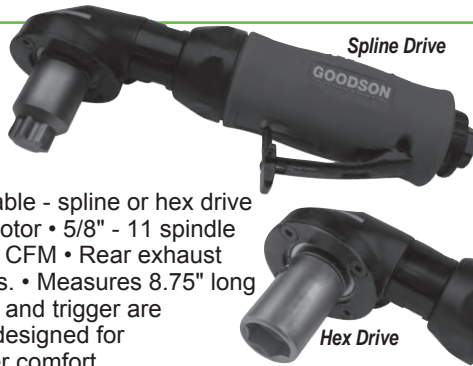

Valve Seat Angle Grinder Adaptors

- Turn your 4 1/2" Angle Grinder with 3/8"x11 threads into a Valve Seat Grinder
- Available for Sioux and Kwik-Way
- Stone holders and pilots available separately

Description	Jobber	Order No.
Spline-Drive (SGK) Adaptor	\$199.99	SW-SX
Hex Socket (SGH) Adaptor	199.99	SW-KW



Kwik-Way 45° Hex Drive (SGH) Electric Motor Unit

- Heavy duty • 11,500 RPM (free speed)
- 6982 RPM (under load) • 9 lbs. • 3/5 HP
- 7.5 amps • Use with Hex Drive Stone Holders (page 20)

Description	Jobber	Order No.
110V, 50/60Hz	\$1299.99	031-3100-20
220V, 50/60Hz	1399.99	031-3100-27
Replacement Nose Assembly	749.99	031-3105-12
Hex Drive Assembly with Leather Washer	74.99	031-3112-17



45° (SGK) Sioux-Style Spline Drive Electric Motor Unit

- Heavy duty • 11,500 RPM (free speed)
- 6982 RPM (under load) • 9 lbs. • 3/5 HP
- 7.5 amps • Use with SX Stone Holder (page 20)

Description	Jobber	Order No.
110V, 50/60Hz	\$1399.99	031-3100-21
220V, 50/60Hz	1499.99	031-3100-28
Replacement Nose Assembly	739.99	034-3105-00
Replacement Spline Drive Assembly	74.99	034-3112-00

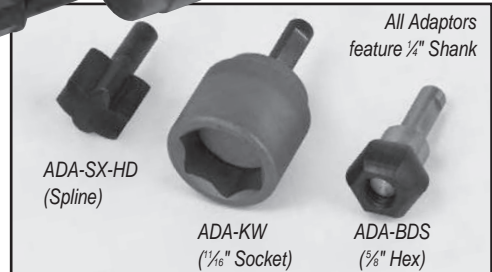

Universal 4500 RPM Air Driver & Adaptors

- Planetary gear set-up reduces speed to 4500 RPM for best finish, more control and increased torque
- Use vertically to reduce side load on stones
- Weighs just 2 lbs./ .91 kg
- Adaptors available for a variety of stone holders
- Precision clamping collet and wrenches included
- Use with bounce springs (page 22) for best results

Description	Jobber	Order No.
4500 RPM Air Driver	\$119.99	AG-4500
Hexball Driver	79.99	ADA-BDS
Kwik-Way Drive Adaptor	79.99	ADA-KW
Sioux-Style Drive Adaptor	89.99	ADA-SX-HD

CYLINDER HEAD
GRINDING
CLEANING,
ASSEMBLY & SAFETY
SHORT BLOCK
CRANKSHAFT/
FLYWHEEL GRINDING
MISCELLANEOUS
TOOLS & SUPPLIES
BRAKE SERVICE
TOOLING
MEASURING
TOOLS
V-TWIN & METRIC
HARD PARTS

Goodson
exclusive**American Made****Universal
Valve Seat Wheel
Dressing Stand**

- Infinitely adjustable from 0° to 90°
- Scale marked in 1° increments
- Dress stones up to 4" diameter
- Includes Premium dresser diamond & dresser pilot
- Base has pre-drilled holes for easy mounting to your bench
- **Choose dresser pilot separately from chart below**

Description	Jobber	Order No.	Incl.
Universal Dressing Stand	\$659.99	SWD-UNI	▼
Replacement Premium Dressing Diamond	84.99	G-13P	x
Dressing Stand Riser Bushings (.250" & .875" Tall)	9.99	SK-9-10	x

Replacement Parts

Spring Detent	\$ 19.99	SWD-UNI-DET
Arm Assembly with Spring & Plunger	239.99	SWD-UNI-ARM

See pages 16-21 for valve seat stones, stone holders, air drivers, etc.

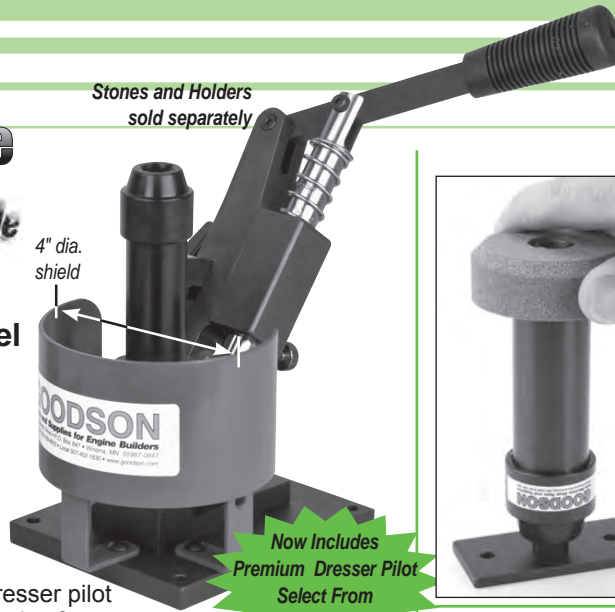
4" dia.
shield**GOODSON**
Supplier for Engine Builders
10000 W. 100th Ave. #200
Lakewood, CO 80027-2047
www.goodson.com**Now Includes
Premium Dresser Pilot
Select From
Chart Below**Stones and Holders
sold separately**Heavy Duty
Valve Seat
Wheel Dresser**

- Ball bearing mounted diamond carrier
- Adjustable in 1° increments from 0° to 90°
- Includes diamond
- **Order dressing pilot separately from list below**
- Designed for maximum accuracy

Description	Jobber	Order No.
Heavy Duty Dresser	\$1229.99	031-1900-02
Replacement Torsion Spring for 031-1900-02	34.99	000-1850-78
Replacement Diamond Dresser	37.99	G-18

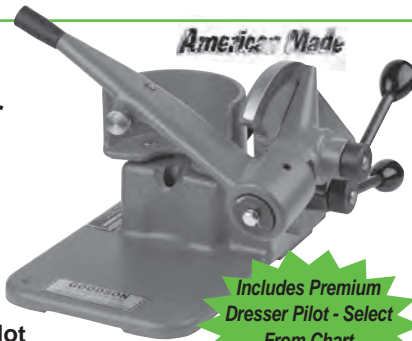
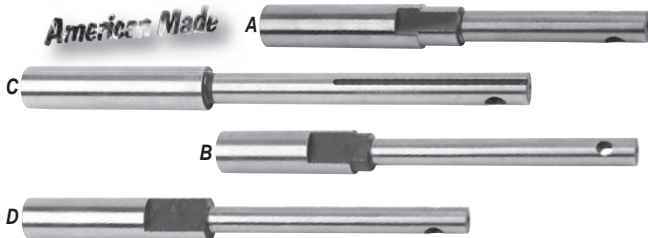
**Includes Premium
Dresser Pilot - Select
From Chart
Below****American Made****Valve Seat Wheel Dresser Pilots for
Universal & Heavy Duty Wheel Dressers**

Dresser Pilots (select based on stone holder type)			
Fits Stone Holder Type	OAL	Jobber	Order No.
A .437" Hex Stone Holder	5 7/8"	\$149.99	031-1102-89
B .437" Hex or Flex Stone Holder	7 7/8"	149.99	031-0202-80
C .385" Top Stone Holder	6"	149.99	031-0202-55
D .375" Top Stone Holder	6 3/8"	149.99	031-0202-47

**Seat Stone Removal Tool**

Once in a while a valve seat stone will be so tight on the stone holder that it's almost impossible to get off. That's why we came up with this tool. Simply fasten it to your bench with screws or bolts (not included) or clamp it in a vise, set the holder onto the fixture and twist the stone off easily.

Description	Jobber	Order No.
Sioux-Style	\$24.99	SX-SRT
Kwik-Way Style	24.99	KW-SRT

Valve Seat Height Gauge

- Adjusts for all popular valve seat diameters • Gauge accurate to .001"
- Seat contact probe aligns on valve seat while gauge rides along the fire deck • Pilot aligns in valve guide
- Fully adjustable seat contact probe and gauge positions allow tool to fit popular seat diameters from .750" to 3.00"
- Includes Dial Indicator



Description	Fits Pilot	Jobber	Order No.
Valve Seat Height Gauge Kit	.375"	\$94.99	VSHG-375
Replacement Dial Indicator		28.99	EDI-1

tech tips

Goodson recommends using Bounce Springs with your Valve Seat Stones to prevent damage to the stone and the seat. This is especially important with the very small stones.

**Standard
Bounce Spring Set**

- Includes 1 each of 3 lengths: 1" / 24.5mm, 1.50" / 38.1mm and 2" / 50.8mm
- ID = .450" / 11.4mm
- OD = .570" / 14.5mm
- Order No. **BSS-100**
Jobber \$16.99

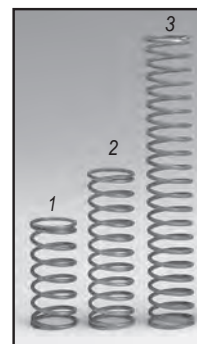
**Small Diameter
Bounce Springs**

- ID = .406" / 10.3mm
- OD = .500" / 12.7mm

Length / mm	Jobber	Order No.
1.10" / 27.9	\$8.99	BS-1
1.67" / 42.4	8.99	BS-2
3.00" / 76.2	8.99	BS-3

Valve Refacing



Use VG-STOP for extra long stemmed valves

Adaptor for 1/2" Chucks

- For small diameter valves • Collet cover range of 2.8 to 6.5mm
- Hardened steel collet holder fits any machine with a 1/2" chuck • Collet seats in retainer nut for fast, easy removal
- Internal stop adjusts with a screwdriver, allowing you to reface an entire set of valves to identical specs quickly
- Start with the set then replace collets as needed (**collets will not work without the holder**) • Use the Adaptor Stop to machine longer valve stems

Description	Range	Jobber	Order No.	Incl.
Full Set		\$299.99	UVRC-46	▼
Steel Collet Holder (collets MUST be used)		205.99	UVRC-46R	x
Replacement	2.8 to 3.2mm (.109" to .125")	38.99	UVRC-18	
Collets	3.0 to 3.5mm (.118" to .138")	38.99	UVRC-3.5MM	
	3.5 to 4.0mm (.138" to .158")	38.99	UVRC-4.0MM	x
	4.0 to 4.5mm (.158" to .177")	38.99	UVRC-4.5MM	
	4.4 to 4.8mm (.172" to .1875")	38.99	UVRC-316	
	4.5 to 5.0mm (.177" to .196")	38.99	UVRC-5MM	x
	4.8 to 5.2mm (.1875" to .203")	38.99	UVRC-1364	
	5.0 to 5.5mm (.196" to .216")	38.99	UVRC-5.5MM	x
	5.5 to 6.0mm (.217" to .236")	38.99	UVRC-6.0MM	x
Adaptor Stop		13.99	VG-STOP	x



Several New Collet Sizes

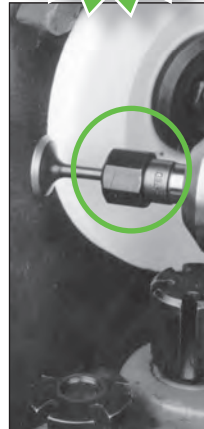

Valve Stem to Valve Face Concentricity Gauge

- Accurate to .001"
- Features a rugged, positive stop – set it once and do an entire set of valves • Use before grinding to eliminate needless cleaning & machine time • Use after refacing to ensure stem concentricity • Also check pilots and other small parts for concentricity
- For stems as small as 4mm
- Order No. **VCG-16** Jobber \$239.99

CYLINDER HEAD REBUILDING
CLEANING, ASSEMBLY & SAFETY
SHORT BLOCK REBUILDING
FLYWHEEL GRINDING
CRANKSHAFT/ MISCELLANEOUS TOOLS & SUPPLIES
BRAKE SERVICE TOOLING
MEASURING TOOLS
V-TWIN & METRIC HARD PARTS

Diamond Dresser Tools for Common Valve Refacers

• Select from Standard or Premium Grade • See the complete assortment of diamond dresser tools on pages 106 and 107.

Machine	Description	Carat	Jobber	Standard	Jobber	Premium
Valve Refacers	B&D, Skil, Sioux™, Thor, VanDorn, WVN	3/8" x 1 1/2"	\$ 37.99	G-1	\$ 74.99	G-1P
	Kwik-Way, Tobin Arp (S&D)	5/16" x 2 1/2"	37.99	G-3	---	---
	Kwik-Way, Valve Master (1714)	1/2" x 3 1/4" 20NF	39.99	G-4	---	---
	Sioux™ (1713, 1715), IDL, WVN (CG50, CG80)	3/8" x 2 3/4" 24NF	39.99	G-5	74.99	G-5P
	IDL, WVN (CG-50, CG-80)	3/8" x 3 1/4" 24NF	44.99	G-80	82.99	G-80P
	US	7/16" x 2"	37.99	G-6	---	---
	Skil (Talent)	5/16" x 2 1/4" 18NC	39.99	G-9	---	---
	Kwik-Way	7/16" x 2 3/4" 20NF	37.99	G-17	74.99	G-17P



GMC-RIMAC



GMC-AG300

new



GMC-KW

Protect Your Valuable Machines When Not In Use!

Sun-Dura® Canvas Machine Covers

- Heavy-weight, breathable black Sun-Dura® fabric won't hold in moisture
- Several sizes to fit a variety of machines • All covers will fit other machines, just match your machine's dimensions to the cover dimensions
- Covers are opaque, pictures for demonstration only

Fits Machine	Dimensions	Jobber	Order No.
Goodson Ring Filer	13"L x 7 1/2"D x 7 1/2"H	\$29.99	GMC-PRF
Rimac Spring Tester	32" Dia. x 18 1/2"H, tapers to 3" sq.	29.99	GMC-RIMAC
Goodson VST-60G Spring Tester	10"L x 14"D x 18"H	39.99	GMC-VST
Sioux 2075 Valve Refacer	35"L x 27"D x 16"H	59.99	GMC-SX
Kwik-Way SVS II Valve Refacer	35"L x 15"D x 12"H, trapezoid shape	59.99	GMC-KW
Sunnen AG-Series Precision Gauge	8"L x 8"W x 4"D	36.99	GMC-AG-300
Rottler VR10 Valve Refacer	45"L x 28"D x 25"H	129.99	GMC-VR10
Rottler VR12 Valve Refacer	39"L x 31"W x 25"D	129.99	GMC-VR12

GMC-PRF



GMC-VST



new



"We pride ourselves on getting orders to you quickly. Goodson stocks a wide variety of products in our warehouse and we use most shipping carriers so you can receive your order in 3 days or less."

- Craig, Goodson Shipping - 4 years of service

Precision made wheels – superior performance

We stock more than 40 individual valve refacer wheels, each one designed for a specific machine. Our 4" general purpose wheel for Black & Decker is different from our 4" general purpose wheel for Sioux™. We won't compromise on performance just to simplify our inventory. Your valve refacer requires a certain type of grit, grade and bond and Goodson delivers. All Goodson Valve Refacing Wheels are designed to be used with mineral based grinding oils such as VGO-10 or VGO-SD10. Goodson guarantees all valve refacing wheels against manufacturing defects for 1 year from original purchase date.

Choose from these types: **ST** = for grinding stainless, **S** = for grinding Stellite, **T** = for grinding Titanium, **GP** = for general purpose grinding and **CB** = for general purpose grinding of harder materials. Stone color may vary due to manufacturing process.

To Fit	Use	Dia x Ht x Arb	Shape	Type	Color	Fits Models	OE No.	Jobber	Order No.
Black & Decker	Valve	4" x 1" x 5/8"	Offset	GP	Gray	A, B, C, LW, M, MW, N, NW, NWB	16371	\$ 39.99	F336037*
		4" x 1" x 5/8"	Offset	CB	Blue	A, B, C, LW, M, MW, N, NW, NWB	Goodson Spec	32.99	GV-146-CB
		4" x 1" x 5/8"	Offset	S	Ruby	A, B, C, LW, M, MW, N, NW, NWB	16371	30.99	GV-144
		4" x 1" x 5/8"	Offset	T	Green	All but 680, 682, 285, 956	Goodson Spec	47.99	GV-150
Comtec	Stem	5" x 1" x 5/8"	Offset/20°	GP	Pink	P, PC, PCB, T, TD, TG	34131	46.99	GV-156
		4" x 1 1/4" x 1/2"	Cup	GP	Ruby	All models	20939	29.99	GV-145
		Valve	215 x 35 x 76mm	Flared	GP	Gray	VR416, RV-516	7604	164.99
IDL Sunnen®	Valve	100 x 50 x 20mm	Cup	GP	White	VR416, RV-516	7606	54.99	GV-928
		8" x 1 1/4" x 1 1/2"	Flared	GP	White	CG-50, -80, -82, V-90, VR-7000	8230	139.99	GV-823
Kwik-Way	Valve	8" x 1 1/4" x 1 1/2"	Flared	GP	Gray	CG-50, -80, -82, V-90, VR-7000	VR1703	184.99	GV-825
		8" x 1 1/4" x 1 1/2"	Flared	S	White	CG-50, -80, -82, V-90, VR-7000	Goodson Spec	121.99	GV-821
		8" x 1 1/4" x 1 1/2"	Flared	T	Green	CG-50, -80, -82, V-90, VR-7000	VR1704	119.99	GV-827
		8" x 1 1/4" x 1 1/2"	Flared	GP	Ruby	CG-80, CG-82, V-90, VR-7000	VR1701	104.99	GV-824
KO Lee	Valve	4 1/2" x 7/8" x 7/8"	Offset	GP	Black	CV, SK, KK, VC, SV, XC	010-0450-10	59.99	GV-257
		4 1/2" x 7/8" x 7/8"	Offset	S	Gray	CV, SK, KK, VC, SV, XC	010-0457-03	41.99	GV-259
		5" x 7/8" x 7/8"	Offset	GP	White	EVS, VS	Goodson Spec	59.99	GV-251
		5" x 7/8" x 7/8"	Offset	GP	Gray	EVS, VS	010-0509-01	59.99	GV-252
		5" x 7/8" x 7/8"	Offset	T	Green	EVS, VS	010-0508-04	124.99	GV-255
		7" x 1" x 7/8"	Offset	GP	Gray	SVS, SVS-2	010-0709-00	61.99	GV-280
		7" x 1" x 7/8"	Offset	CB	Blue	SVS, SVS-2	Goodson Spec	69.99	GV-280-CB
		7" x 1" x 7/8"	Offset	S	White	SVS, SVS-2	010-0707-50	99.99	GV-281
		7" x 1" x 7/8"	Offset	T	Green	SVS, SVS-2	010-0708-05	179.99	GV-282
		7" x 1" x 7/8"	Offset	T	Green	SVS, SVS-2	Goodson Spec	92.99	GV-282A
		7" x 1 9/16" x 7/8"	Offset	GP	Orange	SVS, SVS-2		66.99	F372239*
		7" x 1 9/16" x 7/8"	Offset	GP	Ruby	SVS, SVS-2		69.99	F377419*
Rottler VR-7	Stem	3" x 1 1/4" x 5/8"	Cup	GP	Gray	All Models except VL		39.99	F336036*
		3" x 1 1/4" x 5/8"	Cup	GP	Gray	All but VL	010-0300-05	21.99	GV-237
		3" x 1 1/4" x 5/8"	Cup	CB	Blue	All but VL	Goodson Spec	26.99	GV-237-CB
		8" x 1 3/8" x 7/8"	Offset	GP	Gray	VL	010-0819-04	101.99	GV-260
Rottler VR-8	Valve	5" x 3/4" x 5/8"	Offset	GP	Gray	All models	OV5GH60	87.99	GV-658
		5" x 3/4" x 5/8"	Offset	S	White	All models	OV5GH80S	62.99	GV-659
		4" x 1" x 5/8"	Cup	GP	Gray	K500(C) & K403(C)	RV4KH60	29.99	GV-345
		4" x 1" x 5/8"	Cup	CB	Blue	All but 500 & CRW	Goodson Spec	32.79	GV-345-CB
Rottler VR-9 & VR-12	Valve	7" x 1" x 7/8"	Offset	GP	Gray	VR-7	VTRW-8	61.99	GV-280
		7" x 1" x 7/8"	Offset	T	Green	VR-7	VTRW-7	179.99	GV-282
		7" x 1" x 7/8"	Offset	GP	Orange	VR-7		66.99	F372239*
		7" x 1" x 7/8"	Offset	GP	Ruby	VR-7		69.99	F377419*
Rottler VR-8	Stem	3" x 1 1/4" x 5/8"	Cup	GP	Gray	VR-7	VTRW-9	21.99	GV-237
		3" x 1 1/4" x 5/8"	Cup	GP	Gray	VR-7		39.99	F336036*
Rottler VR-9 & VR-12	Valve	8" x 1 1/4" x 1 1/2"	Flared	GP	Gray	VR-8	Goodson Spec	179.99	GV-525
		100 x 50 x 20mm	Cup	GP	White	VR416, VR-516	7606	54.99	GV-928
Rottler VR-9 & VR-12	Valve	9" x 1 1/4" x 1 1/2"	Offset	GP	Orange	VR-9, VR-12		149.99	GV-725
		9" x 1 1/4" x 1 1/2"	Offset	S	Pink	VR-9, VR-12		139.99	GV-726
Rottler VR-9 & VR-12	Valve	9" x 1 1/4" x 1 1/2"	Offset	T	Green	VR-9, VR-12		139.99	GV-727
		9" x 1 1/4" x 1 1/2"	Offset	T	Green	VR-9, VR-12		139.99	GV-727

Colors may vary due to manufacturing processes. All valve refacing wheels are guaranteed for 1 year from original purchase date.



Note: Look for * to find genuine Radiac valve refacing wheels.



CYLINDER HEAD REBUILDING
CLEANING, ASSEMBLY & SAFETY
SHORT BLOCK REBUILDING
CRANKSHAFT/ FLYWHEEL GRINDING
MISCELLANEOUS TOOLS & SUPPLIES
BRAKE SERVICE TOOLING
MEASURING TOOLS
V-TWIN & METRIC HARD PARTS

Valve Refacing Wheels

Colors may vary due to manufacturing processes. All valve refacing wheels are guaranteed for 1 year from original purchase date.

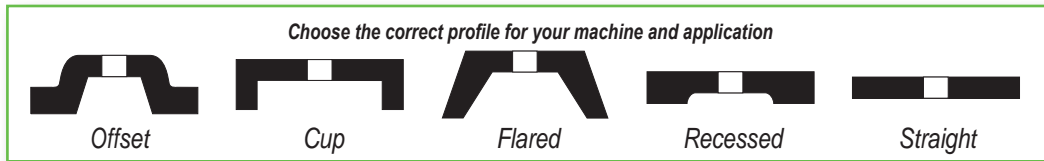

To Fit	Use	Dia x Ht x Arb	Shape	Type	Color	Fits Models	OE No.	Jobber	Order No.
Skil	Valve	5" x 3/4" x 5/8"	Offset	GP	Gray	All models	7556/VW80	\$87.99	GV-658
	Snap-On	Valve	5" x 3/4" x 5/8"	Offset	S	White	All models	VW80S	62.99
		Stem	4" x 1" x 5/8"	Cup	GP	Gray	All but Skil 491	7557/VR2M89	29.99
		Stem	4" x 1" x 5/8"	Cup	CB	Blue	All but 500 & CRW	Goodson Spec	32.79
Sioux™		Valve	4" x 1" x 5/8"	Offset	CB	Blue	All but 680, 682, 285, 956	Goodson Spec	32.99
	4" x 1" x 5/8"		Offset	GP	Gray	All but 680, 682, 285, 956	78SP	33.99	GV-147
	4" x 1" x 5/8"		Offset	GP	Black	All but 680, 682, 285, 956	78E	57.99	GV-148
	4" x 1" x 5/8"		Offset	S	Ruby	All but 680, 682, 285, 956	Goodson Spec	30.99	GV-144
	4" x 1" x 5/8"		Offset	T	Green	All but 680, 682, 285, 956	Goodson Spec	47.99	GV-150
	5" x 1" x 5/8"		Offset/20°	GP	Pink	Thor 299 & 300	Goodson Spec	46.99	GV-156
	7" x 1 1/16" x 1 3/4"		Str./15°	CB	Orange	680, 956, 2001 & 2075	Goodson Spec	54.99	GV-270
	7" x 1 1/16" x 1 3/4"		Str./15°	CB	Blue	680, 956, 2001 & 2075	Goodson Spec	51.99	GV-270-CB
	7" x 1 1/16" x 1 3/4"		Str./15°	S	White	680, 956, 2001 & 2075	177	59.99	GV-271
	7" x 1 1/16" x 1 3/4"		Str./15°	T	Green	680, 956, 2001 & 2075	174	129.99	GV-272
	Stem	7" x .675" x 1 3/4"	Str./15°	GP	Ruby	2001, 2075, 680 & 956		54.99	A379613*
		7" x .675" x 1 3/4"	Str./15°	ST, T	Green	2001, 2075, 680 & 956		49.99	A340229*
Sunnen® (TA) S&D	Valve	6" x 1 1/16" x 3/4"	Flared	GP	Black	VR6500, all S&D	VR602	144.99	GV-766
		6" x 1 3/8" x 3/4"	Flared	GP	Gray	VR6500		129.99	F345291*
	Stem	5" x 1 1/2" x 3/4"	Cup	GP	White	VR6500, all S&D	VR601	79.99	GV-755
Winona	Valve	5" x 3/4" x 5/8"	Off./Bev.	GP	Gray	E, Y, YW, X, XA	75399	87.99	GV-658
		5" x 3/4" x 5/8"	Off./Bev.	S	White	K500HM, K403CM	75400	62.99	GV-659
Norman	Stem	4" x 1" x 5/8"	Cup	GP	Gray	All but 500 & CRW	40352	29.99	GV-345
		4" x 1" x 5/8"	Cup	CB	Blue	All but 500 & CRW	Goodson Spec	32.79	GV-345-CB

Colors may vary due to manufacturing processes. All valve refacing wheels are guaranteed for 1 year from original purchase date.

*Genuine Radiac Valve Refacing Wheels



Mineral Based Valve Grinding Oil

- Long-lasting • Cools while grinding
- Removes particles for a better finish
- Inhibits rust • Prevents rancidity, foaming & deposits

Quantity	Jobber	Order No.
1 gallon / 3.79 L	\$ 29.99	VGO-10
5 gallons / 18.93 L	119.99	VGO-50



Valve Grinding Aid For Titanium, Stainless & Stellite Valves

- Not water soluble - add to your mineral based Valve Grinding Oil for better finish on titanium, stainless steel and stellite valves
- Mix ratio: 1:4 • Won't hinder your regular valve grinding process
- Seeks out, and bonds to hot metals
- Ideal for grinding hard metal racing valves • 32 oz. / 946 mL
- Order No. **VGA-T32** Jobber \$44.99



Severe Duty Valve Refacer Oil For Titanium, Inconel®, Stainless Steel & Stellite Valves

- Mineral Based
- Includes additives to improve cutting performance under high pressure

Size	Jobber	Order No.
1 gallon / 3.79 L	\$ 34.99	VGO-SD10
5 gallons / 18.93 L	159.99	VGO-SD50

CYLINDER HEAD REBUILDING

CLEANING, ASSEMBLY & SAFETY

SHORT BLOCK REBUILDING

CRANKSHAFT/ FLYWHEEL GRINDING

MISCELLANEOUS TOOLS & SUPPLIES

BRAKE SERVICE TOOLING

MEASURING TOOLS

V-TWIN & METRIC HARD PARTS



"At Goodson, we're trained to know your business. Weekly training sessions are held for our entire staff to help us better understand your work so we can provide you with the best possible service."

- Anne, Goodson Accounting - 15 years of service

CYLINDER HEAD
REBUILDING

CLEANING,
ASSEMBLY & SAFETY

SHORT BLOCK
REBUILDING

CRANKSHAFT/
FLYWHEEL GRINDING

MISCELLANEOUS
TOOLS & SUPPLIES

BRAKE SERVICE
TOOLING

MEASURING
TOOLS

V-TWIN & METRIC
HARD PARTS

tech tips

from the techxperts™
For best results,
limit speed to
175 RPM

**High Speed Steel
Core Drill/Reamers**

- Save time – drill and ream in a single pass
- Top-quality, high speed steel
- Prepares the guide bore for standard OD valve guide inserts
- Several shank designs to fit most Seat & Guide machines

Fits	Size	mm	Jobber	Order No.
Peterson and K.I.	.375" x .500"	9.5x12.7	\$199.99	CDR-6197G
½" round shank				
Serdi	.275" x .437"	7.0x11.1	199.99	CDR-7192G
¾" with flat	.275" x .500"	7.0x12.7	199.99	CDR-7193G
	.312" x .437"	7.9x11.1	199.99	CDR-7194G
	.312" x .500"	7.9x12.7	199.99	CDR-7195G
	.343" x .500"	8.7x12.7	199.99	CDR-7196G
	.375" x .500"	9.5x12.7	199.99	CDR-7197G
Cobalt Core Drills/ Reamers				
	.275" x .437"	7.00x11.1	\$199.99	CDR-274-CB
½" round shank	.275" x .500"	7.00x12.7	199.99	CDR-275-CB
	.311" x .5628"	7.90x14.3	199.99	CDR-563-CB
	.312" x .500"	7.92x12.7	199.99	CDR-312-CB
	.343" x .500"	8.71x12.7	199.99	CDR-343-CB
	.373" x .625"	9.47x16.5	199.99	CDR-625-CB
	.375" x .500"	9.53x12.7	199.99	CDR-375-CB

High Speed
Steel Cored Drill/
Reamers are
62 to 64 Rc

Steam-Oxide
Coating for Chip
Lubricity



**Valve Guide Tooling
For 24 Valve,
7mm Cummins**

- To replace integral guides used in this diesel cylinder head
- Replacement guides are .502".511" stepped to use with OE or replacement seals below

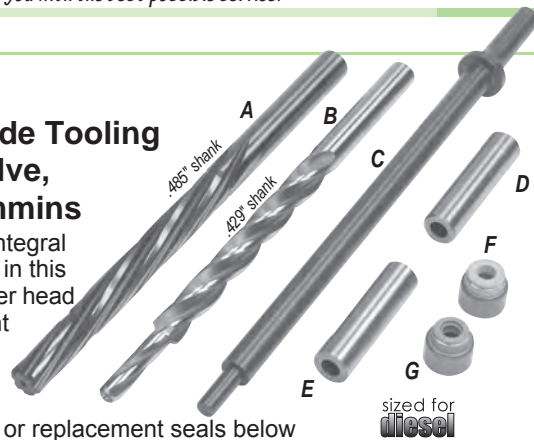

Description	Jobber	Order No.	Includes
Complete Kit	\$399.99	CVG-KIT	▼
Tooling Kit Only	299.99	CVG-59KIT	▼
A Core Reamer (.426" pilot, .485" shank)	159.99	CCR-59	1 1
B Core Drill (7mm pilot, .429" shank)	159.99	CCD-59	1 1
C Guide Driver (7.0mm)	22.99	PHL-2235-G	1 1
D Cast Iron Valve Guide (Exhaust)	3.99	CIG-3022	12
E Cast Iron Valve Guide (Intake)	3.99	CIG-3021	12
F Exhaust Seals (12 pk.)	13.99	CVS-59E	1
G Intake Seals (12 pk.)	13.99	CVS-59i	1

**Check these other tools
for diesel applications**

sized for
diesel

Air Powered Valve Guide Drivers	page 31
Valve Guides	page 32
Pneumatic Valve Spring Compressor.....	page 38
Heat Tabs.....	page 52

Piloted Core Drills and Reamers

- CNC-machined to .0003" T.I.R. or less
- Ideal for any Bridgeport-type (collet driven) machine
- Use dry at 175 to 225 RPM

Piloted Core Drills

- Center accurately in the guide
- Cutting angle prevents the bit from wandering due to irregular guide wear
- Flutes are designed to enlarge bores quickly

Precision Reamers

- Pilot size is carefully matched to the OD of the related core drill
- Assures accurate location of the reamer for smooth, vibration free operation
- Gives proper interference fit to match manufacturer specifications

American Made

High Speed
Steel Core Drill/
Reamers are
65 to 67 Rc

Bronze-Oxide
Coating for
Chip Lubricity

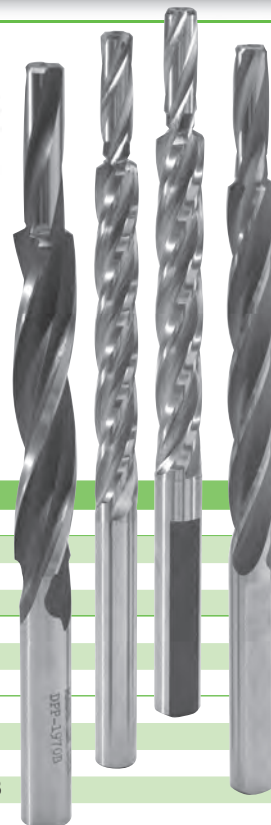

Core Drills					Core Reamers				
	OD	Pilot	OE No.	Jobber	Order No.	OD	OE No.	Jobber	Order No.
DCM Tech,	.4687"	.312"	DP-1550	\$109.99	DPP-1511B	.500"	66-02147, RR-115	\$109.99	DRR-115
Peterson / K.I.	.4687"	.344"	66-02138, DP-1511	109.99	DPP-1511	.500"	66-02147, RR-115	109.99	DRR-115
½" Round	.5937"	.375"	66-02144, DP-1930	109.99	DPP-1970B	.625"	66-02149, RR-519	109.99	DRR-519
Sunnen® /	.490"	.312"	VGS-156A	109.99	DTA-2082B	.500"	VGS-162A	109.99	DRT-2097
Tobin-Arp	.490"	.343"	VGS-152A	109.99	DTA-2082	.500"	VGS-162A	109.99	DRT-2097
½" with Flat	.490"	.371"	VGS-153A	109.99	DTA-2083	.500"	VGS-162A	109.99	DRT-2097
Universal	.429"	7mm	sized for diesel	159.99	CCD-59	.4365"	Use for Ford 6.0L Diesel	133.99	FCR-60-1
.429" Round	.429"	7mm	sized for diesel	159.99	CCD-59	.4375"	Use for Ford 6.0L Diesel	133.99	FCR-60
Shank	.429"	7mm	sized for diesel	159.99	CCD-59	.4995"	Use for Cummins Diesel	159.99	CCR-59
						.562"	.500" pilot	159.99	CCR-562B
	.541"	8mm		159.99	CCD-550	.550"	.540" pilot	159.99	CCR-550

Note: For the best performance, Core Drills and Reamers should be used in matched pairs. If you order a drill slightly smaller or larger than the OE specification to fit your machine, please order the matching reamer listed immediately to the right of the drill in the table.

Bronze Reaming Oil

- Prevents build-up • Extends reamer life • Improves valve guide finish

Size	Jobber	Order No.
1 Pint / 473.2mL	\$ 9.99	BW-303-G
1 Quart / 946.4mL	15.99	BW-303A-G
1 Gallon / 1.893L	35.99	BW-305-G



tech tips From the techxperts™ For best results always use Carbide Reamers with Bronze Reaming Oil (BW-303A-G)

Extended pilot section for easier alignment with the guide

Pilot portion of reamer features 4 flutes to deliver more cutting oil to the work piece

Reamer body features 8 flutes to cut bronze valve guides quickly, accurately and repeatably

Solid Carbide Valve Guide Reamers Specifically Designed For Use Only With Bronze Guides

- Unique 8-flute body design with 4-flute pilot for longer tool life
- New cutting geometry requires less torque to drive the reamer
- More rigid tool construction
- Faster feeds than conventional design
- Pilot allows easier alignment with guide
- Simply the best bronze valve guide reamer we've created!
- Use at 300 to 400 RPM • OAL: 6.00" (nominal)
- Pilot measures approximately .005" smaller than cutting diameter

Inch	mm	Jobber	Order No.	Inch	mm	Jobber	Order No.
.1771"	4.50	\$199.99	HGR-4.5MM*	.3115"	7.91	\$214.99	HGR-3115
.1968"	5.00	199.99	HGR-5.0MM*	.3120"	7.92	214.99	HGR-3120
.2165"	5.50	199.99	HGR-5.5MM*	.3140"	7.98	214.99	HGR-3140
.2362"	6.00	214.99	HGR-6MM	.3160"	8.00	214.99	HGR-8MM
.2750"	6.98	214.99	HGR-2750	.3410"	8.66	214.99	HGR-3410
.2756"	7.00	214.99	HGR-7MM	.3420"	8.69	214.99	HGR-3420
.2766"	7.03	214.99	HGR-2766	.3425"	8.70	214.99	HGR-3425
.3110"	7.90	214.99	HGR-3110	.3430"	8.71	214.99	HGR-3430
Pilot, Flute & Shank Dimensions slightly smaller; call for specific details				.3435"	8.72	214.99	HGR-3435
				.3440"	8.74	214.99	HGR-3440
				.3543"	9.00	214.99	HGR-9MM

tech tips Once used on cast iron, do NOT use on bronze.

Small Reamers for Cast Iron or Bronze

- Premium quality reamers with tough cobalt flutes for long life in cast iron or bronze • 1/8" square drive
- Use at 200 to 300 RPM

Inch	mm	Jobber	Order No.
.1575"	4.00	\$89.99	MR-4MM
.1771"	4.50	89.99	MR-4.5MM
.1968"	5.00	89.99	MR-5.0MM
.1980"	5.03	89.99	MR-198
.2165"	5.50	89.99	MR-5.5MM
.2362"	6.00	89.99	MR-6.0MM
.2756"	7.00	99.99	MR-7.0MM



High Speed Finish Reamers Exclusively for Cast Iron

Precision size cast iron guides. Piloted and made from the finest tempered steel. With proper care, these reamers will accurately size multiple guides without losing their efficient cutting action. **NOT for hardened or bronze guides.** Use at 400 to 500 RPM. Pilot area measures .012" smaller than cutting diameter.

Inch	mm	Jobber	Order No.
3/16" Square Drive			
.2165"	5.50	\$46.99	WR-5.5MM-G
.217"	5.51	46.99	WR-217-G
.218"	5.54	46.99	WR-218-G
.236"	6.00	46.99	WR-6MM-G
.250"	6.35	46.99	WR-250-G
.256"	6.50	46.99	WR-6.5MM-G
.259"	6.58	46.99	WR-259-G
.260"	6.60	46.99	WR-260-G
.273"	6.93	46.99	WR-273-G
.274"	6.96	46.99	WR-274-G
.275"	6.99	46.99	WR-275-G
.2755"	7.00	46.99	WR-7MM-G
.276"	7.01	46.99	WR-276-G
.277"	7.03	46.99	WR-277-G
.278"	7.06	46.99	WR-278-G
.281"	7.14	46.99	WR-281-G

Inch	mm	Jobber	Order No.
1/4" Square Drive			
.310"	7.87	\$46.99	WR-310-G
.311"	7.90	46.99	WR-311-G
.312"	7.92	46.99	WR-312-G
.313"	7.95	46.99	WR-313-G
.314"	7.98	46.99	WR-314-G
.315"	8.00	46.99	WR-8MM-G
.316"	8.03	46.99	WR-316-G
.317"	8.05	46.99	WR-317-G
.341"	8.66	46.99	WR-341-G
.342"	8.69	46.99	WR-342-G
.343"	8.71	46.99	WR-343-G
.3435"	8.72	46.99	WR-3435-G
.344"	8.74	46.99	WR-344-G
.345"	8.76	46.99	WR-345-G
.346"	8.79	46.99	WR-346-G
.354"	9.00	46.99	WR-9MM-G
.355"	9.02	46.99	WR-355-G
.356"	9.04	46.99	WR-356-G
.358"	9.09	46.99	WR-358-G

Inch	mm	Jobber	Order No.
1/4" Square Drive			
.372"	9.45	\$46.99	WR-372-G
.373"	9.47	46.99	WR-373-G
.374"	9.50	46.99	WR-374-G
.375"	9.52	46.99	WR-375-G
.376"	9.55	46.99	WR-376-G
.377"	9.58	46.99	WR-377-G
.378"	9.60	46.99	WR-378-G
.379"	9.63	46.99	WR-379-G
.380"	9.65	46.99	WR-380-G
.386"	9.80	46.99	WR-386-G
.394"	10.00	54.99	WR-10MM-G
.395"	10.03	54.99	WR-395-G
.405"	10.29	54.99	WR-405-G
.433"	11.00	54.99	WR-11MM-G
.436"	11.07	54.99	WR-436-G
.437"	11.10	54.99	WR-437-G
.453"	11.51	54.99	WR-453-G
.472"	12.00	54.99	WR-12MM-G
.499"	12.67	54.99	WR-499-G
.500"	12.70	54.99	WR-500-G

tech tips From the techxperts™

For best results, use high speed steel finish reamers exclusively on cast iron. Ream without oil.

CYLINDER HEAD REBUILDING
CLEANING, ASSEMBLY & SAFETY
SHORT BLOCK REBUILDING
FLYWHEEL GRINDING
CRANKSHAFT/TOOLS & SUPPLIES
MISCELLANEOUS
BRAKE SERVICE TOOLING
MEASURING TOOLS
V-TWIN & METRIC HARD PARTS

... another satisfied customer

"I have been using the Goodson Hyper-Finish Diamond Valve Guide Hone for years. It makes quick and easy work for valve guide sizing. It will not load up, keeps the guide straight and true and gives great results every time. Best money I've spent on a tool."

- Wes Brown, Cycle-Rama, Inc., Pinellas Park, Florida, Goodson customer since 1999

CYLINDER HEAD REBUILDING

CLEANING, ASSEMBLY & SAFETY

SHORT BLOCK REBUILDING

CRANKSHAFT/ FLYWHEEL GRINDING

MISCELLANEOUS TOOLS & SUPPLIES

BRAKE SERVICE TOOLING

MEASURING TOOLS

V-TWIN & METRIC HARD PARTS



Introduced to the World Market in 2010!

Hyper-Finish Diamond Sizing System has the largest range of any guide hone on the market today

Goodson's exclusive Hyper-Finish Diamond Valve Guide Sizing System is bigger and better than ever. With this easy-to-use system you can size guides from .154" to .566" (3.9 -14.40mm) just by switching out mandrels. Mandrels also sold individually. The Drive Head (HF-100) fits every size mandrel assembly shown in the chart below and features a Quick Change set-up. Hyper-Finish Tooling is NOT interchangeable with Sunnen® (p. 30).

Size	Range		Mandrel Assembly (abrasive & mandrel)	Abrasive Length	Abrasive Only	Mandrel Only	Drive Head	Guide Brush	
	inch	mm							
4.0mm	.154"-.164"	3.90 - 4.15mm	\$329.99 HFM-154C	20mm	HFS-154	HFM-154	HF-100	GVP-8N	
4.5mm	.173"-.183"	4.40 - 4.90mm	329.99 HFM-173C	40mm	HFS-173	HFM-173	HF-100	GVP-9N	
5.0mm	.193"-.203"	4.90 - 5.15mm	329.99 HFM-193C	40mm	HFS-193	HFM-193	HF-100	GVP-9N	
5.5mm	.212"-.232"	5.40 - 5.90mm	329.99 HFM-212C	40mm	HFS-212	HFM-212	HF-100	GVP-10N	
6.0mm	.232"-.253"	5.90 - 6.40mm	329.99 HFM-232C	40mm	HFS-232	HFM-232	HF-100	GVP-10N	
6.5mm	.251"-.271"	6.40 - 6.90mm	329.99 HFM-251C	40mm	HFS-251	HFM-251	HF-100	GVP-11N	
7.0mm	.271"-.311"	6.90 - 7.90mm	399.99 HFM-271C	80mm	HFS-271	HFM-271	HF-100	GVP-11N	
.312"	.307"-.347"	7.80 - 8.80mm	399.99 HFM-307C	80mm	HFS-307	HFM-307	HF-100	GVP-1N	Included in Master Kit
.343"	.334"-.374"	8.50 - 9.50mm	399.99 HFM-344C	80mm	HFS-344	HFM-344	HF-100	GVP-2N	
.375"	.350"-.389"	8.90 - 9.90mm	399.99 HFM-350C	80mm	HFS-350	HFM-350	HF-100	GVP-3N	
10.0mm	.389"-.429"	9.90 - 10.90mm	399.99 HFM-394C	80mm	HFS-394	HFM-394	HF-100	GVP-4N	
11.0mm	.429"-.507"	10.90 - 12.90mm	399.99 HFM-429C	80mm	HFS-429	HFM-429	HF-100	GVP-5N	
12.5mm	.488"-.566"	12.40 - 14.40mm	649.99 HFM-488C	80mm	-----	-----	HF-100	GVP-6N	
				Jobber	\$154.99	\$279.99	\$354.99	\$6.99	



Diamond Abrasive produces 25 RA finish in soft guides and 8-10 RA in hardened guides. Every mandrel-abrasive assembly is quality checked to ensure it is true and on size.

Included in Master Kit

Goodson
exclusive



Diamond Honing Oil

For high pressure honing

Size	Jobber	Order No.
8 oz./237mL	\$ 5.29	DHO-8
1 Gallon/3.79L	38.99	DHO-10
5 Gallons/18.93L	174.99	DHO-50

Choose from the Standard Master Kit or Build Your Own!

Standard Master Kit includes: Driver Head, 4-Mandrel Assemblies (see chart above), 4-Nylon Valve Guide Brushes (7mm to 3/8") and 8 oz. Diamond Honing Oil. Order No. HF-KIT Jobber \$1529.99

Custom Kit includes: Driver Head, 4-Mandrel Assemblies (select from chart above, **excluding 12.5mm**), 4-Nylon Valve Guide Brushes (you pick the sizes - see chart above) and 8 oz. Diamond Honing Oil. Order No. HF-KIT-CUSTOM Jobber \$1529.99



American Made

Adjustable hose lets you direct coolant right where you need it

Perforated steel grate lets oil through and can be removed for cleaning

Rolled front edge directs splashed coolant back into the sump

Adjustable hose lets you direct coolant right where you need it

1/2" diameter holes (18) and 1" diameter holes (2) drilled in the top plate provide ample tool storage

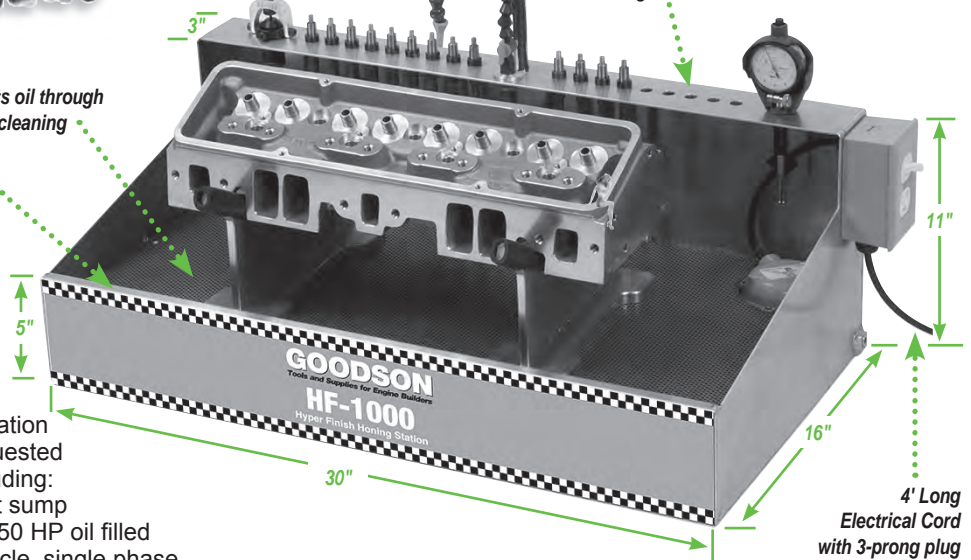

Hyper-Finish Guide Honing Station

This Goodson designed honing station incorporates the features you requested in a bench top honing station including:

- Large 5-gallon capacity coolant sump
- Integral high output pump - 1/150 HP oil filled submersible pump, 115V 60 cycle, single phase heavy-duty motor
- Aluminum construction for durability and easy cleaning
- Perforated steel grate allows used coolant through to recirculate
- Removable steel grate for easy maintenance
- Built-in, easy-to-reach storage for tools

- Buy the complete kit and save!

Description	Jobber	Order No.	Incl.
Complete 110V Honing Station Kit	\$1099.99	HF-1000KIT	▼
Honing Station Only - 110V	869.99	HF-1000	x
Universal Head Holders	139.99	HH-200	x
Replacement Pump 110V	144.99	HF-PUMP	x
5 Gallons Diamond Honing Oil	174.99	DHO-50	x

Export voltage available, contact Goodson for additional information

Carbide or High Speed Steel Valve Guide Top Cutters

• Matches Seat & Guide machine pilots

Description	Shank	Jobber	Order No.
Cutters			
1 1/4" High-Speed Steel	.500"	\$ 59.99	G FH-100
1 1/4" Carbide	.500"	154.99	G FC-200
1 1/8" High-Speed Steel	.486"	109.99	G FH-300
Shank Pilots			
3/16" (.1875")	.312" (7.93mm)	15.99	G FP-312
	.343" (8.73mm)	15.99	G FP-343
	.375" (9.53mm)	15.99	G FP-375
	.437" (11.11mm)	15.99	G FP-437
	.500" (12.70mm)	15.99	G FP-500

3/16" diameter shank

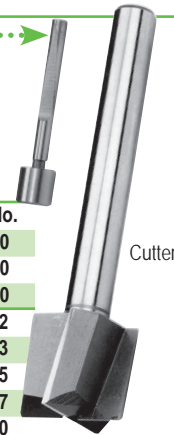

Cutter



Valve Guide OD Chamfer Tool

- Improve oil deflection
- Universal cutter chamfers any OD from 1/4" to 5/8" (6.35-15.9mm)
- Most precise when used in a Seat and Guide Machine
- Order No. **GCT-35**
Jobber \$79.99



1" Diameter Carbide Top Cutter / Spot Facer

- Long-life, quick-cutting carbide blades
- Shorten or face cast-iron valve guides and stud bosses up to 1" / 25.4mm diameter
- Universal drive shank fits all types of power chucks 3/8" or larger

Description	Jobber	Order No.
Cutter Body	\$129.99	G-1270
Pilot		
.312" (7.93mm)	19.99	G-1270A
.343" (8.73mm)	19.99	G-1270B
.375" (9.53mm)	19.99	G-1270C

Pilot Installs Here

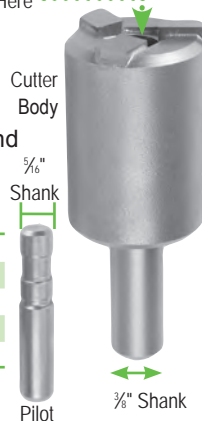

Cutter Body

3/8" Shank

Pilot

3/8" Shank



Valve Guide Top Collar

- Supports guide top during machining
- Protects against damage or breakage
- Ideal for high-performance work, and for installing Bronze-Wall® guide inserts or thin-wall liners (pages 33-35)

Size	Range	Order No.
.500"	.496" -.504"	VGC-502
.530"	.526" -.534"	VGC-530
.566"	.562" -.570"	VGC-566

Jobber ea. \$9.99

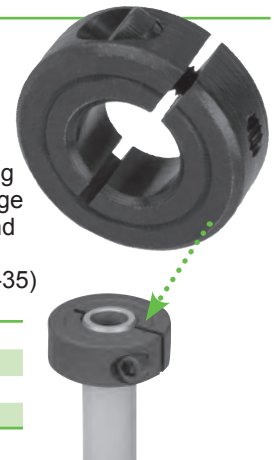

CYLINDER HEAD REBUILDING

CLEANING, ASSEMBLY & SAFETY

SHORT BLOCK REBUILDING

FLYWHEEL, GRINDING

CRANKSHAFT/

MISCELLANEOUS TOOLS & SUPPLIES

TOOLING

MEASURING TOOLS

V-TWIN & METRIC HARD PARTS

full service
...fast



"Many of our products aren't satisfactory, we want you to send it back...we have a no hassle return policy. Just send it back, freight pre-paid within 30 days and we'll exchange it, fix it or credit your account for the amount of the purchase."

Nancy, Goodson Warehouse Manager, 24 years of service



Truing Sleeve

Adaptor

P-180
Hone Head

Honing Stone

Wedge (included with
Mandrel)

Mandrel

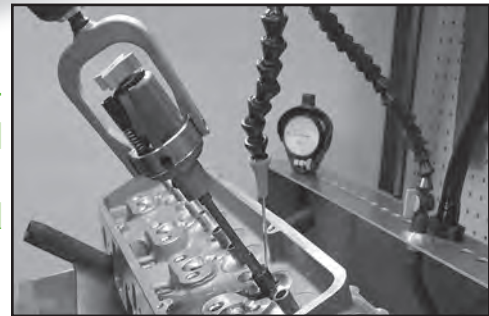

Valve Guide Hone Set

- Sets-up fast • Easy to use!
- Produces straight, round holes for top-quality work
- Ideal for high-performance applications
- Use a low RPM, 1/2" drill for driving power (200 RPM max.)
- Sunnen® tooling is NOT interchangeable with Goodson Hyper-Finish (page 28)

Description	Jobber	Order No.
Sunnen Honall® Valve Guide Hone Set	\$803.64	P-190
Includes: Head & Driver. Mandrels & Sleeves (1 of ea. for sizes - 5/16", 1/2", 3/8", & 7/16")		
Adaptors: (1) PK10-A & (1) PK12-A. Stones L10-J69 & L12-J67. Case & instructions		
Sunnen Honall® Valve Guide Hone Head & Driver only	\$381.88	P-180

Ordering Information: The head and driver are interchangeable with the adaptors.

tech tips

from the techxperts™

Only one head and driver is required. Mandrels are available to cover all popular sizes. Please select from the parts in the photo above and order per size range desired. We suggest you have an adaptor for each mandrel to save change-over time between sizes.

BL Mandrels (Order Mandrel, Sleeve, Stones, Adaptor & Stone Retainer Separately)

Size	Inch	mm	Mandrel		Sleeve		Roughing Stones		Finishing Stones		Adaptor		Stone Retainer	
			Jobber	Order No.	Jobber	Order No.	Jobber	Order No.	Jobber	Order No.	Jobber	Order No.	Jobber	Order No.
5mm	.195"-.200"	4.9-5.1	\$39.46	BL6-195CS	\$12.02	S-195	\$71.11	L6-J47 (12)	\$71.11	L6-J67 (12)	\$79.99	PSK6-A‡	\$10.46	LN-3087C
5.5mm	.210"-.215"	5.3-5.5	39.30	BL6-210CS	11.67	S-210	71.11	L6-J47 (12)	71.11	L6-J67 (12)	79.99	PSK6-A‡	10.46	LN-3087C
	.215"-.220"	5.5-5.6	39.40	BL6-215CS	11.35	S-215	71.11	L6-J47 (12)	71.11	L6-J67 (12)	79.99	PSK6-A‡	10.46	LN-3087C
6mm	.225"-.230"	5.7-5.8	36.74	BL6-225CS	11.35	S-225	71.11	L6-J47 (12)	71.11	L6-J67 (12)	79.99	PSK6-A‡	10.46	LN-3087C
	.230"-.235"	5.8-6.0	39.58	BL6-230CS	12.02	S-230	71.11	L6-J47 (12)	71.11	L6-J67 (12)	79.99	PSK6-A‡	10.46	LN-3087C
6mm	.235"-.240"	6.0-6.1	38.47	BL6-235CS	11.67	S-235	71.11	L6-J47 (12)	71.11	L6-J67 (12)	79.99	PSK6-A‡	10.46	LN-3087C
	.245"-.250"	6.2-6.4	37.72	BL8-245AS	12.02	S-245	39.44	L8-J47 (6)	39.44	L8-J67 (6)	76.74	PK8-A	-----	-----
1/4"	.250"-.255"	6.4-6.5	38.83	BL8-250AS	12.02	S-250	39.44	L8-J47 (6)	39.44	L8-J67 (6)	76.74	PK8-A	-----	-----
	.255"-.260"	6.5-6.6	38.47	BL8-255AS	12.02	S-255	39.44	L8-J47 (6)	39.44	L8-J67 (6)	76.74	PK8-A	-----	-----
7mm	.270"-.275"	6.8-7.0	37.72	BL8-270AS	12.68	S-270	39.44	L8-J47 (6)	39.44	L8-J67 (6)	76.74	PK8-A	-----	-----
	.275"-.280"	7.0-7.1	38.55	BL8-275AS	12.68	S-275	39.44	L8-J47 (6)	39.44	L8-J67 (6)	76.74	PK8-A	-----	-----
5/16" ♦	.308"-.316"	7.8-8.0	40.04	BL10-308AS	12.68	S-308	40.14	L10-J47 (6)	41.43	L10-J69 (6)	74.62	PK10-A	-----	-----
11/32" ♦	.339"-.347"	8.6-8.8	40.20	BL10-339AS	12.68	S-339	40.14	L10-J47 (6)	41.43	L10-J69 (6)	74.62	PK10-A	-----	-----
23/64"	.354"-.362"	9.0-9.2	39.09	BL10-354AS	12.68	S-354	40.14	L10-J47 (6)	41.43	L10-J69 (6)	74.62	PK10-A	-----	-----
3/8"	.370"-.385"	9.4-9.8	41.35	BL12-370AS	17.40	S-370	45.32	L12-J47 (6)	45.32	L12-J67 (6)	74.62	PK12-A	-----	-----
7/16" ♦	.432"-.447"	11.0-11.4	39.38	BL12-432AS	17.40	S-432	45.32	L12-J47 (6)	45.32	L12-J67 (6)	74.62	PK12-A	-----	-----

♦ Included in set Order No. P-190 ‡NOTE: Remove the stone retainer included with the PSK6-A and replace with LN-3087C for valve guide honing



Minnesota Fast Freeze

- Instantly chills seats & guides to -50°F (-45.5°C) • Creates interference fit with heated aluminum heads • Finish seat and guide work faster than ever • Aerosol*
- Use on tight bushings, pins, shafts, etc.
- Order No. MFF-8 Jobber \$29.99

*Hazardous Goods Fees Apply When Shipped by Air

Press Fit Lubricants

- A light coat eases press fit
- Ideal for valve guides, piston pins, cylinder sleeves, etc.
- Eliminates the scoring, gouging and galling of parts during press fitting



Description	Jobber	Order No.
Goodson Aerosol* 6 oz. (170 g)	\$12.99	PFL-200*
Sunnen® Aerosol* 7 oz. (198 g)	18.06	B-200*
Sunnen® Brush Applicator 200 mL (not shown)	24.59	B-200L

*Hazardous Goods Fees Apply When Shipped By Air

Buy 12 or more PFL-200 and SAVE 10% off jobber



CYLINDER HEAD REBUILDING
CLEANING, ASSEMBLY & SAFETY
SHORT BLOCK REBUILDING
CRANKSHAFT/ FLYWHEEL GRINDING
MISCELLANEOUS TOOLS & SUPPLIES
BRAKE SERVICE TOOLING
MEASURING TOOLS
V-TWIN & METRIC HARD PARTS



Valve Guide Replacement

Valve Guide Drivers

- Corrosion-resistant finish 1° negative angle prevents guides from spreading • Rockwell hardness of 45-50
- Pilots are slightly smaller than guide ID for easy removal

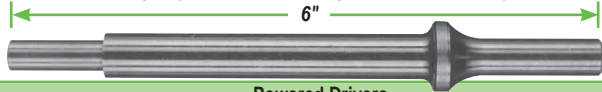

Powered Drivers			
Standard Sizes	Jobber	Order No.	Incl.
4-piece Kit	\$62.99	PH-2226-G	▼
Guide ID /mm	Driver OD	Pilot	
.312" / 7.92	.487" / 12.4	.300" / 7.62	\$19.99 PH-2228A-G
.312" / 7.92	.423" / 10.7	.304" / 7.72	19.99 PH-2228-G
.343" / 8.71	.422" / 10.7	.336" / 8.53	19.99 PH-2229A-G
.343" / 8.71	.487" / 12.4	.337" / 8.56	19.99 PH-2229-G
.372" / 9.47	.487" / 12.4	.367" / 9.32	19.99 PH-2231-G
.437" / 11.10	.612" / 15.5	.429" / 10.90	19.99 PH-2230-G
Metric Sizes	Jobber	Order No.	Incl.
6-piece Kit	\$94.99	PH-2600-G	▼
Guide ID /in.	Driver OD	Pilot	
5.0mm / .196"	9.0 / .355"	4.75 / .187"	\$19.99 PH-2250-G
5.5mm / .217"	10.5 / .412"	5.21 / .205"	19.99 PH-2255-G
6.0mm / .236"	10.5 / .412"	5.72 / .225"	19.99 PH-2260-G
6.6mm / .260"	11.8 / .463"	6.30 / .248"	19.99 PH-2234-G
7.0mm / .275"	11.0 / .432"	6.60 / .260"	19.99 PH-2235-G
8.0mm / .315"	11.7 / .462"	7.80 / .307"	19.99 PH-2236-G
9.0mm / .353"	12.4 / .487"	8.81 / .347"	19.99 PH-2237-G
10mm / .393"	15.5 / .612"	8.56 / .387"	19.99 PH-2238-G
11mm / .433"	15.5 / .612"	10.85 / .427"	19.99 PH-2239-G

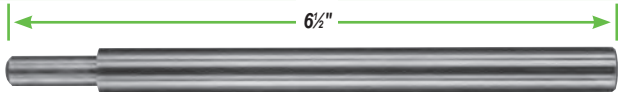

Manual Drivers			
Standard Sizes	Jobber	Order No.	Incl.
4-piece Kit	\$58.99	GP-500A-G	▼
Guide ID /mm	Driver OD	Pilot	
.312" / 7.92	.422" / 10.7	.305" / 7.75	\$18.99 GP-431-G
.312" / 7.92	.487" / 12.4	.302" / 7.67	18.99 GP-531-G
.343" / 8.71	.422" / 10.7	.336" / 8.53	18.99 GP-533-G
.343" / 8.71	.487" / 12.4	.336" / 8.53	18.99 GP-534-G
.372" / 9.47	.487" / 12.4	.367" / 9.32	18.99 GP-537-G
.437" / 11.10	.611" / 15.5	.428" / 10.87	18.99 GP-743-G
Metric Sizes	Jobber	Order No.	Incl.
6-piece Kit	\$79.99	GP-600M-G	▼
Guide ID /in.	Driver OD	Pilot	
6.6mm / .260"	11.7 / .462"	6.22 / .245"	\$18.99 GP-6.6MM-G
7mm / .275"	10.7 / .422"	6.78 / .267"	18.99 GP-7MM-G
8mm / .315"	12.3 / .486"	7.77 / .306"	18.99 GP-8MM-G
9mm / .353"	12.3 / .485"	8.84 / .348"	18.99 GP-9MM-G
10mm / .393"	15.5 / .611"	9.80 / .386"	18.99 GP-10MM-G
11mm / .433"	15.5 / .611"	10.82 / .426"	18.99 GP-11MM-G



Air Hammer

- Delivers 3500 blows per minute
- Weighs 3 lbs.
- .401" tool opening

Description	Jobber	Order No.
Air Hammer	\$77.99	AH-335
Replacement Retainer Spring	9.99	AH-5RS

Universal Driver Tool

- Sized to extend Diesel Guide Drivers at right
- 4.75" OAL
- .401" ID
- Order No. **CL-7333** Jobber \$39.99

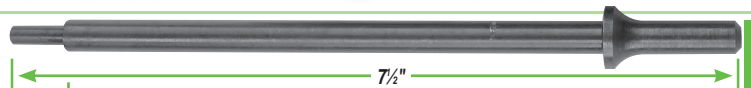

Extra-Long Powered Valve Guide Drivers

- For use with overhead cam heads
- 1° negative angle to prevent guide mushrooming • Pilots are slightly smaller than guide ID • 7.5" long

Guide ID / in.	Driver OD	Pilot	Jobber	Order No.
4.0mm / .157"	9.0 / .355"	3.80 / .150"	\$22.99	PHL-2240-G
4.5mm / .177"	9.0 / .355"	4.30 / .170"	22.99	PHL-2245-G
5.0mm / .196"	9.0 / .355"	4.75 / .187"	22.99	PHL-2250-G
5.5mm / .217"	10.5 / .412"	5.21 / .205"	22.99	PHL-2255-G
6.0mm / .230"	9.1 / .358"	5.72 / .225"	22.99	PHL-2258-G
6.0mm / .236"	10.5 / .412"	5.72 / .225"	22.99	PHL-2260-G
6.6mm / .260"	11.8 / .463"	6.29 / .248"	22.99	PHL-2234-G
7.0mm / .275"	11.0 / .432"	6.60 / .260"	22.99	PHL-2235-G
7.9mm / .312"	10.7 / .423"	7.72 / .304"	22.99	PHL-2228-G
8.0mm / .315"	11.7 / .462"	7.80 / .307"	22.99	PHL-2236-G
8.7mm / .343"	12.4 / .487"	8.56 / .337"	22.99	PHL-2229-G
9.5mm / .375"	12.4 / .487"	9.32 / .367"	22.99	PHL-2231-G



Extra Long Manual Valve Guide Drivers

- 8" OAL • Pilot approximately 1" long
- NOTE:** Due to the nature of these valve guide drivers, they cannot be warranted against breakage, but are guaranteed for dimensional accuracy.

Guide ID / in.	Driver OD	Pilot	Jobber	Order No.
4.0mm / .157"	9.0 / .355"	3.80 / .150"	\$20.99	GPL-2240-G
4.5mm / .177"	9.0 / .355"	4.30 / .170"	20.99	GPL-2245-G
5.0mm / .196"	9.0 / .355"	4.75 / .187"	20.99	GPL-2250-G
5.5mm / .217"	10.5 / .412"	5.21 / .205"	20.99	GPL-2255-G
6.0mm / .230"	9.1 / .358"	5.72 / .225"	20.99	GPL-2258-G
6.0mm / .236"	10.5 / .412"	5.72 / .225"	20.99	GPL-2260-G

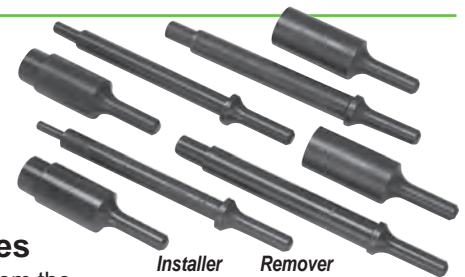

Air-Powered Valve Guide Drivers for Diesel Engines

- Drive guides in from the shoulder instead of from the top
- Installing drivers have the proper recess to drive guides in for the correct installed height • Remove / Install guides faster – no measuring necessary • For most standard pneumatic tools

Application	Installer Major / Counter Bore ID	Order No.	Remover Shank/Pilot OD	Order No.
Cummins	.752" / .503"	DVG-Ci	.595" / .450"	DVG-CR
Cummins 8.3 6CT	.552" / —	DVG-8.3	.491" / .304"	DVG-71R
Caterpillar 3116	.515" / .475"	DVG-3116	.491" / .304"	DVG-71R
Caterpillar 3126	.633" / .506"	DVG-3126	.595" / .354"	DVG-3468R
Caterpillar 3306	.660" / —	DVG-3306	.595" / .354"	DVG-3468R
Caterpillar 3406-3408	.709" / —	DVG-3468i	.595" / .354"	DVG-3468R
Caterpillar 3406-3408B	.632" / —	DVG-3468Bi	.595" / .354"	DVG-3468R
Detroit GMC 53	.502" / .421"	DVG-53i	.491" / .246"	DVG-53R
Detroit GMC 71/92	.502" / .435"	DVG-71i	.491" / .304"	DVG-71R
International DT 466	.640" / .440"	DVG-466i	.595" / .354"	DVG-3468R

Jobber \$29.99

Jobber \$29.99



"We take our job of getting your order to you quickly very seriously. We use several different carriers allowing us to get your products to you when you need them at a price you can afford."

- Becky, Goodson Shipping, 5 years of service

CYLINDER HEAD
REBUILDING

CLEANING,
ASSEMBLY & SAFETY

SHORT BLOCK
REBUILDING

CRANKSHAFT/
FLYWHEEL GRINDING

MISCELLANEOUS
TOOLS & SUPPLIES

BRAKE SERVICE
TOOLING

MEASURING
TOOLS

V-TWIN & METRIC
HARD PARTS

tech tips Install guides to same height every time!
from the techxperts™

American Made



Pneumatic Driver Body (AVG-1)

Locking Nut (AVG-2) and installation sleeve have flats for positive lock and release adjustment.

Adjustable installation sleeve (AVG-3) adjusts from 0" to 1 1/4" guide height and fits guides to .700" OD.

Adjustable Powered Valve Guide Driver With Replaceable Pilots

- Standardize the correct installed height on one guide then repeat it on all others
- Screw-in pilots with 5/16" - 18 threads • 6 1/2" overall length

Description	Jobber	Order No.	Includes
Standard Valve Guide Driver Kit	\$129.99	AVG-STD	▼
Metric Valve Guide Driver Kit	129.99	AVG-MM	▼
Pneumatic Body Only 5/8"-18 thread	49.99	AVG-1	x x
Installation Sleeve	24.99	AVG-3	x x
Locking Nut	10.99	AVG-2	x x
Replaceable Pilots	Diameter		
	.312"	\$21.99 AVG-312	x
	.343"	21.99 AVG-343	x
	.372"	21.99 AVG-372	x
	.437"	21.99 AVG-437	x
	5.0mm	21.99 AVG-5MM	x
	5.5mm	21.99 AVG-55MM	
	6.0mm	21.99 AVG-6MM	x
	6.6mm	21.99 AVG-66MM	
	7.0mm	21.99 AVG-7MM	x
	8.0mm	21.99 AVG-8MM	x
	9.0mm	21.99 AVG-9MM	

Use thread locker on pilot to resist loosening while in use.



Cast Iron and Manganese Bronze Valve Guides for Harley-Davidson on page 123

Universal Repair Guides

- Unfinished ID ready to be reamed with Goodson's exclusive carbide reamers (page 27)
- Manganese bronze

ID	OD	Length	Jobber	Order No.
7.0mm	.740"	2.700"	\$9.99	UVBG-7MM
.308"	.740"	2.700"	9.99	UVBG-308
.341"	.740"	2.700"	9.99	UVBG-341
.372"	.740"	2.700"	9.99	UVBG-372

Valve Guide OD Machining Tool Does 3 Jobs at Once!

- Face the guide top to the correct size
- Sizes the guide OD for press-on seals
- Chamfers the top to prevent seal damage
- Cutters & pilots are interchangeable and chuck into any portable drill, drill press or seat & guide machine



Individual Cutters

Guide OD	Order No.
.415"	10.5 VSC-415
.428"	10.8 VSC-428
.475"	12.1 VSC-475
.495"	12.6 VSC-495
.500"	12.7 VSC-500
.530"	13.5 VSC-530
.562"	14.3 VSC-562
.625"	15.9 VSC-625
Jobber ea.	\$77.99

Pilots

Guide ID	Order No.
5/32"	7.0 VP-7MM
5/16"	7.9 VP-312
11/32"	8.7 VP-343
3/8"	9.5 VP-375
Jobber ea.	\$31.99

Cutter and Pilot Assemblies

Guide OD	Pilot Size	Order No.
.415"	10.5 5/16"	7.9 VSC-415312
.428"	10.9 5/16"	7.9 VSC-428312
.475"	12.1 5/16"	7.9 VSC-475312
.500"	12.7 5/16"	7.9 VSC-500312
.500"	12.7 11/32"	8.7 VSC-500343
.500"	12.7 3/8"	9.5 VSC-500375
.530"	13.5 5/16"	7.9 VSC-530312
.530"	13.5 11/32"	8.7 VSC-530343
.530"	13.5 3/8"	9.5 VSC-530375
.562"	14.3 11/32"	8.7 VSC-562343
.562"	14.3 3/8"	9.5 VSC-562375
.625"	15.9 3/8"	9.5 VSC-625375
Jobber ea.		\$97.29

The more guides you buy, the more you save!

Buy 25 - 50 guides, save 10% off jobber.

Buy 51+ guides, save 15% off jobber

(mix & match sizes)



Harley valve guides on page 124

Cast Iron False Valve Guides

Universal Applications

ID	OD	Length	Jobber	Order No.
.312"	.439"	2.281"	\$3.99	CIG-312
.342"	.502"	3.062"	3.99	CIG-342
.372"	.502"	2.750"	3.99	CIG-372
.343"	.564"	2.750"	3.99	OG-343
.373"	.564"	2.750"	3.99	OG-373

24 Valve 7mm Cummins Diesel (.511" seal surface) see tooling, page 26

ID	OD	Length	Jobber	Order No.
Intake .275"	.502"	1.940"	\$3.99	CIG-3021
Exhaust .275"	.502"	2.020"	3.99	CIG-3022

Ford 6.0L (.513" x 659" seal surface) see tooling, page 26

ID	OD	Length	Jobber	Order No.
.275"	.4395"	2.332"	\$3.99	CIG-3055

7.3 Powerstroke Use with Core Drill Reamer CDR-563-CB, page 26

ID	OD	Length	Jobber	Order No.
.3146"	.5652"	2.440"	\$3.99	CIG-8476

Manganese Bronze False Valve Guides

Universal Applications

ID	OD	Length	Jobber	Order No.
.311"	.439"	3.062"	\$6.99	BVG-311
.343"	.502"	2.375"	4.99	BVG-343
.372"	.502"	2.375"	4.99	BVG-372

Knurling Arbors

- Piloted for positive centering
- Use by hand or with electric drill & speed reducer
- **Not for use on chilled, hardened or bronze guides**

Inch	mm	Jobber	Order No.
.236"	6.00	\$97.99	WKA-6MM-G
.275"	7.00	97.99	WKA-7MM-G
.312"	7.92	97.99	WKA-312-G
.343"	8.71	97.99	WKA-343-G
.375"	9.53	97.99	WKA-375-G
1 Quart Knurlube (946.6mL)		14.79	WLB-47-G

NOTE: We don't stock knurling arbors smaller than 6mm because smaller guides are chilled and these arbors may fail.

tech tips
from the techxperts™
Use with
Knurlube



Electric Drill Drive Adaptors For Knurling Arbors and/or Reamers

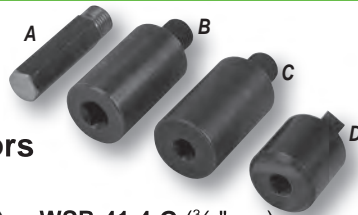

Use **WSR-41-3-G** (1/4" sq.) or **WSR-41-4-G** (3/16" sq.) with **WSR-41-7-G** (3/8" drill adaptor). Clamp 3/8" drive in drill to drive reamers directly.

Description	Jobber	Order No.
A Drill Adaptor for 3/8" drill	\$ 8.99	WSR-41-7-G
B 1/4" Adaptor for arbors/reamers larger than .281"	10.99	WSR-41-3-G
C 3/16" Adaptor for arbors/reamers .281" or smaller	14.99	WSR-41-4-G
D Slip on Adaptor (converts WSR-41-3-G to .1875")	20.99	WSR-41-5-G

Knurlube

- High pressure lube prevents tool damage
- Extends knurler life by reducing friction and arbor wear



Size	Jobber	Order No.
8 oz. / 236.6mL	\$10.49	WLB-46-G
32 oz. / 946.4mL	14.79	WLB-47-G

Bronze Reaming Oil

- Prevents build-up
- Extends reamer life
- Improves valve guide finish



Size	Jobber	Order No.
16 oz. / 473.2mL	\$ 9.99	BW-303-G
32 oz. / 946.4mL	15.99	BW-303A-G
1 Gal. / 1.893L	35.99	BW-305-G

Valve Guide OD Knurling Tool

- Enlarge guides to fit bore
- Ideal for rare metric sizes and aluminum heads with damaged guide bores
- Works on most materials, **except** chilled or hardened guides



tech tips
from the techxperts™
Hold guide firmly in Vise, Drill Press or Seat & Guide machine; tighten the knurler and turn it around the guide by hand. Increase OD up to .002".

Description	Jobber	Order No.
Complete Tool	\$59.99	VGK-25
Replacement Knurling Wheel	24.99	VGK-25W
Replacement Knurling Rollers (2)	10.99	VGK-25R

Bronze-Wall® Bushings

- Spiral inserts rebuild cast-iron guides worn .030"
- Highly durable Phosphor-Bronze
- Thread easily into tapped bore
- Helps guides and stems last longer
- .038" wire for reamed guides

Size	Qty.	Jobber	Order No.
Standard Bushings			
1 1/32"	50	\$73.99	BW-020B-G
3/8"	50	73.99	BW-050B-G

The more you buy, the more you save!

2-4 boxes of bushings, save 10% off jobber.
5 or more boxes, save 20% off jobber

Bronze bushings thread easily into tapped bores. Replace guides at any time by simply uncoiling the old ones.



Bronze-Wall® 2 Bushings

- Spiral inserts rebuild cast-iron guides worn .030"
- Highly durable Phosphor-Bronze
- Thread easily into tapped bore
- Helps guides and stems last longer
- .035" wire for broached guides
- Easy to install and size using Sizing Ball and Driver instead of Broach and Reamer

Size	Qty.	Jobber	Order No.
Standard Bushings			
1 1/32"	50	\$73.99	BW2B-343
3/8"	50	73.99	BW2B-375

tech tips

from the techxperts™

Right Hand Rotation Only.

For best results, keep your RPM about the same as your hone RPM, use the same rate of speed and number of strokes per minute.

Ultra-Finish Plateau Valve Guide Soft Hones

- Use AFTER guide honing to remove microscopic peaks and scuffs without enlarging the guide ID
- Abrasive impregnated nylon bristles
- Use with liberal amounts of honing oil
- Not interchangeable with Flex-Hones®
- Use with your portable drill or seat and guide machine

Hole Diameter	Hone	Head	Overall	Jobber	Order No.	
in	mm	Dia.	Length	Length		
.2187"	5.5	.241"	1.00"	4.00"	\$10.49	UF-5.5MM
.2500"	6.4	.275"	1.25"	4.50"	10.49	UF-6.4MM
.2813"	7.0	.309"	1.25"	4.50"	12.49	UF-7MM
.3125"	8.0	.343"	1.25"	4.50"	12.49	UF-8MM
.3437"	9.0	.378"	1.25"	4.50"	12.49	UF-9MM
.3750"	10.0	.413"	1.25"	4.50"	12.49	UF-10MM

NOTE: Larger size Ultra-Finish hones on page 81

CYLINDER HEAD
REBUILDING

CLEANING,
ASSEMBLY & SAFETY

SHORT BLOCK
REBUILDING

CRANKSHAFT/
FLYWHEEL GRINDING

MISCELLANEOUS
TOOLS & SUPPLIES

BRAKE SERVICE
TOOLING

MEASURING
TOOLS

V-TWIN & METRIC
HARD PARTS



"Did you know that Goodson still ships orders COD? If you prefer not to use a credit card or set up an open account, you can still order from Goodson. Ask us about COD."

- Pam, Goodson Accounting, 17 years of service

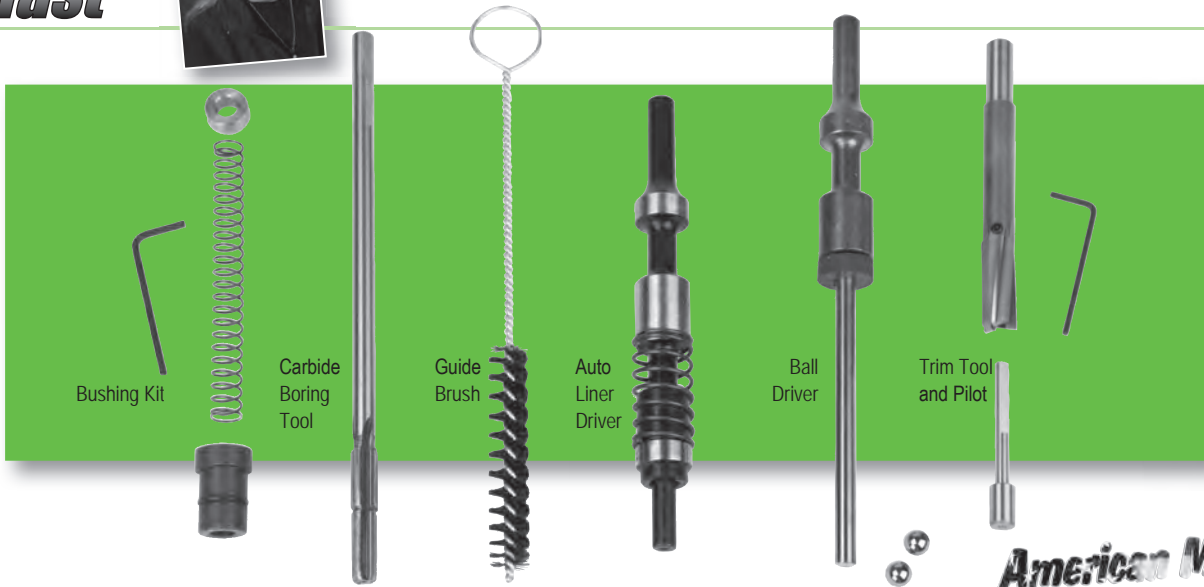

American Made

6.0mm to 3/8" Bronze-Liner Installation Tool Kits

Phosphor-Bronze is an ideal valve guide material – it's more durable than cast iron, conducts heat away faster and retains lubrication better to reduce wear. Install rugged, thin-wall (.030") Bronze-Liners in cast iron or aluminum heads to repair guides and deliver performance better than new! Plus, Bronze-Liners install quickly with simple tools. If a Bronze-Liner ever wears out, you can quickly and easily replace it with a new one to restore performance. **Removal Tools, page 35.**

Kits include ▼	6.0mm Guides		7.0mm Guides		5/16" Guides	
Master Tool Kits	\$574.99	CL-6MM	\$574.99	CL-7MM	\$574.99	CL-312
Carbide Boring Tool	207.99	CL-2024C	207.99	CL-2007C	207.99	CL-2005C
Bushing Kit	21.79	CL-2003	23.49	CL-2001	23.49	CL-2000
Ball Driver	89.79	CL-4452P	89.79	CL-4446P	89.79	CL-4444P
Carbide Sizing	49.99 .2370"	CL-5237	49.99 .2770"	CL-5277	49.99 .3125"	CL-53125P
Balls	49.99 .2380"	CL-5238	49.99 .2780"	CL-5278	49.99 .3130"	CL-5313
Auto-Driver	119.99	CL-3600	119.99	CL-3507	119.99	CL-3500
Trim Tool	76.49 .402" OD	CL-5602	76.49 .500" OD	CL-5600	76.49 .500" OD	CL-5300
Trim Tool Pilot	20.49	CL-5634	20.49	CL-5626	20.49	CL-5620
Guide Brush	6.99	GVP-10N	3.99	WCB-44	3.99	WCB-44

When Working By Hand, Kits Require Seat Centering Cones - See Chart Below

Kits include ▼	8.0mm Guides		11/32" Guides		3/8" Guides	
Master Tool Kits	\$574.99	CL-8MM	\$574.99	CL-343	\$574.99	CL-375
Carbide Boring Tool	207.99	CL-2008C	207.99	CL-2012C	207.99	CL-2014C
Bushing Kit	23.49	CL-2000	23.49	CL-2000	23.49	CL-2000
Ball Driver	89.79	CL-4444P	89.79	CL-4444P	89.79	CL-4444P
Carbide Sizing	49.99 .3160"	CL-5316	49.99 .3440"	CL-5344	49.99 .3750"	CL-5375
Balls	49.99 .3170"	CL-5317	49.99 .3445"	CL-53445	49.99 .3760"	CL-5376
Auto-Driver	119.99	CL-3500	119.99	CL-3504	119.99	CL-3506
Trim Tool	76.49 .500" OD	CL-5600	76.49 .500" OD	CL-5600	76.49 .500" OD	CL-5600
Trim Tool Pilot	20.49	CL-5620	20.49	CL-5622	20.49	CL-5624
Guide Brush	3.99	WCB-44	3.99	WCB-44	3.99	WCB-44

tech tips

from the techxperts™

The centering cone must fit the valve seat properly so using the correct size is essential. This is NOT a one-size-fits-all tool. If you have a cone that is too small for the seat it could slip through the opening. If you have one that's too large, the side of the combustion chamber could interfere or you won't have enough of the cone in the seat area for it to be stable and centered.



60° Seat Centering Cones

- Center firmly in the valve seat
- Cones feature a .625" ID
- Steel construction
- Use the Seat Centering Cones with the Master Tool Kits (above) for proper alignment of the reamer and guide bore

Description	Jobber	Order No.
7 Piece Kit	\$221.99	CL-6500 ▼
Nominal Range		
1"	0.970"-0.730"	\$39.99 CL-6310 x
1¼"	1.230"-0.740"	39.99 CL-6308 x
1½"	1.475"-0.805"	39.99 CL-6306 x
1¾"	1.730"-0.860"	39.99 CL-6304 x
2"	1.950"-0.875"	39.99 CL-6302 x
2¼"	2.230"-1.000"	39.99 CL-6300 x
2½"	2.550"-1.875"	42.99 CL-6312 x

Bronze-Liners & Tooling

Buy 3 or more sizing balls (any combination) and save 10% off jobber



Carbide Sizing Balls

- Finished to .00008" roundness
- Within the 90 Rockwell range
- The finished ID of the Bronze-Liner will be .001" smaller than the ball used

Size	Order No.	Size	Order No.
6.0mm	.2360" CL-5236	8.0mm	.3150" CL-5315
	.2370" CL-5237		.3160" CL-5316
	.2380" CL-5238		.3170" CL-5317
7.0mm	.2760" CL-5276	1 1/2"	.3430" CL-5343
	.2770" CL-5277		.3435" CL-53435
	.2780" CL-5278		.3440" CL-5344
5/16"	.3120" CL-5312		.3445" CL-53445
	.3125" CL-53125		.3450" CL-5345
	.3130" CL-5313		.3460" CL-5346
	.3140" CL-5314	3/8"	.3730" CL-5373
Jobber ea.	\$49.99		.3740" CL-5374
			.3745" CL-53745
			.3750" CL-5375
			.3755" CL-53755
			.3760" CL-5376
		Jobber ea.	\$49.99

tech tips

from the techxperts™

Always be sure to hold your hand under the cylinder head to catch the carbide ball as it comes out of the guide.

Phosphor-Bronze liners outlast original guides and are easy to replace

Thin-Wall .030" Bronze-Liners

- Outlast original guides
- Cross-hatch promotes oil retention
- Rounded nose design makes installation quick and easy
- Stripe helps you identify rounded end
- Phosphor-bronze

tech tips

from the techxperts™

NOTE: 5.0 & 5.5mm Guides do NOT interchange with competitors' guides. You MUST use our tooling with these guides.

Guide Size	Liner Size	OD	Length	Box of 16		Box of 100	
				Jobber	Order No.	Jobber	Order No.
5.0mm	+ .030"	2.00"	\$19.99	CL-500	\$77.99	CL-500A	
5.5mm	+ .030"	2.50"	19.99	CL-550	77.99	CL-550A	
6.0mm	+ .030"	2.50"	19.99	CL-600	77.99	CL-600A	
7.0mm	+ .030"	2.50"	19.99	CL-700	77.99	CL-700A	
.312"	+ .030"	2.50"	19.99	CL-1220	77.99	CL-1220A	
8.0mm	+ .030"	2.50"	19.99	CL-1420	77.99	CL-1420A	
.343"	+ .030"	3.00"	19.99	CL-1640	77.99	CL-1640A	
.375"	+ .030"	3.00"	19.99	CL-1830	77.99	CL-1830A	
Oversize Bronze Liners							
.343" +.002"	+ .032"	3.00"	\$19.99	CL-1640-2	\$ 89.99	CL-1640-2A	
.375" +.002"	+ .032"	2.50"	19.99	CL-1820-2	114.99	CL-1820-2A	
.375" +.004"	+ .032"	2.50"	19.99	CL-1820-4	114.99	CL-1820-4A	



Removal Tool

Remove bronze liners without damaging the bore

Description	Jobber	Order No.
6.0mm	\$74.99	CL-7352
7.0mm	74.99	CL-7344
5/16"	74.99	CL-7310
8.0mm	74.99	CL-7320
1 1/2"	74.99	CL-7330
3/8"	74.99	CL-7340

Universal Driver Tool

- Fits all removal tools at left and is designed to work with your air hammer
- .401" ID
- Order No. **CL-7333** Jobber \$39.99



Mitutoyo

Small Hole Gauge Set

- See if rebuilding or replacing is needed by checking actual guide wear
- Check guide bosses for proper interference fit during replacement
- Check and maintain correct stem-to-guide ID clearance
- 4-piece set has combined range of .125" to .500"
- With storage pouch
- Order No. **SHG-5** Jobber \$139.99



Chamfer Tool & T-Wrench

Use these optional accessories to remove any burrs that may be created when trimming the liner to length

Description	Jobber	Order No.
Chamfer Tool	\$26.99	CL-5800
T-Wrench	26.99	CL-5870

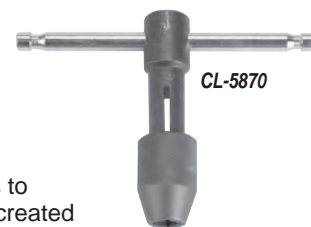

CL-5870



CL-5800

Mitutoyo

Split Ball Bore Gauge

- Dial gauge with large contact area
- Measures quickly & accurately to .0001" (.0025mm)
- Works in threaded or knurled guide IDs
- Range: .280" to .400"
- Easy to change contacts
- Includes molded plastic storage case
- Order No. **MVG-34** Jobber \$629.99



CYLINDER HEAD
REBUILDING

CLEANING,
ASSEMBLY & SAFETY

SHORT BLOCK
REBUILDING

CRANKSHAFT
FLYWHEEL GRINDING

new

MISCELLANEOUS
TOOLS & SUPPLIES

BRAKE SERVICE
TOOLING

MEASURING
TOOLS

V-TWIN & METRIC
HARD PARTS



"We want every aspect of your transaction to be trouble-free. That's why we strive to keep everything as simple for you as possible. We're always looking for new ways to serve you better and we welcome your ideas for how to do that."

- Renee, Goodson Accounting, 27 years of service

CYLINDER HEAD
REBUILDING

CLEANING,
ASSEMBLY & SAFETY

SHORT BLOCK
REBUILDING

CRANKSHAFT/
FLYWHEEL GRINDING

MISCELLANEOUS
TOOLS & SUPPLIES

BRAKE SERVICE
TOOLING

MEASURING
TOOLS

V-TWIN & METRIC
HARD PARTS

Valve Seal Puller

- .810" tool dia.
- Fits Multi-Valve Engines
- Lifts from the bottom of the seal
- Works within the confines of lifter bucket bores
- Fingers grip seal for fast, easy removal
- Works on most domestic and import vehicles
- New and improved seal puller with stronger 3 jaw pulling action.

Description	Jobber	Order No.
Valve Seal Puller	\$199.99	VSP-323
Replacement Shaft	46.99	VSP-323-4
Replacement O-Ring	4.99	VSP-323-5
Replacement Jaw Set	77.99	VSP-323-3
Replacement Jaw Sleeve	43.99	VSP-323-1
Black Split Sleeve	25.99	VSP-323-2

Parts are interchangeable with VSP-320



3 Fingers Grip
Seals Firmly!



Universal Seal Pliers

- Works on OHC and in-line engines with recessed springs
- Long, serrated jaws reach into confined areas and grip seals firmly
- Heat-treated steel with easy-grip handles
- Order No. **VSP-823**
Jobber \$51.99



Valve Stem Seal Puller

- Plier handles rotate to any position above the head while the jaw assembly goes into the spring cavity
- Can be used straight or at any angle up to 90°
- Jaw tip includes thin wedge for "hooking" underneath stubborn valve stem seals
- 4 vertical raised ridges on inner jaw diameter help grip the outside diameter of the seal
- Order No. **VSP-629** Jobber \$51.99

Intake & Exhaust Valve Stem Seals for 24 Valve, 7mm Cummins Diesel

- Fit 7mm valve stems
- OD measures .511"
- Sold in packs of 12



sized for
diesel

Intake

Exhaust

Application	Jobber	Order No.
Intake	\$13.99	CVS-59i
Exhaust	13.99	CVS-59E

Calibrated Spring

- Check Spring Tester Accuracy
- Highest-quality spring steel
- Calibrated to show pressure at a specified compressed height (includes calibration certificate)
- Rating: Min. = 100 lbs.
Max. = 285 lbs.
- Order No. **VST-95** Jobber \$59.99



Conversion Calculator

We've tried to convert as many SAE measurements to Metric (and vice versa) as possible. In some cases there hasn't been enough room.

If you need to convert a measurement, here are the formulas:

Starting Measurement	Conversion Formula	Converted Measurement
Inches (in)	Inches x 25.4	Millimeters (mm)
Feet (ft)	Feet x .3048	Meters (m)
Millimeters (mm)	Millimeters ÷ 25.4	Inches (in)
Fahrenheit (F)	(5÷9) x (F - 32)	Celsius (C)
Celsius (C)	(9÷5) x (C + 32)	Fahrenheit (F)

Height Indicator

- Measure compressed spring height when testing pressure
- Ideal for high performance and checking identical springs
- For Rimac® and other spring testers
- Height Scale displays inches and metric
- Includes Dial Indicator, and Mounting Kit (additional dial indicators on page 121)
- Order No. **VST-25** Jobber \$67.99

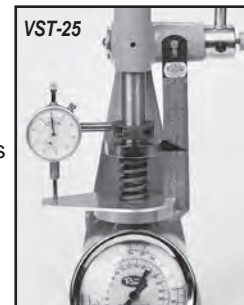

Valve Spring Testing

American Made

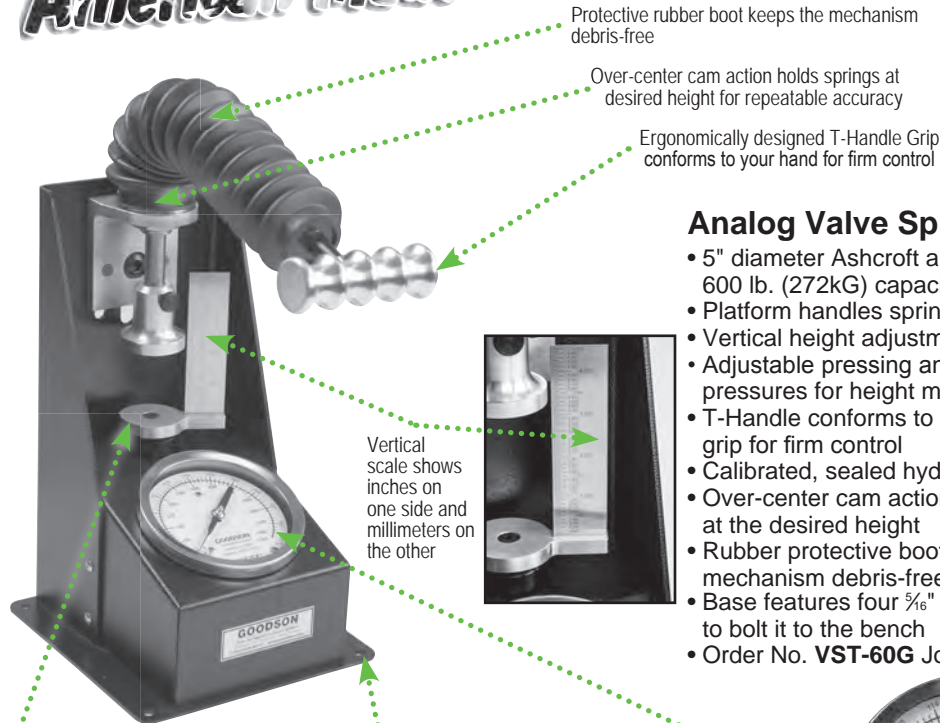

Protective rubber boot keeps the mechanism debris-free

Over-center cam action holds springs at desired height for repeatable accuracy

Ergonomically designed T-Handle Grip conforms to your hand for firm control

Vertical scale shows inches on one side and millimeters on the other

Platform handles springs up to 2" diameter and 4.5" OAL

Base includes four 5/16" holes for securely mounting the Valve Spring Tester to your bench

Easy to read 5" diameter Ashcroft-quality analog pressure gauge shows both pounds and kilograms with 600 pound capacity

Designed to replace Rimac® Spring Testers no longer available

Analog Valve Spring Tester

- 5" diameter Ashcroft analog pressure gauge with 600 lb. (272kG) capacity in 10 lb. (4.54kG) increments
- Platform handles springs up to 2" diameter x 4½" OAL
- Vertical height adjustments in ¼" increments
- Adjustable pressing anvil for fine-tuning open and closed pressures for height measurement
- T-Handle conforms to the operator's grip for firm control
- Calibrated, sealed hydraulic load cell
- Over-center cam action holds spring at the desired height
- Rubber protective boot keeps the mechanism debris-free
- Base features four 5/16" mounting holes to bolt it to the bench
- Order No. **VST-60G** Jobber \$799.99

TECHNICAL SPECS:

UNIT WEIGHT: 19½ lbs.

FOOTPRINT: 8½" sq.

HEIGHT: 28" with handle fully extended



Goodson exclusive

CYLINDER HEAD REBUILDING
CLEANING, ASSEMBLY & SAFETY
SHORT BLOCK REBUILDING
CRANKSHAFT/FLYWHEEL GRINDING
MISCELLANEOUS TOOLS & SUPPLIES
BRAKE SERVICE TOOLING
MEASURING TOOLS
V-TWIN & METRIC HARD PARTS



Easy-to-use Travel Stop with adjustable set screws lets you set an exact position, allowing repeated testing at a desired height. Two set screws allow you to adjust for installed spring height and max lift (near coil bind).

Arbor style handle makes compressing springs fast and easy

Integral digital travel readout

5.0" travel capacity will fit almost any spring on the market today

2.0" diameter plates will handle virtually any spring on the market

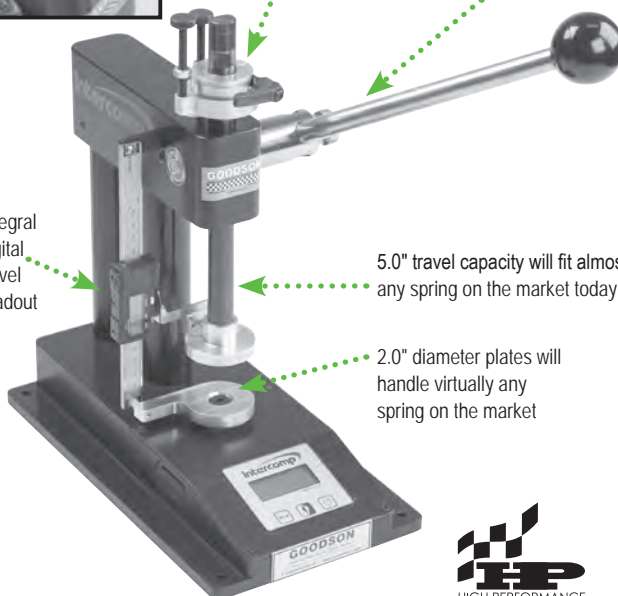

Protect Your Valuable Valve Spring Tester with this Cover!

- Measures 10"x14"x18"
- Same cover fits either Spring Tester
- Heavy-weight, breathable black Sun-Dura® fabric won't hold in moisture
- Order No. **GMC-VST** Jobber \$39.99

More Machine Covers on page 23

Intercomp® Digital Arbor Valve Spring Tester

- 1,500 lb / 680.4 kg load cell in 1 lb. increments
- Force units switchable from pounds to kilograms
- Billet 6061 T-6 Aluminum construction
- Digital travel readout at .001"/inch or .01/mm
- 5" travel capacity • 2.0" diameter spring pads
- Easy to read backlit screen
- Operates on 9V battery (included)
- Adjustable stop to repeatedly check springs at the same heights
- Order No. **VST-2000** Jobber \$1399.99

For routine calibration of spring testers, return tester to Goodson. Call for details, 1-800-533-8010.





Pneumatic Head:
Adjustable to 25° in either direction for canted valves



Head Support:
Table adjusts 45° to the front and 30° to the rear



Positive Stops: Adjusts front and rear angles



Speed Knobs:
Allows quick positioning of workpiece



Foot Pedal:
Easy, hands-free operation



Quick Release Knob:
Allows fast positioning to opposite cam bank

**Goodson
exclusive**

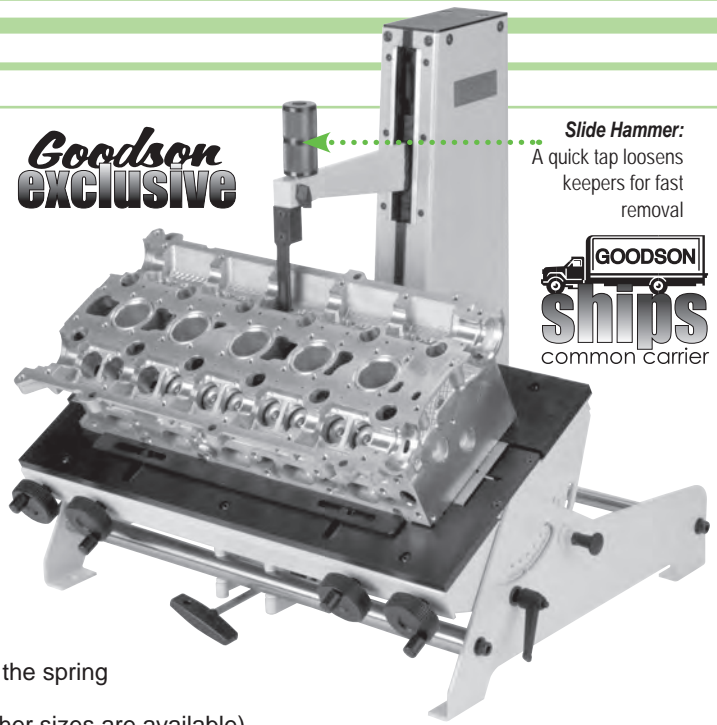

Slide Hammer:
A quick tap loosens keepers for fast removal



Pneumatic Valve Spring Press

- Pneumatic valve support holds valve closed as you compress the spring
- Adjustable stainless steel plate won't damage the head
- 28mm Valve Spring Adaptor (CF-502) is standard with unit (other sizes are available)
- Ideal for use on heads with recessed springs • For aluminum and cast iron heads
- Ships fully assembled • Replacement Parts Available • Measures 28"L x 24"W x 26"H
- Order No. **PSB-5000** Jobber \$4999.99

American Made

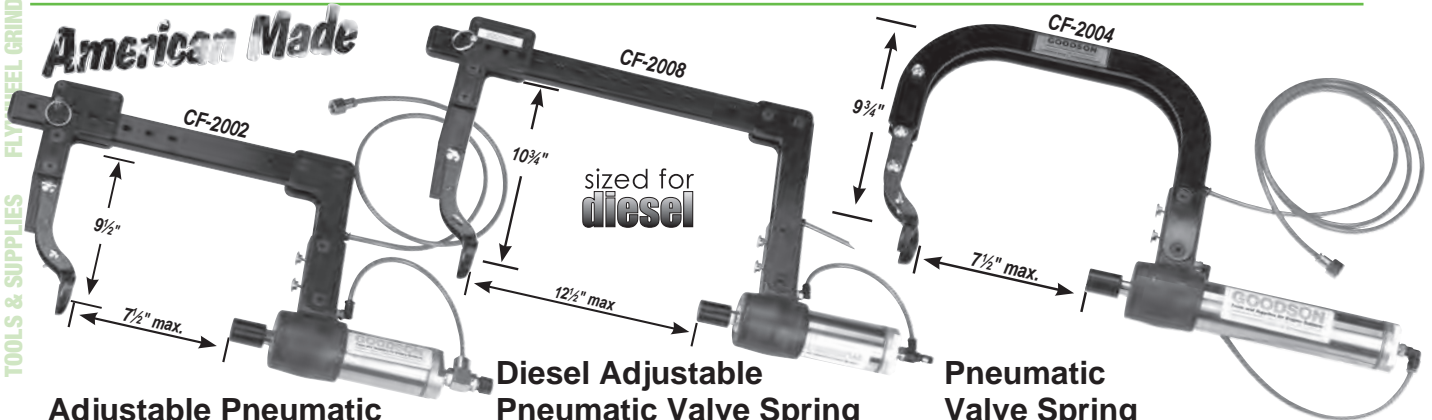

Adjustable Pneumatic Valve Spring Compressor

- Develops up to 325 lbs. of force with 130 PSI
- For springs from 3/4" to 1 3/4" dia.
- CNC-machined 6061 T6 aircraft-quality aluminum frame is adjustable in 1/4" increments
- Includes adjustable jaws (CF-44)
- Stainless steel cylinder with viton grade seals • 2" cylinder travel
- Fingertip controls
- Full 1 year warranty

Description	Jobber	Order No.
Valve Spring Compressor	\$549.99	CF-2002
Replacement Parts and Accessories		
Valve Spring Adaptor Jaw	\$ 13.99	CF-44
1/4" Green Air Line (lin. ft.)	2.99	CF-2001-AL
Air Control Needle Valve	44.99	CF-2001-NV
Int. / Ex. Button	11.99	CF-2003-C
1/2" NPT L-Fitting	6.99	CF-2003-BCE
Air Cylinder 2" Travel	119.99	CF-2001-AC
1/8" NPT L-Fitting	4.99	CF-2003-L

Diesel Adjustable Pneumatic Valve Spring Compressor

- Develops up to 325 lbs. of force with 130 PSI
- For springs from 3/4" to 1 3/4" dia.
- CNC-machined 6061 T6 aircraft-quality aluminum frame is adjustable in 1/4" increments
- Includes adjustable jaws (CF-44)
- Stainless steel cylinder with viton grade seals • 2" cylinder travel
- Fingertip controls
- Full 1 year warranty

Description	Jobber	Order No.
Valve Spring Compressor	\$599.99	CF-2008
Replacement Parts and Accessories		
Valve Spring Adaptor Jaw	\$ 13.99	CF-44
1/4" Green Air Line (lin. ft.)	2.99	CF-2001-AL
Air Control Needle Valve	44.99	CF-2001-NV
Int. / Ex. Button	11.99	CF-2003-C
3/4" NPT L-Fitting	6.99	CF-2003-BCE
Air Cylinder 2" Travel	119.99	CF-2001-AC
1/8" NPT L-Fitting	4.99	CF-2003-L

Pneumatic Valve Spring Compressor

- Develops up to 325 lbs. of force with 130 PSI
- Operates on as little as 90 PSI
- Handles springs from 3/4" to 1 3/4" diameter
- Includes adjustable jaws (CF-44)
- 4" cylinder travel • Steel frame
- Stainless steel cylinder with viton grade seals
- Fingertip controls
- Full 1 years warranty

Description	Jobber	Order No.
Valve Spring Compressor	\$429.99	CF-2004
Replacement Parts and Accessories		
Valve Spring Adaptor Jaw	\$ 13.99	CF-44
1/4" Green Air Line (lin. ft.)	2.99	CF-2001-AL
Air Control Needle Valve	44.99	CF-2001-NV
Intake and Exhaust Button	11.99	CF-2003-C
1/2" NPT L-Fitting	6.99	CF-2003-BCE
Air Cylinder 4" Travel	119.99	CF-2003-AC
1/8" NPT L-Fitting	4.99	CF-2003-L

Valve Spring Compressors

**Goodson
exclusive**

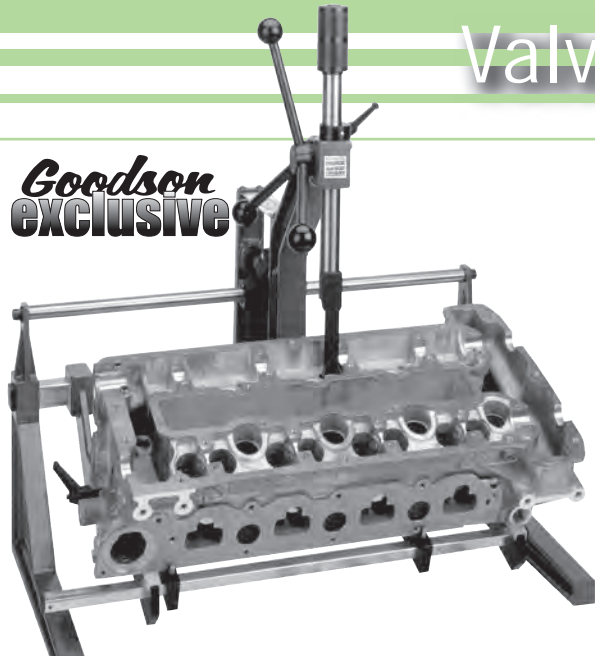

Speed Up Valve Spring Replacement With The Manual Valve Spring Bench

- Remove and install valve springs on heads with recessed springs
- 26"L x 22"W x 35"H footprint and weighs 31 lbs.
- Includes 28mm dia. spring adaptor (CF-502), other size spring adaptors also available (see chart below)
- Locking collar can be used to stop vertical travel or to keep the spring compressed while assembling keepers
- Frame tilts up to 25° in either direction for canted valves
- Full cylinder head support is adjustable from 0 to 45°
- Integral slide hammer easily releases stuck keepers
- Replacement parts available
- Order No. **CF-500** Jobber \$1699.99

Keeper Tools on p. 40-41



Lock Collar:
Can be used to stop vertical travel or to hold spring compressed while assembling keepers



Adjustable Frame:
Adjustable to 25° in either direction for canted valves



Locking Arm:
Holds the C-frame securely in position at the desired angle



Head Support:
Adjustable from 0-45° and locks in place



Dowel Pins:
Keeps the workpiece in place at any head support angle



Slide Hammer:
A quick tap releases keepers that are stuck in retainers

Spring Adaptors for Valve Spring Benches

- Fit both manual (CF-500) and pneumatic (PSB-5000) spring benches
- 1/2" pin diameter
- Solid steel construction with nylon wear insert
- Nylon insert is replaceable



Description	Reach	Jobber	Adaptor	Jobber	Insert
18mm	4 1/2"	\$259.99	CF-518	\$21.99	CF-518-1
23mm	4 1/2"	259.99	CF-501	21.99	CF-501-1
28mm	3 1/2"	259.99	CF-502	21.99	CF-502-1
35mm	2 1/2"	259.99	CF-503		insert not required



Valve Spring Adaptor Jaws

- Fit frames with double locking screws to secure jaws such as Goodson **CF-2002**, **CF-2004**, **CF-2008** and **CF-140** • Heavy duty jaws are non-adjustable (Has a 1 5/8" max spring diameter)

Description	Jobber	Order No.
Standard Duty 1.000"-1.875" (25.4-47.6mm) Range	\$13.99	CF-44
Heavy Duty (non-adjustable)	29.99	CF-44HD

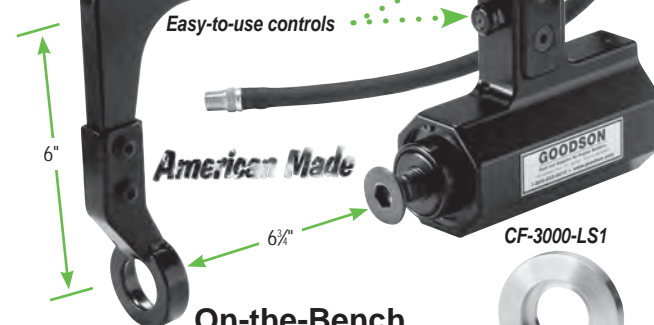

On-the-Bench Pneumatic Spring Compressor

- Handles springs up to 1500 lbs. at 90 PSI!
- Standard heavy-duty jaw fits springs up to 1.600" diameter
- Optional jaw fits springs to 1.740" diameter
- Features a dual stage cylinder that produces more force each time the control is pressed
- **Guaranteed to a maximum of 90 psi/620.5 kPa pressure**

Description	Jobber	Order No
Hi-Perf. Spring Compressor with 1.600" ID Jaw	\$1349.99	CF-3000B
Replacement Standard Jaw, 1.600" ID	123.99	CF-3002
Adaptor Jaw, 1.740"/44.2mm ID	123.99	CF-3003
LS1 Series Jaw Adaptor (1.750 OD) use with CF-3003	36.99	CF-3000-LS1
Rebuild Seal Kit (includes Intake Button Return Spring)	49.99	CF-3000SK
Replacement Intake Button Return Spring	9.99	CF-3004
Intake Trigger Assembly	51.99	CF-20004A
Exhaust Trigger Assembly	49.99	CF-20004B



"You'll always get fast, reliable service from Goodson, even on international orders. We'll do whatever it takes to make sure you get your shop supplies as quickly and easily as possible - anywhere in the world."
- Kim, Goodson Customer Service Manager, 36 years of service

CYLINDER HEAD
REBUILDING

CLEANING,
ASSEMBLY & SAFETY

SHORT BLOCK
REBUILDING

CRANKSHAFT/
FLYWHEEL GRINDING

MISCELLANEOUS
TOOLS & SUPPLIES

BRAKE SERVICE
TOOLING

MEASURING
TOOLS

V-TWIN & METRIC
HARD PARTS

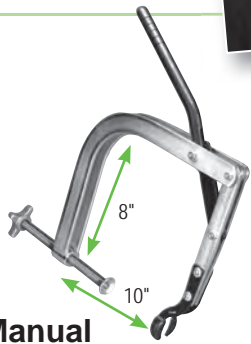

Manual Valve Spring Compressor

- Weighs only 6 lbs
- High leverage allows for easy, one-hand operation
- Covers a range from 10" high to 8" deep
- Works with most L-head and valve-in-head engines
- Fits truck & tractor engines
- Jaws adjust for small, medium and large springs

Description	Jobber	Order No.
Spring	\$92.99	CF-140
Compressor		
Replacement	13.99	CF-44
Jaw Set		
HD Replacement	29.99	CF-44HD
Jaw Set		

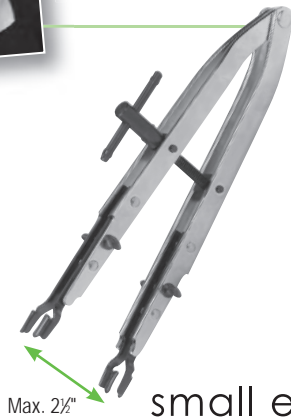

small engine powersports

Manual Valve Spring Compressor

- Compress **only** the spring for fast and easy keeper removal
- Fully adjustable steel jaws have maximum opening of 2 1/2" (63.5mm)
- For springs 1/2" (12.7mm) to 1 1/8" (28.6mm) in diameter
- Cadmium finished spring steel construction
- Order No. **CF-131** Jobber \$18.99

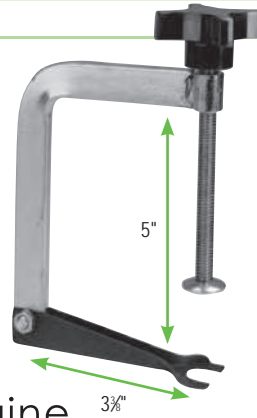

Manual Valve Spring Compressor For Small Engines

- Steel construction
- 20# max. spring pressure
- Once you lock the compressor in position, your hands are free to work
- Includes 2 jaw sets - small, for springs up to 7/8" (22.2mm) and large, for springs up to 1 1/16" (27.0mm)
- Order No. **CF-600** Jobber \$23.99

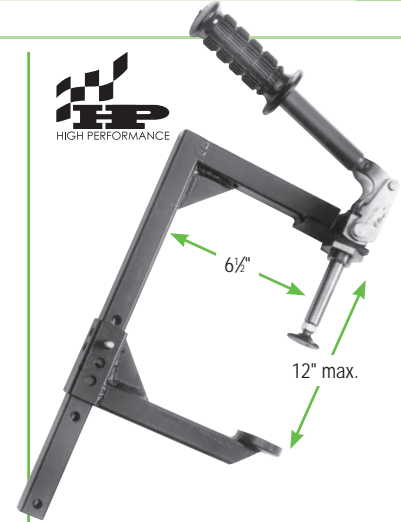

Manual Valve Spring Compressors

- Handle valve springs from a range of applications
- Welded, gusseted all-steel construction takes plenty of abuse
- Plenty of leverage to compress valve springs
- Order No. **CF-1500** Jobber \$244.99



Keeper Installation Tools

- Spring-loaded plunger
- For single & multi-groove keepers
- Reaches keeper grooves located farther from the valve tip • Ideal for use with **CF-500** (p. 39) and **PSB-5000** (p. 38)

Best Keeper Tool on the Market!

Size	Jobber	Order No.
5mm / .2031"	\$79.99	VKI-5
6mm / .2344"	79.99	VKI-6
7mm / .2812"	79.99	VKI-7
8mm / .3125"	79.99	VKI-8
Replacement Rubber Sleeve	6.99	VKI-56

Valve Spring Compressor Adaptor

- Fit seat and guide machines or drill press
- Puts collet or drill press chuck behind adaptor
- Allows more room to remove or re-install valve keepers and associated components
- Fits 1/2" collet or Jacobs chuck (not included)

OD (mm)	Reach (mm)	Jobber	Order No.
3/4" (19.1)	3 3/4" (95.3)	\$36.99	CF-6
1 3/16" (20.6)	3 3/4" (95.3)	36.99	CF-8
1" (25.4)	3 3/4" (95.3)	39.99	CF-10
1 1/4" (31.7)	3 3/4" (95.3)	44.99	CF-12
1 1/2" (38.1)	3 3/4" (95.3)	44.99	CF-15



Small OHV Engine Keeper Removal & Installation Tool

- Easy to use - Uses your own body weight as leverage
- Works with 3.5mm to 5.5mm single groove valves only
- Complete set includes a remover with powerful magnet to hold the keepers in place after removal, universal installer and two non-slip valve chamber pads

Description	Jobber	Order No.
Keeper Removal Installation Tool	\$79.99	VKI-35
Keeper Magnet - 6 1/2" holder with .170" dia. Earth magnets	15.99	VKM-17



Adaptors for Deeply Recessed Springs

- Open top design gives easy access to keepers
- Durable, non-marring material
- Fit on Split-Jaw Spring Adaptors such as our **CF-44** (p. 39)



Description	OD	Height	Jobber	Order No.
Small Metal Adaptor	26mm	4" (101.6mm)	\$28.99	CF-32
Medium Nylon Adaptor	27mm	3" (76.2mm)	28.99	CF-24-G
Large Nylon Adaptor	32mm	3" (76.2mm)	28.99	CF-25-G

Valve Spring Compressors

CYLINDER HEAD REBUILDING
CLEANING, ASSEMBLY & SAFETY
SHORT BLOCK REBUILDING
CRANKSHAFT/ FLYWHEEL GRINDING
MISCELLANEOUS TOOLS & SUPPLIES
BRAKE SERVICE TOOLING
MEASURING TOOLS
V-TWIN & METRIC HARD PARTS

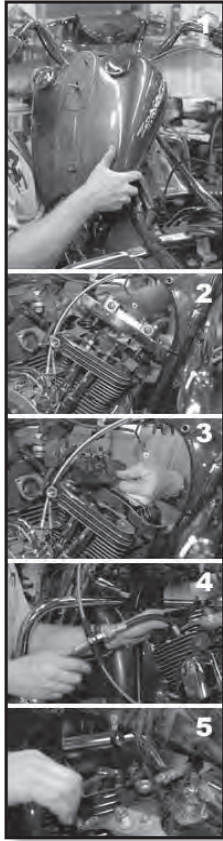

V-Twin On-the-Engine Valve Spring Compressor

Replace broken valve springs, install high performance valve springs, remove and replace valve guide seals all without disassembling the bike. Just remove the gas tank and get to work. Use on Sportster, Evolution, Twin-Cam and most aftermarket V-Twins. Kit includes valve spring compressor, adaptor for compressing beehive springs, valve seal driver/installer and head pressurizing hose.

Order No. **CF-HDIF**
Jobber \$164.99



Visit the Goodson Blog for more information on using this tool. Scan the code for a link.

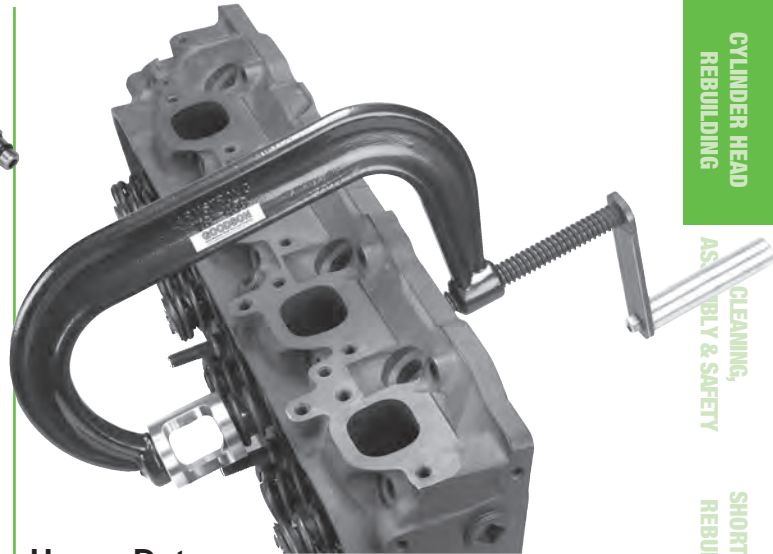

Heavy Duty Manual Valve Spring Compressor

- Drop forged steel frame
- Open receiver design allows for quick access to keepers
- Accommodates springs up to 1³/₄" diameter
- 8¹/₂" throat • 6" deep
- Compresses springs up to 1000 pounds

Description	Jobber	Order No.
Manual Valve Spring Compressor	\$279.99	CF-1300
Small Receiver (OD: 1.625", ID: 1", Height: 2.156")	79.99	CF-1300SF
Large Receiver (OD: 2.0", ID: 1.197", Height: 2.25")	89.99	CF-1300LF



Standard Valve Spring Adaptors

- For threaded shaft spring compressors
- Thumb screw adjustment
- Single locking screw secures jaw to frame

Adjustment Range	Jobber	Order No.
.875" - 1.875" (22.2-47.6mm)	\$19.99	CF-21A-G
1.00" - 2.000" (25.4-50.8mm)	27.99	CF-22C-G
Replacement Thumb Screw	1.99	CF-700-2-G



Pneumatic Valve Spring Compressor Rebuild Kit

- For pneumatic spring compressors with threaded shaft such as Plews, Clark Feather, etc.
- Includes seals, valves, springs and o-rings
- Order No. **CF-700-RK** Jobber \$69.99

Heavy Duty Valve Spring Adaptors

- Heavy duty jaws are not adjustable

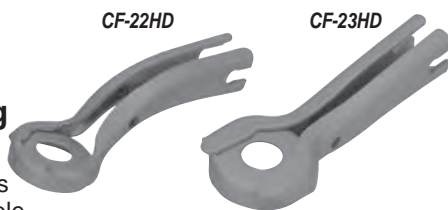

Spring Size Range	Jobber	Order No.
1.00" - 2.000" (25.4-50.8mm)	\$31.99	CF-22HD
1.50" - 2.500" (38.1-63.5mm)	29.99	CF-23HD



Keeper Magnet

- 6⁵/₁₆" long holder fits easily into deep bores
- Powerful .170" diameter earth magnet
- Order No. **VKM-17** Jobber \$15.99



Keeper-Keeper

- Screws tightly closed to hold keepers securely
- 1/4" holes
- Ideal for tumbling keepers
- Solvent resistant PVC
- Order No. **VK-15** Jobber \$15.99



"Our staff of ASE-Certified Techxperts® can help you solve problems fast! Call with questions about product applications, machining precision, longer tool life, improving efficiency, cost savings or any other technical topic. We're here to help you!"

- Erik, Goodson Tech Support Manager, 19 years of service

CYLINDER HEAD
REBUILDING

CLEANING,
ASSEMBLY & SAFETY

SHORT BLOCK
REBUILDING

CRANKSHAFT/
FLYWHEEL GRINDING

MISCELLANEOUS
TOOLS & SUPPLIES

BRAKE SERVICE
TOOLING

MEASURING
TOOLS

V-TWIN & METRIC
HARD PARTS

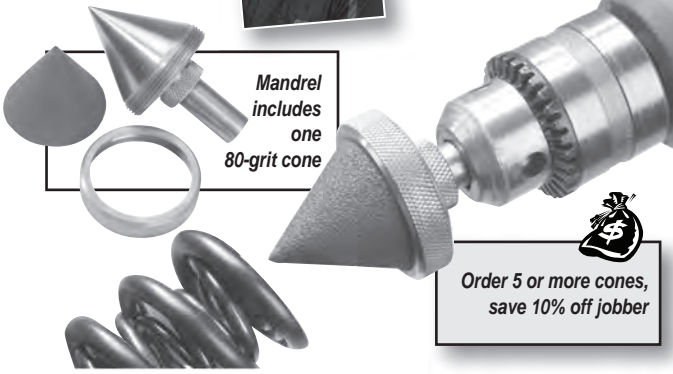

Mandrel includes one 80-grit cone

Order 5 or more cones, save 10% off jobber

Small Chamfering Cones & Mandrels Make Deburring and Chamfering Easy In Tight Spaces

These mandrels are available in two diameters – 3/4" and 1 1/2" diameters with a 1/2" shank to fit most portable drills. The small diameter fits easily into tight spaces such as Beehive Valve Springs (see page 127) or bolt holes. The mandrel is designed to support a 60° abrasive cone which is held securely by the retaining ring. One 80-grit cone is included with initial purchase.

Description	Jobber	Order No.
3/4" Dia. Mandrel	\$59.99	CC-34
3/4" Dia. Abrasive Cones	80 grit	3.99 CC-35
	120 grit	3.99 CC-36
1 1/2" Dia. Mandrel	\$62.99	CC-60
1 1/2" Dia. Abrasive Cones	80 grit	4.99 CC-61
	120 grit	4.99 CC-62

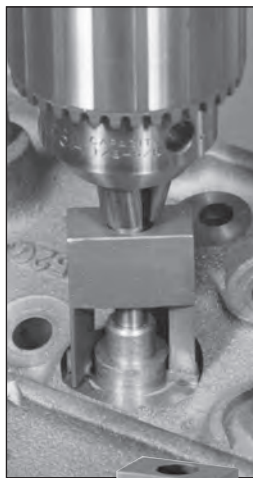

3-D Fast Cut™ Adjustable Spring Pad Cutters on page 10



Valve Spring Seat Cutters

- Resize valve spring seats to maintain spring-to-valve concentricity or use to enlarge seats for over-size dual springs
- Requires special pilot – see chart below

Carbide Tipped Cutter Bodies (use VP pilots below)

OD	ID	Jobber	Order No.
1.320"	.630"	\$92.99	VSS-1320
1.350"	.625"	92.99	VSS-1350
1.500"	.625"	92.99	VSS-1500
1.550"	.625"	92.99	VSS-1550
1.625"	.625"	92.99	VSS-1625
1.680"	.750"	92.99	VSS-1680HD
1.750"	.625"	92.99	VSS-1750

Hardened & Ground Pilots

Guide ID	Jobber	Order No.
5/32"	7.0	\$31.99 VP-7MM
3/16"	7.9	31.99 VP-312
11/32"	8.7	31.99 VP-343
3/8"	9.5	31.99 VP-375

tech tips

from the Techxperts™

You must use these pilots with the VSS and VSC cutters. The flat sides are necessary for a proper fit.

Universal Gel Lube

- Sprays on as a liquid and forms into a gel within seconds
- Penetrating formula blends freely with motor oil
- Multiple uses, including cams, lifters, rocker arms, bearings, pistons/wrist pins, cylinders, etc.
- Provides lubrication for engines subjected to prolonged storage before initial start-up
- Aerosol*
- Order No. **GL-8U** Jobber \$18.99



*Hazardous Goods Fees Will Apply if Shipped By Air



8 Piece Valve Train Checking Spring Set

- 1.250" OD
- Spring Steel construction
- Essential for high-performance engine building and engine blueprinting
- Maintain a positive valve train position while checking valve to piston clearance
- Order No. **VTS-8** Jobber \$14.99



Buy the Kit and SAVE!

Dial Indicated Valve Stem Height Gauges

- 5 sizes to choose from
- Small diameter extended measuring body allows extra height for dial indicator clearance
- Use with our large-faced Dial Indicator to check valve tip height



Description	Jobber	Order No.	Incl.	
Valve Stem Height Gauge Kit w/Stand	\$199.99	VSH-KIT	▼	
Dial Indicator (2" travel, .001" graduations)	67.99	MDI-2	x	
Dial Indicator (1" travel, .001" graduations)	28.99	EDI-1		
Measuring Bodies	OD	ID	OAL	
	.750"	.625"	3.830"	\$41.99 VSH-205 x
	.900"	.770"	2.840"	41.99 VSH-203 x
	.900"	.770"	3.840"	41.99 VSH-204 x
	1.060"	.812"	2.840"	41.99 VSH-201 x
	1.250"	1.090"	3.300"	41.99 VSH-202 x
Tool Stand	44.99	TS-5	x	
1" Checking Standard	11.99	MCS-1		

More dial indicators on page 121

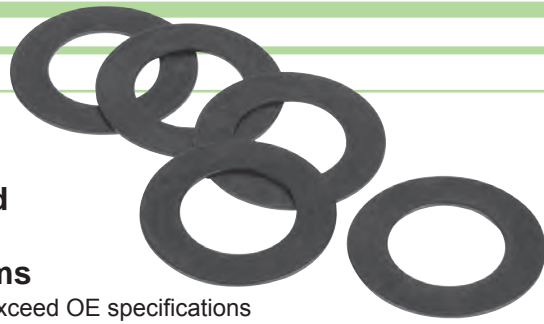

Non-Serrated Valve Spring Booster Shims

- Shims meet or exceed OE specifications
- Made of prime quality cold rolled steel
- Support valve springs better than serrated shims • Won't compress
- Maintains pressure and protects head from spring abrasion
- Non-serrated shims won't damage spring pad area on aluminum heads or cause lateral loads or harmonics

Special Orders are available. Call 1-800-533-8010 to inquire.

Size		50 count High Performance			100 count		
OD	ID	.060"	.030"	.015"	.060"	.030"	.015"
1.000"	0.688"				A-101	B-101	C-101
	0.765"				A-104	B-104	
1.100"	0.719"					B-106	
	0.875"				A-105	B-105	
1.250"	0.625"	A-107-HP	B-107-HP	C-107-HP	A-107	B-107	C-107
	0.812"	A-203-HP	B-203-HP	C-203-HP	A-203	B-203	C-203
	0.875"				A-201	B-201	
1.360"	1.000"	A-102-HP	B-102-HP	C-102-HP	A-102	B-102	
1.375"	0.765"	A-301-HP	B-301-HP	C-301-HP		B-301	
1.437"	0.785"	A-305-HP	B-305-HP	C-305-HP			
1.438"	0.645"	A-306-HP	B-306-HP	C-306-HP			
1.480"	0.703"	A-303-HP	B-303-HP	C-303-HP	A-303	B-303	
1.500"	0.645"	A-306S-HP	B-306S-HP	C-306S-HP			
	1.031"	A-103-HP	B-103-HP	C-103-HP	A-103	B-103	
1.634"	0.643"	A-601-HP	B-601-HP	C-601-HP			
Jobber		\$19.99	\$19.99	\$19.99	\$19.99	\$19.99	\$19.99



Magnetic Head Bolt Washer & Valve Spring Shim Removal Tools

- Hollow design allows easy access over studs or head castings
- Powerful earth magnets grab firmly, letting you lift the washer or shim easily

Description	Jobber	Order No.	Incl.
Magnetic Remover Set	\$109.99	MWR-SET	▼
Washer Removers	ID	OD	
	0.250"	0.625"	32.99 MWR-14 x
	0.500"	0.865"	32.99 MWR-12 x
	0.450"	0.812"	32.99 MWR-716 x
Shim Remover	0.708"	1.355"	36.99 MVS-2 x

No More Guesswork... Measure CCs Accurately!

Cylinder Head CC-ing Equipment

- Use glass buret with alcohol or solvent
- Positive on/off fluid control valve
- Clear acrylic plate lets you see when the combustion chamber is full
- Mix Measuring Concentrate with water to make 1 gallon

Description	Jobber	Order No.	Incl.
CC-Measurement Kit	\$169.99	CCB-KIT	▼
100cc Glass Buret	102.99	CCB-100	x
5" x 5" x 3/8" Acrylic Plate	11.99	GCB-3	x
Buret Cleaning Brush - 35 1/2" OAL	9.99	GCB-BRUSH	x
Buret Stand	18.99	GCB-1	x
Buret Clamp	18.99	GCB-2	x
Funnel	10.99	CCB-FUNNEL	x
Measuring Liquid Concentrate (Yields 1 Gal.)	14.99	GCB-LIQUID	
4" Precision Cylinder Head Level	174.99	LEV-4	
Replacement Vial for 4" level	102.99	VGL-101	
100cc Glass Beaker	41.99	GC-100	
Universal Cylinder Head Holders (pair)	139.99	HH-200	



Clear acrylic plate lets you see when the chamber is full



Positive fluid control

100cc Glass Buret allows use with alcohol or solvent

Clamp gives you ability to fully adjust the height of the buret in relation to your cylinder head

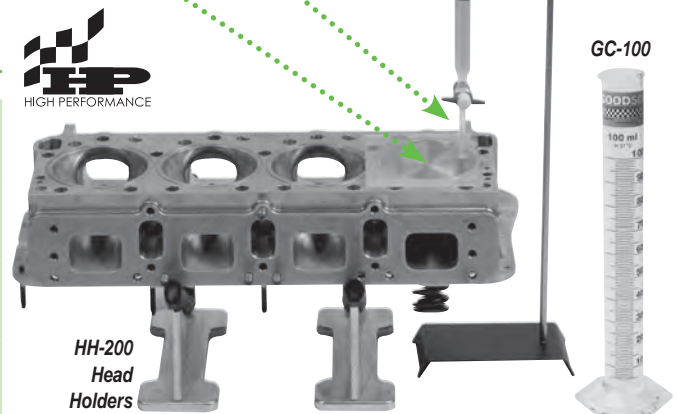

HH-200 Head Holders

GC-100

CYLINDER HEAD REBUILDING
CLEANING, ASSEMBLY & SAFETY
SHORT BLOCK REBUILDING
FLYWHEEL GRINDING
CRANKSHAFT/ FLYWHEEL GRINDING
MISCELLANEOUS TOOLS & SUPPLIES
BRAKE SERVICE TOOLING
MEASURING TOOLS
V-TWIN & METRIC HARD PARTS



"We work hard to earn your business; every day, every order. You can count on Goodson to be your most reliable and friendly source for shop supplies."

- Richard, Goodson Customer Service - 20 years of service

resharpening available

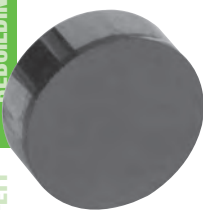

PCD Inserts for Aluminum

- A must for shops committed to meeting today's strict surface finish requirements
- Fits machines with 3/8" and 1/2" CBN holder
- 1/2" diameter inserts require shim (included)
- Use with Resurfacing Spray (HPS-16) for best results (see page 45)

Diameter	Thickness	Sided	Jobber	Order No.
3/8" (9.53mm)	1/8"	Single	\$185.99	PCDS-375
1/2" (9.53mm)	1/8"	Single	229.99	2379264
1/2" (12.7mm)	3/16"	Single	195.99	PCDS-500
1/2" (12.7mm)	3/16"	Single	219.99	2379265
1/2" (12.7mm)	3/16"	Single w/screw hole	199.99	2X6145

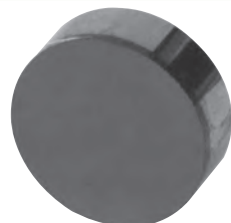

CBN Cutter Inserts For Cast Iron

- Faster and cleaner than segments and wheels

Titanium-Nitride Coated			Goodson		Uncoated Radiac	
Dia.	Thick.	Sided	Jobber	Order No.	Jobber	Order No.
3/8"	1/8"	Double	\$185.99	CBN-375D	-----	-----
	3/16"	Single	164.99	CBN-375S	-----	-----
1/2"	1/8"	Double	236.99	CBN-500D*	\$204.99	2X5299
	3/16"	Single	257.99	CBN-500S	219.99	2359233
	3/16"	Solid	-----	-----	259.99	2359234
	3/16"	Single Sided with Screw Hole	-----	-----	199.99	2X6144
	3/16"	Special Edge Prep for Diesel	-----	-----	209.99	2379268

Sharp Uncoated

3/8"	1/8"	Single	\$144.99	CBNS-38	-----	-----
1/2"	3/16"	Single	173.99	CBNS-12	-----	-----
1/16"	Thick Carbide Shim*		22.99	CBN-500SHIM	-----	-----

*Shim required on DCM machine

resharpening available

CBN Resharpening Service

Send your CBNs to Goodson to have them sharpened

Description	Jobber ea.	Order No.
Single Sided CBN Resharpening	\$49.99	RESHARP-CBNS
Double Sided CBN Resharpening	59.99	RESHARP-CBND

resharpening available

Enlarged for clarity



Super Abrasive For Cast Iron Diesel Heads

- Designed for cast diesel heads with hardened pre-cups • Won't chip
- Fits all overhead surfacers with 1/2" diameter insert capacity
- Will NOT work on standard cast heads
- .500" (12.7mm) diameter • .125" (3.2mm) thick
- Order No. DRD-500 Jobber \$355.99

*NOTE: A 3/16" thick carbide shim must be used with DRD-500 on DCM machines
• Order No. CBN-500SHIM Jobber \$22.99

tech tips

from the techxperts™

Confirm level calibration before every use.



2-Way Resurfacing Set-up Level

- Top-quality CNC machined T-6 aluminum frame with hardened & ground tool-steel contact pads
- Level both directions at once • Includes 6" precision vials (LEV-8-1) • Weighs just 2 lbs.
- Order No. LEV-TR Jobber \$419.99

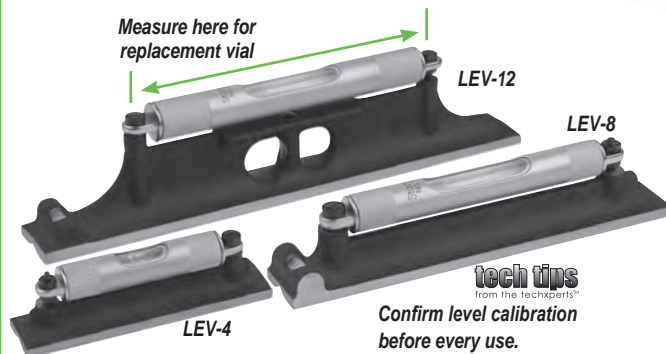

tech tips

Confirm level calibration before every use.

Precision Levels and Vials

- Graduated vials with satin-chromed, brass protective covers that rotate to close tightly
- Base castings are seasoned, then precision machined and finished on a bearing surface • Replaceable vials
- Adjustable for precise calibration
- 1 division equals .0005" per inch
- Fits pilots from 6mm to .437"



VGL-100 (pilot sold separately)

Description	Jobber	Order No.	Replacement Vial
4" Valve Guide Level (3" vial)	\$199.99	VGL-100	\$102.99 VGL-101
4" Level (3" vial - nominal)	174.99	LEV-4	102.99 VGL-101
8" Level (6" vial - nominal)	249.99	LEV-8	149.99 LEV-8-1
12" Level (8" vial - nominal)	349.99	LEV-12	179.99 LEV-12-1

Import / Metric Cylinder Head Stud Stretchers

- Save time, don't remove the studs from a head for resurfacing • Put stud stretchers on two studs and leave the rest • Sold in pairs

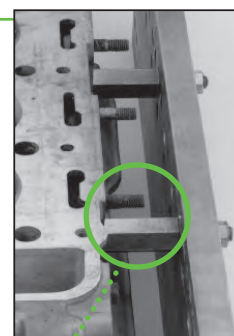

Length	Thread	Jobber	Order No.
3"	8mm x 1.25	\$53.99	SS-20
3 3/4"	8mm x 1.25	53.99	SS-30
3 3/4"	10mm x 1.25	53.99	SS-40



Cylinder Head Resurfacing

Buy 3 or 4 belts,
save 10% off jobber

Buy 5 or more,
save 15% off jobber

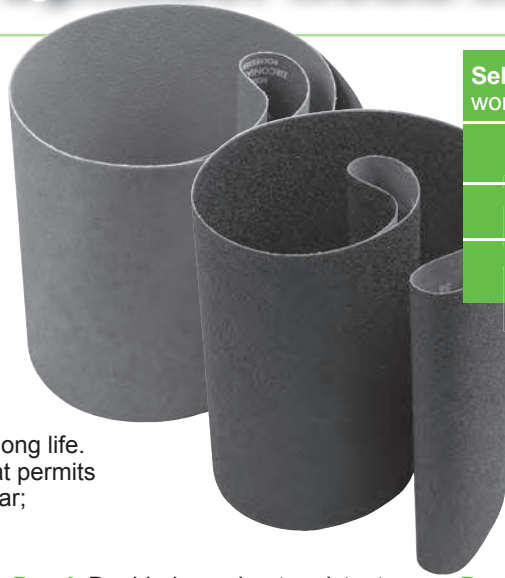

Selection Guide: which abrasive works best on what materials...

ALUMINUM	CAST IRON	STEEL	Zirconia-Alumina (40g)
			Silicon-Carbide (40g)
			Silicon-Carbide (80g)

Need a Different Size or Grit?

Goodson can make the size you need. Specify grit, grain and size and we'll take it from there. Call 1-800-533-8010 for info!

Cylinder Head Resurfacing Belts

A belt has three important parts: abrasive, bond and backing. Goodson belts are made for top performance and long life. Our belts also feature a unique splice that permits use in both directions for even longer wear; when worn one way, turn belt around to resurface more heads.

Abrasive: Match the abrasive to the workpiece (aluminum, cast iron or steel) and to your machine for the longest belt life.

Bond: Double-layer, heat-resistant resin holds abrasive firmly. Bond is so strong that grains wear out instead of loosening.

Backing: Waterproof, poly-back belt won't tear or fray. It's the toughest backing of any resurfacing belt.

Need a Special Grit or Size? Contact Goodson Today!

Silicon-Carbide 40-grit:

- Good-quality • Black
 - Primarily for cast iron but can resurface aluminum if extra care is used
 - Down-pressure optional
- 60 Grit Available**
Most Popular Size: 14"x86
Order No. **SGS-14-86-60**
Jobber \$44.99

Silicon-Carbide 80-grit:

- Good-quality • Black
- Designed especially to resurface aluminum
- Down-pressure not recommended

Zirconia-Alumina 40-grit:

- Better-quality
- Blue
- Grains fracture under pressure to stay sharp
- For cast iron or steel
- Down-pressure recommended

Zirconia Alumina With Grind Aid - 40-grit:

- Premium-quality belt with pre-applied Grind Aid
- Blue/Green
- Excels on severe applications
- Grains fracture under pressure to stay sharp
- For stainless steel, alloy and aluminum

Belt Size	Jobber	Order No.	Jobber	Order No.	Jobber	Order No.	Jobber	Order No.
10" x 103"	\$43.99	SGS-10-103	\$39.99	SGA-10-103	\$51.99	SGB-10-103	\$59.99	SGZ-10-103
11 1/2" x 76"	34.99	SGS-11-76	37.99	SGA-11-76	39.99	SGB-11-76	62.99	SGZ-11-76
11 1/2" x 79"	36.99	SGS-11-79	37.99	SGA-11-79	47.99	SGB-11-79	64.99	SGZ-11-79
11 1/2" x 89"	37.99	SGS-11-89	44.99	SGA-11-89	53.99	SGB-11-89	67.99	SGZ-11-89
11 1/2" x 91"	39.99	SGS-11-91	47.99	SGA-11-91	56.99	SGB-11-91	69.99	SGZ-11-91
11 1/2" x 101"	39.99	SGS-11-101	47.99	SGA-11-101	59.99	SGB-11-101	71.99	SGZ-11-101
14" x 86"	44.99	SGS-14-86	49.99	SGA-14-86	61.99	SGB-14-86	74.99	SGZ-14-86
14" x 103"	49.99	SGS-14-103	49.99	SGA-14-103	72.99	SGB-14-103	77.99	SGZ-14-103
14" x 107 1/2"	49.99	SGS-14-107	52.99	SGA-14-107	74.99	SGB-14-107	79.99	SGZ-14-107
14" x 113 1/2"	59.99	SGS-14-113	59.99	SGA-14-113	81.99	SGB-14-113	81.99	SGZ-14-113
15" x 127 1/2"	64.99	SGS-15-127	67.99	SGA-15-127	99.99	SGB-15-127	89.99	SGZ-15-127

Colors may vary due to manufacturing process. Guaranteed for 1 year from original purchase date.

Belt Resurfacer Coolant

- Semi-synthetic
- Rust-inhibiting
- For ALL belt resurfacers with a coolant sump
- Dilute 30 parts water:1 part coolant



Size	Jobber	Order No.
1 Gallon (3.79L)	\$ 47.99	SGB-10
5 Gallons (18.39L)	229.99	SGB-50

High Performance Resurfacing Spray

- Prolongs cutter life
- Enhances surface finish
- Refreshing scent
- Aerosol*
- Order No. **HPS-16**



Jobber \$12.99
*Hazardous Goods Fees Apply When Shipped By Air

Save 10% on 10!
Order 10 or more and SAVE 10% off jobber

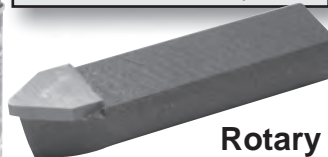

Rotary Broach Tool Bit For Van Norman 530, 570 & VM-2000

- Tool Bits sold individually
 - Order No. **VN-65C**
- Jobber \$19.99

Enlarged for clarity

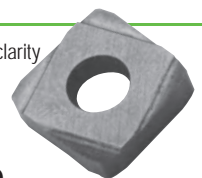

Carbide Cutter Replacement Tips For Storm Vulcan Broach Style Surfacer

- Fits Storm Mill 85, 85B, 85BE, 85C, 85N and 280
 - Order No. **SV-85BE**
- Jobber \$29.99

CYLINDER HEAD REBUILDING
CLEANING, ASSEMBLY & SAFETY
SHORT BLOCK REBUILDING
GRANDSHAFTE/FLYWHEEL GRINDING
MISCELLANEOUS TOOLS & SUPPLIES
BRAKE SERVICE TOOLING
MEASURING TOOLS
V-TWIN & METRIC HARD PARTS



"We are committed to maintaining your privacy. Information about you and your business is never sold, rented or given to anyone outside of our company."

- Sue, Goodson Database Manager - 34 years of service

SAVE!

Buy a complete set of 8 or more segments and take 10% off jobber!



tech tips

from the techxperts™

4 Keys to Resurfacing Aluminum Heads

1 - Choose the correct abrasive

Use a speckled wheel segment to grind aluminum heads.

2 - Lubricate, Lubricate, Lubricate

Put a light coat of **Grind Aid (GRA-10)** on the abrasive to reduce aluminum build up. Speed up the travers and reduce the cut to .0005" to .0010" per pass.

3 - Dress for Success

Keep grains open by dressing often. Don't dress before the last pass, but be sure to apply Grind Aid liberally so the stone yields a finer surface finish.

4 - Keep heat build-up to a minimum

The greatest danger is heat build up that can cause scoring as aluminum transfers to the stone. Take shallow cuts and use plenty of lubrication to prevent this.

CYLINDER HEAD REBUILDING

CLEANING, ASSEMBLY & SAFETY

SHORT BLOCK REBUILDING

CRANKSHAFT/ FLYWHEEL GRINDING

MISCELLANEOUS TOOLS & SUPPLIES

BRAKE SERVICE TOOLING

MEASURING TOOLS

V-TWIN & METRIC HARD PARTS

Silicon-Carbide Abrasive

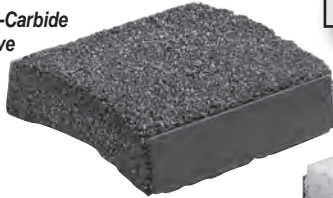

Aluminum Oxide Abrasive



Aluminum Oxide & Silicon-Carbide Abrasive

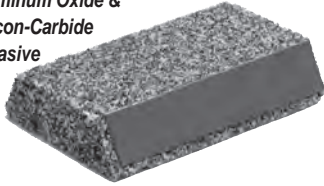

Aluminum Oxide Abrasive



Resurfacing Wheel Segments

Segments are available in a variety of compositions.

Match the abrasive to the material for best results and longest life. Order segments in 8, 10 or 12 piece sets.

Width	Thickness	Length	Application	Abrasive	Color	Jobber	Order No.
2.56"/65mm	0.98"/25mm	3.94"/100mm	Cast Iron & Aluminum	Silicon-Carbide	Black	\$19.99	GS-PBS
			Steel & Hardened Metals	Aluminum Oxide	White	19.99	GS-PBS-1
			Aluminum, Cast Iron, Hardened Iron & Steel	Aluminum Oxide and Silicon-Carbide	Speckled	19.99	GS-PBS-2
			Steel & Hardened Metals	Aluminum Oxide	Ruby	19.99	GS-PBS-3
For Peterson/Peterson Berco 1055 AWL, RSC950 (std.), SYP320, -360, -1000, -1300, RSC1200, -1550, RPYS1500 models. For Winona Van Norman SM-2000, SM-4000/5000, MG-4000, SM-6000C/6000A and MG-3000/3850 models. For Storm Vulcan RT7Y Late (Serial No. 103152 and up) and RT 17Y Late (Serial No. 128697 and up) models.							
3.13"/79mm	0.81"/21mm	3.13"/79mm	Cast Iron & Aluminum	Silicon-Carbide	Black	\$19.99	GS-SVS
			Aluminum, Cast Iron, Hardened Iron & Steel	Aluminum-Oxide and Silicon-Carbide	Speckled	19.99	GS-SVS-2
			Steel & Hardened Metals	Aluminum Oxide	Ruby	19.99	GS-SVS-3
For Peterson/Peterson Berco RG-32, RTY, RG-35, RG-300/900 models. For Storm Vulcan RT 7Y Early (Serial no. up to 103151) and RT 17Y Early (Serial no. up to 128696)							
1.97"/50mm	0.67"/17mm	3.62"/92mm	Cast Iron & Aluminum	Silicon-Carbide	Black	\$19.99	GS-RGS
For Peterson/Peterson Berco RG-32, RG-300/900 models.							
2.56"/65mm	0.79"/20mm	3.94"/100mm	Steel & Hardened Metals	Silicon-Carbide	Black	19.99	GS-KWS
			Aluminum, Cast Iron, Hardened Iron & Steel	Aluminum-Oxide and Silicon-Carbide	Speckled	19.99	GS-KWS-2
For Kwik-Way 858 and 862 models							

tech tips

from the techxperts™

To maintain proper cutting action Goodson strongly recommends that you replace your cylinder head resurfacing segments in full sets. See your user's manual for wheel diameter and number of segments required. Due to manufacturing process colors may vary.

Need help choosing the abrasive? Call the Goodson Techxperts™

Resurfacing Segments are guaranteed for 1 year from original purchase date

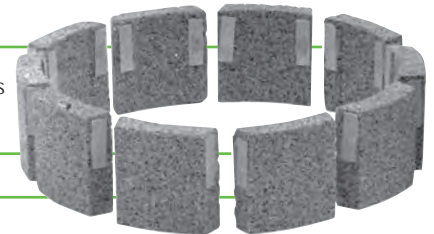

Grind Aid

- Cools and lubricates
- Stops premature grain fracturing
- Improves surface finish
- Handy twist tube with cover
- Reduces glazing and loading
- Essential when resurfacing aluminum heads
- Order No. **GRA-10** Jobber \$17.99



More storage bags on page 69

Cylinder Head Storage Bags

- 3 mil thickness
- 17"x44" / 43.2 cm x 111.8cm
- 100 per roll
- Order No. **BC-17** Jobber \$72.99

Rust Shield Aerosol*

- Choose between short and long term protection
- Spray on right after resurfacing
- Remove short term with soap & water and long term with solvent



Formula	Jobber	Order No.
Short Term	\$13.99	RS-16
Long Term	16.99	RS-16-OD

Order 6 or more cans, save 10% off jobber

*Hazardous Goods Fees Apply When Shipped By Air



Cylinder Head Resurfacing

The most complete resurfacing program in the industry ...

1. Consistent high quality abrasives

Each Goodson resurfer wheel is made to the highest standards of roundness, balance and strength. Extensive quality control, start-to-finish, lets us back our abrasives with our Iron-Clad Guarantee of total satisfaction.

2. Full inventory

Since we specialize in the distribution of abrasives to machine shops world wide we always carry an extensive inventory. Call Goodson, we have what you need on our shelves.

3. Same day shipping

We usually ship your order the same day that we receive it. Along with our huge inventory, our shipping speed ensures consistently faster delivery when you order from Goodson.



Surface Grinding Coolant

- Synthetic
- Water soluble
- Non-foaming
- Dilute 20:1

Size	Jobber	Order No.
1 Gallon / 3.78 L	\$ 29.99	SGC-10
5 Gallons / 18.93 L	134.99	SGC-50

Blanchard Cylinders

- Includes gasket pad for mounting onto a Blanchard Grinder
- Also ideal for resurfacing clutch plates
- Wheel measures 11" x 5" x 9"
- Tape wound for added safety
- Excellent grade for most grinding conditions and metals
- Order No. **U69755** Jobber \$169.99



Single-piece Resurfer Wheels

- Meet or exceed OE standards established for general purpose grinding applications
- Silicon-Carbide abrasive • Banding will wear off to expose more abrasive



GS-48



GS-954

Peterson				
Machine Model(s)	Size: dia. x height x face width	Grit	Jobber	Order No.
All 14" Dry Grinders	14" x 1½" x 4" Plate	36	\$439.99	GS-48
1054	16" x 2" x 2" Inserted Nut	16	429.99	GS-954



GS-545



GS-545B



GS-545BL

Kwik-Way				
Machine Model(s)	Size: dia. x height x face width	Grit	Jobber	Order No.
545,545H,855	12" x 3" x 1½" (Serrated) Plate	16	\$399.99	GS-545
545B,856,855-5,860	14" x 3" x 1½" (Serrated) Plate	24	534.99	GS-545B
545BL,860A, L & T	16" x 3" x 1½" (Serrated) Plate	24	609.99	GS-545BL
860A, L & T	16" x 3" x 1½" Plate	36	449.99	U422304

Grinding Wheels are guaranteed for 1 year from original purchase date

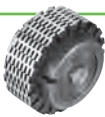

GS-10



GS-17A



FG-1165-G



FG-1070A-G



FG-1045-G



GS-14



GS-17

Grinding Wheel Dressers & Replacement Cutters

Diamond Dresser Tools are available on pages 106-107

Applications	Cutter Assemblies				Replacement Cutters						
	OD	W	Jobber	Order No.	Pieces	Washers	OD	ID	Thick	Jobber	Order No.
VN, Lempco, Storm RT-7Y, 17Y	2.500"	1.625"	\$116.99	GS-10	14 stars	1 w/locking tangs	2.50"	1.50"	.062"	\$23.99	GS-14
Peterson (12mm shaft)	2.375"	1.625"	90.99	GS-17A	8 stars	5	2.375"	1.50"	.093"		
						1 w/locking tangs	1.75"	1.50"	.060"	23.99	GS-17
WVN SM2000, 4000, 5000, 6000C, 6000A, MG3000, 3850	1.250"	.978"	29.99	FG-1165-G	7 stars	none	1.25"	.313"	.095"	7.99	FG-1161-G
Peterson & DCM	2.375"	2.262"	72.99	FG-1070A-G	5 stars		2.375"	1.132"	.1375"	16.99	FG-1070-G
Hand held			51.99	FG-1045-G	1 stone	none	1.50"	.313"	.625"	13.99	FG-1044-G

CYLINDER HEAD REBUILDING
CLEANING, ASSEMBLY & SAFETY
SHORT BLOCK REBUILDING
FLYWHEEL GRINDING
CRANKSHAFT/ TOOLS & SUPPLIES
MISCELLANEOUS
BRAKE SERVICE TOOLING
MEASURING TOOLS
V-TWIN & METRIC HARD PARTS



Goodson accepts major credit cards, debit cards, bank drafts and personal checks. Call us for more information."

- Bev, Goodson Accounting/Purchasing Manager - 36 years of service

**Goodson
exclusive**

CYLINDER HEAD
REBUILDING

CLEANING,
ASSEMBLY & SAFETY

SHORT BLOCK
REBUILDING

CRANKSHAFT/
FLYWHEEL GRINDING

MISCELLANEOUS
TOOLS & SUPPLIES

BRAKE SERVICE
TOOLING

MEASURING
TOOLS

V-TWIN & METRIC
HARD PARTS

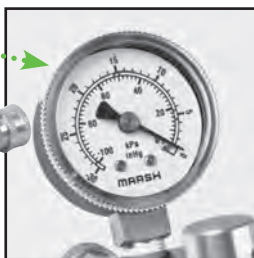
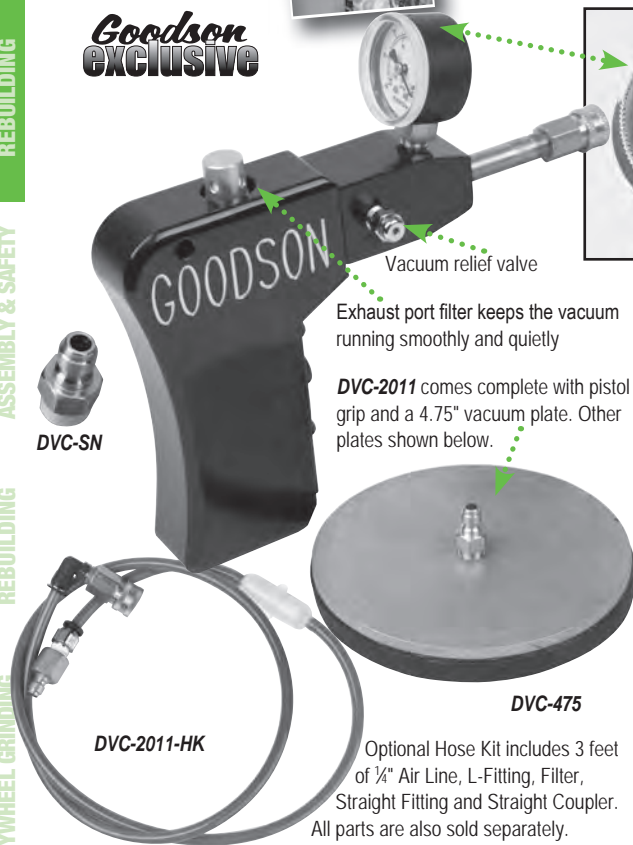

Pistol Grip Vacuum Tester

- Lightweight - only 1.9 lbs. without the plate
- Pulls and holds up to 24 PSI vacuum on as little as 90 PSI
- Quick coupling Robinair fittings
- Easy to reach controls for single-handed operation
- Hard-anodized billet aluminum
- Tester includes one 4.75" vacuum plate

Description	Jobber	Order No.
Pistol Grip Vacuum Tester Kit with 4.75" Vacuum Plate	\$599.99	DVC-2011
Optional Vacuum Plates		
Robinair Fitting Replacement Plate Set	\$154.99	DVC-7KIT
2.00" (50.8mm dia.)	21.99	DVC-2
3.00" (76.2mm dia.)	26.99	DVC-3
4.75" (120.7mm dia.)	26.99	DVC-475
6.00" (152.4mm dia.)	29.99	DVC-6
2"x3" (50.8x76.2mm)	22.99	DVC-23
3"x4" (76.2x101.6mm)	26.99	DVC-34
Plate Lube 8 oz. (236.6 mL)	5.99	DVC-PL
Parts & Accessories		
Pressure Gauge	\$39.99	DVC-GAUGE
Flexible Hose Kit w/3' Air Line (optional)	36.99	DVC-2011-HK
1/8" NPT "L" Fitting	4.99	CF-2003-L
1/8" NPT Female Coupling	12.99	LDP-AR-6
Inline Air Filter	11.99	DVC-FILTER
1/8" x 1/8" Straight Fitting	6.99	DVC-SF
Nipple Coupling	7.99	DVC-1N
Air Line	lin. ft. price 2.99	CF-2001-AL
Robinair Fitting	5.99	DVC-SN
1/8" NPT Male Coupling	15.99	DVC-1M

Vacuum relief valve
Exhaust port filter keeps the vacuum running smoothly and quietly

DVC-2011 comes complete with pistol grip and a 4.75" vacuum plate. Other plates shown below.

Optional Hose Kit includes 3 feet of 1/4" Air Line, L-Fitting, Filter, Straight Fitting and Straight Coupler. All parts are also sold separately.



Replacement Vacuum Tester Plates for Sioux™ 1630K

- Closed cell foam for an exceptional seal
- Replacement foam also available separately
- Several sizes to choose from or ask for a custom size
- Plate lube improves the seal for even better vacuum holding power

Sioux-Style Replacement Plates for the 1630K Tester			
Size	OE No.	Jobber	Order No.
2.00" (50.8mm dia.)	1630-2	\$31.99	SVT-2
3.00" (76.2mm dia.)	1630-3	33.99	SVT-3
4.75" (120.7mm dia.)	1630-4	31.99	SVT-475
6" (152.4mm dia.)	1630-6	34.99	SVT-6
2"x3" (50.8 x 76.2mm)		31.99	SVT-23
3"x4" (76.2 x 101.6mm)		32.99	SVT-34
Replacement Sioux-Style Fitting		13.99	DVC-SX
Accessories & Replacement Parts			
Description	Jobber	Order No.	
6 Pc. Replacement Foam Set - 1 of each size	\$34.99	FOAM-KIT	
Plate Lube - 8 oz. (236.6 mL)	5.99	DVC-PL	
Replacement Line Filter	11.99	DVC-FILTER	
Replacement Mat - 11" x 31" x 3/8"	41.99	DVC-1131	

Heavy Duty Manual Vacuum Tester

- A steady reading of 25" (63.5cm) indicates proper valve seating
- All metal construction
- 4 3/4" plate, fittings and plate lube included
- DVC Plates (above) will fit this tester

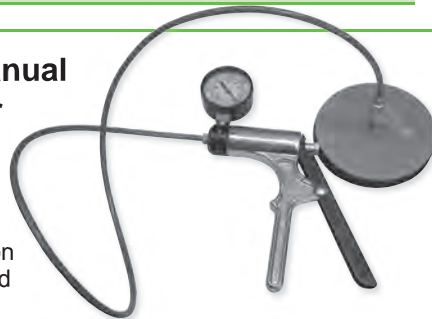

Description	Jobber	Order No.
Manual Vacuum Tester	\$169.99	DVC-101-HD
Replacement 4.75" Plate	26.99	DVC-475
Plate Lube - 8 oz. (236.6 mL)	5.99	DVC-PL

Vacuum Testing

tech tips
from the techxperts™

Vacuum testing is the fastest method for testing valve to seat integrity. Simply assemble your machined cylinder head and install the spark plugs. Use a reliable vacuum source producing approximately 24 lbs. HG on the vacuum gauge and a closed cell foam test plate with a through fitting to draw down or evacuate the combustion chamber.

Once you've reached 24 lbs. HG on the gauge and close the vacuum to the chamber. Watch the gauge for a drop in vacuum. It should hold steady confirming that you have achieved valve to seat mating.

Coat the face of your closed cell foam test plate with Plate Lube (DVC-PL) to condition the foam. This produces a soft, yielding material that will fill minor head surface blemishes or imperfections.

Dye Penetrant Crack Detection

Identify surface cracks in minutes!

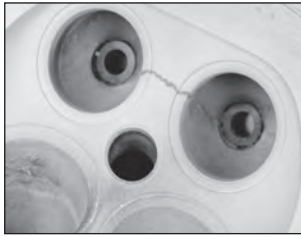

Alumni-Chek

- Find surface cracks on aluminum & cast iron without electricity or special lights
- Ideal for aluminum, but also works on brass, cast-iron, steel, carbide, and Stellite • Even the tiniest cracks show as bright red • Complete kit includes Cleaner, Penetrant, Developer and Shop Towels (also available separately)

Description	Jobber	Order No.	Incl.
Complete Kit	\$39.99	AC-KIT*	▼
Cleaner Aerosol	19.99	AC-1*	x
Penetrant Aerosol	19.99	AC-2*	x
Developer Aerosol	19.99	AC-3*	x
5 Towels	3.99	WST-5	x

Mix or match Cleaner, Penetrant & Developer to make a case of 12 and SAVE 10% OFF Jobber!

*Hazardous Goods Fees Apply When Shipped By Air



Oil Dye for Gasoline Engines

- Put into a running engine to find hidden leaks
- Check engines, transmissions and radiators IN the vehicle
- Use before disassembly to plan repairs
- Use after rebuilding to ensure satisfaction, or to find and fix warranty complaints
- Add dye to oil, coolant or fluid
- No pre-cleaning required
- Run vehicle briefly to distribute the dye
- Inspect with UV light
- Finds even the tiniest of leaks
- Order No. **GLO-GED** Jobber \$11.99



California Proposition 65

Proposition 65 requires businesses to provide warnings to Californians about significant exposures to chemicals that cause cancer, birth defects or other reproductive harm.

Due to recent regulatory changes in California, we must now warn you that many of the products commonly used to manufacture our products contain chemicals known to the state of California to cause cancer and reproductive harm.

⚠ WARNING: This product can expose you to chemicals including Toluene, Ethyl Benzene, Perchloroethylene/Tetrachloroethene/Tetrachloroethylene, Dichloromethane (Methylene Chloride) or Trichloroethylene which are known to the State of California to cause cancer or reproductive harm. For more information go to www.P65Warnings.ca.gov.

tech tips

from the techxperts™

- Step 1:** Spray cleaner evenly on the surface and allow it to dry completely.
- Step 2:** Spray on Penetrant. Allow to saturate for 5 minutes. Wipe off excess to avoid false readings.
- Step 3:** Spray on thin layers of developer to build up a uniform powdery film.
- Step 4:** Flaws and cracks will glow brightly when viewed under the black light (Applies only to Goodson Glow).



GOODSON Glow Crack Detection Sprays

- Easily detect surface cracks that could easily be missed with just visual inspection
- Cracks & flaws glow brightly under black light after treatment with Cleaner, Penetrant and Developer

Description	Jobber	Order No.
Goodson Glo Cleaner Aerosol	\$19.99	GLO-1*
Goodson Glo Penetrant Aerosol	24.99	GLO-2*
Goodson Glo Developer Aerosol	29.99	GLO-3*

Mix or match Cleaner, Penetrant & Developer to make a case of 12 and SAVE 10% OFF Jobber.

*Hazardous Goods Fees Apply When Shipped By Air



Crack Detection Powder & Oil Carrier

- For wet method crack detection
- Mix powder with oil carrier
- Use **GLO-300** Light (left) to view results

	Size	Jobber	Order No.
Powder	4 oz. / 113.4g	\$ 49.99	GCR-14A-4
	1 lb. / 453.6g	189.99	GCR-14A
Oil Carrier	5 Gallons / 18.93L	134.99	GCR-50



Magnetic Crack Detection Oil & Spray

- Oil impregnated with magnetic powder (**GCR-14A** or **GCR-14A-4**) to glow under black-light
- Low viscosity
- Flows easily into small cracks
- Oil clarity makes cracks easier to see

Description	Jobber	Order No.
Aerosol* 16 oz.	\$ 29.99	MFA-16*
5 Gallons /18.93L	157.99	MFA-50

*Hazardous Goods Fees Apply When Shipped By Air



CYLINDER HEAD REBUILDING
CLEANING, ASSEMBLY & SAFETY
SHORT BLOCK REBUILDING
FLYWHEEL GRINDING
CRANKSHAFT/ TOOLS & SUPPLIES
MISCELLANEOUS TOOLS & SUPPLIES
BRAKE SERVICE TOOLING
MEASURING TOOLS
V-TWIN & METRIC HARD PARTS

American Made

CYLINDER HEAD
REBUILDING

CLEANING,
ASSEMBLY & SAFETY

SHORT BLOCK
REBUILDING

CRANKSHAFT/
FLYWHEEL GRINDING

MISCELLANEOUS
TOOLS & SUPPLIES

BRAKE SERVICE
TOOLING

MEASURING
TOOLS

V-TWIN & METRIC
HARD PARTS

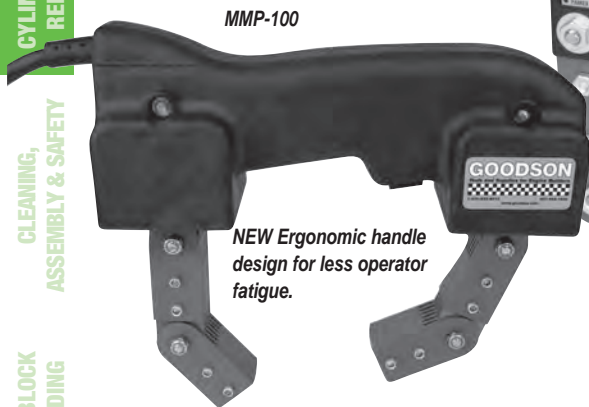

MMP-100

NEW Ergonomic handle design for less operator fatigue.

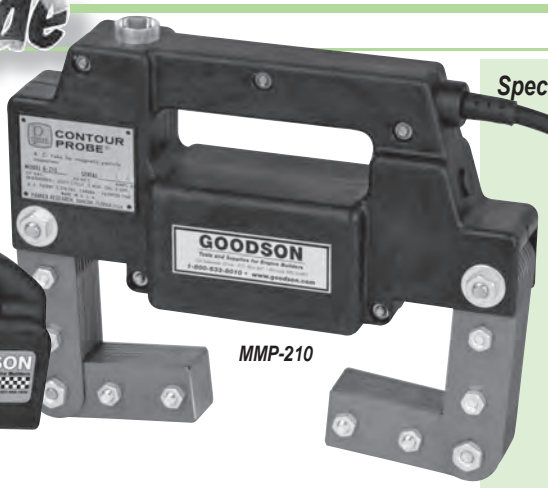

MMP-210

Articulating legs adjust to a wide range of angles, allowing you to test uneven surfaces with ease

Specifications



MMP-100 / MMP-100S
Physical: 7 3/8" x 9 1/4" x 2 1/8"
187 x 235 x 54mm
Max. Span: 12" (304.8mm)
across poles
Voltage: 115V (MMP-100)
230V (MMP-100S)
Line Current: 4 amp (MMP-100)
3 amp (MMP-100S)
Weight: 6.5 lb (2.95 kg)
Cord: 10' L, 3-wire



MMP-210 / MMP-210S
Physical: 10 1/2" x 11" x 2 3/4"
266 x 280 x 70mm
Max. Span: 18" (457mm) across poles
Voltage: 115V (MMP-210)
230V (MMP-210S)
Line Current: 8 amp (MMP-210)
3 amp (MMP-210S)
Weight: 13 lb (5.9 kg)
Cord: 10' L, 3-wire

Magnetic Crack Detection Units

- Articulating legs conform to virtually any surface configuration
- Designed for one-person operation • Lightweight • No transformer box to drag around • 230V units feature a pigtail on the cord • Easy to access switches • Full 1-Year Manufacturer's Warranty for Repair • 50% duty cycle (example: 2 minutes on, 2 minutes off) • Produce a strong AC magnetic field

Description	Jobber	Order No.
115V Electronic Crack Detector with 10# Pull	\$559.99	MMP-100
115V Heavy Duty Electronic Crack Detector with 22# Pull	689.99	MMP-210
230V Electronic Crack Detector with 10# Pull	559.99	MMP-100S
230V Heavy Duty Electronic Crack Detector with 22# Pull	689.99	MMP-210S

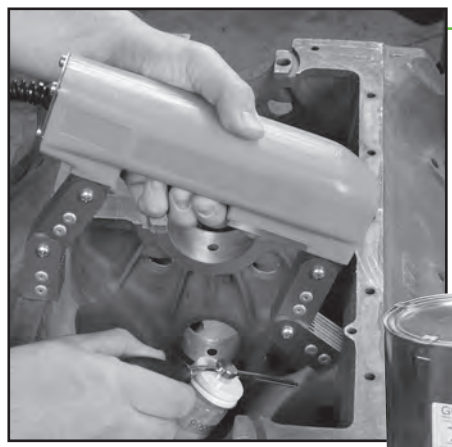

tech tips from the techxperts™

Let's talk about why we check for cracks in heads and blocks. The obvious reason is that you can't fix what you don't know is there. Cracks and pinholes in heads and blocks can lead to a loss of power in the engine, resulting in poor performance. That, unfortunately, is the best-case scenario. Cracks or pinholes can also lead to overheating and complete engine failure, not to mention dissatisfied customers returning again and again in search of that elusive leak.

My recommendation is when a customer brings in a head or a block for you to work on, before you even take the piece, ask him a few questions.

Read more on the Goodson Blog. Search for "Holes In Your Head ... Or The Fine Art Of Crack Detection"

American Made

Non-Fluorescent Magnetic Powder for Dry Method Particle Inspection

- Works with all dry magnets including Magnaflux® and Parker
- Store in a moisture free environment



Color/Size	1 lb.	5 lb.	25 lb.
White	WCD-100-G	WCD-500-G	WCD-2500-G
Yellow	WCD-101-G	WCD-501-G	WCD-2501-G
Red	WCD-103-G	WCD-503-G	WCD-2503-G
Jobber ea.	\$9.99	\$47.99	\$229.99

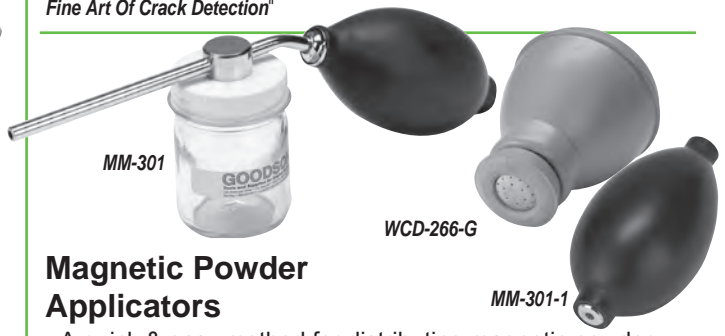

Magnetic Powder Applicators

- A quick & easy method for distributing magnetic powder

Description	Jobber	Order No.
Atomizer Assembly for small areas (1 oz.)	\$25.99	MM-301
Applicator Bulb for large areas	20.99	WCD-266-G
Replacement Bulb for Atomizer Jar	13.99	MM-301-1

... another satisfied customer

"Goodson's Fluorescent Magnetic Powder works great! Cracks glow bright yellow under black light. We find the fluorescent powder much more effective at picking up cracks than any powder we have used in 30 years of crack detection!"

- Steve's Machine Shop, Liberty, NY, Goodson customer since 1994

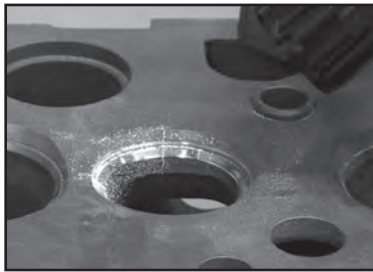

Green Fluorescent Magnetic Powder

- For dry magnetic inspection methods
- Makes crack detection easier
- Cracks glow bright yellow-green under ultraviolet light but can also be seen under normal lighting conditions

Quantity	Jobber	Order No.
1 lb.	\$19.99	FCP-107-G
5 lb.	89.99	FCP-507-G

tech tips from the techxperts™

Tips for Fast, Accurate Crack Detection

When using the dry magnetic crack detection method NEVER blast with media prior to testing. Blast media peens the surface and can move metal, possibly disguising the very cracks or flaws you are trying to identify.

For more quick tips visit the Goodson blog or scan the code at right.



American Made
Goodson exclusive

Magnetic Crack Inspection Kits

Goodson carries a variety of magnetic crack detection methods including this kit. We include heavy-duty 110V adjustable-leg magnetic yokes made right here in America. The complete kit also includes magnetic powder, atomizer and magnetic crack detection spray. All items are also available separately.



Description	Jobber	Order No.	Incl.
High Performance Fluorescent Crack Detection Kit	\$699.99	FCD-HP-KIT*	▼
115V Heavy Duty Electronic Crack Detector	679.99	MMP-210	x
Magnetic Powder Atomizer Assembly (1 oz. capacity)	25.99	MM-301	x
Magnetic Crack Detection Oil Spray*	29.99	MFA-16*	x
Fluorescent Magnetic Powder — 1 lb.	19.99	FCP-107-G	x

*Hazardous Goods Fees Apply When Shipped By Air



tech tips from the techxperts™

It is essential that you measure residual magnetism when using magnetic crack inspection. Magnetic fields are measured in gauss and the gauge used to measure it is a magnetic field indicator (MFI-10010 below).

To see if you have any residual magnetism in your components, simply hold the field indicator close to the part. If it doesn't read "0", you have magnetism.

Small Parts Demagnetizer

Don't jeopardize your engine work! Heat, friction and magnetic particle inspection can cause magnetism to build up in your engine components. If not removed, it will attract ferrous materials in engine lubrication and may cause premature engine failure. This easy to use table demagnetizer is a fast and easy way to ensure that all residual magnetism is eliminated from engine components. Use with the optional Magnetic Field Indicator (MFI-10010) to be sure all remaining magnetism has been fully eliminated.

Description	Jobber	Order No.
Small Parts Demagnetizer	\$97.29	SPD-46
Magnetic Field Indicator	69.99	MFI-10010

CYLINDER HEAD REBUILDING
CLEANING, ASSEMBLY & SAFETY
SHORT BLOCK REBUILDING
FLYWHEEL GRINDING
MISCELLANEOUS TOOLS & SUPPLIES
BRAKE SERVICE TOOLING
MEASURING TOOLS
V-TWIN & METRIC HARD PARTS



"At Goodson, we're always on the lookout for new or improved tools that make engine rebuilding easier. If you have a tool you think we'd be interested in, give us a call."

- Dave, Goodson National Sales Manager, 24 years of service

CYLINDER HEAD
REBUILDING

CLEANING,
ASSEMBLY & SAFETY

SHORT BLOCK
REBUILDING

CRANKSHAFT/
FLYWHEEL GRINDING

MISCELLANEOUS
TOOLS & SUPPLIES

BRAKE SERVICE
TOOLING

MEASURING
TOOLS

V-TWIN & METRIC
HARD PARTS

shown actual size



melted center reveals
overheating



Heat Tabs

- Provides visual evidence of engine overheating
- Special heat sensitive metal centers melt and fall out when engine exceeds the melting point of the tab
- 100 Heat Tabs per package
- Attach to heads with Heat Tab Adhesive (below)

Description	Melting Point	Jobber	Order No.
Round Heat Tabs	255-260° F / 124-127° C	\$44.99	RHT-100
Round Ironite Heat Tabs	255-260° F / 124-127° C	74.99	HT-100RD
Round Diesel Heat Tabs	225-235° F / 107-110° C	52.99	DHT-100
Heat Tab Adhesive (3 oz./88.7mL tube)		9.99	HTA-3

tech tips

from the techxperts™

Protect yourself from unjustified warranty claims with a simple Heat Tab

When you attach a heat tab to the engine it provides visual evidence that an engine has been overheated. A special heat sensitive metal has been formed into the center of the tab. When an engine reaches the tab's melting point, this metal will melt and flow out. This is a positive method of determining that a rebuilt engine has been heated beyond normal operating temperature, voiding the warranty. Attach a Heat Tab to the upper portion of the block or to the cylinder head casting with **HTA-3** Heat Tab Adhesive (above). **DO NOT** attach to manifolds or shielding.

Leak Detection Mat

- Commercial-grade Neoprene
- Resists petroleum products, abrasion, swelling, sunlight and aging
- Repair worn mats or make custom leak detection plates
- Measures 3' x 4' x 3/16" thick
- Order No. **LDP-34MAT** Jobber \$87.99



Seal-All™

- Seals pin holes, porosity and small cracks in heads & blocks
- Penetrates and seals
- Out-performs ceramics
- Bonds with existing rust & corrosion to prevent spread
- Heat at 175°-200°F (79.4°-93.3°C) for 4 hours to cure
- Not for use on assembled engines
- 32 oz. (46 mL)
- Order No. **CPS-32**
- Jobber \$72.99



Fluid Weld®

- For cast iron or aluminum heads and blocks
- Use as a sealant for threaded or press-fit parts like valve guides and seats, threaded crack repair plugs, replacement studs, etc.
- Seals small cracks • Non-toxic
- Non-flammable
- **NOT** for use on assembled engines
- Withstands temperatures to 3000°F



Size	Jobber	Order No.
2 oz. (59 mL)	\$ 46.99	FW-2
8.8 oz. (260 mL)	142.99	FW-88

All Weather Seal

- Seals intakes & head gasket leaks
- Seals cracks in cylinder heads & engine blocks
- Prevents anti-freeze from seeping through gaskets and hoses
- Lubricates water pump seals
- Mixes with all anti-freeze and coolant
- Works in less than 5 minutes
- Fast-acting, non-corrosive, non-clogging
- Can be used with coolant or anti-freeze
- 16 oz./455 mL • Order No. **AWS-16**
- Jobber \$19.99



For use in a
running engine!

Engine Seal Tabs Seal And Prevent Leaks In Any Cooling System

- Use in a running engine
- For water leaks in cylinder heads, blocks, radiators, water pumps, heater cores, manifolds, etc.
- 3 1/2 gram tablets treat up to a 9 quart cooling system
- 20 tabs per pack
- Order No. **EST-10** Jobber \$30.99



Threaded Crack Repair Plugs

- Iron • Tapered • Threaded plugs
- Cast to rigid specifications

Plug Size	Qty.	Jobber	Order No.
.200" x 1 $\frac{1}{4}$ "	100	\$ 99.99	CRP-200
.200" x 1 $\frac{1}{2}$ "	100	114.99	CRP-201
.235" x 1 $\frac{1}{4}$ "	100	119.99	CRP-235
.327" x 1 $\frac{1}{4}$ "	50	99.99	CRP-327



High Speed Steel Drills

- 118° points for fast chip removal

Plug Size	Jobber	Order No.
.200"	\$ 6.99	CRD-200
.235"	6.99	CRD-235
.327"	6.99	CRD-327



Tapered Reamers

- High Speed Steel

Plug Size	Jobber	Order No.
.200"		Not Required
.235"	\$ 84.99	CRR-235
.327"	121.99	CRR-327



Tapered Taps

- High strength steel machined to match plug taper & thread

Plug Size	Jobber	Order No.
.200"	\$68.99	CRT-200
.235"	62.99	CRT-235
.327"	79.99	CRT-327



Ceramic Motor Seal

- Permanently seals leaking head gaskets, cracked heads and blocks (aluminum or cast iron)
- Coats the engine to inhibit rust formation and salt water corrosion during normal operation
- Seals porous castings in the cooling system
- Stops coolant leaks
- Not compatible with any anti-freeze or coolant, follow instructions on package
- Promotes heat dissipation for added power
- 16 oz./455 mL
- Order No. **CRS-16** Jobber \$22.99



Rust Inhibitor for Pressure Testing

- Clear fluid inhibits rust and does not discolor or cloud the test tank solution
- Lets you see better to pressure test
- Biocide and anti-rust additives extend tank solution life while preventing corrosion
- Synthetic formula
- Mix 20:1 with water
- Yields 20 gallons
- Order No. **PRI-10** Jobber \$29.99



.235" Crack Repair Kit

- Complete kit includes everything you need to repair cracked cast iron heads using the cold repair process • Manual included

Learn more about repairing cracks with this process; visit goodson.com and search for "Got Cracks? Here's How To Repair Them" or scan the code at right with your smart phone



Description	Jobber	Order No.	Incl.
Complete Repair Kit:	\$399.99	CRK-150	▼
100 - .235" x 1 $\frac{1}{4}$ " Threaded Iron Plugs	119.99	CRP-235	1
High Strength Steel Drill	6.99	CRD-235	1
High Strength Steel Tapered Reamer	84.99	CRR-235	1
High Strength Steel Tapered Taps	62.99	CRT-235	2
Cut-Off Saw with Blade	27.99	CR-SAW	1
Replacement Saw Blade	9.99	CR-BLADE	1
7.5 oz. Tap Oil	16.99	TAP-O	1
All Weather Seal	19.99	AWS-16	1
16 oz. Ceramic Seal	22.99	CRS-16	1

Jet Valve Eliminator Kit

- Some Mitsubishi/Chrysler 2.6L heads had jet valves while some didn't
- This kit lets you use a jet valve equipped head in place of one without
- 11mm diameter, 1.0 pitch threaded plugs replace entire valve body assembly
- Easier than welding the holes closed
- Package of 4 converts one 2.6L head
- Order No. **JVE-26** Jobber \$24.99



Head-Bolt Hole Clean-out Taps

- Clean threaded holes to prevent false torque wrench readings
- Lifts rust, dirt, chips and other debris as you remove the tool
- Use with lube and a socket wrench or slow drill
- Repairs minor damage



Size	Pitch	Length	Jobber	Order No.
1/2"	13	3 $\frac{1}{2}$ " OAL	\$ 54.99	BCT-1/2
7/16"	14	3 $\frac{1}{2}$ " OAL	51.99	BCT-7/16
10mm	2.0mm	8" Shank	144.99	BCT-10X2L
11mm	2.0mm	8" Shank	154.99	BCT-11X2L
11mm	1.5mm	8" Shank	149.99	BCT-11L

sized for LS-engines

CYLINDER HEAD REBUILDING
CLEANING, ASSEMBLY & SAFETY
SHORT BLOCK REBUILDING
FLYWHEEL GRINDING
CRANKSHAFT/ FLYWHEEL GRINDING
MISCELLANEOUS TOOLS & SUPPLIES
BRAKE SERVICE TOOLING
MEASURING TOOLS
V-TWIN & METRIC HARD PARTS

Brass or Steel Shim Stock Packs

- A handy assortment • 4" x 6" each (120 sq. in.)
- One each of .001", .002", .003", .005", .010" thick

Description	Jobber	Order No.
Brass	\$12.99	SSB-50
Steel	12.99	SSS-51

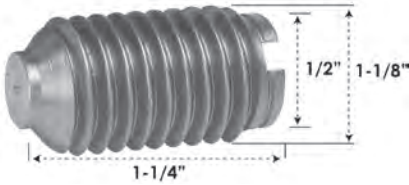

Order 5 or more,
SAVE 10% off Jobber



Smog Plugs

- Fit Ford 302 & 351
- Replace smog plugs damaged during head cleaning
- 5/8" x 11 thread outside, 7/16" x 14 thread inside
- Order No. **EMP-34** Jobber \$4.99



Mercedes .015" Head Saver Shims

- Shim cam towers if more than .015" is removed when resurfacing head
- Restores valve clearance & timing
- For 4, 5 & 6-cylinder Mercedes gas or diesel engines
- Each set shims all cam towers in one head
- Order No. **MHS-40** Jobber \$13.99

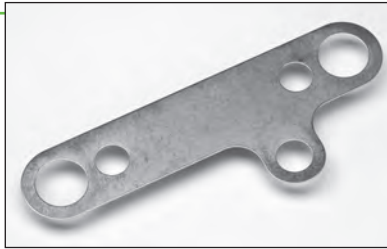

GM Vortec Adaptor Plate Set For Van Norman & Storm-Vulcan Rotary Broaches

- Required when using the Van Norman VN 530 / 570 or Storm-Vulcan 850 Storm-Mill Rotary Broaches
- Two plate set • Includes fasteners
- Order No. **VN-VOR** Jobber \$59.99

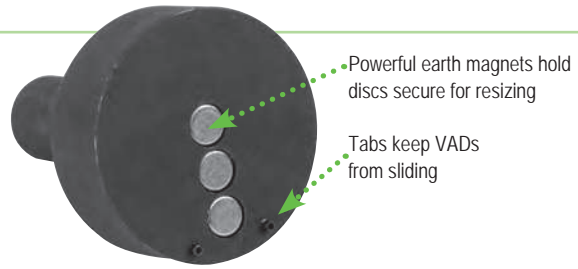
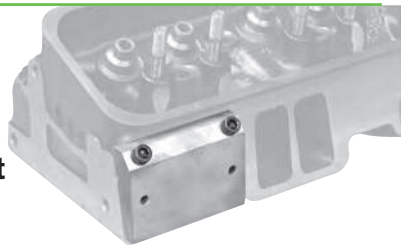

Powerful earth magnets hold discs secure for resizing

Tabs keep VADs from sliding

Magnetic VAD Holder

No more waiting for a special size – take an existing VAD and grind it to the size you need right on your valve refacer. Powerful magnets hold the VAD securely while you resize them. Tabs keep the VADs from sliding off the holder while grinding.

Description	Jobber	Order No.
Magnetic VAD Holder	\$79.99	VDR-UNI
Replacement Magnet	6.99	VDR-MAG

Resize VADs at your shop quickly and easily

tech tips
from the techxperts™

Has this happened to you? You're adjusting the clearance between the valve stem and the cams and the stock Valve Adjustment Disc (VAD) isn't the right thickness. You need a 2.25 in a 28mm diameter and the thinnest ones available are 2.50.

What are you going to do?

You could wait to have them resized by your supplier, but hey, you're a machinist! You have all of the tools and abilities right in your shop to modify the VADs you have into the VADs you need.

Place the VAD that you need to resize on your Magnetic VAD Holder (VDR-UNI, above). The powerful earth magnets will hold it securely. Using your Valve Grinder's stem end wheel, grind the VAD to the thickness you need. You're now ready to install it in the head. All in a few minutes instead of a few days.



VAD Adjusting Tools For Toyota

- Reach around the cam to depress the lifter
- Wedge holds the lifter down to free the Valve Adjustment Disc
- Reach in to remove and replace the disc
- For most models prior to 2004

Description	Jobber	Order No.
Pliers and Wedge	\$43.29	VBT-40
Wedge only	15.99	VDL-20

Spray Assembly Lube

- Ideal for prelubricating parts to ease assembly
- Eliminates critical initial run-in of new and rebuilt high-performance engine components
- Spray on bearings, crankshafts, pistons, rings, etc.
- Aerosol* • Order No. **SAL-11** Jobber \$14.99

*Hazardous Goods Fees Apply If Shipped By Air



S-373P
Pilot shown installed

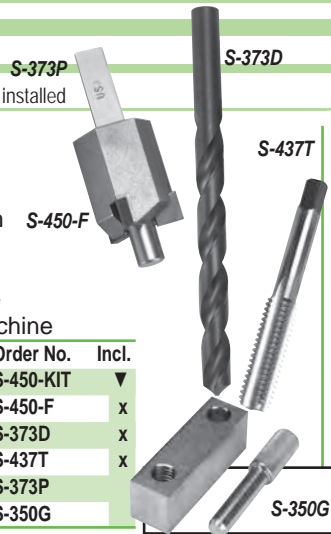

Rocker Arm Stud Conversion Kit

- Convert pressed-in rocker arm studs to threaded studs
- Remove stud, face stud boss, then drill and tap the stud hole
- Use with a seat and guide machine

Description	Jobber	Order No.	Incl.
Conversion Kit	\$139.99	S-450-KIT	▼
Stud Boss Facer	131.99	S-450-F	x
3/8" Drill Bit	12.99	S-373D	x
7/16" x 14 Thread Tap	20.99	S-437T	x
3/8" Pilot	31.99	S-373P	
2 Pc. Tap Guide	41.99	S-350G	



... another satisfied customer

"Our Top Alcohol Dragster cylinder heads have about a zillion studs of various sizes. With the Goodson Stud Removers and Installers (below), we now make short work out of this very tedious process."

- Dean Dubbin, DPM Awnings (NHRA Top Alcohol Dragster), Goodson customer since 2010

Manual Rocker Arm Stud Puller

- Heavy-duty ball bearing action
- Creates less stress and friction
- Fits 5/16" (7.9mm) and 3/8" (9.53mm) threaded studs
- Not recommended for use on thermally cleaned heads



Description	Jobber	Order No.
Complete Stud Puller	\$124.99	SP-600
Drive Nut	24.99	SP-601
Puller Body	51.99	SP-602
5/16" and 3/8" Mandrel	51.99	SP-603
Thrust Bearing	12.99	SP-604

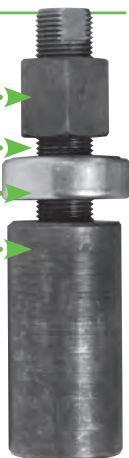

Installation

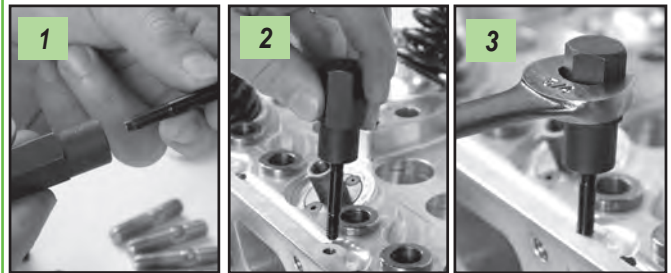

1 - Insert stud into correct size installer.

2 - Hand set the stud into the cylinder head.

3 - Use a standard 3/4" wrench or socket to tighten stud into place. Each installer is fitted with a steel ball inside to prevent over-tightening.

Universal Threaded Stud Extractor

- Use with your pneumatic impact tools & sockets (1 5/16" socket removes, 1 1/4" installs)
- Requires only 3/4" clearance to adjacent studs
- For threaded studs only
- Hardened 3-jaw clamping system
- Internal taper support
- Hollow body allows long studs to extend through the tool
- 1 1/2" dia. x 2 7/8" long • 1/4" - 1/2" range



Description	Jobber	Order No.
Universal Stud Extractor	\$154.99	PSR-500
Replacement Parts	118.99	PSR-JAWS
Spring Set	5.99	PSR-3S
Snap Ring	4.99	PSR-SR



Removal

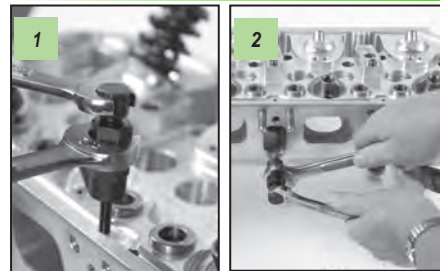

1 - Place the remover over the stud to be removed. Using 2 wrenches, back the stud out of the head.

2 - Removers can be used in virtually any position.



Torque-Angle Indicator

- When torque is given as degrees of turn past a certain ft./lb., use this gauge to show degrees
- Hold metal base with one hand
- Plastic dial turns as you tighten
- Fits between a socket-driven extension and the socket
- 1/2" square drive
- Order No. **TQR-4554**
Jobber \$21.69



Super-Stud™ Stud Installers & Removers

- Steel stamped for easy identification
- Installers include a steel ball inside to prevent over-tightening on the stud
- Removers have a 3/4" OD Hex body with a 5/8" hex jam nut on top

Description	Jobber	Order No.
Stud Installers	3/8" Fine	\$24.99 ASI-375
	3/8" Coarse	24.99 ASI-375C
	7/16" Fine	25.99 ASI-437
Stud Removers	3/8" Fine	30.99 ASR-375
	3/8" Coarse	30.99 ASR-375C
	7/16" Fine	30.99 ASR-437

CYLINDER HEAD
REBUILDING
CLEANING,
ASSEMBLY & SAFETY
SHORT BLOCK
REBUILDING
FLYWHEEL GRINDING
CRANKSHAFT/
MISCELLANEOUS
TOOLS & SUPPLIES
BRAKE SERVICE
TOOLING
MEASURING
TOOLS
V-TWIN & METRIC
HARD PARTS



"You always get more than great products from Goodson ... you also get great value!"
— Shane, Goodson Receiving, 2 year of service

American Made

CYLINDER HEAD
REBUILDING

CLEANING,
ASSEMBLY & SAFETY

SHORT BLOCK
REBUILDING

CRANKSHAFT/
FLYWHEEL GRINDING

MISCELLANEOUS
TOOLS & SUPPLIES

BRAKE SERVICE
TOOLING

MEASURING
TOOLS

V-TWIN & METRIC
HARD PARTS

Economy Cylinder Head Holder

- Holds head with either side up
- Tapered pins fit any size head bolt hole and loosen with a twist
- Ideal for guide sizing with ample clearance to remove arbors and reamers
- All blackened steel construction
- Two piece set
- Order No. **HH-100-G** Jobber \$51.99

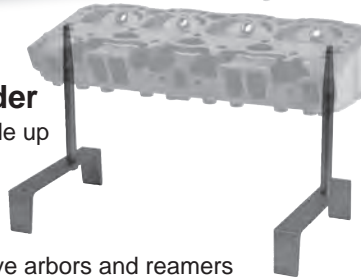

Universal Cylinder Head Holder

- Accommodates all types of cylinder heads
- Sturdy, durable, lightweight aluminum construction
- Slip-resistant neoprene covered rails
- Place heads quickly into any position and rotate them easily through 360°
- Requires no bolts, clamps or adaptors
- 2 piece set • Order No. **HH-200** Jobber \$1331.99

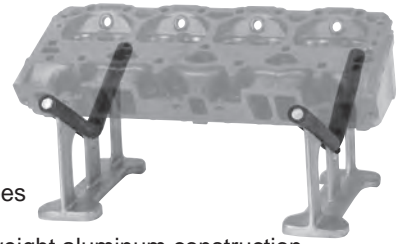

Ultra-Sturdy Cylinder Head Holder

- 360° stand holds head securely in position
- Tie-rod to prevent tipping
- Slip-resistant neoprene covered rails
- Fits domestic, foreign, truck & motorcycle heads
- 3-piece set
- Order No. **HH-450** Jobber \$99.99

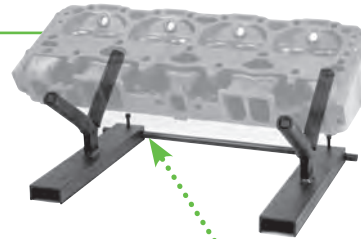

Set screws hold the two pieces firmly in place

Professional Measuring & Inspection Stand

- Length adjusts up to 23"
- Rotate work to view or measure
- Solid aluminum frame with self lubricating, corrosion and chemical-resistant wear surfaces
- Order No. **PMIS-30** Jobber \$124.99

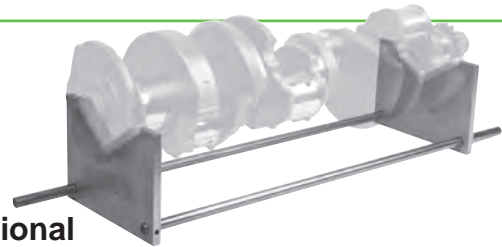

Chevy Conversion Plate Set

- Convert early model, 6-bolt heads for late model, 7-bolt applications
- Works with stock exhaust systems
- Use the standard exhaust manifold gasket or seal with High-Temp Silicone
- Order No. **CHC-10** Jobber \$27.99



Head Bolt Spot Facer

- Spot face head bolt seat parallel to new deck surface after angle milling
- Allows proper head bolt torquing
- Cutting tip radius matches OE design to avoid stress points and cracks
- .468" shank with flat
- High Speed Steel construction

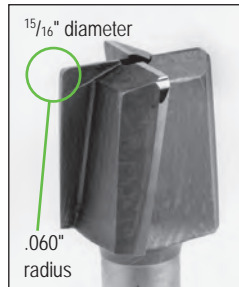

Description	Jobber	Order No.
Spot Facer	\$131.99	HBF-15
1/16" Pilot (sold separately)	15.99	GFP-437

Cut through even the hardest metals with Cutting & Tapping Fluid

- Spray clings to the surface of the tool to prolong tool life • Ideal for stainless steel, high nickel alloys, titanium and more
- Use for reaming, seat cutting and CBN cutting
- Aerosol* • Order No. **CTF-14** Jobber \$12.99



*Hazardous Goods Fees Apply When Shipped by Air

Two Blade Spot Facer

- 1 1/4" OD Spot Facer located on 3/8" stud
- Removes unneeded material for easier removal and installation of screw-in studs
- Replaceable carbide blades

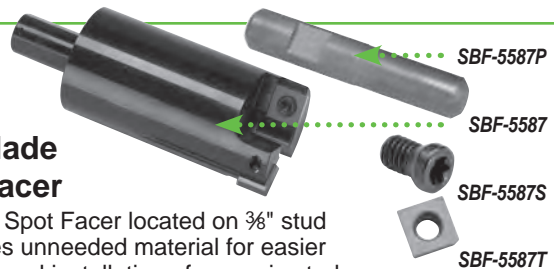

Description	Jobber	Order No.	Incl.
Stud Boss Facer	\$133.99	SBF-5587	▼
Stud Boss Facer Tip (each) for SBF-5587 only	20.99	SBF-5587T	x
Stud Boss Facer Screw (each)	6.99	SBF-5587S	x
Replacement Stud Boss Facer 3/8" Pilot (optional)	27.99	SBF-5587P	



1/4" Shank Carbide Rotary Double Cut Files

Dia.	Length	Shank	Jobber	Order No.
1/2"	1 1/8"	1.1"	\$41.99	FR-34-C
1/4"	1"	1.0"	34.99	FR-45-C

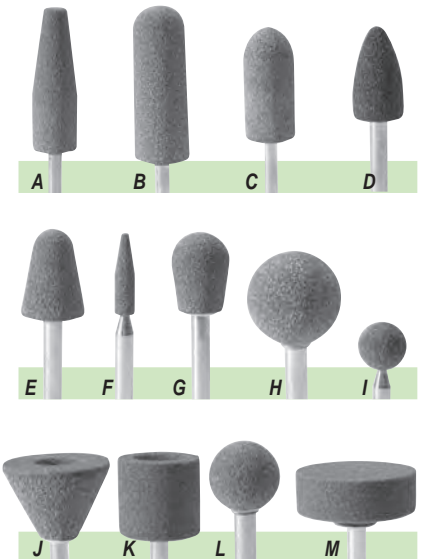

1/4" Shank Mounted Points

- Aluminum-Oxide abrasive is ideal for roughing cast iron • 1/2" shank length

Dia.	Length	Grit	Jobber	Order No.
A	3/4"	2 1/2"	60	\$8.99 GM-1
B	7/8"	2 3/4"	60	8.99 GM-3
C	7/8"	1"	60	8.99 GM-11
D	1 1/16"	1 1/4"	60	8.99 GM-12
E	3/4"	1 1/8"	60	8.99 GM-5
F	1/4"	1 1/16"	60	8.99 GM-15
G	3/4"	1"	60	8.99 GM-23
H	1"	1"	60	8.99 GM-25
I	5/8"	5/8"	60	8.99 GM-26
J	1 3/8"	1"	60	8.99 GM-31
K	1"	1"	60	8.99 GM-38
L	3/4"	3/4"	40	8.99 GM-40
M	1 1/2"	1 1/16"	60	8.99 GM-236

tech tips

Stay Safe:
 Always ensure your burr shank is well inserted into your collet and clamped down tightly.
 Keep pressure light and keep the burr moving focusing on the highest material first.
 Ensure your work is secured tightly to your work bench.
 Don't snag or jam your burr into your work
 Wear eye protection as a minimum, but better still, use a full shield for your face.

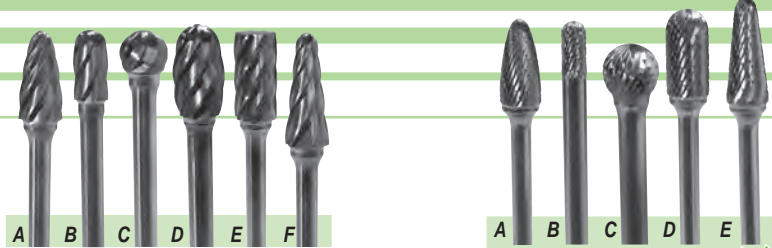

6" Long 1/4" Dia. Shank Open Fluted Rotary Files for Aluminum

- Carbide burrs
- Open flute design gives better chip discharge

Dia.	Length	Jobber	Order No.
A	1/2" 1"	\$72.99	LAFR-34
B	3/8" 3/4"	39.99	LAFR-45
C	1/2" 7/16"	59.99	LAFR-55
D	1/2" 7/8"	61.99	LAFR-70
E	1/2" 1"	61.99	LAFR-93
F	3/8" 1 1/16"	89.99	LAFR-121

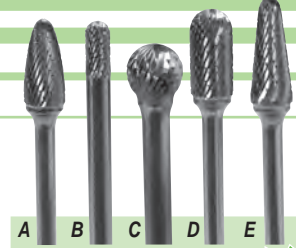

6" Long Shank Double Cut Carbide Rotary Files

- 1/4" diameter shank

Dia.	Length	Jobber	Order No.	Incl.
Complete 5 Pc. Kit		\$209.99	LFR-KIT	▼
A	1/2" 1 1/8"	51.99	LFR-34C	x
B	1/4" 1/2"	51.99	LFR-45C	x
C	1/2" 1/2"	51.99	LFR-55C	x
D	1/2" 1 1/8"	51.99	LFR-46C	x
E	1/2" 1 3/8"	51.99	LFR-141C	x

Save when you buy the kit!

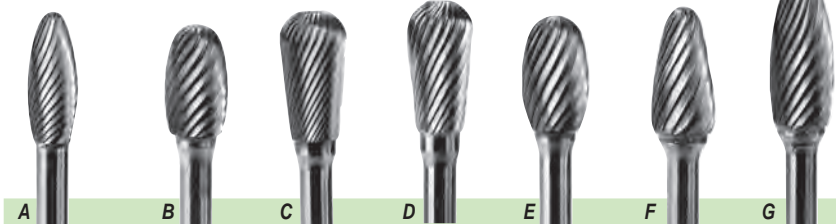

1/4" Carbide Rotary Files

- Nose design reduces back-gouging
- 1/4" shank • Shanks 4" long excepting MRT-56C at 6" long

Dia.	Lgth.	Jobber	Order No.	Dia.	Lgth.	Jobber	Order No.
A	.375" 1.000"	\$46.99	MSH-34C	E	.500" .880"	\$49.99	MSE-54C
B	.437" .875"	49.99	MSE-44C	F	.500" 1.000"	46.99	MSF-54C
C	.500" .975"	59.99	MRT-54C	G	.500" 1.245"	51.99	MSH-54C
D	.500" 1.000"	59.99	MRT-56C				

Order 5 or more Rotary Files, Burrs or Mounted Points (mix & match) and save 10% off jobber



Bifocal Magnifying Safety Glasses

- Safety glasses and cheaters all in one

Diopter	Jobber	Order No.
1.00	\$14.99	BSG-100
1.25	14.99	BSG-125
1.50	14.99	BSG-150



Mirrored Safety Glasses

- Wrap-around design
- Tinted lenses provide sun glare protection
- Universal bridge
- Polycarbonate lenses
- Do not use as welders helpers
- Order No. PGL-21 Jobber \$5.99



"When you call Goodson, you speak to a person, not a machine. We work hard to make sure you spend as little time waiting on hold as possible."
— Paige, Goodson Customer Service, 3 years of service

CYLINDER HEAD
REBUILDING

CLEANING,
ASSEMBLY & SAFETY

SHORT BLOCK
REBUILDING

CRANKSHAFT/
FLYWHEEL GRINDING

MISCELLANEOUS
TOOLS & SUPPLIES

BRAKE SERVICE
TOOLING

MEASURING
TOOLS

V-TWIN & METRIC
HARD PARTS

Aluminum Oxide Cloth Utility Shop Rolls

- 1" x 50 yards
- Easy to use ... just unroll and tear to length
- Use with butterfly mandrels



Grit	Jobber	Order No.
60	\$19.99	UR-1-60
80	19.99	UR-1-80
100	19.99	UR-1-100
120	19.99	UR-1-120
180	19.99	UR-1-180
320	25.99	UR-1-320

Crocus Cloth

- Must be used with Lapping Oil
- Great for final touch-ups on cranks, rod pins, valve stems, cams, etc.
- Use with slotted mandrels at right



Description	Jobber	Order No.
1" x 50 yd. Roll	\$39.99	UR-1-CROCUS
4 oz. Lapping Oil	10.49	LP-LO-4
8 oz. Lapping Oil	17.99	LP-LO-8

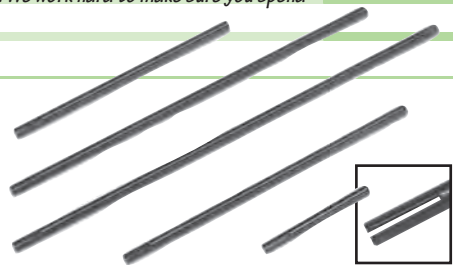

Slotted Butterfly Mandrels

- Use with roll abrasives such as those at left
- Several lengths available

Length	Jobber	Order No.
3"	\$ 5.99	BM-3
6"	10.99	BM-6
8"	11.99	BM-8
10"	24.99	BM-10
12"	16.99	BM-12

Replacement Abrasive Packs and Mandrels

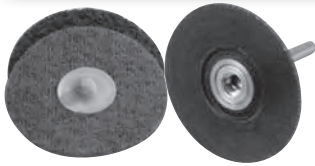

Replaceable Roll Lock Discs

10 per pack.

Dia.	Jobber	Order No.
2" Medium	\$10.49	RSCD-2M
Coarse	12.99	RSCD-2C
3" Medium	16.79	RSCD-3M
Coarse	20.99	RSCD-3C

Disc Holder	Jobber	Order No.
2" Dia.	\$14.99	RLH-2
3" Dia.	16.99	RLH-3



Aluminum Machining Aid

- Designed for aluminum
- For porting & polishing with cartridge rolls, rotary files, emery cloth or Cross Buffs®
- Safe for cast iron
- 32 oz./946.4mL
- Order No. **PF-32** Jobber \$43.99

Straight Cartridge Rolls

- 1½" long, ¼" hole
- Fully glued • Box of 50

Dia.	Grit	Jobber	Order No.
¼"	40	\$24.29	SCR-250-40
	80	24.29	SCR-250-80
	120	24.29	SCR-250-120
⅜"	40	24.29	SCR-375-40
	80	24.29	SCR-375-80
	120	24.29	SCR-375-120
	320	28.99	SCR-375-320
½"	40	29.49	SCR-500-40
	60	29.49	SCR-500-60
	80	29.49	SCR-500-80
	100	29.49	SCR-500-100
¾"	40	57.79	SCR-750-40
	80	57.79	SCR-750-80
	120	57.79	SCR-750-120
	120	57.79	SCR-750-120

Roll Mandrels

Use with straight and tapered cartridge rolls • ⅜" pilot x ¼" dia.

Length	Jobber	Order No.
2¼"	\$ 9.99	CR-275
4"	10.99	CR-40
6"	11.99	CR-60
8"	13.99	CRM-8H
10"	13.99	CRM-10H
12"	13.99	CRM-12H

Half-Tapered Cartridge Rolls

- 1½" long, ¼" hole
- Fully glued • Box of 50

Dia.	Grit	Jobber	Order No.
⅜"	40	\$36.79	HTR-375-40
	80	37.79	HTR-375-80
	120	39.99	HTR-375-120
½"	40	41.99	HTR-375-320
	40	39.99	HTR-500-40
	80	39.99	HTR-500-80

Full-Tapered Cartridge Rolls

- 1½" long, ¼" hole
- Fully glued • Box of 50

Dia.	Grit	Jobber	Order No.
⅜"	40	\$28.99	FTR-375-40
	80	27.99	FTR-375-80
	120	27.99	FTR-375-120
	320	27.99	FTR-375-320
½"	40	31.49	FTR-500-40
	60	29.49	FTR-500-60
	80	30.99	FTR-500-80
	100	41.99	FTR-500-100
¾"	120	30.99	FTR-500-120
	40	43.99	FTR-625-40
80	43.99	FTR-625-80	



Mirrored Safety Glasses

- Wrap-around design
- Tinted lenses provide sun glare protection • Universal bridge • Polycarbonate lenses • **Do not** use as welders helpers • Order No. **PGL-21** Jobber \$5.99

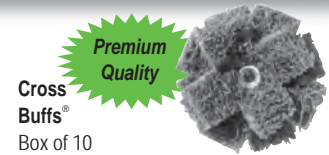

Cross Buffs®

Box of 10

Dia.	Grit	Jobber	Order No.
2-Ply			
¾"	V. Fine	\$31.49	CB-75VF
	Med.	31.49	CB-75M
1"	V. Fine	31.49	CB-1VF
	Med.	31.49	CB-1M
1½"	V. Fine	31.49	CB-15VF
	Med.	31.49	CB-15M
3-Ply			
1¼"	V. Fine	\$41.99	CB-125VF-HD
	Med.	41.99	CB-125M-HD
1½"	V. Fine	41.99	CB-15VF-HD
	Med.	41.99	CB-15M-HD



Abrasive Flapwheels

1" wide, ¼" x 20 threaded. 1 each.

Dia.	Grit	Jobber	Order No.
1½"	80	\$11.99	APK-7
2"	80	11.99	APK-8
2½"	80	11.99	APK-9
1"	120	7.99	AFW-1-120
2"	120	8.99	AFW-2-120
3"	120	10.99	AFW-3-120



Cross Buff® / Flap Wheel Mandrel

- Use with Cross Buffs & Flap Wheels above

Description	Jobber	Order No.
4" Mandrel	\$12.99	CB-MANDREL
Set Screw (3)	5.99	CB-SCREW

NOTE: Extreme caution must be used when porting & polishing. Be sure to wear safety glasses.

Professional Porting & Polishing Tools

48 Piece Deluxe Porting Kit

- Professional grade porting supplies
- Packed in a clear plastic storage case



Description	Jobber	Order No.	Incl.
48 Pc. Kit	\$94.49	DPK-100	▼
Replacement Abrasives	Grit	Kit Qty.	
Flap Wheels - 1"x1"x1/4"	120	2	\$ 7.99 AFW-1-120 x
Cross Buffs 2 Ply, 1 1/2"	Med.	2	31.49 CB-15M x
	Very Fine	2	31.49 CB-15VF x
Cross Buff/Flapwheel Mandrel		1	12.99 CB-MANDREL x
1/4" Dia. Straight	40	2	24.29 SCR-250-40 x
Cartridge Rolls	80	5	24.29 SCR-250-80 x
3/8" Dia. Straight	40	2	24.29 SCR-375-40 x
Cartridge Rolls	80	5	24.29 SCR-375-80 x
3/4" Dia. Straight	40	2	57.79 SCR-750-40 x
Cartridge Rolls	80	2	57.79 SCR-750-80 x
1/2" Dia. Half Tapered	40	2	39.99 HTR-500-40 x
Cartridge Rolls	80	5	39.99 HTR-500-80 x
5/8" Dia. Full Tapered	40	2	43.99 FTR-625-40 x
Cartridge Rolls	80	5	43.99 FTR-625-80 x
Cartridge Roll Mandrel	2 3/4" Long	1	9.99 CR-275 x
	4" Long	1	10.99 CR-40 x
Mounted Points - 3/8" x 3/4"	60	1	8.99 GM-B52 x
	1 1/16" x 1 1/4"	60	8.99 GM-12 x

See previous page for replacement abrasive quantities

small engine powersports

40 Piece Small Engine Porting Kit

- Professional grade porting supplies
- Packed in a clear plastic storage case



Description	Jobber	Order No.	Incl.
40 Pc. Kit	\$65.29	SEPK-5	▼
Replacement Abrasives	Grit	Kit Qty.	
Flap Wheels - 1"x1"x1/4"	120	2	\$ 7.99 AFW-1-120 x
Cross Buffs 2 Ply 3/4"	Very Fine	2	31.49 CB-75VF x
	1"	2	31.49 CB-1M x
	Very Fine	2	31.49 CB-1VF x
	1 1/2"	2	31.49 CB-15VF x
Cross Buff/Flapwheel Mandrel		1	12.99 CB-MANDREL x
3/8" Dia. Straight	80	4	24.29 SCR-375-80 x
Cartridge Rolls	120	4	24.29 SCR-375-120 x
	320	4	28.99 SCR-375-320 x
3/8" Half Tapered Cartridge Rolls	80	4	37.79 HTR-375-80 x
3/8" Full Tapered	80	4	27.99 FTR-375-80 x
Cartridge Rolls	120	4	27.99 FTR-375-120 x
1" x 2 Yds. Abrasive Roll	120	1	19.99 UR-1-120 x
	320	1	25.99 UR-1-320 x
Cartridge Roll Mandrel	2 3/4" Long	1	9.99 CR-275 x
	4" Long	1	10.99 CR-40 x

See previous page for replacement abrasive quantities

Intake Port Reshaping Kit

- Superior formula uses 2-part epoxy
- Won't shrink when dry
- Mix ratio is 1:1 by weight
- Mix and knead the parts together by hand until the yellow and black colors have combined to make a uniform olive green color
- Working time at 70°F: Golfball size mix: 40 minutes max.; Baseball to softball size: 30 minutes max.
- Cure time at 70°F: full hardness in 6 to 8 hours
- Once cured, forms a hard coating resistant to abrasion, impact, water, chemicals and solvents
- **Not** for use in contact with potable water or exhaust ports
- Can be milled or machined
- Withstands temperatures up to 500°F/ 260°C
- Kit includes epoxy, gloves and mixing sticks
- Yields 16 oz./453.6g of material
- 24 month shelf-life
- Order No. **PRK-99** Jobber \$36.99



tech tips
from the techxperts™

Adhesion of PRK-99 will be only as good as the cleanliness and soundness of the substrate. Remove all dirt, oil and grease. Sandblasting is acceptable. Scraping, wire brushing and other manual cleaning methods may also work.

Quick Change Mandrels & Abrasive Sleeves

- 5 sleeves per pack • 1" x 1"
- Mandrel has 1/4" shaft



Description	Grit	Jobber	Order No.
Mandrel		\$8.99	GMS-101
Sleeves	40	8.99	GMS-140
	60	8.99	GMS-160

110V Electric Die Grinder

- 1/4" collet • 8' cord • 110V • 2.5 amp • 25,000 RPM
- Includes 2 collet wrenches
- Optional Speed Control lets you vary from 200 to 25,000 RPM • 6' cord • 110V • 15 amp

Description	Jobber	Order No.
25,000 RPM Die Grinder	\$219.99	GEO-600
Variable Speed Control	46.99	GEO-SC
1/4" Grinder Replacement Collet	38.99	GEO-600-5
Grinder Replacement Collet Nut	7.99	GEO-600-4



NOTE: Extreme caution must be used when porting & polishing. Be sure to wear safety glasses.

... another
satisfied
customer

"When rebuilding several motors at a time, your organizer trays are very important. We love the thought given in the products and how parts remain in important order!"

- George Bernacchi, 88 Tire Shop, via Facebook

CYLINDER HEAD
REBUILDING

Dual Overhead Cam Cylinder Head Organizer Tray

- Store valves, springs, retainers, keepers, valve lash adjusters & camshafts
- Keep valve lash adjusters from getting mixed up and changing the valve adjustment
- Heavy duty construction
- Oil and solvent resistant
- 23¼" x 26½" x 2"
- Order No. **DOHC-1** Jobber \$48.99

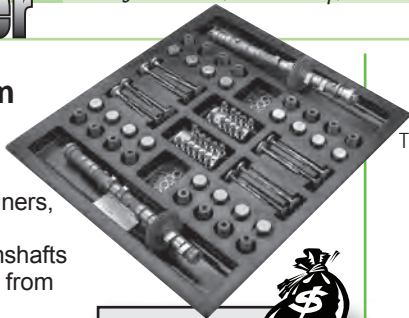

Parts Trays

Order 6 or more and SAVE 10% off jobber, Mix or match trays to make quantities



CLEANING,
ASSEMBLY & SAFETY

SHORT BLOCK
REBUILDING



Stackable Cylinder Head Organizer Trays

- Store valves, springs, retainers and keepers in order of assembly • Impervious to oil and most solvents
- Measures 28" x 12½" x 3"H
- Order No. **SHO-8** Jobber \$56.99

CRANKSHAFT/
FLYWHEEL GRINDING

MISCELLANEOUS
TOOLS & SUPPLIES

Valve Train Tray For 4, 6 or 8-Cylinder OHV Engines

- Heavy duty construction
- Keeps push rods, rockers, lifters, etc. in order
- 64 compartments
- Measures 11½"W x 13½"D x 1½" H
- Order No. **VTO-80** Jobber \$48.99

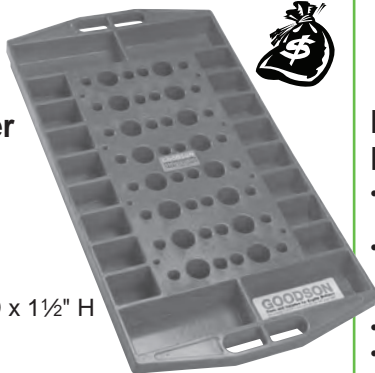

BRAKE SERVICE
TOOLING

MEASURING
TOOLS

Organizer Safety Pins Keep Part Sets Together

Parts Safety Pin • Organize valve springs, rods, etc., from disassembly to cleaning to reassembly
Rod & Cap Mini Pin • Keep connecting rods & rod caps together to prevent mix-ups

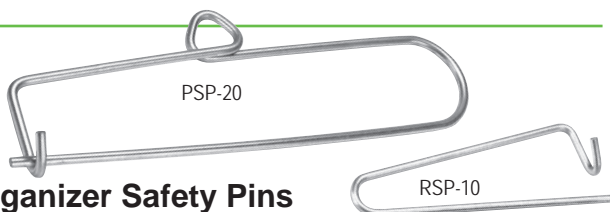

Description	Jobber	Order No.
Parts Safety Pin (3¾" x 12")	\$8.99	PSP-20
Rod & Cap Mini Pin (¾" x 4")	5.99	RSP-10

V-TWIN & METRIC
HARD PARTS

Engine Storage Cart

- An efficient space-saver
- Heavy-duty casters
- Holds all engine parts off the floor from tear-down to reassembly in less than 4 square feet
- Move the whole engine easily
- Some assembly required
- Order No. **EC-200** Jobber \$389.99

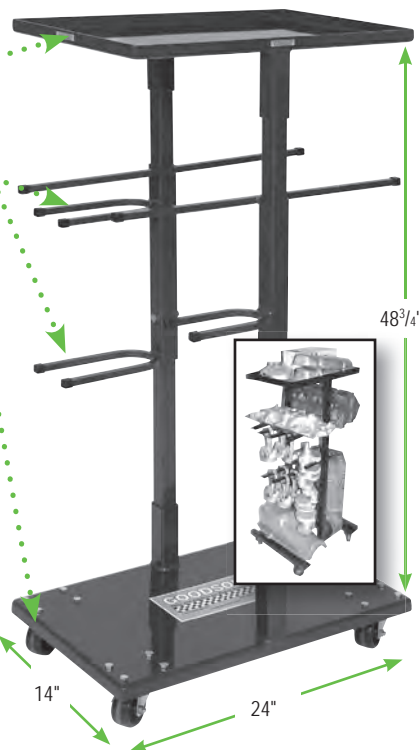

Top tray features 1" deep lip to keep parts from rolling off

Solid steel hangers hold piston rods and crankshafts
Heavy duty casters make moving the engine and cart easy

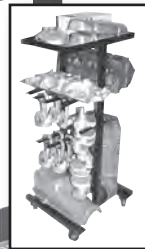

Ford/Chevy Small Block Organizer Tray

- Store pistons, rods, lifters, push rods & camshafts
- Formed compartments keep engine components securely in place
- Measures: 24¼" x 25½" x 1½"D
- Order No. **IEO-80** Jobber \$33.99

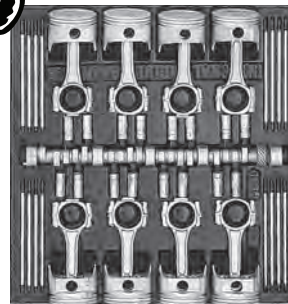

Parts Tags & Marker

- Won't tear or wash off
- Heavy wire ties
- Tough enough to go through a jet wash or hot tank
- Includes 2 Super-Permanent markers with specially formulated ink to withstand most chemicals and extreme heat and steam up to 500°F
- Tag dimensions: 3½"L x 5/8"W with 5/32" hole for wire tie



Description	Jobber	Order No.
1000 Parts tags, with 2 markers	\$61.99	IDT-1000
Super-Permanent Marker only	2.99	IDT-MARKER

Rust Proofing Oil

- 1 Gallon / 3.78 L
- Apply full strength
- Creates a protective film
- Washes off with standard solvents
- Brush or spray on
- Order No. **RPO-10** Jobber \$89.99



Order 6 or more cans (any combo), save 10% off jobber



Rust Shield

Short-term

- Non-sticky
- Lasts several weeks
- Wipes off with just a towel

Long-term

- Formula is thicker and protects much longer but requires a solvent to remove

Formula	Jobber	Order No.
Short Term	\$13.99	RS-16*
Long Term	16.99	RS-16-OD*

*Hazardous Fees Apply If Shipped By Air



Rust Shield for Shop Equipment

- Stops rust without causing rancidity
- Apply to machine parts such as ways
- Mixes with coolant – no need to remove before machining
- 1 Gallon / 3.78 L
- Order No. **RS-128** Jobber \$27.99



Petroleum Based Rust Inhibitor

- Brush directly from can onto freshly-machined engine components
- Protects iron, steel and aluminum
- Soften with mineral oil to dip small parts

Quantity	Jobber	Order No.
2 lbs.	\$ 31.99	RPC-2A
35 lbs.	379.99	RPC-35A



Snap Together Adjustable Coolant Hoses

- Hoses hold any shape • Chemical Resistant
- Ideal for most common shop machines

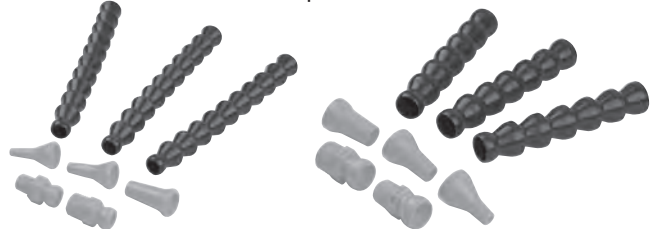

Size: 1/4" Hose Kit
Includes: 18" hose, 1/4" & 1/8" NPT fittings, 1/16", 1/8" & 1/4" round nozzles

Application: Most parts washers, wet-type seat grinders, valve refacers

Order No.: **ACH-400** Jobber \$16.99

Size: 1/2" Hose Kit
Includes: 16 1/2" hose, 3/8" & 1/2" NPT fittings, 1/4", 3/8" & 1/2" round nozzles

Application: Most cylinder hones and flywheel grinders

Order No.: **ACH-600** Jobber \$17.99

Universal Coolant Magnet

- Ideal for Honing Tanks, Flywheel Grinders, Crankshaft Grinders, Head Surfacers and more
- Prevents metal swarf from passing into the coolant tank
- Cut or shape to fit machine bases and return ways
- Measures 3"x48" • Can be trimmed to any size needed
- Order No. **UCM-348** Jobber \$23.99

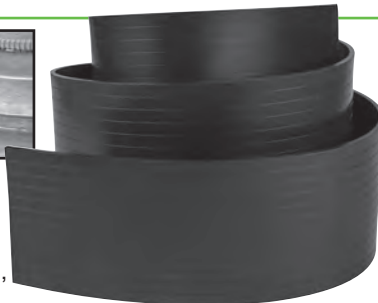

Size: 1" Flare Nozzle for 1/4" Hose

Order No.: **ACH-407**

Jobber \$8.99



Size: 1 1/4" Flare Nozzle for 1/2" Hose

Order No.: **ACH-807**

Jobber \$9.99

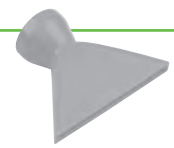

Size: 2 1/2" Flare Nozzle for 1/2" Hose

Order No.: **ACH-809**

Jobber \$10.99



NPT	Hose ID	Order No.
1/4"	1/4"	ACH-406
3/8"	1/2"	ACH-804
1/2"	1/2"	ACH-805

Jobber ea. \$7.99

Hose ID	Length	Order No.
1/4"	11"	ACH-801
1/2"	11"	ACH-801

Jobber ea. \$12.99

Coolant & Solvent Pumps

Ideal for Parts Washers

170 Gal. Per Hour Pump

- HP: 1/125
- Capacity: 170 gal/hr. at 1" depth • Hi-temp Seals
- Voltage: 115
- Size: 4" x 3 3/4" x 2 3/4"
- Order No. **COP-166** Jobber \$123.99



Ideal for Flywheel Grinders

1200 Gal. Per Hour Pump

- HP: 1/6
- Capacity: 1200 gal/hr. at 1" depth
- Voltage: 115
- Size: 7 3/4" x 6 1/8" x 4 5/8"
- Order No. **COP-1833** Jobber \$164.99



Sludge Filter Bag

- Fits any machine with a coolant sump
- Replace costly OE filters with this economical, universal sock
- Adds filtration to machines that don't have enough • 8" x 24" polyester knit sock
- Order No. **SB-1** Jobber \$9.99



CYLINDER HEAD REBUILDING
CLEANING, ASSEMBLY & SAFETY
SHORT BLOCK REBUILDING
CRANKSHAFT/ FLYWHEEL GRINDING
MISCELLANEOUS TOOLS & SUPPLIES
BRAKE SERVICE TOOLING
MEASURING TOOLS
V-TWIN & METRIC HARD PARTS

CYLINDER HEAD
REBUILDING

CLEANING,
ASSEMBLY & SAFETY

SHORT BLOCK
REBUILDING

CRANKSHAFT/
FLYWHEEL GRINDING

MISCELLANEOUS
TOOLS & SUPPLIES

BRAKE SERVICE
TOOLING

MEASURING
TOOLS

V-TWIN & METRIC
HARD PARTS



End Brushes

Dia. / Wire gauge / Type	Jobber	Order No.
Standard Duty		
1/2" .020" crimped	\$ 8.99	GBC-4
3/4" .020" crimped	10.99	GBC-6
1" .020" crimped	12.99	GBC-10
1 1/2" .020" crimped	9.99	GBC-14
1 3/4" .012" crimped	12.99	NH-16
2 3/4" .012" crimped	15.99	NH-26
1 3/4" .014" galv. for alum.	9.99	ANH-16
2 3/4" .014" galv. for alum.	9.99	ANH-26
Ultra Duty (listed left to right)		
1/2" .014" crimped	\$ 8.99	GBC-4A
1 1/8" .020" knotted, 1 1/4" L	13.99	GBC-12
1 1/8" .020" knotted, 7/8" L	15.99	GBC-12HD
3/4" .020" knotted	11.99	NH-6

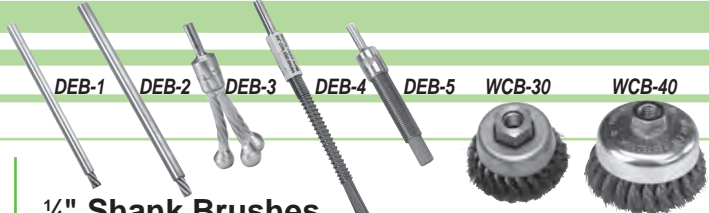

1/4" Shank Brushes

Deep Well End Brush as brush wears cut back to expose new wire				
Dia.	Wire Gauge	Grade	Jobber	Order No.
1/4"	.012", 6" long	Economy	\$12.99	DEB-1
3/8"	.017", 6" long	Economy	16.99	DEB-2
Flare Brush use to remove carbon from engine ports				
1/2" ball, 5/16" cable		Ultra-duty	\$49.99	DEB-3
Port Brush as brush wears cut back spring for new wire				
1/4"	.014", 4" long	Standard	\$21.99	DEB-4
1/2"	.020", 2 1/2" long	Ultra-duty	21.99	DEB-5
Cup Brush 5/16"-11 NC - fits standard 4 1/2" angle grinder				
3"	.014" twisted	Ultra-duty	\$24.99	WCB-30
4"	.014" twisted	Ultra-duty	33.99	WCB-40

Order 10 or more brushes, (any combination) take 10% off jobber



Engine Prep Brushes

Application	Jobber	Order No.
For small feed hole in block		
1/4" x 2" x 10", nylon	\$5.99	OB-1
For Block Oil Return Line		
5/16" x 2 1/2" x 12", nylon	5.99	OB-2
Like OB-2 but more flexible		
5/16" x 2 1/2" x 12", nylon	5.99	OB-2A
For Block Oil Return Lines		
3/8" x 2 1/2" x 12", nylon	5.99	OB-3
For diesel injector		
1 3/4" brush, stainless	7.99	DIB-1
For lifter bores		
1" x 3" x 14", nylon	8.99	LBB-100

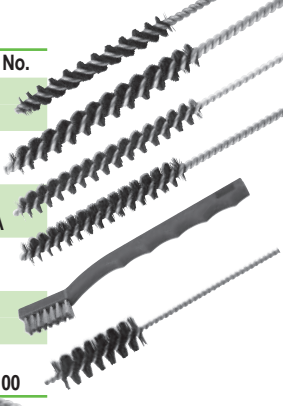

Manual Guide Cleaning Brush

- 1/2" Dia. Nylon bristles
- OAL: 8 3/4"
- Order No. **WCB-44**
- Jobber \$3.99

Round Fiber Parts Brush

- 11" long • Nylon bristles
- Plastic Handle
- Order No. **PCB-348**
- Jobber \$7.99

Lifter Bore Brushes

Dia.	Job	Order No.
7/8"	\$7.49	LBB-875
1"	8.99	LBB-100
1 1/8"	8.49	LBB-1125

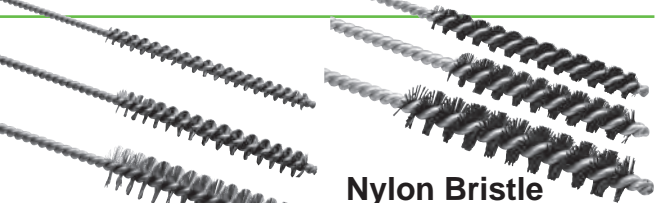

Nylon Bristle Oil Gallery Brushes

Desc.	Jobber	Order No.
5-pc. Kit	\$27.99	OGB-KIT ▼
3/8" x 3" x 34"	6.99	OGB-38 x
1/2" x 2 1/2" x 34"	6.99	OGB-42 x
5/8" x 3" x 34"	6.99	OGB-5 x
3/4" x 3" x 34"	7.99	OGB-7 x
3/4" x 3" x 40"	8.99	OGB-8 x

Steel Wire Oil Gallery Brushes

Desc.	Jobber	Order No.
3-pc. Kit	\$16.99	OGB-SK ▼
1/4" x 3" x 24"	7.99	OGB-1 x
3/8" x 3" x 24"	8.99	OGB-2 x
5/8" x 3" x 24"	9.99	OGB-3 x

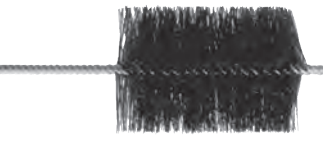

Bore Washing Brushes

Dia.	Length	Jobber	Order No.
2"	36"	\$19.99	CBB-200
2 1/4"	36"	20.99	CBB-225
2 1/2"	36"	21.99	CBB-250
2 3/4"	18 1/2"	19.99	CWB-27W
3 1/2"	18 1/2"	19.99	CWB-35
4"	18 1/2"	19.99	CWB-40
4 1/2"	18 1/2"	21.99	CWB-45
5"	18 1/2"	22.99	CWB-50

Flow Through Parts Washing Brush

- 24" long hose slides over discharge nozzle on parts washer
- Order No. **PWB-FLO-1**
- Jobber \$27.99



Pushrod Brush

- Clean the inside diameter of your pushrods with this brush
- Fits pushrods as small as .080" ID
- 12" overall length
- Order No. **PRB-80**
- Jobber \$13.99

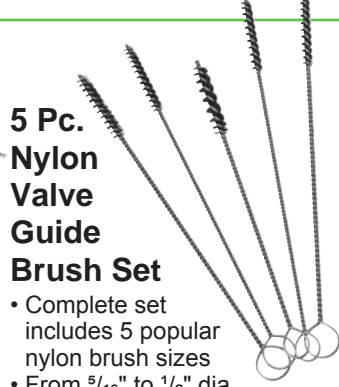

5 Pc. Nylon Valve Guide Brush Set

- Complete set includes 5 popular nylon brush sizes
- From 5/16" to 1/2" dia.
- Order No. **GVP-SET**
- Jobber \$33.99

Valve Guide Brushes

Size	Steel Brushes		Nylon Brushes	
	OAL	Order No.	OAL	Order No.
5/16" x 2 1/2"	9 1/2"	GVP-1	12"	GVP-1N
1 1/2" x 2 1/2"	9 1/2"	GVP-2	12"	GVP-2N
3/8" x 2 1/2"	9 1/2"	GVP-3	12"	GVP-3N
7/16" x 2 1/2"	9 1/2"	GVP-4	12"	GVP-4N
1/2" x 2 1/2"	-----	-----	10 1/2"	GVP-5N
9/16" x 2 1/2"	-----	-----	10 1/2"	GVP-6N
3mm x 1 1/4"	-----	-----	8"	GVP-7N
4mm x 1 1/4"	8"	-----	8"	GVP-8N
5mm x 1 1/4"	8"	-----	8"	GVP-9N
6mm x 1 1/4"	8"	GVP-10S	8"	GVP-10N
7mm x 1 1/4"	8"	GVP-11S	8"	GVP-11N
Jobber ea.		\$6.99		\$6.99





Order 10 or more brushes,
(any combination) take 10% off jobber.



Radial Wire Brushes

Radial Wire Brushes

- American made oil tempered high carbon steel wire
- High density for faster cleaning and longer life
- Excellent balance • 1/2" - 5/8" arbor

Size	Wire	Duty	Jobber	Order No.
6" x 1 3/8"	.014" Crimped	Std.	\$21.99	ADA-6
7" x 1/8"	.014" Crimped	Heavy	47.99	DA-7
6" x 3/8"	.016" Twisted	Super	21.99	TS-6
8" x 3/4"	.016" Twisted	Super	56.69	TS-8
6" x 1/8"	.023" Knotted	Ultra	24.99	QTC-6



Buy the Kit,
SAVE!

BG-KIT

Engine Rebuild Brush Kit

- Includes the brushes you'll need for an average engine job
- A great starting place, then add more brushes as you need them • Replacement brushes available

Description	Jobber	Order No.
Standard Brush Kit - 10 Pc. Kit	\$54.99	BG-KIT ▼
4" Nylon Cylinder Washing Brush	19.99	CWB-40 x
1 1/2" Nylon Valve Guide Brush	6.99	GVP-2N x
3/8" Nylon Valve Guide Brush	6.99	GVP-3N x
Lifter Bore Brush	8.99	LBB-100 x
Small Nylon Feed Hole Brush	5.99	OB-1 x
Block Oil Return Line Brush	5.99	OB-2 x
3/8" Oil Gallery Brush	6.99	OGB-38 x
1/2" Oil Gallery Brush	6.99	OGB-42 x
5/8" Oil Gallery Brush	6.99	OGB-5 x
Round Fiber Parts Brush	7.99	PCB-348 x

Nozzle

Water Shut-Off Valve

Hydro-Air Gun

- Hold by the air supply hose
- Use with hot or cold water
- The grip stays cool even when spraying hot water
- Maintenance free design
- Compact for reaching into tight areas
- Replacement parts available

Description	Jobber	Order No.
Hydro-Air Gun Assembly	\$94.99	BG-150
Replacement Water Shut-off	10.99	BG-150W
Replacement Nozzle	23.99	BG-150A

new

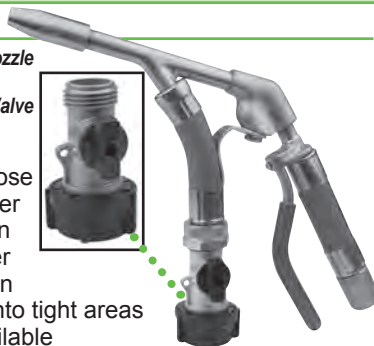

Super Scraper™

- Remove gaskets, carbon, rust, paint, etc.
- Precision-ground
- Solid carbide-tipped
- Double-edged blade
- Lasts longer than plain steel
- Nickel-chrome • 1/8" thick steel shank
- For all metals including aluminum

Width	Jobber	Order No.	Incl.
3 Pc. Set	\$94.99	SS-SET	▼
5/8"	25.99	SS-4U625	x
1 1/4"	32.99	SS-4U	x
2"	44.99	SS-4U2	x



Pneumatic Scraper

- Faster and easier than scraping by hand
- Beveled, 1" steel blade • Removes gaskets with 2500, 3/64" strokes per minute • Blade can be resharpened

Description	Jobber	Order No.
Complete Tool	\$99.99	AGS-310
Replacement Blade	16.99	AGS-310B
Premium Replacement Blade	18.99	AGS-310BP

Roloc Bristle Discs

- Effective on cast iron, yet safe for aluminum
- Abrasive grains embedded in plastic bristles that break down exposing new grain

Roloc Bristle Discs						
Size	Color	Grit	Max. RPM	Jobber	Order No.	
2"	Green	50	25,000	\$12.99	RBD-2G	
	Yellow	80	25,000	12.99	RBD-2Y	
	White	120	25,000	12.99	RBD-2W	
3"	Green	50	18,000	19.99	RBD-3G	
	Yellow	80	18,000	19.99	RBD-3Y	

Holders			
Size	Description	Jobber	Order No.
2"	Roloc-Type Holder	\$14.99	RLH-2
3"	Roloc-Type Holder	16.99	RLH-3

ARMEX®

Maintenance XL Formula Soda Blast Cleaning Media

- 270 micron / 70 Grit Formula
- Use to strip clean almost any car surface including, steel, aluminum, Fiberglass® and plastics
- Ideal for blocks, heads and intake manifolds
- Dissolves in warm water, minimizing particle ingestion that can block fuel lines and passageways
- Won't damage the surface you're cleaning
- Non-toxic and non-hazardous with a pH of 8.2
- 50 lb. / 22.7 kg bags
- Order No. **SMB-170** Jobber \$36.99





"We believe that every customer is important. If you need one of our tools or supplies overnight or have a last minute change on your order you can count on Goodson. You'll always receive the kind of courteous, personal attention that shows how much we appreciate you doing business with us."
- Cammy, Goodson Operations Manager, 2 years of service

CYLINDER HEAD
REBUILDING

CLEANING,
ASSEMBLY & SAFETY

SHORT BLOCK
REBUILDING

CRANKSHAFT/
FLYWHEEL GRINDING

MISCELLANEOUS
TOOLS & SUPPLIES

BRAKE SERVICE
TOOLING

MEASURING
TOOLS

V-TWIN & METRIC
HARD PARTS

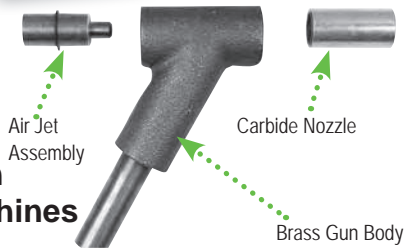

Glass Bead Gun for Smaller Machines

- Solid brass body
- Fits Trinco, Econoline, etc.
- Includes Gun Body, Nozzle and Air Jet Assembly
- Replacement parts available

Description	Jobber	Order No.
Complete Gun For Smaller Machines	\$108.99	GB-113
Replacement Parts		
Gun body only	\$61.99	GB-111
Carbide nozzle 19.05mm OD, 7.94mm ID	49.99	GB-204
Air jet assembly 3.97mm ID, 25 CFM	20.99	GB-330

Replacement Trigger-Control Glass Bead Gun

- Uses 9 CFM of compressed air
- Gun includes replaceable ceramic nozzle
- Nozzle diameter: 3/16"
- For most economy bench-top glass bead cabinets
- Fits most cabinets with 1/2" ID media supply line, threaded for 1/4" air line fitting



Description	Jobber	Order No.
Trigger-Control Glass Bead Gun	\$102.99	GB-9
Replacement Ceramic Nozzles (3 pack)	41.99	GB-9-NOZ

Glass Beads

- Clean parts thoroughly without removing material
- 50 lb. bag • Size #8
- Safe for ferrous & non-ferrous materials
- Order No. **GB-CM**
Jobber \$51.99

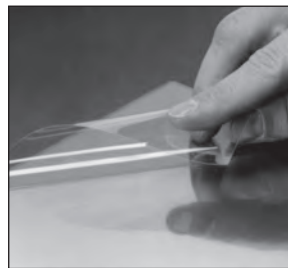
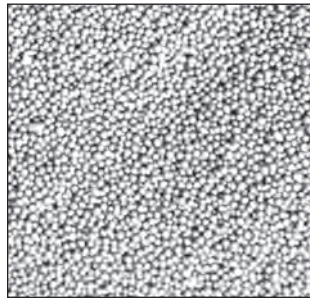

tech tips

from the techxperts™
For best results, attach film to cabinet window with ordinary double-faced tape (not included).

Glass Bead Cabinet Window Film

- Protects the inside of glass bead cabinet windows
- Save time and money – replace the film rather than the glass • 24" x 10' roll
- Order No. **GB-FILM**
Jobber \$19.99

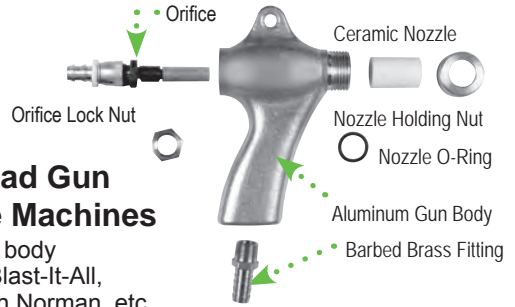

Glass Bead Gun for Large Machines

- Solid brass body
- Fits Zero, Blast-It-All, Winona Van Norman, etc.
- Includes .313" ID ceramic nozzle

Description	Jobber	Order No.
Complete Gun For Larger Machines	\$144.99	GB-100
Replacement Parts		
Gun body only	\$85.99	GB-101
Barbed Brass fitting	8.99	GB-04
Nozzle holding nut (not included in kit)	15.99	GB-54

Rebuild Kits	Jobber	Order No.	Includes
.250" ID	\$59.99	GB-4-OK	▼
.313" ID	59.99	GB-5-OK	▼
.375" ID	59.99	GB-6-OK	▼
.437" ID	64.99	GB-7-OK	▼
Ceramic Nozzles			
.250" ID	23.99	GB-74	x
7/8" OD x 1 1/8"	23.99	GB-75	x
.375" ID	23.99	GB-76	x
.437" ID	28.99	GB-77	x
Replacement Orifices			
	46.99	GB-64	x
	46.99	GB-65	x
	46.99	GB-66	x
	46.99	GB-67	x
Lock Nut	9.99	GB-52	x x x x
O-Ring	6.99	GB-53	x x x x



Glass Bead Gloves

- 30" overall length
- For ports up to 10" diameter
- Durable cloth-lined Neoprene glove with nylon sleeve
- Sleeve design makes attaching glove to your machine, faster and easier • Clamp sold separately

Port Size	Description	Jobber	Order No.
Up to 8" (20.32 cm)	Single: left-hand glove	\$34.99	GB-654-G
	Single: right-hand glove	34.99	GB-655-G
	Pair: one right-hand & one left-hand	59.99	GB-660-G
	Pair+: one right-hand, two left-hand	89.99	GB-663-G
Up to 10" (25.4 cm)	Single: left-hand glove	39.99	GB-754-G
	Single: right-hand glove	39.99	GB-755-G
	Pair: one right-hand & one left-hand	77.99	GB-770-G
	8" and 10" Replacement Clamp: fits both port sizes	8.99	GB-CLAMP

SAFETY TIP: NEVER point the Glass Bead Gun at the cabinet window or your co-workers!

Cleaning Media



Ceramic Diagonals (20 lb.)
For soft materials such as brass and aluminum. 5/16" dia., 5/8" long
Order No. **PTM-20CR** Jobber \$72.99



Steel Ballcones (20 lb.)
Ideal for Springs.
.385" ball in .475" cone
Order No. **PTM-20BC** Jobber \$154.99



Steel Diagonals (20 lb.)
Ideal for valves.
5/16" dia., 5/8" long
Order No. **PTM-20D** Jobber \$154.29

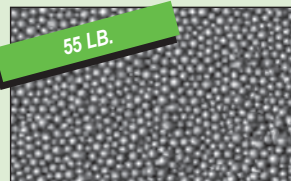

Steel Shot, 170 grade (55 lb.)
Ideal for cleaning cast iron heads.
Diameter varies from .017" to .024".
Order No. **SS-CM** Jobber \$49.99

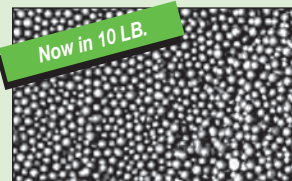

Stainless Steel Shot, Conditioned.
Clean aluminum heads to look like new.
Restores bright aluminum finish. Lasts longer than plain carbon steel shot.
Diameter varies from .006" to .016".
10 lb.
Order No. **SS-CS10** Jobber \$69.99

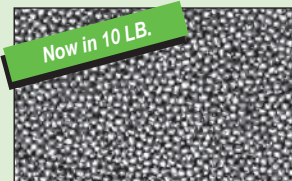

Stainless Steel Cut Wire Shot
Unconditioned. Clean cast iron or aluminum heads before and normalize after welding. Helps prevent surface corrosion after blasting.
.020" Diameter. 10 lb.
Order No. **SS-CW10** Jobber \$109.99



Hot Tank Gloves

- Sold in pairs
- Not for solvent use
- Shoulder length features eyelets & strings at tops to prevent slipping

Description	Jobber	Order No.
Gauntlet Length (14" long)	\$24.99	HTG-200
Elbow Length (18 1/2" long)	35.99	HTG-200E
Shoulder Length (34 1/2" long)	59.99	HTG-200L



See Pages 126-127 for Keepers

Keeper-Keeper

- Screws closed tightly
- 1/4" holes
- Ideal for tumbling keepers
- Solvent resistant PVC
- Order No. **VK-15** Jobber \$15.99



See Page 125 for Valve Stems

Valve Stem Protectors

- Protects against parts tumbler damage
- Slips on and off easily
- 16 per package
- Order No. **VSP-16** Jobber \$12.99



Full Length Neoprene Shop Apron

- Protects from caustics, steam, grease and oil
- Bib-style • 35" x 45"
- Order No. **HTA-300** Jobber \$30.99

Shown with Shoulder Length Hot Tank Gloves (above)

Cloth Shop Apron

- Bib-style apron
- Heavy duty black fabric
- Several handy pockets
- Embroidered Goodson Racing logo
- Machine Washable
- Order No. **CA-100** Jobber \$27.99



Parts Tumbler Solution

- Dilute 30:1 with water
- For best results, dry parts with compressed air • 1 gallon / 3.78L
- Order No. **PT-SOL** Jobber \$13.99

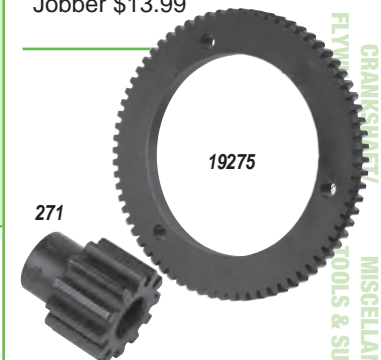

Replacement Gears For Sioux™ 710 Parts Tumbler

- Replaces discontinued Sioux™ parts

Description	Jobber	Order No.
Steel Gear	\$61.99	271
Fiber Gear	59.99	19275



Parts Tumbler Basket

- Fits Goodson, K.I., Axe, RMC, and Peterson
- 8" x 12" x 12"
- Order No. **PT-BASKET** Jobber \$369.99

CYLINDER HEAD REBUILDING
CLEANING, ASSEMBLY & SAFETY
SHORT BLOCK REBUILDING
FLYWHEELS
CRANKSHAFTS
MISCELLANEOUS TOOLS & SUPPLIES
BRAKE SERVICE TOOLING
MEASURING TOOLS
V-TWIN & METRIC HARD PARTS



"We offer every customer the opportunity to open a Goodson account for faster, easier ordering and to save you money on C.O.D. shipments. Call today for details!"

- Diane, Goodson Customer File Maintenance - 18 years of service

CYLINDER HEAD
REBUILDING

Organize, Clean And Store Small Parts With GOODSON Small Parts Baskets

- Galvanized, welded 1/4" mesh
- Withstands most solvents
- Not for use in caustics



Small Basket with Lid

- 2 1/4" dia. x 7" L
- Order No. **PWB-2**
- Jobber \$11.99



Medium Basket with Lid

- 4 1/2" dia. x 7" L
- Order No. **PWB-4**
- Jobber \$13.99

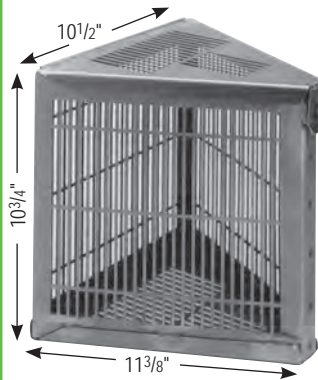

Jet Wash Parts Basket Makes a 24" Circle

- Triangle-shaped • Sit side by side on Jet Wash table
- Fit more baskets in the machine to clean faster
- Order No. **JWB-6**
- Jobber \$99.99

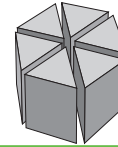

Six baskets fit in 24" diameter

Buy 3 and save 10% off jobber



CLEANING,
ASSEMBLY & SAFETY



Single Basket with Handle

- 8" dia. x 9" L
- Lid & clip sold separately
- Order No. **PWB-10**
- Jobber \$14.99



Single Basket with Lid, Clip & Handle

- 8" dia. x 9" L
- Order No. **PWB-15** Jobber \$23.99

SHORT BLOCK
REBUILDING

CRANKSHAFT/
FLYWHEEL GRINDING

MISCELLANEOUS
TOOLS & SUPPLIES

Double Basket with Clip

- 9" dia.
- 16" L
- Hinged on one side
- Order No. **PWB-25**
- Jobber \$24.99



Lid & Clip

- For PWB-10
- Order No. **PWB-10L**
- Jobber \$9.99

Clip Only

- Order No. **PWB-15C**
- Jobber \$3.99

BRAKE SERVICE
TOOLING

MEASURING
TOOLS

V-TWIN & METRIC
HARD PARTS

50 Pack Machine Washable Cotton Shop Towels

- 15" square
- Highly absorbent
- Order No. **WST-50**
- Jobber \$17.99



Lint-Free Disposable Assembly Wipes

- Snow-white
- Pop-up box • 9" x 17"
- Ideal for a multitude of uses at the shop, at the track, even at home!
- 220 pack
- Order No. **AW-250**
- Jobber \$25.99



Flock Lined Nitrile Parts Gloves

- Nitrile exterior with diamond grip pattern
- Flock lined • Won't swell • 13" long
- Safe for solvents • Sold as pairs

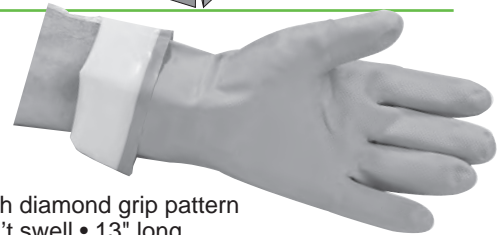

Size	Jobber	Order No.
Large	\$ 8.99	PWG-SOL-L
X-Large	11.99	PWG-SOL-XL

Get the Right Size Gloves

Size	Inches
L	3.5" to 4.0"
XL	3.9" to 4.4"



Unlined Nitrile Gloves

- 8 mil thick textured Nitrile
- Dispenser style box holds 50 gloves
- 12" Long • Fit either hand
- Not for prolonged direct exposure to harsh chemicals



Size	Qty.	Jobber	Order No.
Large	50	\$16.99	PNGL-L
X-Large	50	16.99	PNGL-XL

Shrink Wrap

- Easy-to-use
- High-clarity film
- Keep machined surfaces clean
- Protects from dirt, dust and moisture
- No need to stock several bag sizes

Size	Jobber	Order No.
5' x 1000' w/ Extended Core	\$14.99	SW-5
18' x 1500' with 3" core	36.99	SW-18



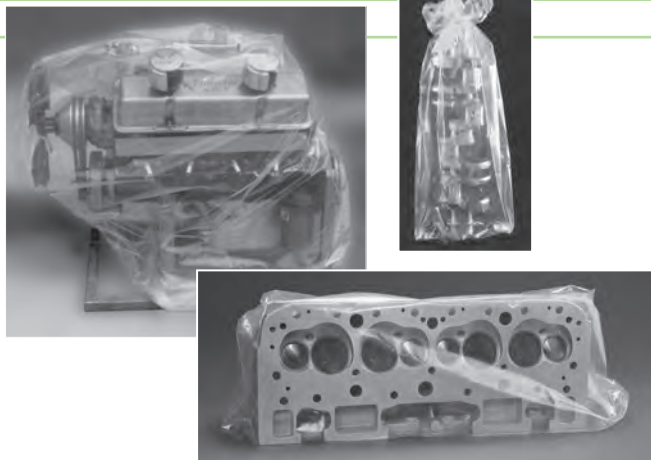

Engine & Parts Storage Bags

- Rugged, 3-mil thickness resists tearing
- Engine bags feature 4-mil thickness for extra strength
- Protects your professional work
- Waterproof • Protect finished work from damage • 4 sizes fit most common rebuilt assemblies • Jumbo engine bags are extra-strong and big enough to accommodate complete engines • Jumbo head bags fit the largest cylinder heads
- Ideal for storing heads, cranks, blocks, etc.

Size	Description	Quantity	Jobber	Order No.
16" x 37"	Heads, cranks, misc.	box of 100	\$ 64.99	BC-15
17" x 44"	Jumbo head bag	roll of 100	72.99	BC-17
27" x 18" x 36"	Box-style for blocks	box of 50	69.99	BE-20
44" x 52"	Jumbo engine bag	roll of 50	133.99	BE-44



Concentrated Hot Tank Detergent Powders For Cast Iron

- Strong alkaline • pH 12.8
 - Removes dirt, heavy oil, grease, carbon, light rust and paint
 - Mix ratio 1/2 lb. powder to 1 gal. of water
 - 25 lbs.
 - Order No. **D-CI25** Jobber \$108.99
- Hazardous Goods Fees Apply



Micro Biostat

- Controls bacteria and fungus in coolant reservoirs
- Treat at 1 oz. per 5 gallons of capacity
- Operate machine for 30 minutes then empty the reservoir
- Refill with coolant and treat 1 oz. per 10 gallons
- Re-treat every 10 days to 2 weeks as needed so it can't happen again
- 20 oz. / 591.5mL bottle
- Order No. **GBP-20** Jobber \$41.99



Defoaming Agent Stops Foaming In Coolants

- For jet washers, air-agitated hot tanks and coolant sumps
- Highly concentrated – start with 1 ounce in 50 gallons

Size	Jobber	Order No.
8 oz. / 236.6mL	\$11.79	D-FOAM-10
1 gallon / 3.78L	34.79	D-FOAM-128

Pro Jet Spray Cleaning Powder

- Heavy-duty • Non-caustic
 - Penetrates to emulsify encrusted dirt, grease and oil on cast iron & aluminum
 - Won't foam excessively
 - Additives prevent scale build-up in jet spray components
 - Use to maximum 165° F/ 73.9° C
 - Mix ratio: 4 oz. powder to 1 gallon of water • pH: 12
 - 50 lb. / 22.68 kg pail
 - Order No. **PJS-50** Jobber \$137.29
- Hazardous Goods Fees Apply



Concentrated Hot Tank Detergent Powders For Non-Ferrous Parts

- Safe on aluminum & sensitive metals, rubber & plastic parts
 - Removes heavy grease and oil
 - 50 lb. pail • pH: 12.85
 - Mix ratio: 1/4 lb. powder to 1 gallon of water
 - Order No. **D-AL50** Jobber \$141.99
- Hazardous Goods Fees Apply

pH Test Strips

- Easy to use • 100 tests per package
- Use the handy guide on the box to determine pH between 0 and 14
- Order No. **HT-PH** Jobber \$43.29

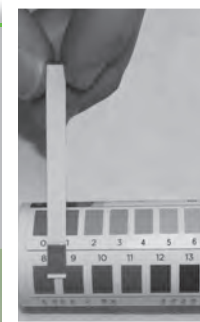

tech tips

from the techxperts™

Pay attention to the mix ratio on cleaning products!

It's important that you start mixing on the weak side and work your way up. An overly strong concentration is just as ineffective as an overly weak mixture. Use pH Test Strips to check the concentration.

CYLINDER HEAD
REBUILDING

CLEANING,
ASSEMBLY & SAFETY

SHORT BLOCK
REBUILDING

CRANKSHAFT/
FLYWHEEL GRINDING

MISCELLANEOUS
TOOLS & SUPPLIES

BRAKE SERVICE
TOOLING

MEASURING
TOOLS

V-TWIN & METRIC
HARD PARTS

Goodson exclusive

Connect the Water
Connect the Air
Select a Brush
You're Set to Clean

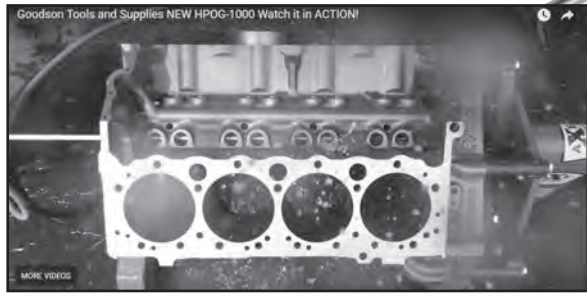

Watch the YouTube Video to see the HPOG in action!



Scan the code to go directly to the Video or Visit YouTube and search for "Goodson HPOG-1000"

Ergonomically designed grip made of billet aluminum

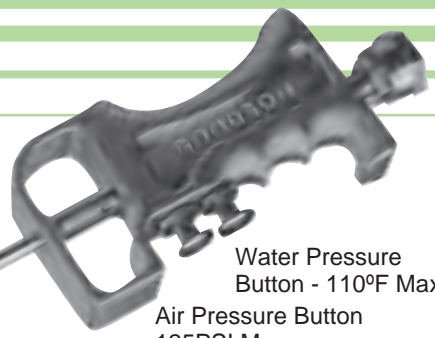

Water Pressure Button - 110°F Max
Air Pressure Button 125PSI Max

Stainless Steel wand will not corrode

Threaded to make brush changes quick and easy

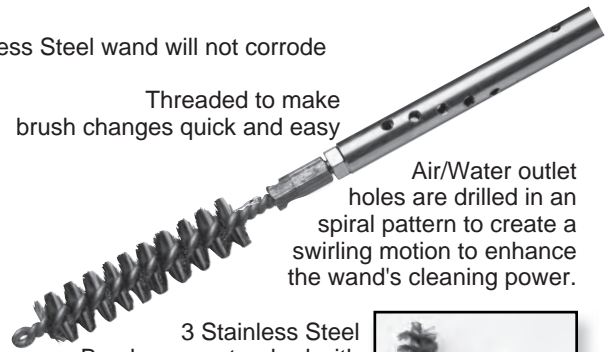

Air/Water outlet holes are drilled in a spiral pattern to create a swirling motion to enhance the wand's cleaning power.

3 Stainless Steel Brushes are standard with this kit — 5/8", 1/2" & 3/8"



High Pressure Oil Gallery (& More) Cleaning System

Aggressively clean oil galleries, lifter bores, cam bearing bores, main bores and cylinder bores — Gas to Diesel, Stock to High-Performance

- Ergonomically designed handle
- Incorporates the aggressive cleaning action of a stainless steel or nylon brush with the hydro action of a specially designed water manifold to be used in conjunction with your shop air to quickly and easily clean the oil gallery holes in gas and diesel engines
- Standard Kit includes a 36"L cleaning wand with pistol grip air/water manifold and 3 brushes (3/8", 1/2" & 5/8" dia.) • 110°F max water temp.

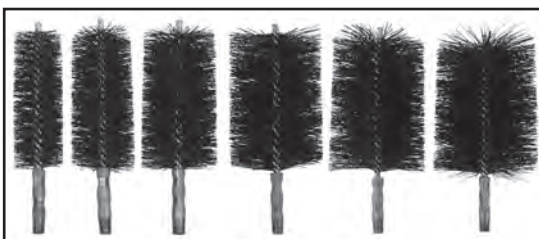
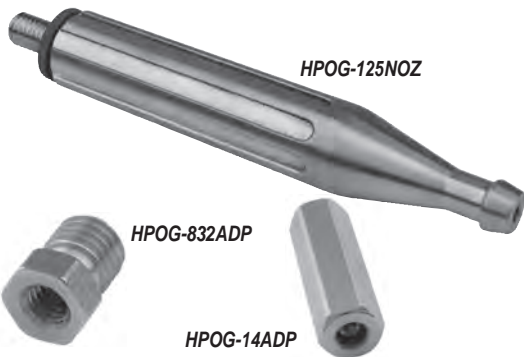

Description	Jobber	Order No.	Incl.
Standard Kit	\$329.99	HPOG-1000	▼
36" Cleaning Wand	59.99	HPOG-W36	x
18" Cleaning Wand (optional)	49.99	HPOG-W18	
3/8" Stainless Steel Cleaning Brush	9.99	HPOG-375	x
1/2" Stainless Steel Cleaning Brush	9.99	HPOG-500	x
5/8" Stainless Steel Cleaning Brush	9.99	HPOG-625	x
3/8" Nylon Cleaning Brush w/ 8-32 thread	7.99	HPOG-625N	
1/2" Nylon Cleaning Brush w/ 8-32 thread	7.99	HPOG-500N	
5/8" Nylon Cleaning Brush w/ 8-32 thread	7.99	HPOG-625N	
3/4" Nylon Cleaning Brush w/ 8-32 thread	7.99	HPOG-750N	
13/16" Nylon Cleaning Brush w/ 8-32 thread	7.99	HPOG-812N	
7/8" Nylon Cleaning Brush w/ 8-32 thread	7.99	HPOG-875N	
1" Nylon Cleaning Brush w/ 8-32 thread	7.99	HPOG-100N	
1 1/4" Nylon Cleaning Brush w/ 8-32 thread	7.99	HPOG-1125N	
8-32 Thread Adaptor	29.99	HPOG-832ADP	
2" Nylon Cleaning Brush w/ 1/4" pipe thread	29.99	HPOG-2000N	
2 1/4" Nylon Cleaning Brush w/ 1/4" pipe thread	29.99	HPOG-2250N	
2 1/2" Nylon Cleaning Brush w/ 1/4" pipe thread	29.99	HPOG-2500N	
3" Nylon Cleaning Brush w/ 1/4" pipe thread	29.99	HPOG-3000N	
3 1/2" Nylon Cleaning Brush w/ 1/4" pipe thread	29.99	HPOG-3500N	
4" Nylon Cleaning Brush w/ 1/4" pipe thread	29.99	HPOG-4000N	
4 1/2" Nylon Cleaning Brush w/ 1/4" pipe thread	29.99	HPOG-4500N	
5" Nylon Cleaning Brush w/ 1/4" pipe thread	29.99	HPOG-5000N	
1/4" Pipe Thread Adaptor	39.99	HPOG-14ADP	
1/4" Spray Nozzle	69.99	HPOG-125NOZ	

CYLINDER HEAD
REBUILDING

CLEANING,
ASSEMBLY & SAFETY

SHORT BLOCK
REBUILDING

CRANKSHAFT/
FLYWHEEL GRINDING

MISCELLANEOUS
TOOLS & SUPPLIES

BRAKE SERVICE
TOOLING

MEASURING
TOOLS

V-TWIN & METRIC
HARD PARTS

Parts Cleaning

Table Top Ultrasonic Cleaning Machines

Ultrasonic cleaning is extremely effective at removing dirt and grime—even in the smallest of crevices. Normally, this would require tedious hand cleaning. Ultrasonic tabletop cleaning machines are ideal for cleaning a wide variety of instruments and mechanical parts; engine and electrical components; jewelry; and other items.

These ultrasonic tabletop cleaning machines return your parts to an almost “like new” condition without damaging delicate parts or surfaces. It’s high-performance cleaning that cleans your parts faster and cheaper than the alternatives.

Choose from the accessories listed below or call **Goodson** at **1-800-533-8010** for information on additional Ultrasonic Machine sizes.



ULTRA 1300M (USC-1300M)

ULTRA 2000M (USC-2000M)

	Ultra 1300M (USC-1300M)	Ultra 2000M (USC-2000M)
Capacity:	3.6 gallons (13.63 liters)	6 gallons (22.71 liters)
Tank Dimensions:	12.75"L x 11.5"W x 5"D 324 x 292 x 127mm	19.5"L x 11.6"W x 7"D 495 x 295 x 178mm
Working Depth:	5"D (130mm)	7"D (178mm)
Machine Dimensions:	14"L x 13"W x 13"H 355 x 330 x 330mm	21"L x 13"W x 15"H 533 x 330 x 381mm
Basket Dimensions:	11.5"L x 10.5"W x 4"H 292 x 266 x 101mm	18"L x 11"W x 4.75"H 457 x 279 x 121mm
Controls:	Manual	Manual
Ultrasonic Frequency:	33/40 kHz Sweeping	33/40 kHz Sweeping
Ultrasonic Power:	200 Watts	400 Watts
Heaters:	300 Watts	500 Watts
Electric:	120V @ 5 Amps or EU 220V	120V @ 7.5 Amps or EU 220V
Order No.	USC-1300M	USC-2000M
Jobber:	\$899.99	\$1499.99

Now 3 Formulas



Ultrasonic Detergents

- Safe for ferrous metals & aluminum
- Medium Duty can be used on plastic
- For ultrasonic immersion tanks
- Medium Duty includes rust preventive
- 5 gallons / 18.39L containers

Formula	Mix Ratio	Uses	Jobber	Order No
water : detergent				
Medium Duty	1:20	Metals, Plastics	\$131.99	USD-MD50
Heavy Duty	1:10	Metals, Aluminum	113.99	USD-HD50*
Caustic	1:10	Cast Iron Only	99.99	USD-CD50*

*Hazardous Goods Fees Apply

Ultrasonic Cleaning Accessories

- Ensure your ultrasonic cleaning machine performs at its peak and delivers the clean your customers demand
- **String Micron Filters**
- Available in 2 filtrations - 50 and 125 Microns
- Measure 2.5" dia. x 10"L and will fit all standard 10" filter housing units
- High structural strength to stand up to severe operating conditions

String Micron Filters (2½" x 10"L)

Filtration	Jobber	Order No.
125 microns	\$15.99	USCF-125
50 microns	15.99	USCF-50S

• Oil Absorbent Tube

- Measure approximately 3" dia. x 14"L
- Use to absorb and remove excess oil from your Ultrasonic Cleaning Machine
- Replace every 4 to 12 weeks as required
- Order No. **OA-1-SM** Jobber \$14.99

• Cartridge Filters

- Measure 2⅞" x 9"L
- 2 filtration levels - 30 and 50 Microns
- Cartridge Filters will **not** fit Tabletop Ultrasonic Cleaners above

Cartridge Filters (2⅞" x 9"L)

Filtration	Jobber	Order No.
30 microns	\$14.99	USF-30
50 microns	14.99	USF-50

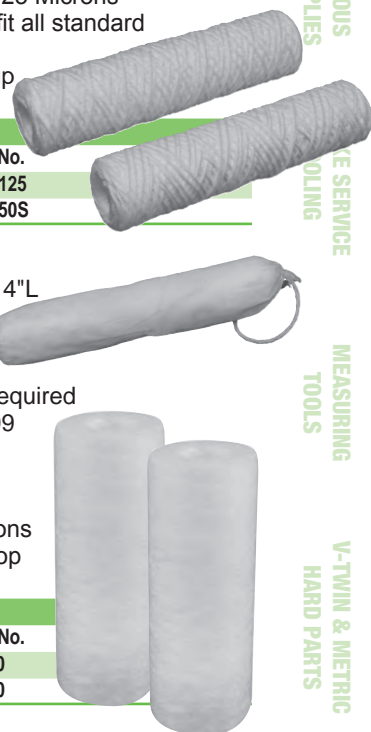

CYLINDER HEAD REBUILDING
CLEANING, ASSEMBLY & SAFETY
SHORT BLOCK REBUILDING
CRANKSHAFT/ FLYWHEEL GRINDING
MISCELLANEOUS TOOLS & SUPPLIES
SERVICE TOOLING
MEASURING TOOLS
V-TWIN & METRIC HARD PARTS

Last Blast & Hi-Temp Last Blast



The more you buy, the more you save

Order a case of 12 and save 10% off jobber
Mix and match colors to make a case.



Last Blast Spray Paint

- Quick-dry formula lets you handle parts in minutes
- Pigment won't smudge
- Resists abrasion, corrosion and most solvents
- Paint heads, blocks and parts just like OE
- Withstands heat up to 250°F/121.1°C
- 12 oz. cans
- **Last Blast** restores a "fresh from the bead-blaster" look to all types of cast iron
- **Aluminum Last Blast** makes aluminum heads and parts look new
- **Color Last Blast** in popular, factory colors
- Aerosol*

Color	Jobber	Order No.
Cast Iron Gray	\$6.99	LB-1*
Aluminum Gray	6.99	ALB-1*
GM Black (Gloss)	7.49	CLB-58*
Ford/Chrys. Red	5.49	CLB-59**
Ford Blue	7.49	CLB-60*
Chevy Orange	7.49	CLB-61*

*Hazardous Goods Fees Apply When Shipped By Air
**Limited to stock on hand



Hi-Temp Last Blast



- Hard, chemical-resistant finish
- Withstands continuous heat up to 1200°F/648.9°C
- Won't deteriorate like ordinary paints
- For blocks, manifolds or any external parts subjected to high heat
- Dries tack-free in 10 min., then heat at 450°F/232.2°C for 1 hour to create a professional, durable finish
- Aerosol*

Color	Jobber	Order No.
Cast Iron Gray	\$7.99	LB-1-HT*
Aluminum Gray	7.99	ALB-1-HT*
Black (Matte)	7.99	CLB-58-HT*

*Hazardous Goods Fees Apply When Shipped By Air



Metal Markers

- No shaking needed
- Quick drying
- Withstands oil, grease and surface contact
- Won't lose its brilliance or legibility



Color	Order No.
Orange	MM-STD
Black	MM-010
Yellow	MM-030
White	MM-050
Green	MM-060
Red	MM-070
Blue	MM-080

Jobber \$6.99

Buy 5, (any combination) save 10% off jobber



High-Performance Hylomar® Gasket Maker & Thread Sealer



- Maintains seal integrity up to 600°F / 315.5°C
- Polyol-based compound turns from a gel into flexible putty within minutes of application
- Non-hardening formula is impervious to oil, gasoline, glycol and other engine fluids
- Oxygen-sensor safe
- Seals gaps .01" or less
- 100 gram tube
- Order No. **HBS-1**
Jobber \$22.99



2" Dispensing Pliers for Flexible Tubes

- Maximizes the use of all the material in the tube due to its effective means of application
- Dispenses the thickest sealant through a very small opening, permitting better application control
- Reduces both cleanup time and the possibility of skin contact or other problems caused by excess material squeeze-out
- Order No. **EB-416** Jobber \$19.99



Lint-Free Disposable Assembly Wipes

- Snow-white
- Shows dirt easily
- Pop-up box
- 9" x 17"
- Ideal for a multitude of uses at the shop, at the track, even at home!
- 220 per box • Order No. **AW-250** Jobber \$25.99



Buy 12 or more and SAVE 10% off jobber!



Press Fit Lube

- A light coat eases press fit
- Ideal for valve guides, piston pins, cylinder sleeves, etc.
- Eliminates the scoring, gouging and galling of parts during press fitting
- 6 oz. / 177.4mL • Aerosol*
- Order No. **PFL-200** Jobber \$12.99

*Hazardous Goods Fees Apply When Shipped By Air



First Lube Engine Assembly Lube

- Prevent dry engine start-ups after long-term storage
- Contains Zinc and Moly
- Clings and forms a slick wall between moving parts
- Withstands start-up pressure
- Compatible with all motor oils

Size	Jobber	Order No.
8 oz. / 236.6mL	\$ 6.99	FL-10
1 gallon / 3.78L	37.99	FL-128



CYLINDER HEAD
REBUILDING

CLEANING,
ASSEMBLY & SAFETY



Press Fit Lubricant

- A light coat eases assembly
- Multiple applications
- Eliminates scoring, gouging and galling of parts during press fitting

Description	Jobber	Order No.
Aerosol 7 oz. / 207 mL	\$18.06	B-200*
Brush Applicator 200 mL	24.59	B-200L

*Hazardous Goods Fees Apply When Shipped By Air



Cam-Shield® Camshaft Assembly Paste

- Provides anti-wear protection for camshafts during break-in
- 2500 parts per million of Zinc
- Use with mechanical and hydraulic camshafts & lifters
- For racing, street, classic, agricultural, diesel & marine camshafts
- 4 oz. / 118.29 mL Brush Top Jar
- Order No. **CSAP-4** Jobber \$18.99



SHORT BLOCK
REBUILDING

CRANKSHAFT/
FLYWHEEL GRINDING



Extreme Pressure Lube

- Withstands pressures up to 50,000 PSI
- Highly refined petroleum product
- Contains no lead, graphite or minerals
- Won't corrode fine surfaces or emulsify with cooling liquids
- Surfaces stay lubed and protected
- In a grease form • 4 fl. oz. / 118.29mL
- Order No. **EPL-4** Jobber \$8.99

Blood Friction Master® Engine Assembly Lube

- Contains a low friction additive (PTFE) for dry start-ups
- Ideal for long-term storage
- Forms a slick wall between moving parts
- Clings until dissolved by oil
- Withstands start-up pressure
- Compatible with all motor oils
- Ideal for high performance

Size	Jobber	Order No.
8 oz./236.6 mL w/brush	\$ 13.99	AL-22-8
1 gal./3.78 L w/pump	133.99	AL-22-10



MISCELLANEOUS
TOOLS & SUPPLIES

BRAKE SERVICE
TOOLING

Universal Gel Lube

- Sprays on as a liquid and forms into a gel within seconds
- Penetrating formula blends with motor oil
- Multiple uses, including cams, lifters, rocker arms, bearings, pistons/wrist pins, cylinders, etc.
- Provides lubrication for engines subjected to prolonged storage before initial start-up
- Aerosol*
- Order No. **GL-8U** Jobber \$18.99

*Hazardous Goods Fees Will Apply if Shipped By Air



Spray Assembly Lube

- Ideal for prelubricating parts to ease assembly
- Eliminates critical initial run-in of new and rebuilt high-performance engine components
- Spray on bearings, crankshafts, pistons, rings, etc.
- Aerosol* • Order No. **SAL-11** Jobber \$14.99

*Hazardous Goods Fees Apply If Shipped By Air



MEASURING
TOOLS

V-TWIN & METRIC
HARD PARTS

CYLINDER HEAD REBUILDING
CLEANING, ASSEMBLY & SAFETY
SHORT BLOCK REBUILDING
CRANKSHAFT/ FLYWHEEL GRINDING
MISCELLANEOUS TOOLS & SUPPLIES
BRAKE SERVICE TOOLING
MEASURING TOOLS
V-TWIN & METRIC HARD PARTS

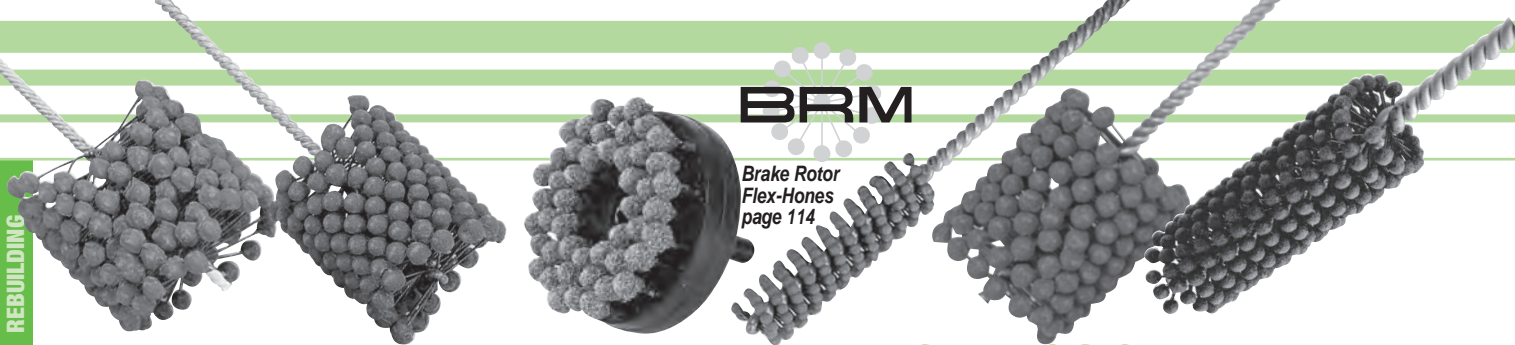

Flex-Hones® For Any Type And Size Of Cylinder

- Abrasive globules each have independent suspension • Self-centering • Self-aligning • Self-compensating for wear
- Applications are interchangeable, select bore size • Right Hand rotation only

240 Grit Silicon-Carbide Valve Guide Flex-Hones®

- Ideal for all materials including cast iron, bronze, phosphor bronze and aluminum

Size	mm	OAL	Jobber	Order No.	Incl.
6 Pc. Kit \$84.99 VG-FKIT ▼					
1 ¹ / ₆₄ "	4.5	6"	21.99	VG-F-4.5MM	
1 ³ / ₆₄ "	5.0	8"	21.99	VG-F-5MM	
1 ¹ / ₃₂ "	5.5	8"	21.99	VG-F-5.5MM	
1 ¹ / ₄ "	6.4	8"	21.99	VG-F-6.4MM	x
9 ³ / ₃₂ "	7.0	8"	21.99	VG-F-7MM	x
5 ¹ / ₁₆ "	8.0	8"	21.99	VG-F-8MM	x
1 ¹ / ₃₂ "	9.0	8"	21.99	VG-F-9MM	x
3 ¹ / ₈ "	10.0	8"	21.99	VG-F-10MM	x
7 ¹ / ₁₆ "	11.0	8"	21.99	VG-F-11MM	x
1 ⁵ / ₃₂ "	12.0	8"	21.99	VG-F-12MM	
3 ³ / ₆₄ "	13.0	8"	21.99	VG-F-13MM	
9 ¹ / ₁₆ "	14.0	8"	21.99	VG-F-14MM	
1 ⁹ / ₃₂ "	15.0	8"	21.99	VG-F-15MM	

400 Grit Diamond Valve Guide Flex-Hones®

- Ideal for heat treated steel, high nickel stainless steel, chromes or plated bores, MMX aluminum alloys, ceramics and carbide

Size	mm	OAL	Jobber	Order No.
1 ¹ / ₄ "	6.4	8"	\$39.99	VGFD-6.4MM
9 ³ / ₃₂ "	7.0	8"	39.99	VGFD-7MM
5 ¹ / ₁₆ "	8.0	8"	39.99	VGFD-8MM
1 ¹ / ₃₂ "	9.0	8"	39.99	VGFD-9MM
3 ¹ / ₈ "	10.0	8"	39.99	VGFD-10MM



Order 3 or more Flex-Hones® (mix & match) and save 10% off jobber

120 Grit Silicon-Carbide Flex-Hones®

- Ideal for all materials including cast iron, bronze, phosphor bronze and aluminum
- When ordering heavy-duty, order on cylinder size

Size	mm	Standard			Heavy-Duty		
		OAL	Jobber	Order No.	OAL	Jobber	Order No.
2"	50.8	8"	\$26.99	BG-210	_____	_____	_____
2 ¹ / ₄ "	57.2	8"	29.99	BG-225	_____	_____	_____
2 ¹ / ₂ "	63.5	8"	31.99	BG-250	_____	_____	_____
2 ³ / ₄ "	69.8	8"	34.99	BG-275	_____	_____	_____
3"	76.2	8"	39.99	BG-300	13 ¹ / ₂ "	\$64.99	BGD-300
3 ¹ / ₄ "	82.6	13 ¹ / ₂ "	44.99	BG-325	13 ¹ / ₂ "	69.99	BGD-325
3 ¹ / ₂ "	88.9	13 ¹ / ₂ "	49.99	BG-350	13 ¹ / ₂ "	71.99	BGD-350
3 ³ / ₄ "	95.3	13 ¹ / ₂ "	54.99	BG-375	13 ¹ / ₂ "	74.99	BGD-375
4"	101.6	_____	_____	_____	13 ¹ / ₂ "	82.99	BGD-400
4 ¹ / ₈ "	104.8	13 ¹ / ₂ "	54.99	BG-418	_____	_____	_____
4 ¹ / ₄ "	107.9	_____	_____	_____	13 ¹ / ₂ "	87.99	BGD-425
4 ³ / ₈ "	111.1	13 ¹ / ₂ "	69.99	BG-438	_____	_____	_____
4 ¹ / ₂ "	114.3	_____	_____	_____	13 ¹ / ₂ "	89.99	BGD-450
4 ⁵ / ₈ "	117.5	13 ¹ / ₂ "	64.99	BG-462	_____	_____	_____
5 ¹ / ₂ "	139.7	_____	_____	_____	17 ¹ / ₂ "	118.99	BGD-550
6"	152.4	_____	_____	_____	17 ¹ / ₂ "	119.99	BGD-600
6 ¹ / ₂ "	165.1	_____	_____	_____	17 ¹ / ₂ "	137.99	BGD-650

Order 3 or more Flex-Hones® (mix & match) and SAVE 10% off jobber

180 Grit Silicon-Carbide Flex-Hones®

- Ideal for all materials including cast iron, bronze, phosphor bronze and aluminum

Size	mm	Standard			Extra-Long Shank		
		OAL	Jobber	Order No.	OAL	Jobber	Order No.
5 ¹ / ₈ "	15.9	8"	\$17.99	BH-625	_____	_____	_____
3 ¹ / ₄ "	19.1	8"	18.99	BH-750	_____	_____	_____
1 ³ / ₁₆ "	20.6	8"	22.99	BH-820	_____	_____	_____
7 ¹ / ₈ "	22.2	8"	18.99	BH-875	_____	_____	_____
1"	25.4	8"	19.99	BH-1000	_____	_____	_____
1 ¹ / ₈ "	28.6	8"	20.99	BH-1125	_____	_____	_____
1 ¹ / ₄ "	31.8	8"	22.99	BH-1250	_____	_____	_____
1 ³ / ₈ "	34.9	8"	23.99	BH-1375	_____	_____	_____
1 ¹ / ₂ "	38.1	8"	24.99	BH-1500	_____	_____	_____
1 ⁵ / ₈ "	41.3	8"	24.99	BH-1625	_____	_____	_____
1 ³ / ₄ "	44.5	8"	25.99	BH-1750	17 ¹ / ₂ "	\$45.99	CBF-175
2"	50.8	8"	26.99	BH-2000	17 ¹ / ₂ "	47.99	CBF-200
2 ¹ / ₄ "	57.2	8"	29.99	BH-2250	17 ¹ / ₂ "	49.99	CBF-225
2 ¹ / ₂ "	63.5	8"	31.99	BH-2500	17 ¹ / ₂ "	54.99	CBF-250
2 ³ / ₄ "	69.8	8"	32.99	BH-2750	17 ¹ / ₂ "	59.99	CBF-275

320 Grit Standard Duty Silicon-Carbide Flex-Hones®

- Ideal for all materials

Size	mm	OAL	Jobber	Order No.
1 ¹ / ₄ "	31.8	8"	\$33.99	BG-125320
2 ¹ / ₄ "	57.2	8"	43.99	BG-225320
3"	76.2	8"	59.99	BG-300320
3 ¹ / ₄ "	82.6	13 ¹ / ₂ "	69.99	BG-325320
3 ¹ / ₂ "	88.9	13 ¹ / ₂ "	74.99	BG-350320
3 ³ / ₄ "	95.3	13 ¹ / ₂ "	79.99	BG-375320
4 ¹ / ₈ "	104.8	13 ¹ / ₂ "	82.99	BG-418320
4 ³ / ₈ "	111.1	13 ¹ / ₂ "	99.99	BG-438320
4 ⁵ / ₈ "	117.5	13 ¹ / ₂ "	99.99	BG-462320

320 Grit Heavy Duty Silicon-Carbide Flex-Hones®

- Ideal for all materials

Size	mm	OAL	Jobber	Order No.
4"	101.6	13 ¹ / ₂ "	\$119.99	BGD-400320
4 ¹ / ₄ "	107.9	13 ¹ / ₂ "	129.99	BGD-425320
4 ¹ / ₂ "	114.3	13 ¹ / ₂ "	134.99	BGD-450320

240 Grit Aluminum-Oxide Flex-Hones®

- Ideal for hard surfaces such as Nicasil and hardened steel

Size	mm	OAL	Jobber	Order No.
2 ¹ / ₄ "	57.2	8"	\$29.99	BA-225240
2 ³ / ₈ "	60.2	8"	38.99	BA-237240
2 ¹ / ₂ "	63.5	8"	37.99	BA-250240
2 ⁵ / ₈ "	69.8	8"	39.99	BA-262240
2 ³ / ₄ "	69.8	8"	39.99	BA-275240
3"	76.2	8"	49.99	BA-300240
3 ¹ / ₄ "	82.6	13 ¹ / ₂ "	57.99	BA-325240
3 ¹ / ₂ "	88.9	13 ¹ / ₂ "	61.99	BA-350240
3 ³ / ₄ "	95.3	13 ¹ / ₂ "	64.99	BA-375240
4 ¹ / ₈ "	104.8	13 ¹ / ₂ "	69.99	BA-418240
4 ⁵ / ₈ "	117.5	13 ¹ / ₂ "	79.99	BA-462240

RIGHT HAND ROTATION ONLY! For best results, always use with an ample flow of honing oil

3-D Fast Cut™

3-D Fast Cut™ Starter Kits	4, 5
Ball Head Drive Adaptors	4, 5
Bounce Springs	4, 5
Bowl Profiler	10
Lift Clip.....	4, 10
Micro Ball Head Tooling	5, 7
Pilots.....	1 - 3, 5
Setting Micrometers.....	5
Tool Setting Fixture	4, 5
Universal Spring Pad Cutters	10
Valve Seat Cutter Blades	6 - 9
Valve Seat Cutter Tool Holder	4, 5
Valve Seat Removal Tooling	5

A

Abrasive Belt Dresser	100
------------------------------------	-----

Abrasives

Aluminum Oxide Cloth Shop Rolls	58, 59
Belts.....	45, 98, 99
Bench Grinder Wheels	105
Blanchard Cylinders	47
Brake Drum Grinding Wheels.....	115
Brake Shoe Grinding Sleeves	114
Cam Grinding Wheels	93
Cartridge Rolls	58, 59
CBN Inserts	44
Chamfering Cones.....	42, 79
Crankshaft Grinding.....	94, 95
Crankshaft Polishing Belts.....	98 - 100
Crocus Cloth	58
Cross Buffs®	58
Cylinder Head Resurfacing.....	44 - 47
Cylinder Honing	76 - 81
Diamond Honing.....	28
Diesel Super Abrasive Insert.....	44
Discs.....	58
Flapwheels	58, 59
Flex-Hones®.....	72, 80, 93, 114
Flywheel	103 - 104
Grinding Discs	58
Grinding Wheels .. 24, 25, 46, 47, 83, 105, 115	
Grinding Stones.....	16, 18, 103, 104
Honing	28, 30, 33, 72, 76 - 83, 91
Hyper-Finish Diamond Honing	28
Lifter Bore Honing.....	91
Mounted Points.....	57
PCD Inserts	44
Rod & Cap Grinding Wheels	83
Rod Honing / Pin Fitting.....	82, 83
Sleeves.....	59, 114
Ultra-Finish Plateau Honing.....	33, 78, 81
Valve Guide Honing.....	28, 30
Valve Refacing	24, 25
Valve Seat	NP-7, 16 - 19

Accu-Turn

Replacement Cutting Tips	111
Replacement Parts	115

Adjustable Coolant Hoses

.....	61
-------	----

Aircraft Seat Grinding Tools

.....	NP-7
-------	------

Air Tools

.....	15, 21, 31, 32, 38, 39, 63
-------	----------------------------

Align Honing	81
All Tool Brake Lathe Replacement Tips...	111
Aluminum Last Blast	70
Alumni-Chek	49
Ammco	
Belts.....	114
Brake Lathe Arbor	113
Brake Lathe Cutting Tips	111
Honing Stone Sets	79
Replacement Parts	110, 113 - 114
Aprons	65, 128
Arbor Nuts	113
Arbors	113
Assembly Lubes	71, 73
Assembly Wipes	66, 70
Aviation Seat Grinding Tools	NP-7

B

Bags	46, 67
Balancing Scales	101
Ball Head Seat Cutter Driver	4, 5
Ball Hones	72, 80, 93, 114
Band Ring Compressors & Expanders	86
Baskets	65, 66
Beehive Springs	122, 127
Beeswax	90
Bean Brake Lathe Replacement Parts	114
Bean Brake Lathe Replacement Tips	111
Bearing Scraper	92
Bell Clamps	116
Belt Dressers	100
Belts	
Black & Decker Valve Refacer Belt	109
Crankshaft Polishing.....	98 - 100
Cylinder Head Resurfacing.....	45
Kwik-Way Valve Refacer Belts	109
Oil Pump Belts.....	82
Rod Honing Belts (for Sunnen).....	82
Sioux Replacement Belts	108
Sunnen® Honing Machine Belts.....	82
Surface Grinding Belts.....	45
Bench Grinder Wheels	105
Bifocal Safety Glasses	57
Black & Decker	
Adaptor for Sioux Stones	20
Belts for Valve Refacer	109
Chuck Belt	109
Replacement Collet	109
Stone Holders & Accessories	20
Valve Refacer Wheels	23, 24
Black Diamond™ Valves	122, 125
Blood Friction Master®	71
Bluing Fluid	11
Bore Gauges and Stands	118, 119
Boring Bar Cutters/Accessories ..NP-5, 74, 75	
Bounce Springs	4, 5, 19, 22
Bowl Profiler Tooling & Blades	10
Brake Drum Grinding Wheels	115
Brake Flex-Hones®	114

Brake Lathe

Arbors.....	113
Bits.....	111
Centering Cones.....	116
Cross Feed Shear Gear	113
Cutting Tips	111
Drum Feed Screws & Bushings.....	113, 115
Dust Boots	114
Feed Motor	113, 115
Flexible Arbor Spacers	113
Lead Screw Bushing.....	114
Locking Knob	113
Mounting Adaptors	116
Replacement Parts	113 - 115
Right Angle Drive Assembly	113
Rotor Feed Screws.....	114, 115
Seals.....	113
Serpentine Drive Belts.....	114
Silencer Bands	112
Spindle Boots	114
Switches	113, 115
Tip Holders	110
Tips.....	111
Wear Inserts	113

Brake Lubes

.....	115
Brake Shoe Grinding Sleeves	114
Brass Shim Stock	54
Brass Wear Inserts	113
Brazed Carbide Cutting Tools	112
Break-In Lubes	71
Bronze Liners & Tooling	34, 35
Bronze Reaming Oil	27, 33, 73
Bronze-Wall®, Bronze-Wall 2® Bushings	33
Brushes ..28, 34, 43, 62, 63, 68, 90, 93, 108, 109	
Burets and Stands	43
Burr Buster	105
Burrs, Carbide	57
Bushing Press Kit	84

C

Calipers	118, 121
Cam-Shield®	71
Camshaft Work	
Cam Bearing Tools	92, 93
Cam Bore Washing Brushes	62, 93
Cam Wheels	93
Flex-Hones®.....	72, 93
Carbide	
Brake Tips	111
Burrs	57
Cutter Blades.....	6-9, 12, 14, 74
Glass Bead Nozzles	64
Pilots	3
Reamers.....	27
Resurfacing Tips.....	45
Rotary Files	57
Sizing Balls	34, 35
Spot Facers / Top Cutters	29
Valve Spring Seat Cutters	42
Cap Grinding Wheels	83
Cartridge Rolls	58, 59

Index

CBN Cutter Inserts	44
CBN Dressing Stick	104
CBN Flywheel Stones	104
CC-ing Equipment	43
Centering Cones, 60°	34
Ceramlub™	115
Chamfer Tools	29, 35
Chamfering Cones	42, 79
Chevrolet	
Block Organizer Tray	60
Conversion Plate	56
Piston Pin Removal Support	85
Clamp-On Brake Lathe Silencer	112
Cleaning Supplies	
Aprons	65, 128
Baskets	65, 66
Brushes	28, 34, 43, 62, 63, 68, 90, 93
Cleaning Media	65
De-foaming Agent	67
Detergents	67
Glass Beads	64
Gloves	64, 65, 88
Parts Tumbler Solution	65
Pro-Jet Spray Cleaning Powder	67
Roloc Bristle Discs	63
Safety Gear	57, 58, 65, 66
Scrapers	63, 92
Shop Towels	66, 70
Sludge Filter Bag	61
Soda Blast	63
Ultrasonic Detergents & Filters	69
Clover Lapping Compound	15
Collets	
Black & Decker	109
Die Grinder	59
Dowel Puller	101
Expanding Pilots	2
Valve Grinding	23
Compression Release Valves	127
Concentricity Gauges	11, 23
Connecting Rod Heaters	88
Coolant Filters	81
Coolant Hoses	61
Coolants, Lubricants & Oils	
All-Purpose Grinding Coolant	73
Aluminum Machining Aid	58
Belt Resurfacer Coolant	45, 73
Blood Friction Master	71
Brake Lubes	115
Bronze Reaming Oil	27, 33, 73
Cam-Shield® Assembly Lube	71
Crank & Cam Grinding Coolant	73, 97
Cutting and Tapping Fluid	11, 56, 73
Cylinder Honing Oil	73, 75, 76, 79
Diamond Honing Oil	28, 73
Extreme Pressure Lube	71
First Lube	71
Flywheel Grinding Coolant	73, 102
Flywheel Grinder Table Lubricant	73
Gasket Maker / Thread Sealer	70
Gel Lube	42, 71
High Performance Resurfacing Spray	44, 73

Coolants, Lubricants & Oils (cont.)	
High Performance Valve Grinding Aid	25, 73
Honing Oil Concentrate	75
Hylomar®	70
Knurlube	33, 73
Lapping Oil	NP-5, 7, 58, 73, 75
Magnetic Crack Detection Oil	49
Micro Biostat	67
Mineral Based Honing Oil	73, 75, 76, 79
Minnesota Fast Freeze	10, 14, 30, 86
Multi-Duty Grinding Coolant	73
Petroleum Based Rust Prevention	61
Porting & Polishing Machining Aid	58
Plate Lube	48
Press Fit Lubricant	10, 30, 71, 86
Pumps	61
Rod Honing Oil	73, 80, 91
Rust Inhibitor for Pressure Tester	53
Rust Proofing Oil	61
Rust Shield	46, 61, 69, 73
Seat Cutting Fluid	13, 73
Spray Assembly Lube	71
Surface Grinding Coolant	47, 73
Tap Oil	53, 73
Titanium Valve Grinding Aid	25, 73
Universal Gel Lube	42, 71
Valve Grinding Oil	25, 73
Valve Seat Machining Aid	11
Way Oil	73
Coolant Magnet	61
Core Drills / Reamers	26
Counterbore Cutters	6-10, 13, 14
Crack Detection and Repair	
Additives	52, 53
Alumni-Chek	49
Applicators	50
Ceramic Motor Seal	53
Engine Seal Tabs	52
Fluid Weld®	52
Goodson Glow	49
Heat Tabs	52
Magnetic Crack Detection Kit	51
Magnetic Crack Detection Oil	49
Magnetic Field Indicator	51
Magnetic Powder	50, 51
Parker Magnetic Crack Detection Unit	50, 51
Powder	50, 51
Repair Kit	53
Seal-All™	52
Small Parts Demagnetizer	51
Threaded Plugs, Irontite®	53
Crankshaft	
Bearing Scraper	92
Crank Grinding Wheels	94, 95
Crank Welding Plug Rods	98
Dial Indicator, Starrett	97, 121
Diamond Dresser Tools	107
Display Inspection Stand	93
Eliptibur Tool	96
Grinding Coolant	73, 97
Hardness Tester	97
Harmonic Dampener Installer	96

Crankshaft (cont.)	
Journal Radius Gauge	97
Peening Tool	97
Plastigage	97
Polishers	100
Polishing Accessories	100
Polishing Belts	98 - 100
Polisher Motor	100
Reluctor Ring Installation Tool	96
Steady Rest Shoes	98
Steel Stamps	98
Stroke Checker	97
Stroker Mimic™	96
Crocus Cloth	58
Cross-Buffs®	58, 59
Cross Feed Dust Boots	114
Cross Feed Shear Gear	113, 114
Cummins Tooling	9, 26, 31
Cutter Drivers & Adaptors	13
Cutting & Tapping Fluid	11, 56, 73
Cylinder Block Work	
Automotive Dowel Puller & Collets	101
Bore Washing Brushes	62, 93
Deck Bridge Combination Tool	122
Lifting Sling	92
Oil Gallery Brushes	62, 90
Oil Gallery Plugs & Tools	90
Pin Pal Puller	101
Cylinder Head CC-ing Equipment	43
Cylinder Head Resurfacing	
Belt Resurfacer Coolant	45, 73
CBN Cutter Inserts	44
Dressers	47
Grind Aid	46, 100
High Performance Resurfacing Spray	45
PCD Inserts for Aluminum	44
Rotary Broach Tool Bit	45
Segments	46
Surfacing Belts	45
Surfacing Wheels	47
Cylinder Honing	
Ammco Stones	79
Chamfering Cones and Mandrels	79
Goodson	76, 77
Honing Oil	73, 75, 76, 79
Keyway Honing Stones	78
Lisle®	79
Nicasil	80
Plateau Honing	78, 81
Portable Cylinder Hones	76
Stones	76 - 81
Sunnen®	75 - 78, 80 - 81
D	
D-Foam	67
Dampener Installer	96
Deburring Tools	87, 105
Deck Bridge Combination Tool	121
Degree Wheel	92
Demagnetizer	51
Depth Gauge, Flywheel	102
Detergents	67

Dial Bore Gauge Setting Fixtures	18, 119
Dial Bore Gauges	118, 119
Dial Calipers	121
Dial Indicators	97, 121
Diamond Dresser Tools	23, 82, 106, 107
Diamond File Set	7
Diamond Flex-Hones®	72
Diamond Guide Hone Tools	28
Diamond Honing Oil	28, 73
Diamond Laps & Accessories	NP-5, 75
Die Grinders	59
Die Grinding Stones	57, 60
Diesel	
Core Drills & Reamers.....	26
Guide Tooling	26 - 35
Heat Tabs	52
Relief Tooling.....	9
Seat Installers	13
Spring Compressor	38
Super Abrasive	44
Valve Guide Tooling	26 - 35
Valve Guides	26, 32
Valve Seals	26, 36
Valve Seat Cutter Blades	6 - 9
Dingleberry Hones	72, 80, 93, 114
Disposable Assembly Wipes	66, 70
DOHC Organizer Tray	60
DOHC Timing Chain Tensioner	75
Double Angle Valve Seat Wheels	18
Dowel Puller & Collets	101
Dressers	
Abrasive Dresser	100
CBN Dressing Stick	104
Cutter Assemblies	47, 102
Diamond Stone Dresser	82
Flywheel Stone Dressers	102
Hand-Held Dressing Sticks	97
Premium Diamond Dressers	23, 106, 107
Resurfacer Grinding Wheel Dressers.....	47
Star Dressers	47, 102
Valve Seat Wheel Dressing Stands.....	22
Drive Adaptors	4, 13
Dykem® Layout Fluid	11
E	
Economy Head Holder	56
Eliptibur Tool	96
Engine Balancing Supplies	101
Engine Cart	60
Engine Pre-Lube Supplies	71, 89
Engine Seal Tabs	52
Epoxy, Porting	59
Expanding Pilots	2
Extended Length Pilots (.375" Top)	3
Extended Length Run-Out Gauge	NP-7
Extreme Pressure Lube	71
F	
False Guides	32, 124
Fast Freeze	10, 14, 30, 86
Feeler Gauges	116

File, Diamond	7
Filter Bag	61
Filter Paper & Mats	80
Filters	
Hone	81
Ultra-Sonic.....	69
First Lube	71
Flapwheels	58, 59
Flex-Hones®	72, 80, 93, 114
Fluid Weld®	52
Flywheel Grinding	
Bolt Adaptors	102
CBN Flywheel Stones	104
Coolant	73, 102
Dowel Puller & Collets	101
Depth Gauge	102
Dressers	102
Grinding Stones	103, 104
Mounting Adaptor	103, 104
Flywheel Step Gauge	102
FMC	
Brake Lathe Replacement Parts.....	114
Brake Lathe Replacement Tips	111
Ford	
Core Drills & Reamers.....	26
Diesel Seat Cutter Blades	9
Smog Plugs	54
Valve Guides	32
Formula One Boring Tools	NP-5
G	
Gas Porting Tools	86
Gasket Maker	70
Gauges	
Concentricity Gauge	23
Crankshaft Journal Radius Gauge	97
Dial Bore Gauges	118, 119
Feeler Gauges.....	116
Flywheel Depth Gauge	102
Magnetic Field Gauge	51
Rod Bolt Stretch Gauge.....	117
Small Hole Gauge Set.....	35, 120
Split Ball Bore Gauge	35, 117
Sunnen AG-Gauge.....	117
Telescoping Gauge Set.....	116
Torque Angle Indicator	55, 93
Vacuum Tester Gauge	108
Valve Seat Height Gauge.....	22, 121
Valve Seat Run-Out Gauges.....	11
Valve Stem Height Gauges	42
Warp Gauges	116
Gel Lube	42, 71
General Motors (GM)	
Head Bolt Clean-Out Taps	53
Oil Pickup Tube Driver.....	90
Reluctor Ring Installation Tool.....	96
Vortec Adaptor Plate Set	54
Glass Beading Supplies	64
Glasses, Safety	57, 58, 97, 101

Gloves	
Glass Bead	64
Heat & Flame Resistant.....	88
Hot Tank Gloves	65
Nitrile	66
Parts Washing Gloves	66
Grind Aid	46, 100
Grinding Stones & Wheels (see Abrasives)	
Guide Installers (Drivers)	31
Guide Knurling	
Knurling Arbors	33
Knurltube	33, 73
OD Knurling Tool.....	33
Guide Liners	35
Guide Shoes	82, 83
Guide Tooling, Diesel	26, 31
Guides	NP-6, 26, 32, 122, 124

H	
Hardness Tester	97
Harley-Davidson® (see V-Twin)	
Harmonic Dampener Installer	96
Head-Bolt Hole Cleaners	53
Head Bolt Spot Facer	29, 56
Head Holders	43, 56
Head Organizer Trays	60
Head Saver Shims	54
Heat Tabs	52
Heavy Metal	101
Height Gauges	22, 42, 121
High Performance	
Cam Wheels	93
CC-ing Equipment	43
Gasket Maker & Thread Sealer	70
Resurfacing Spray	45, 73
Valve Grinding Aid.....	25, 73
Valve Seat Cutter Blades	6 - 9
Valve Spring Booster Shims	43
Valve Spring Compressors	NP-5, 38 - 41
Valve Spring Testers	37
Valve Train Checking Springs	42
High Pressure Oil Gallery Cleaner ..	NP-3, 68
Hi-Temp Last Blast	70
Honda Clone Seat Cutting Kit	5
Honing Oil	73, 75, 76, 79
Honing Stones	
Cylinder Honing.....	76 - 81
Pin Fitting.....	83
Rod Honing.....	82 - 83
Valve Guide	28, 30
Hoses	48, 61
Hot Tank Detergents	67
How-To Manuals & Videos	109
Hylomar® Gasket Maker & Solvent	70
Hyper Finish Diamond Guide Sizing ..	28, 29

Index

I

ID Tags	60
IDL Valve Refacer Wheels	24
Indicators	22, 36, 42, 56, 93, 97, 121, 122
Infinite Flow Cutting Tips (IFT)	6
Instructional Manuals	109
Internal Calipers	118
Iron-tite	52, 53

J

Jet Spray Cleaning Powder	67
Jet Valve Eliminator Kit	53
Jet Washer Parts Baskets	66

K

Keeper-Keeper	41, 65
Keeper Tools	40, 41
Keyway Honing Stones	78
Knurling	33
KO Lee Valve Refacer Wheels	24
Kwik-Way	
Belts	45, 109
Boring Bar Cutters	NP-5, 74, 75
Brake Lathe Tips	111
Core Drills & Reamers	26
Diamond Lap	75
Drive Adaptor	17, 20, 21
Expanding Pilots	2
Heavy Duty Dressing Stand	22
Rebuild Kit for KW Holders	20
Resurfacer Wheel Segments	46
Single-piece Resurfacer Wheels	47
Solid Tapered Pilots	1, 2
Stone Holders	20
Valve Refacer Replacement Parts	109
Valve Refacer Wheels	24
Valve Seat Grinder Motors	17, 21
Valve Seat Stones	16

L

Lap, Diamond	75
Lapping Compound	15
Lapping Oil	58, 73, 75
Lapping Tools & Compound	15
Last Blast Paint	70
Layout Fluid	11
Letter Stamps	98
Levels & Vials	5, 43, 44
Lifter Bore Tools	91
Lifting Sling	92
Lights	
Inspection Lights	105
LED Lights	105
Work Light	105, 113
Liners, Guide	35
Lisle® Honing Stone Sets	79
Litmus Paper	67

Lubricants

Blood Friction Master®	71
Brake Lubes	115
Cam-Shield® Assembly Lube	71
Extreme Pressure Lube	71
First Lube	71
Flywheel Grinder Table Lubricant	73
Press Fit Lube	10, 30, 71, 86
Spray Assembly Lube	54, 71
Universal Gel Lube	42, 55, 71
Way Oil	73

M

Machine Covers	23
Magnetic Bolt Washer Removers	43
Magnetic Crack Detection	49 - 51
Magnetic Strap Silencer	112
Magnetic VAD Holder	54
Magnetic Valve Spring Shim Removers	43
Mallory (Heavy Metal)	101

Mandrels

Align Hone	81
Butterfly Mandrels	58
Cross Buff / Flap Wheel Mandrel	58, 59
Diamond Sizing System	28
Honing	76
Roll Mandrels	58, 59

Manual Ring Grinders

Manual Spring Compressors	NP-5, 40, 41, 126
----------------------------------	-------------------

Manual Vacuum Testers

Manual Valve Guide Drivers	31
-----------------------------------	----

Markers

Markers	60, 70
----------------	--------

Measuring Tools

Bore Gauges	118, 119
Calipers	121
Crankshaft Dial Indicator	97, 121
Dial Indicators	22, 36, 42, 97, 121
Feeler Gauges	116
Flywheel Depth Gauge	102
Micrometers	120
Rod Bolt Stretch Gauges	117
Setting Micrometers	5
Small Hole Gauge Set	35, 120
Straight Edges	116
Stroke Checker	97
Telescoping Gauge Set	116
Valve Seat Height Gauge	22, 121
Valve Seat Run-Out Gauge	11, 120
Valve Stem Concentricity Gauge	23
Valve Stem Height Gauges	42
Warp Alignment Gauge	116

Metal Markers

Metal Markers	70
----------------------	----

Micrometers

Micrometers	120
--------------------	-----

Micro Ball Head Tooling

Micro Ball Head Tooling	5
--------------------------------	---

Micro Biostat

Micro Biostat	67
----------------------	----

Micro Valve Seat Stones

Micro Valve Seat Stones	18
--------------------------------	----

Milwaukee-Eight™ Parts

Milwaukee-Eight™ Parts	122
-------------------------------	-----

Minnesota Fast Freeze

Minnesota Fast Freeze	10, 14, 30, 86
------------------------------	----------------

Mitutoyo®

Dial Bore Gauge	118
Hole Gauge Set	35, 120
Split Ball Bore Gauge	35, 117

Mondello Oldsmobile Manual

Mondello Oldsmobile Manual	NP-5
-----------------------------------	------

Mondello Seat Cutter Blades

Mondello Seat Cutter Blades	6
------------------------------------	---

Motors

Brake Lathe	113, 115
Crankshaft Polisher	100
Seat Grinding	NP-7, 17, 19, 21

Mounted Points

Mounted Points	57, 59
-----------------------	--------

N

Neway

Easy Turn Wrench	13
Pilots	1 - 3
Replacement Cutter Blades & Screws	12
Valve Seat Cutters	NP-4, 12

Nicasil Honing Stones

Nicasil Honing Stones	80
------------------------------	----

Number Stamps

Number Stamps	98
----------------------	----

O

O-Ring Wire

O-Ring Wire	75
--------------------	----

Oil Filter Tools

Oil Filter Tools	90
-------------------------	----

Oil Gallery Brushes

Oil Gallery Brushes	62, 90
----------------------------	--------

Oil Gallery Cleaning System

Oil Gallery Cleaning System	NP-3, 68
------------------------------------	----------

Oil Gallery Tools

Oil Gallery Tools	90
--------------------------	----

Oil Gallery Wax

Oil Gallery Wax	90
------------------------	----

Oil Pre-lube Tank

Oil Pre-lube Tank	89
--------------------------	----

Oil Pump Belts

Oil Pump Belts	82
-----------------------	----

Oil Pump Tools

Oil Pump Tools	90
-----------------------	----

On-The-Engine Spring Compressor

On-The-Engine Spring Compressor	41, 126
--	---------

Organizers

Organizers	60
-------------------	----

Oversize Bronze-Liners

Oversize Bronze-Liners	35
-------------------------------	----

Oversize Valve Guides

Oversize Valve Guides	32, 122, 124
------------------------------	--------------

Oversize Valve Seat Inserts

Oversize Valve Seat Inserts	14, 123
------------------------------------	---------

P

Paint

Last Blast Spray Paint	70
Markers	70

Parts Cleaning

Airless Blaster Media	65
Baskets	66
Brushes	NP-3, 28, 34, 43, 62, 63, 68, 90, 91, 93
Detergent Powders	67
Glass Bead Tools & Supplies	64
Gloves	64, 66, 88
Hydro-Air Gun	63
Keeper-Keeper	41, 65
Parts Tumbler Solution	65
Pro-Jet Spray Cleaning Powder	67
Roloc Bristle Discs	63
Super Scraper™	63
Tumbler Cleaning Media	65
Ultrasonic Cleaning Machines	69
Ultrasonic Detergents & Filters	69
Valve Stem Protectors	65

Parts Storage & Organizers

Baskets	66
DOHC Cylinder Head Tray	60
Engine Cart	60
Keeper-Keeper	41, 65
Organizer Trays	60
Parts Tags & Marker	60
Plastic Bags	46, 67
Safety Pins	60
Shrink Wrap	66

Parts Tumbler Media

Pastelub™ Hi-Temp Brake Lube

Peening Tool

Performance Brake Lathe Tips

Peterson

Boring Bar Cutters	74
Core Drills & Reamers	26
Crankshaft Grinding Wheels	94, 95
Cylinder Head Resurfacing Belts	45
Resurfacer Abrasives	46, 47

pH Test Strips

Pilots

Aircraft	NP-5
Expanding	2
Extended Length Top Solid-Tapered	3
Micro	1, 2, 5
Seat Dresser	22
Serdi-Style (Live)	3
Solid-Tapered Steel	1
Specialty	32, 42
Tapered Carbide	3

Pin Bushing Press Kit

Piston Installing Tools

Deadblow Hammer	86
Electric Rod Heater	88
Gas-Fired Rod Heater	88
Piston Pin Installing Fixture	88, 89
Ring Compressing Pliers	86
Ring Squaring Tools	87
Rod Clamping Vise	89

Piston Pin Removal Fixture

Piston Ring Filers

Plastigage

Plateau Hones

Plugs

Crack Repair	53
Frost Plug Tools	91
Oil Gallery	90
Smog Plugs	54

Pneumatic Tools

Air Hammer	31
Lapping Tool	15
Scraper	63
Valve Guide Drivers	31
Valve Seat Grinder Driver	NP-7, 21
Valve Spring Compressors	38, 39

Polishing Belts & Rouge

Portable Cylinder Hones

Porting & Polishing

Abrasives Kits	59
Aluminum Oxide Cloth Shop Rolls	58
Butterfly Mandrels	58
Crocus Cloth	58
Cross-Buffs®	58
Die Grinders	59
Epoxy	59
Flapwheels	58, 59
Mandrels	58, 59
Mounted Wheels	57
Port Reshaping Kit	59
Porting Kits	59
Porting & Polishing Machining Aid	58
Replacement Abrasives and Mandrels	58
Rotary Files	57

Powered Ring Filer

Pre-Lube Tank

Premium Tapered Reamers

Pre-Oiler

Press Fit Lubricant

Press Kit, Tapered Pin

Pressure Lube

Pressure Tester Rust Inhibitor

Pro Jet Spray Cleaning Powder

Prussian Blue

Pullers

Pumps

R

Radiac Abrasives

Blanchard Cylinder	47
Cam Grinding Wheels	93
CBN Cutters	44
CBN Flywheel Stones	1047
Crankshaft Grinding Wheels	94, 95
Flywheel Grinding Stones	104
PCD Cutters	44
Resurfacing Segments	46
Resurfacing Wheels	47
Valve Refacing Wheels	24, 25

Radial Wire Brushes

Reamers

Bronze	27
Carbide Valve Guide	27
Core	26
Diesel	26
High Speed Steel for Cast Iron	27
Piloted Core Reamers	26
Small Diameter	27
Tapered	105

Reaming Oil

Rebuilding Kits

Spring Compressor	41
Stone Holder	20

Reluctor Ring Installation Tool

Reluctor Rings

Removers

Booster Shim	43
Bronze Liners	35
Cam Bearings	92
Dowel Pin Pullers	101
Keeper	40, 41
Liner Removal Tool Driver	35
Oil Gallery Plugs	90
Piston Pin	85
Piston Rings	86
Stud	55, 56
Tapered Pin Bushings	84
Valve Guide	31
Valve Seat	5, 14
Valve Seat Stone	17, 19, 20
Valve Stem Seal	36
Washer	43

Replacement Belt for B&D Valve Refacer 109

Resurfacing Belts

Resurfacing Coolant

Resurfacing Dressers

Resurfacing Spray

Resurfacing Wheel Segments

Resurfacing Wheels

Right Angle Air Driver

Right Angle Drive Assembly

Ring Band Compressors

Ring Expanders

Ring Grinders

Rocker Arm Tools

Rockwell Hardness Tester

Rod and Cap Grinding Wheels

Rod Balancing Stand

Rod Bolt Boots

Rod Bolt Installing Block

Rod Bolt Stretch Gauge

Rod Clamping Vise

Rod Heaters

Rod Hone Filter Mat

Rod Honing

Rod Honing Oil

Roloc Bristle Discs

Rotary Broach Tool Bits

Rotary Files

Rotor Adaptors

Rotor Silencers

Rottler

Boring Bar Cutters	74
Diamond Lap	75
Sleeve Cutters	74
Valve Refacer Wheels	24

Round Brake Lathe Tips

RTI Brake Lathe Tips

Rust Protection

S

Safety Glasses

Safety Pins

Scales

Scrapers

Screws

Index

Ball Head 4, 5
Boring Bar..... 74
Carbide Cutter 4, 5, 10
Catspaw..... 74
Cross Buff Mandrel..... 58
Feed Screws..... 113 - 115
Neway..... 12
Scribe Tools 11
Seal-All™ 52
Seals 26, 36, 122, 123
Seal Cutters 32, 123
Seal Pullers..... 36
Seal Setters 36, 123
Seat Cutters..... 4 - 10, 12 - 14, 42
Seat Cutting Fluid..... 11, 73
Seat Drivers 13
Seat Grinding (see Valve Seat Grinding)
Seat Removers 5, 14
Segments..... 46
Serdi Style Pilots 3
Serdi-Style Bodies & Drivers 4, 13
Shim Remover 43
Shim Stock 55
Shims 43, 44, 54, 55, 126
Shot
Ceramic & Steel..... 65
Glass 64
Shop Towels 66, 70
Shrink Wrap 66
Silencer Bands, Brake Lathe 112
Silencer Brake Spray 115
Sioux™ Replacement Parts
Belts..... 108
Driver Parts..... 108
Parts Tumbler Rebuild Parts 65
Vacuum Tester Gauge 108
Valve Grinder Parts 108
Valve Refacer Parts..... 108
Wheel Dresser Parts 108
Sioux-Style
Drive Adaptor 20, 21
Drivers 19, 21
Pilots 1 - 3
Stone Holders 19, 20
Vacuum Plates 48, 108
Valve Refacer Wheels 25
Valve Seat Grinding Kit 19
Valve Seat Stone Removers 19, 20
Valve Seat Wheels 18, 19
Sizing Balls..... 34, 35
Sling, Lifting 92
Sludge Filter Bag (Sock)..... 61
Smog Plugs 54
Snap-on
Replacement Brake Lathe Cutting Tips... 111
Valve Refacer Wheels 25
Spark Plug Thread Chaser..... 105
Spindle Boots 114
Split Ball Bore Gauge..... 35, 117
Spot Facers 29, 56
Spray Assembly Lube..... 54, 71

Spring Compressors..... NP-5, 38 - 41, 126
Spring Compressor Rebuild Kit 41
Spring Pad Cutters 10, 42
Spring Testers 37
Stamps, Steel..... 98
Steady Rest Shoes 98, 109
Steel Shim Stock..... 54
Step Gauge 102
Stone Holders..... NP-7, 17, 19, 20
Stones
Camshaft 93
Crankwheel..... 94, 95
Flywheel 103, 104
Honing 76 - 81
Porting & Polishing 57, 59
Refacing 24, 25
Resurfacing 46, 47
Rod Honing..... 82, 83
Valve Seat 16 - 19
Storage Bags 46, 67
Storage Cart 60
Storm-Vulcan
Boring Bar Cutters 74
Crankshaft Grinding Wheels 95
Resurfacers Belts 45
Resurfacers Wheel Segments 46
Resurfacing Carbide Cutter Tips 45
Straight Edges..... 116
Stroker Mimic™..... 96
Stud Extractor 55
Stud Pullers 55
Stud Stretchers 44
Sunnen®
Align Hone Mandrels 81
Belts for Rod Honing Machines 82
Cap Grinding Wheels 83
Coolants 75, 76
Core Drills & Reamers 26
CV-616 Honing Machine Parts 82
Cylinder Honing Stones 76 - 81
Dial Bore Gauges 119
Guide Shoes 82, 83
Lifter Bore Hones 91
Main Bore Align Hone Mandrels 81
Mandrel Drivers 81, 82
Master Holder & Stone Supports..... 77
Oil Pump Belts 82
Plateau Honing Tools, Ultra-Finish 78
Portable Cylinder Hones 76
Press-Fit Lubricant 30, 71, 86
Replacement Parts for CV-616 82
Rod Honing Machine Belts 82
Rod Honing Stones & Guide Shoes .. 82, 83
Silicon Compound (AN-30)..... 81
Truing Sleeves..... 30, 91
Valve Guide Hone Set 30
Valve Refacer Steady Rest Shoes 109
Valve Refacer Wheels 25
Super Scrapper™..... 63

Surfacing
Belts..... 45
CBN Inserts 44
Coolants 45, 47, 73
PCD Inserts 44
Segments 46
Wheels..... 47
Swedge Cutting Tool..... 114
Switches 108, 109, 113

T

Tap, Clean-Out..... 53
Tapered Pin Bushing Kit..... 84
Tapered Reamers 105
Tapping Fluid 53, 73
Taps
Crack Repair..... 53
Head Bolt..... 53
Telescoping Gauge Set..... 116
Temperature Indicator Crayons 88
Tensioner Stop Block 75
Thin Wall Bronze Liners..... 35
Thread Chaser 105
Timing Chain Tensioner..... 75
Tip Holders, Brake Lathe 110
Titanium Coated Cutting Tips..... 111
Tooling Stands 20, 42
Top Cutters..... 29, 56
Torque-Angle Indicator 55, 93
Trays, Organizing..... 60
Tumbling Media 65

U

Ultra-Finish Plateau Honing Tools 33, 78, 81
Ultrasonic Detergents & Filters 69
Universal Checking Standards..... 120
Universal Dressing Stand 22
Universal Gel Lube..... 42, 71
Universal Head Holder 43, 56
Universal Spring Pad Cutter..... 10
Utility Rolls 58

V

V-Twin

Hard Parts NP-6, 122 - 127
On-the-Engine Spring Compressor ... 41, 126
Valve Guides 122, 124
Valve Seals..... 122, 123
Valve Seat Inserts 14, 123
Valve Spring Compressors..... 41, 126
Valve Springs 122, 126, 127
Valves NP-6, 122, 125
Vacuum Plates..... 48, 108
Vacuum Testers 48
Valve Grinding
Adaptor for ½" Chucks NP-5, 23
Black & Decker Valve Refacer Collets 109
Diamond Dresser Tools..... 23, 107
Dresser Pilots 22
Machine Parts..... 108, 109

Valve Grinding (cont.)

Valve Grinding Aid	25, 73
Valve Grinding Oil	25, 73
Valve Refacer Wheels	24, 25
Valve Stem Concentricity Gauge	23

Valve Guide

Bronze-Liners	34, 35
Bronze-Wall® & Bronze-Wall 2®	33
Brushes	28, 62
Core Drill / Reamer	26
Diamond Hone Set	28
Drivers	31
Flex-Hones®	72
Gauge Set	35, 117, 120
Guides	32, 122, 124
Hone Set	28, 30
Knurling Tools	33
OD Chamfer Tool	29
OD Knurling Tool	33
Plateau Hones	33
Reamers	27
Small Hole Gauge Set	35, 120
Spot Facer	29, 56
Top Collars	29
Top Cutters	29, 56
Valve Guide Brushes	28, 62
Valve Guides	32, 122, 124
Valve Lapping Tools & Supplies	15
Valve Refacing Wheels	24, 25
Valve Seal Drivers	123
Valve Seal Pullers	36
Valve Seal Setter	123
Valve Seals	26, 36, 122, 123

Valve Seat

Aircraft Seat Grinding Kit	NP-7
Basic Valve Seat Grinding Kits	17, 19
Bounce Springs	4, 5, 19, 20, 22
Cutter Blades	6 - 10, 12
Cutter Drivers	4, 5, 13
Cutting Fluid	13, 73
Cutting System	4, 5, 10, 12
Dressers	22, 107
Drivers	13
Inserts	14, 123
Layout Fluids	11
Machining Aid	11
Minnesota Fast Freeze	10, 14, 30, 86
Neway Seat Cutting System	12, 13
Nickel-Chrome Valve Seats	14
Removers	5, 14
Run-Out Gauges	11, 120
Stone Holders	NP-7, 17, 19, 20
Valve & Seat Scribe	11
Valve Seat Cutter Blades	6 - 9, 12
Valve Seat Counterbore Cutters	13, 14
Valve Seat Grinding	NP-7, 16 - 22
Valve Seat Insert Driver	13
Valve Seat Wheels	16 - 19
Valve Spring	
Adaptors	38 - 41
Booster Shims	43
Calibrated Springs	36
Compressors	38 - 41, 126
Inserts	43
Keeper Installation Tools	40, 41
Manual Valve Spring Bench	39
Pneumatic Valve Spring Press	38

Valve Spring (cont.)

Rebuild Kit	41
Seat Cutters	42
Spring & Retainer Kits	122, 126, 127
Valve Spring Inserts	43
Valve Spring Shim Remover	43
Valve Spring Testers	37
Valve Stem	
Concentricity Gauge	23
Dial Indicated Valve Stem Height Gauge ...	42
Protectors	65
Valve Stem Oil Seals	26, 36, 122, 123
Valves	NP-6, 122, 125
Van Norman	
Boring Bar Cutters & Parts	74, 75
Core Drills & Reamers	26
Crankshaft Grinding Wheels	95
Flywheel Cutter	102
Resurfacers Segments	46
Single-piece Resurfacers Wheels	47
Valve Refacer Wheels	25
Vials	43, 44
Vortec Tools	55

W

Warp Gauge	116
Water Based Honing Coolant	75
Way Oil	73
Wear Sleeves	13
Welding Rods	98
Wire Wheels & Brushes	62, 63
Wrist Pin Bushing Press Kit	84

California Proposition 65



WARNING: Cancer and Reproductive Harm -
www.P65Warnings.ca.gov

“Proposition 65 requires businesses to provide warnings to Californians about significant exposures to chemicals that cause cancer, birth defects or other reproductive harm.”

Due to recent regulatory changes in California, we must now warn you that many of the products commonly used to manufacture our products contain chemicals known to the state of California to cause cancer and reproductive harm.

A complete list of materials requiring the Prop 65 warning can be found at <https://www.p65warnings.ca.gov>.

WARNING: Operating, servicing and maintaining a passenger vehicle or off-road vehicle can expose you to chemicals including engine exhaust, carbon monoxide, phthalates, and lead, which are known to the State of California to cause cancer and birth defects or other

reproductive harm. To minimize exposure, avoid breathing exhaust, do not idle the engine except as necessary, service your vehicle in a well-ventilated area and wear gloves or wash your hands frequently when servicing your vehicle. For more information go to www.P65Warnings.ca.gov/products/passenger-vehicle.

If you need additional information about any specific products sold by Goodson, please check our website or contact the Goodson Techxperts for details.
Call 1-800-533-8010.

Policies

Pricing:

Prices are subject to change without notice. There is no minimum order. Orders are billed at the prices in effect at the time of shipping. Discounts are not available on Sunnen® products.

Shipping:

Goodson ships orders the same day they are received. Orders received after hours, on weekends or holidays are shipped the next business day. You have several choices of shipping speed. Cost of shipping is based on total weight or package dimensions and the distance from our warehouse. Many changes have recently been implemented by shipping companies. Goodson is working with these companies to ensure you receive your orders promptly without additional cost.

■ **STANDARD:** Unless otherwise requested, we ship items up to 150 lbs. and up to 130" in combined width, length and height by US Postal Service, UPS or FedEx services. Items over the weight or size limit must go by common carrier.

■ **EXPRESS:** We can ship most items by air to arrive in your choice of 1, 2 or 3 days. Please note that Goodson is not responsible for weather related delays.

Upon receipt of your order, please inspect all cartons immediately for damaged or missing products before signing for the merchandise. Any packages received in a damaged condition should be rejected and/or noted at the time of receipt. The customer assumes all risk of lost or damaged products in transit and likewise, assumes responsibility for filing a claim with the carrier. Any damage must be reported within 5 days of receipt (delays in reporting damage will prevent the carrier from accepting responsibility for damage and you will then be held responsible for the merchandise). Goodson will assist you in any way we can to help with your claim to the carrier.

In the event that items are missing from your shipment, please contact Goodson within 3 business days. Contact Goodson at **1-800-533-8010**.

Freight:

For orders shipped ground within the USA, you may deduct the freight charges on any **JOBBER** net invoice of **\$800** or more if you pay within 30 days (including Internet orders). However, Glass Beads, Steel Shot, Tumbler Media, Machines, Equipment, Bulk Liquids and Crankwheels are not included (shipped F.O.B. Winona, MN). Hazardous Materials, Dangerous Goods and Dimensional Shipping fees may apply on certain items. Please call to inquire.

Terms:

- 1) A 1% discount is given on merchandise if payment is made within 15 days from invoice date. This discount applies to the merchandise amount only (not the total amount) on the invoice (not a statement). The discount amount is shown in the lower left hand corner of the invoice. This discount does not apply to statement payments and does not apply to credit card orders.
- 2) Invoices not paid in full within 30 days from the statement date are subject to a finance charge of 1.5% per month (18% per year).

Credit & Debit Card Orders:

Goodson accepts MasterCard, Visa, American Express and Discover Card. For your security, credit card numbers are NOT kept on file. Credit card orders do not qualify for the 1% quick-pay discount.



Check Acceptance:

In the unlikely event that your check is returned for insufficient or held funds, we will debit your checking account electronically for the face amount of the check plus the service fee allowed by your state's law. This allows us to resolve the problem without turning you over to a collection agency and harming your credit rating. The transaction will appear on your bank statement and no one will have to contact you about payment.

Returns:

You may return any item, **except special orders**, within 60 days. We will do our best to correct any problems or to send a replacement. If an item was damaged through mis-use or modification, Goodson will not accept it as a return. Credits will only be issued after it is determined that the part is resellable or it is deemed defective.

To return an item, please follow these easy steps:

1. Enclose a note explaining why you're returning the product. Be sure to include your name and account number (you'll find this on your invoice)
2. Ship the item freight prepaid within 60 days from invoice date to
Goodson Tools & Supplies for Engine Builders
ATTN: Returns
156 Galewski Drive
Winona, MN 55987

For best results, please ship return merchandise by a trackable shipping method. Keep your receipt as it may be necessary to track the package if it is lost in transit. A 10% restocking fee applies on all returns unless the problem was the fault of Goodson. If so, the restocking fee is waived and shipping costs are reimbursed.

ABRASIVES WARRANTY: Abrasives have a shelf-life, therefore, all abrasives are warranted against manufacturing defects for 1 year from the date of original purchase.

Privacy Policy:

All information that Goodson collects from its customers through purchases, credit applications or other transactions is kept private and is not disclosed to anyone except as permitted or required by law. Goodson will not sell or trade this information to anyone. Goodson will limit employee access to customers' private information to only those employees who need to know the information to provide products and services to you. Goodson maintains internal safeguards to protect our customer's non-public information. Please visit our website to read our privacy policy: <https://goodson.com/pages/privacy-policy>.

International

Sales:

All items shipped F.O.B. Winona, MN, USA. To find a distributor near you, visit www.goodson.com.



Goodson currently has stocking distributors in:

- Austria • Australia • Belgium • Canada • Chile • Colombia • Costa Rica
- Ecuador • El Salvador • Finland • France • Germany • Guatemala
- Honduras • Ireland • Italy • Mexico • Netherlands • New Zealand
- Norway • Poland • Spain • Suriname • Sweden • Switzerland • Taiwan
- Turkey • United Kingdom • Venezuela

Resharpener & Resetting:

Goodson offers Resetting & Resharpener services for the following:

- Diamond Dressers • Brake Lathe Cutting Tips
- CBN & PCD Resurfacing Cutters • Valve Seat Cutter Blades
- Rotary Broach Tool Bits for Van Norman

Get more information and pricing by calling **1-800-533-8010**.





Coolants and Lubricants

We don't stock one type of coolant and claim that it suits all types of grinding, nor do we carry one type of oil and try to sell it for every application. Each of our many types of coolants, lubricants and oils is formulated to deliver better results and longevity in its specific use. All of our coolants prolong the life of grinding wheels, retard corrosion and rancidity. Colors may vary. **Note: Dilution ratio is water to coolant.**

All-Purpose Grinding Coolant

A synthetic water soluble coolant that "Licks Rust". Dilute 30:1

Size	Yield	Jobber	Order No.
1 gal.(3.78L)	30 gallons	\$ 31.99	CGC-1288
5 gal.(18.9L)	150 gallons	149.99	CGC-5288

Crank & Cam Grinding Coolant

Synthetic, non-nitrate, high lubricity coolant. Dilute 20:1

Size	Yield	Jobber	Order No.
1 gal.(3.78L)	20 gallons	\$ 33.99	CGC-10
5 gal.(18.9L)	100 gallons	149.99	CGC-50

Multi-Duty Grinding Coolant

Medium-duty, low foaming, synthetic coolant with rust inhibitors. Safe for ferrous and non-ferrous metals alike. No nitrates, phenols, chlorine or sulfur. Dilute 30:1

Size	Yield	Jobber	Order No.
1 gal.(3.78L)	30 gallons	\$ 37.99	GPC-10
5 gal.(18.9L)	150 gallons	179.99	GPC-50

Belt-Resurfacing Coolant

For all belt-type resurfacers with or without down-pressure. Dilute 30:1

Size	Yield	Jobber	Order No.
1 gal.(3.78L)	30 gallons	\$ 47.99	SGB-10
5 gal.(18.9L)	150 gallons	229.99	SGB-50

Resurfacing Coolant

Non-foaming, non-nitrate coolant for single-piece or resurfacing wheels. Dilute 20:1

Size	Yield	Jobber	Order No.
1 gal.(3.78L)	20 gallons	\$ 29.99	SGC-10
5 gal.(18.9L)	100 gallons	134.99	SGC-50

Flywheel Grinding Coolant

Includes a synthetic rust inhibitor that prevents rancidity. For all flywheel grinders. Dilute 30:1

Size	Yield	Jobber	Order No.
1 gal.(3.78L)	30 gallons	\$ 41.99	FG-1101-G
5 gal.(18.9L)	150 gallons	149.99	FG-1102-G

Cutting Oils

Knurlube

Lubricate while knurling.

Size	Jobber	Order No.
8 oz.(236.6mL)	\$10.49	WLB-46-G
32 oz.(946.4mL)	14.79	WLB-47-G

Cutting Aids (Aerosol)*

Helps tools cut through the hardest of metals. Clings to the surface of the tool, keeping it cool while prolonging its life.

Size	Jobber	Order No.
Cutting & Tapping Fluid	\$12.99	CTF-14*
Resurfacing Spray	12.99	HPS-16*

*Hazardous Goods Fees Apply If Shipped By Air

Valve Seat Cutting Fluid

High-silicone lube reduces drag on cutters for a better finish, longer tool life. Dilute 9:1. Water soluble.

Size	Jobber	Order No.
16 oz.(473.2mL)	\$14.99	SCF-2
1 gal.(3.78L)	31.99	SCF-10

Bronze Reaming Oil

Cuts bronze build-up while reaming. Longer tool life. Better valve guide finish.

Size	Jobber	Order No.
16 oz.(473.2mL)	\$ 9.99	BW-303-G
32 oz.(946.6mL)	15.99	BW-303A-G
1 gal.(3.78L)	35.99	BW-305-G

Lap Oil

This very fine oil prolongs the life of diamond laps. A light coat cools, lubricates and prevents wear.

Size	Jobber	Order No.
4 oz.(118.3mL)	\$10.49	LP-LO-4
8 oz.(236.6mL)	17.99	LP-LO-8

Tap Oil

Makes tapping easier & faster. Breaks down surface tension. Eliminates scuff marks & gouging. Reduces tap breakage & improves thread quality.

Size	Jobber	Order No.
7.5 oz.(221.8mL)	\$16.99	TAP-O

Grinding & Honing Oils (Not Water Soluble)

Cylinder Honing Oil (Clear)

Ideal for portable hones and all makes of automotive honing machines. Mixes readily with other brands (including Sunnen®).

Size	Jobber	Order No.
1 gal.(3.78L)	\$ 26.99	HO-10
5 gal.(18.9L)	114.99	HO-50
55 gallons	Call	HO-550

Rod Honing Oil (Dark Brown)

Keeps stones clean & free-cutting during rod reconditioning, pin fitting and other honing jobs. Will mix with other brands (including Sunnen®).

Size	Jobber	Order No.
1 gal.(3.78L)	\$ 34.99	RHO-10
5 gal.(18.9L)	174.99	RHO-50

Titanium Valve Grinding Aid

Mix ratio of 1:4. Add to valve grinding oil.

Size	Jobber	Order No.
32 oz.(946.6mL)	\$44.99	VGA-T32

Diamond Honing Oil (Brown)

Specially formulated to withstand the cutting pressures created when using our Diamond Valve Guide Honing System.

Size	Jobber	Order No.
8 oz.(236.6mL)	\$ 5.29	DHO-8
1 gal.(3.78L)	38.99	DHO-10
5 gal.(18.9L)	174.99	DHO-50

Valve Grinding Oil (Light Yellow)

Universal valve grinding oil extends wheel life. Mineral based.

Size	Jobber	Order No.
1 gal.(3.78L)	\$ 29.99	VGO-10
5 gal.(18.9L)	119.99	VGO-50

Severe Duty Valve Grinding Oil (Brown)

For grinding titanium, Inconel®, stainless steel and stellite valves.

Size	Jobber	Order No.
1 gal.(3.78L)	\$ 34.99	VGO-SD10
5 gal.(18.9L)	159.99	VGO-SD50

Machine Lubricants

Flywheel Grinder Table Lubricant

Helps extend flywheel grinder life. This high-pressure oil is designed to lubricate table bearings and ways. For all makes of flywheel grinders.

Size	Jobber	Order No.
1 gal.(3.78L)	\$39.99	FG-1131-G

Way Oil

Adhesive oil formulated to provide extended lubrication and rust protection for machine-tool ways.

Size	Jobber	Order No.
1 gal.(3.78L)	\$29.99	WO-50

Rust Shield for Shop Equipment

Prevents rust and won't cause rancidity. Protective film mixes with coolant so you don't have to clean it off before using the machine.

Size	Jobber	Order No.
1 gal.(3.78L)	\$27.99	RS-128

... another satisfied customer

"Outstanding customer service; Always. Goodson has gone above and beyond to assure we have the tooling we need here at the school."

- Jimmy Stray, School of Automotive Machinists & Technology, Houston, TX, Goodson customer since 1992

CYLINDER HEAD REBUILDING

CLEANING, ASSEMBLY & SAFETY

SHORT BLOCK REBUILDING

CRANKSHAFT/ FLYWHEEL GRINDING

MISCELLANEOUS TOOLS & SUPPLIES

BRAKE SERVICE TOOLING

MEASURING TOOLS

V-TWIN & METRIC HARD PARTS

WINONA VAN NORMAN, VAN NORMAN, PETERSON, KI (PK447S)

1-EDGE CUTTER BIT

Fits Model Numbers	Type	Bit Dia.	Jobber	Order No.
777, 900, 905, 944, 965	General	1/4"	\$40.99	VN-1
777S, 777S4, 944S, CB11, BC22XL	General	3/8"	40.99	VGS-1
	Hard Sleeves	3/8"	40.99	VGS-2
	Sleeve Cutter	3/8"	40.99	VGS-3
888, 999	General	7/16"	59.99	VN-360

Original Van Norman

Fits Model Numbers	Type	Bit Dia.	Jobber	Order No.
777S, 944S	Hard Sleeves	3/8"	\$52.99	777-179

HOLDERS FOR 6-EDGE TIPS - Use RT-6B and RT-6BT

Fits Model Numbers	Length	Height	Jobber	Order No.
777, 900, 905, 944, 965	1 7/8"	3/4"	\$162.99	VN-135
777S, 777S4, 944S	2"	1 3/16"	164.99	VN-122

Bore Range: 2.65" to 4.50"

Standard Carbide Replacement Cutter Tip	9.99	RT-6B
Titanium Coated Carbide Replacement Tip	10.99	RT-6BT

MISCELLANEOUS PARTS

Fits 6-Edge Holders Above	Description	Jobber	Order No.
	Bit Screw	\$3.99	VN-130

KWIK-WAY

1-EDGE CUTTER BIT FOR OE HOLDERS

Fits Model Numbers	Type	Bit Dia.	Jobber	Order No.
F, FT, FL, FN, FR, FS,	Rough	5/16"	\$29.99	KWL-R
FW, FWS, FWSII, FX	Finish	5/16"	29.99	KWL-F
Models After 1770	Sleeve Cutter	5/16"	29.99	KWL-C

HOLDER FOR 6-EDGE TIPS - Uses RT-6B or RT-6BT Tips

Fits Model Numbers	Length	Height	Jobber	Order No.
FL, FN, FR, FS, FT, FW	2 1/2"	5/8"	\$139.99	KWL-116

Standard Carbide Replacement Cutter Tip	9.99	RT-6B
Titanium Coated Carbide Replacement Cutter Tip	10.99	RT-6BT

PETERSON-BERCO

1-EDGE CUTTER BIT FOR OE HOLDERS

Fits Model Numbers	Length	Bit Dia.	Jobber	Order No.
ACP-151-A, ACP-151-BL, SCP-151-P	1 3/4"	10mm	\$37.99	PB-151

ROTTLER

1-EDGE CUTTER BIT FOR OE HOLDERS

Fits Model Numbers	Length	Bit Dia.	Jobber	Order No.
All Bars	1 3/4"	1 1/32"	\$22.99	RL-1
Sleeve Cutter for All Bars	1 3/4"	1 1/32"	22.99	RL-1C

HOLDER WITH 3-EDGE TIP - Includes one RL-2T Tip

Fits Model Numbers	Length	Bit Dia.	Jobber	Order No.
All Bars	1 3/4"	1 1/32"	\$28.49	RL-2H
Replacement Screw for RL-2H			3.99	RL-2S
Replacement Cutter Tip			11.99	RL-2T

STORM-VULCAN

1-EDGE CUTTER BIT FOR OE HOLDERS

Fits Model Numbers	Length	Bit Dia.	Jobber	Order No.
NS, BCG, BCT, 220, 260	3/4"	5/16"	\$41.99	S-1

SEE PAGE NP-5 FOR OUR ASSORTMENT OF SOLID CARBIDE SINGLE PASS BORING TOOLS

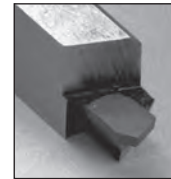

Single-Piece (Solid) Style
Holder with integral cutting bit. Excellent cutting performance. Resharpener. When no longer usable, replace entire cutter.



1-Edge Replaceable Type
Tool holder with separate bit. Excellent cutting yet economical. Resharpener the cutter bit many times. When no longer usable, replace only the bit.

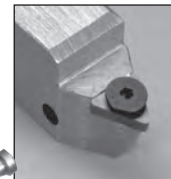

6-Edge Replaceable Type
Lowest-cost choice. Holders take 6-edge, replaceable tips. When one edge wears, turn to new surface. Never need to resharpen - just replace the tip.

The more you buy, the more you save!
Order 30 or more, save 10% off jobber

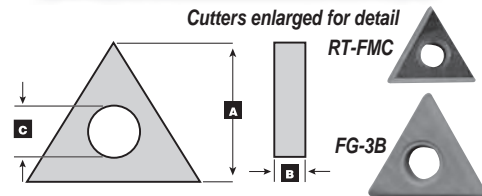

Replacement Tips & Parts

• Fit most boring bar holders

A	B	C	Edges	Jobber	Order No.
Standard Carbide					
.358"	.097"	.108"	3	\$18.99	SEQ-1
.345"	.094"	.140"	6	9.99	RT-6B
.447"	.124"	.149"	3	3.99	RT-FMC
.360"	.094"	.124"	3	10.99	FG-3B
.327"	.094"	.140"	3	11.99	RL-2T
Titanium Coated					
.345"	.094"	.140"	6	\$10.99	RT-6BT

Van Norman, Peterson or Kansas Instruments OE Catspaw Screws For 777S or PK-447S & 944S

Description	Jobber	Order No.
Catspaw Screws (1 each)		
For #1 Shoe (0.625"L)	\$9.49	800-114
For #2 Shoe (0.740"L)	10.99	800-115
For #3, 4 & 5 Shoe (0.940"L)	10.99	800-116



Mineral Based Honing Oil

- Formulated for general purpose automotive machine shop honing
- Excellent for con rods, piston pins, king pins or general shop honing
- Compatible with most popular honing machines
- 5 Gal. (18.93L)
- Order No. **MAN-845** Jobber \$152.24



Honing Oil Concentrate

- Formulated for general purpose automotive machine shop honing
- Compatible with most popular honing machines
- Add your own Mineral Oil
- Mix Ratio: 10:1 for MAN-845-5 and 2:1 to make MB-30-5
- 5 Gal. (18.93L)
- Order No. **MAN-C** Jobber \$250.61



Mineral Based Multi-Purpose Honing Oil

- High performance lubricity agents with sulfur extreme pressure additives
- Won't weld or tear the work-piece
- Works on metals from aluminum to zirconium
- 5 Gal. (18.93L)
- Order No. **MB-30** Jobber \$161.68



Water Based Honing Coolant Concentrate

- Suitable as a grinding coolant or general purpose metal working fluid for ferrous and non-ferrous parts
- 5 Gal. (18.93L) makes up to 55 gal.
- Mix Ratio: 10:1

Material	Jobber	Order No.
Hardened Steel	\$381.97	SCC-205
Cast Iron	624.99	SCC-605

Tensioner Stop Block for Chrysler 2.7 DOHC

- Eliminate broken timing chains, bent valves and chain backlash
- For VIN code R, U & V
- Mechanically supports hydraulic adjusters
- Use with plunger screw or bottom plate tensioners



Application	Jobber	Order No.
For New Chain & Tensioner	\$29.99	DT-27
For Used Chain (modifications may be required)	29.99	DT-27U

Boring Bar O-Ring Cutter Replaceable Tool Bits & Holders

- Cut grooves for O-rings to enhance gasket sealing for high-performance engines • Machines a groove .037" wide.

Description	Application	Jobber	Order No.
Tool Bits	Standard	\$72.99	KWVN-57
	Premium	79.99	KWVN-57C6

To avoid breakage, use the standard cutter on cast iron blocks only and the Premium cutter on hard blocks. **CAUTION:** Avoid column drop as this will break the tips as well.

Diamond Laps & Accessories

- A light lap oil coat cools and lubricates
- Remove build-up with lint-free cloth and Dressing Stick while lap rotates

Machine	OD	ID	Jobber	Order No.
Rottler	1 3/4"	1/4"	\$194.99	LP-RFA
Kwik-Way	3 1/4"	1/2"	269.99	LP-KW

Accessories	Jobber	Order No.
Very Fine Lap Oil (4 fl. oz.)	\$10.49	LP-LO-4
Very Fine Lap Oil (8 fl. oz.)	17.99	LP-LO-8
Dressing Stick	9.99	LP-DS

Other Diamond Laps available by Special Order



Fine Lapping Oil

- A fine, light oil
- Apply lightly to cool and lubricate

Description	Jobber	Order No.
Very Fine Lap Oil (4 fl. oz.)	\$10.49	LP-LO-4
Very Fine Lap Oil (8 fl. oz.)	17.99	LP-LO-8

1 lb. Roll Copper or Stainless Steel O-Ring Wire

- Copper: .0403" dia.
- Stainless: .0410" dia.

Description	Jobber	Order No.
Copper	\$82.99	OWC-0403
Stainless Steel	69.99	OWS-041



CYLINDER HEAD REBUILDING
CLEANING, ASSEMBLY & SAFETY
SHORT BLOCK REBUILDING
CRANKSHAFT/ FLYWHEEL GRINDING
MISCELLANEOUS TOOLS & SUPPLIES
BRAKE SERVICE TOOLING
MEASURING TOOLS
V-TWIN & METRIC HARD PARTS

tech tips

from the techperfs™

- 1 - Extend the range of your hone with the Master Holder and Stone Supports on the bottom of page 77
- 2 - Use with 1/2" non-pistol grip drill (5/8" drill for AN-815 & GH-2555)
- 3 - Heavy Duty units can also be used in manual hone cabinets

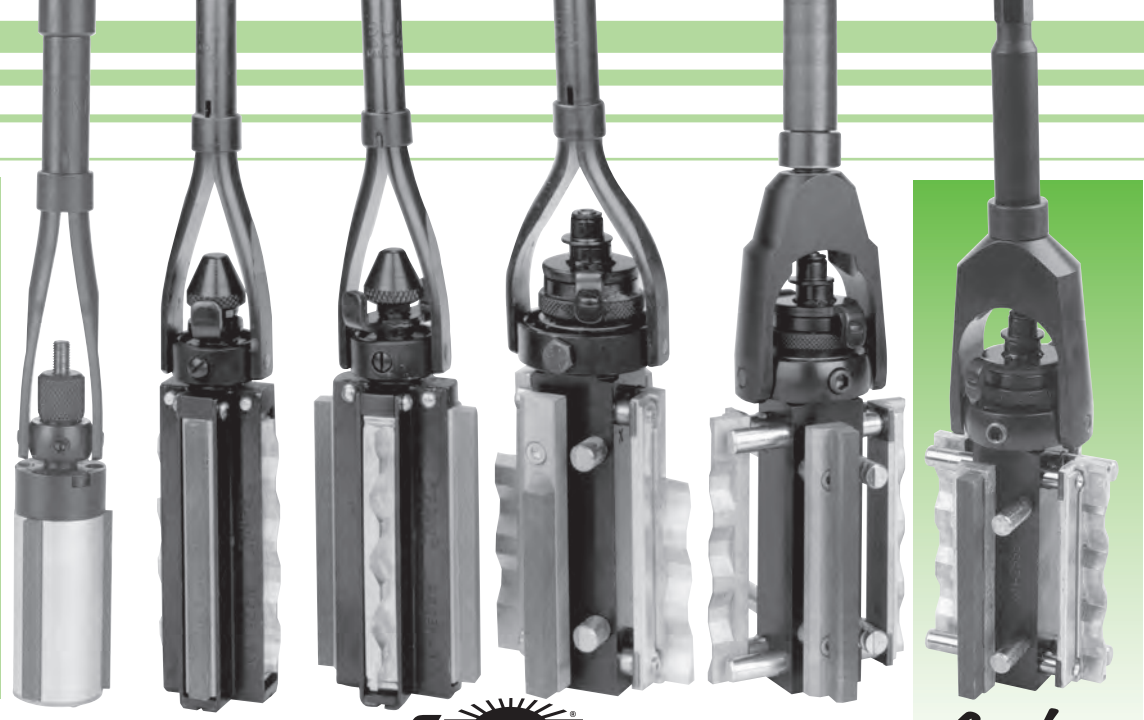

Goodson
exclusive

Portable Cylinder Hone Mandrels (stones sold separately)

Shaft extensions available.

	Junior Midget	Midget	Junior	Standard	Heavy-Duty	Heavy-Duty
Brand	Sunnen®	Sunnen®	Sunnen®	Sunnen®	Sunnen®	Goodson
Honing Range	1.25" - 1.75"	1.75" - 2.00"	2.00" - 2.60"	2.50" - 5.50"	2.50" - 5.50"	2.50" - 5.50"
Drive Shank	2.00" (incl.)	2.00" (incl.)	2.00" (incl.)	2.00" (incl.)	6.00" (incl.)	6.00" (incl.)
Drive Extension	12.00" (incl.)	12.00" (incl.)	12.00" (incl.)	12.00" (incl.)	12.00" (incl.)	12.00" (incl.)
Thread	7/16" - 14	7/16" - 14	7/16" - 14	7/16" - 14	3/8" - 11	3/8" - 11
Order No.	SNJ-10	SN-75	JN-95	AN-112	AN-815	GH-2555
Jobber	\$640.49	\$558.32	\$558.32	\$628.41	\$712.98	\$549.99

NOTE: Goodson is only authorized to ship Sunnen® products within the Western Hemisphere

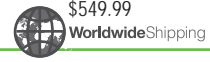

Mineral Based Honing Oil

- Formulated for general purpose automotive machine shop honing
- 5 gallons / 18.93L
- **Not** water soluble
- Order No. **MAN-845**
Jobber \$152.24

Honing Stones



• Ideal for Cast Iron

Grit	Range	mm	Finish	Sunnen	Jobber	Order No.
For Sunnen® Junior Midget Hone (SNJ-10) 3 Stones & No Wipers						
150 Grit	1.25" - 1.44"	31.8-36.6	45 Ra	-----	\$26.96	SNJ1-J45
	1.42" - 1.60"	36.1-40.6	45 Ra	-----	26.96	SNJ2-J45
	1.58" - 1.77"	40.1-44.9	45 Ra	-----	26.96	SNJ3-J45
400 Grit	1.25" - 1.44"	31.8-36.6	8 Ra	-----	26.96	SNJ1-J87
	1.42" - 1.60"	36.1-40.6	8 Ra	-----	25.23	SNJ2-J87
	1.58" - 1.77"	40.1-44.9	8 Ra	-----	22.91	SNJ3-J87
For Sunnen® Midget Hone (SN-75) 2 Stones & 2 Wipers						
70 Grit	1.75" - 2.00"	44.5-50.8	120 Ra	S18-J17	\$21.96	SN-100
150 Grit	1.75" - 2.00"	44.5-50.8	45 Ra	S18-J45	27.80	SN-200
220 Grit	1.75" - 2.00"	44.5-50.8	32 Ra	S18-J55	27.80	SN-300
280 Grit	1.75" - 2.00"	44.5-50.8	20 Ra	S18-J65	27.80	SN-500
400Grit	1.75" - 2.00"	44.5-50.8	8 Ra	-----	21.96	S18-J87
For Sunnen® Junior Hone (JN-95) 2 Stones & 2 Wipers						
70 Grit	2.00" - 2.20"	50.8-55.9	120 Ra	T20-J17	\$23.49	JN-100
	2.20" - 2.40"	55.9-60.9	120 Ra	U22-J17	23.49	JN-101
	2.40" - 2.60"	60.9-66.0	120 Ra	V24-J17	22.83	JN-102
150 Grit	2.00" - 2.20"	50.8-55.9	45 Ra	S20-J45	22.83	JN-200
	2.20" - 2.40"	55.9-60.9	45 Ra	U22-J45	23.49	JN-201
	2.40" - 2.60"	60.9-66.0	45 Ra	V24-J45	21.96	JN-202
220 Grit	2.00" - 2.20"	50.8-55.9	32 Ra	T20-J65	23.49	JN-300
	2.20" - 2.40"	55.9-60.9	32 Ra	U22-J55	23.49	JN-301
	2.40" - 2.60"	60.9-66.0	20 Ra	V24-J65	23.49	JN-501
280 Grit	2.00" - 2.20"	50.8-55.9	20 Ra	T20-J65	21.96	JN-500
	2.20" - 2.40"	55.9-60.9	20 Ra	U22-J65	23.49	JN-501
	2.40" - 2.60"	60.9-66.0	20 Ra	V24-J65	23.49	JN-502
400 Grit	2.00" - 2.20"	50.8-55.9	8 Ra	-----	20.12	T20-J87
	2.20" - 2.40"	55.9-60.9	8 Ra	-----	20.12	U22-J87
	2.40" - 2.60"	60.9-66.0	8 Ra	-----	22.83	V24-J87

Clear Mineral Based Honing Oil

- Helps keep stones clean and free-cutting
- Ideal for portable hones and all makes of automotive honing machines
- Mixes easily with other brands, including Sunnen®
- **Not** water soluble



Size	Jobber	Order No.
1 Gal./3.78L	\$ 26.99	HO-10
5 Gal./18.9L	114.99	HO-50



American Made

Goodson and Sunnen® Cylinder Honing Stones For all popular AN-style Hones and Hone Bodies

- Integral holder type Honing stone sets have 4 pieces: 2 holders with stones and 2 holders with aluminum wipers
- Fit Sunnen® AN Standard, AN Heavy-Duty and Goodson **GH-2555** hones
- Use with honing oil
- Stones for Short or Blind Holes are 2¹³/₁₆" long; All other stones are 4" long

Grit	Bore Range		Usage	Finish	SUNNEN®			GOODSON		
	in	mm			Jobber	Order No.	Sunnen No.	Jobber	Order No.	
70 Grit Roughing	2.5"-2.7"	63.5-68.6	Cast Iron	120 Ra	\$29.86	AN-115	G25-J17	\$26.99	HN-115S	
	2.7"-4.1"	68.6-104.1	Cast Iron	120 Ra	29.86	AN-100	M27-J17	26.99	HN-100S	
			Cast Iron	120 Ra	—	—	—	26.99	HN-100R¹	
			Short/Blind	120 Ra	30.89	AN-100-71	M27-J17-71	26.99	HN-102S	
			Harley / VW	120 Ra	37.40	AN-100F	M27-J17	26.99	HN-100F	
	3.5"-5.5"	88.9-139.7	Cast Iron	120 Ra	29.86	AN-101	N37-J17	26.99	HN-101S	
			Cast Iron	120 Ra	—	—	—	26.99	HN-101R¹	
			Short/Blind	120 Ra	30.89	AN-101-71	N37-J17-71	26.99	HN-104S	
			Hard Sleeves	55 Ra	29.86	AN-131	N37-J11	26.99	HN-131S	
	Use Master Holder & Sleeve Support	4.7"-15.0"	119.4-381	Cast Iron	120 Ra	29.86	AN-106	W47-J17	26.99	HN-106S
Hard Sleeves				55 Ra	29.86	AN-136	W47-J11	26.99	HN-136S	
150 Grit Medium	2.5"-2.7"	63.5-68.6	Cast Iron	45 Ra	29.86	AN-215	G25-J45	26.99	HN-215S	
	2.7"-4.1"	68.6-104.1	Cast Iron	45 Ra	29.86	AN-200	M27-J45	26.99	HN-200S	
			Short/Blind	45 Ra	27.46	AN-200-71	M27-J45-71	26.99	HN-202S	
			Hard Sleeves	30 Ra	—	—	—	26.99	HN-230S	
	3.5"-5.5"	88.9-139.7	Cast Iron	45 Ra	29.86	AN-201	N37-J45	26.99	HN-201S	
			Short/Blind	45 Ra	30.89	AN-201-71	N37-J45-71	26.99	HN-204S	
			Hard Sleeves	30 Ra	29.86	AN-231	N37-J43	26.99	HN-231S	
	Use Master Holder & Sleeve Support	4.7"-15.0"	119.4-381.0	Cast Iron	45 Ra	29.86	AN-206	W47-J45	26.99	HN-206S
				Hard Sleeves	30 Ra	29.86	AN-236	W47-J43	26.99	HN-236S
	220 Grit Finishing	2.7"-4.1"	68.6-104.1	Cast Iron	32 Ra	29.86	AN-300	M27-J55	26.99	HN-300S
Short/Blind				32 Ra	30.89	AN-300-71	M27-J55-71	26.99	HN-302S	
3.5"-5.5"		88.9-139.7	Cast Iron	32 Ra	29.86	AN-301	N37-J55	26.99	HN-301S	
			Short/Blind	32 Ra	30.89	AN-301-71	N37-J55-71	26.99	HN-304S	
			Cast Iron	32 Ra	29.86	AN-306	W47-J55	26.99	HN-306S	
Use Master Holder & Sleeve Support	4.7"-15.0"	119.4-381	Cast Iron	32 Ra	29.86	AN-306	W47-J55	26.99	HN-306S	
280 Grit Fine Finish	2.5"-2.7"	63.5-68.6	Cast Iron	20 Ra	29.86	AN-515	G25-J65	26.99	HN-515S	
	2.7"-4.1"	68.6-104.1	Cast Iron	20 Ra	29.86	AN-500	M27-J65	26.99	HN-500S	
			Short/Blind	20 Ra	30.89	AN-500-71	M27-J65-71	26.99	HN-502S	
			Hard Sleeves	12 Ra	29.86	AN-530	M27-J63	26.99	HN-530S	
	3.5"-5.5"	88.9-139.7	Cast Iron	20 Ra	29.86	AN-501	N37-J65	26.99	HN-501S	
			Short/Blind	20 Ra	30.89	AN-501-71	N37-J65-71	26.99	HN-504S	
			Hard Sleeves	12 Ra	—	—	—	26.99	HN-531S	
	Use Master Holder & Sleeve Support	4.7"-15.0"	119.4-381.0	Hard Sleeves	12 Ra	29.86	AN-536	W47-J63	26.99	HN-536S
				Cast Iron	20 Ra	29.86	AN-506	W47-J65	26.99	HN-506S
	400 Grit Extra Fine Finish	2.5"-2.7"	63.5-68.6	Cast Iron	8 Ra	29.86	G25-J87	G25-J87	26.99	HN-615S
2.7"-4.1"		68.6-104.1	Cast Iron	8 Ra	28.99	M27-J87	M27-J87	26.99	HN-600S	
			Hard Sleeves	5 Ra	28.99	M27-J85	M27-J85	26.99	HN-630S	
3.5"-5.5"		88.9-139.7	Cast Iron	8 Ra	29.86	N37-J87	N37-J87	26.99	HN-601S	
			Hard Sleeves	5 Ra	29.86	N37-J85	N37-J85	26.99	HN-631S	
Cork Polishing	2.5"-3.3"	63.5-83.8	Cast Iron*	2-3 Ra	39.45	G25-C05	G25-C05	—	—	
	3.3"-4.2"	83.8-106.7	Cast Iron*	2-3 Ra	59.12	MM33-C05	MM33-C05	—	—	
	4.0"-5.6"	101.6-142.2	Cast Iron*	2-3 Ra	59.12	NN40-C05	NN40-C05	—	—	

(*Cast Iron – 3 Ra., Hard Sleeves – 2 Ra., Steel– 3 Ra.)

¹Ruby Aluminum-Oxide abrasive for longer life in rough cutting use



Master Holder & Stone Supports

- Holds one 4" stone set
- Stones sold separately
- AN-365 requires use of AN-260
- Larger sizes available upon special order

Master Holder			
Dia. Range	Jobber	Order No.	
4.7"-7.0"	\$158.31	AN-355	
6.0"-9.0"	153.48	AN-365	
Stone Supports for AN-365			
6.0"-9.0"	\$105.74	AN-260	

Note: Larger sizes available by special order.

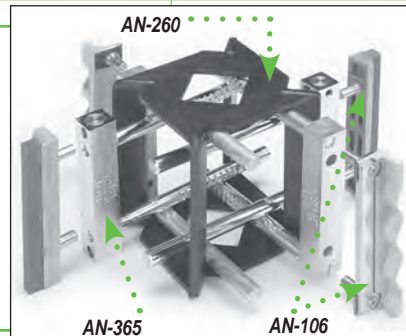

CYLINDER HEAD REBUILDING
CLEANING, ASSEMBLY & SAFETY
SHORT BLOCK REBUILDING
CRANKSHAFT/ FLYWHEEL GRINDING
MISCELLANEOUS TOOLS & SUPPLIES
BRAKE SERVICE TOOLING
MEASURING TOOLS
V-TWIN & METRIC HARD PARTS



"Turn to the Goodson website to find information and place orders from anywhere at any time. And be sure to follow us on Facebook and Twitter."
Crystal, Goodson Advertising, 5 years of service

CYLINDER HEAD REBUILDING
CLEANING, ASSEMBLY & SAFETY
SHORT BLOCK REBUILDING
CRANKSHAFT/ FLYWHEEL GRINDING
MISCELLANEOUS TOOLS & SUPPLIES
BRAKE SERVICE TOOLING
MEASURING TOOLS
V-TWIN & METRIC HARD PARTS

Keyway Honing Stone Sets

- Two-stroke engines have intake and exhaust ports that interrupt the operation of your honing stone
- These stones allow the hone to pass the intake and exhaust ports while maintaining consistent pressure to remove material accurately and easily
- Use with any AN- or GH-series hone (p. 76)
- For Cast Iron

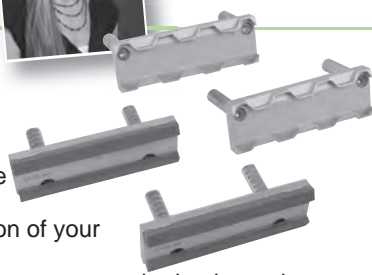

Grit	Range	mm	Finish	Type	Jobber	Order No.
150 Grit	2.5" - 3.3"	63.5 - 83.8	45 Ra	Alum.	\$45.55	GY25-J45
Medium	3.3" - 4.2"	83.8 - 106.7	45 Ra	Alum.	44.26	MY33-J45
280 Grit	2.5" - 3.3"	63.5 - 83.8	20 Ra	Brass	45.55	GY25-J65
Fine Finish	3.3" - 4.2"	83.8 - 106.7	20 Ra	Soft	45.55	MY33-J65
400 Grit	2.5" - 3.3"	63.5 - 83.8	8 Ra	Brass	45.55	GY25-J85
Extra Fine	3.3" - 4.2"	83.8 - 106.7	8 Ra	Soft	44.26	MY33-J85

EHU GEHN type stones

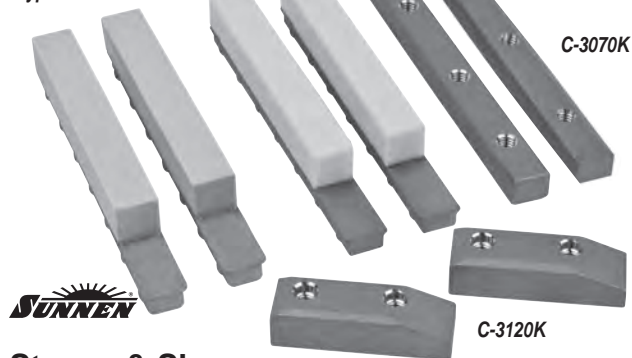

Stones & Shoes for Sunnen Hone Machines

- Premium-quality replacements for all CV-616, and CK-10 hones equipped with Sunnen® Master Holder Sets
- Diameter Range: 4.125" - 5.000" (104.8 - 127.0mm)
- Use with Master Holder Set CK-3045A (sold separately)
- 2 stones per set

Stones			Goodson - 1 set		Sunnen - 6 sets	
Use	Grit	Finish	Jobber	Order No.	Jobber	Order No.
Hard Blocks	70	60 Ra	\$13.99	GEHN-116	\$85.45	EHN-116
Hard Blocks	220	22-32 Ra	13.99	GEHN-512	89.04	EHN-512
Air Cooled Cyl.	220	22-32 Ra	13.99	GEHN-518	83.17	EHN-518
Hard Blocks	70	60 Ra	13.99	GEHU-123	89.04	EHU-123
Roughing	70	60 Ra	13.99	GEHU-133	86.45	EHU-133
Hard Blocks	220	22-32 Ra	13.99	GEHU-518	89.04	EHU-518
Gen. Purp.	220	22-32 Ra	13.99	GEHU-525	89.04	EHU-525
Aluminum	220	30-36 Ra	13.99	GJHU-525	89.04	JHU-525
High Nickel	280	20-25 Ra	13.99	GJHU-623	89.04	JHU-623
Finishing	280	16-23 Ra	13.99	GJHU-625	89.04	JHU-625
High Nickel	400	7-14 Ra	13.99	GJHU-818	89.04	JHU-818
Aluminum	400	7-14 Ra	13.99	GJHU-820	86.45	JHU-820
Accessories			Qty.	Jobber	Order No.	
Sunnen® Master Holder Set			1	\$257.40	CK-3045A	
Sunnen® Centering Guide (includes CK-3070)			1	129.31	CK-3090A	
Sunnen® Guide Shoe & Screw Set			1	20.97	CK-3070	
Sunnen® Guide Shoe & Screw Set			1	30.21	CK-3120	
Goodson Wear Shoe			2	33.99	C-3070K	
Goodson Stabilizing Shoe			2	37.99	C-3120K	

For Rod Honing Stones and Shoes see page 83



Tooling for Honing Dart Blocks & Ductile Sleeves

- Recommended for Dart™ Machinery
- Use with Sulfurated Rod Honing Oil (RHO-10 or RHO-50, p. 73) for all stone applications below

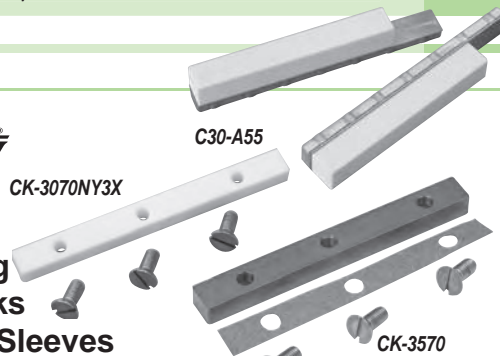

Description	Jobber	Order No.
Honing Stone Sets For Portable Tooling		
80 Grit	\$24.04	N37-A25
220 Grit	24.04	N37-A55
280 Grit	29.86	AN-501
400 Grit	36.20	MM33-J85
For CK/CV Type Machines		
80 Grit Stone Set (6)	\$ 88.91	C30-A25
150 Grit Stone Set (6)	89.05	C30-A45
220 Grit Stone Set (6)	89.05	C30-A55
280 Grit Stone Set (6)	91.05	C30-J65
400 Grit Stone Set (6)	88.88	C30-J85
Hardened Steel Guide Shoe (1)	164.36	CK-3570
Delron® Guide Shoe (1)	112.08	CK-3070NY3X
Goodson Brand Shoes For CK/CV Type Machines		
Hardened Steel Guide Shoe (1)	\$124.99	GCK-3570
Delron® Guide Shoe (1)	94.99	GCK-3070NY3X

tech tips For CK & CV Machines, **DO NOT** use Bronze Guide Shoes, use from the techxperts™ Hardened Steel and Delron shoes above (1 of each)

tech tips

Achieving a plateaued cylinder is a multi-step process. One that is far too detailed for the small space available here. Read more about this process on the Goodson Blog. Search for **Plateau Honing 101**.



Ultra-Finish Plateau Hones

- For Portable Hones, Hone Cabinets and CV/CK Tooling
- Abrasive impregnated nylon bristles
- Ideal for high-performance rebuilding and rebuilding newer style engines that use low-tension rings
- Superior plateau finish so rings will seal immediately
- Reduces break-in time
- Allows closer tolerances for improved compression, better oil control, lower emissions • Fits AN- or GH-series hones

For Portable Hones and Hone Cabinets – Includes 1 pair			
AN/ GH-Style	3.78" - 4.68"	96.0 - 118.9	\$294.65 MM-PHT-731
For Sunnen CV / CK Hone Heads – Includes 1 pair			
Standard	3.10" - 5.00"	78.7 - 127.0	\$201.59 C30-PHT-731

Note: Others available by special order.



Original Ammco Honing Stone Sets

- For Ammco 500 Hones
- Includes 2 stones and 2 felt wipers
- Use dry for best performance • ½"W x 4"L

Grit	Qty	OE #	Jobber	Order No.
60	4	#619	\$84.99	AHS-70
220	4	#620	84.99	AHS-220
400	4	#621	84.99	AHS-400

Lisle® Honing Stone Sets

- Clip-on style mounts in seconds
- 5"/127mm long stones and wipers
- Each set contains two stones and two felt wipers
- Use dry

Replaces Lisle® No.	Grit	Order No.
15500	80	HL-80
15510	180	HL-180
15520	280	HL-280
15590	500	HL-500

Jobber per set \$16.99

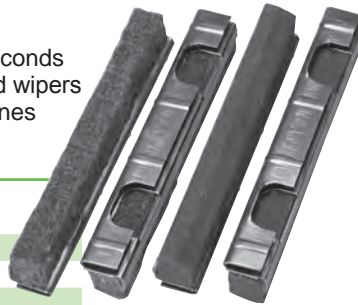

tech tips Why so many honing oils?

The HO series of honing oil was designed by the Goodson tech staff, to be clear and is formulated to offer the machinist a more aggressive result when honing various cast iron and steel alloys. Some say it has a drier effect that allows faster stock removal while keeping the honing stones, clean and more free cutting.

We went with a clear oil instead of a dark because you can easily monitor the swarf content of the oil. Since you can see what kind of gunk you're accumulating, you can change filters and filter paper as needed to lengthen the over-all life of the oil in the honing tank. We recommend Goodson HO oil for Vitrified Stones only.

Goodson HO oil is true oil and it can be mixed with other brands of honing oils, such as the Sunnen MAN-845 and others. This oil is not designed to be mixed or used with any water-based honing solutions.

The RHO series honing oil was developed for high pressure honing such as connecting rod honing. This oil also contains additional lubricants to enhance honing these smaller diameters that are on the big end of the connecting rod generally made from iron and steel, but may also have a brass or bronze bushing that also needs to be honed to size. Goodson RHO oil is just what you need as it contains additives to make this possible.

Like Goodson HO oil, RHO is compatible with most other connecting rod honing oils but, again, never mix this oil with any water-based honing solution.

The newest addition to our selection of honing oils is the DHO series. This honing oil was designed for higher pressure that occurs when honing small diameters in materials such as Bronze, Manganese Bronze and other combinations of bronze materials using diamond abrasives such as the Goodson Hyper-Finish System and the Sunnen Diamond Sizing Tool.

Goodson incorporated an additional lubrication into the formula to allow the oil to act slicker when honing the smaller diameters in these softer bronze valve guide materials. This oil can be mixed with our RHO series of honing oil or with Sunnen MAN-845 types of honing oil. As with the other Goodson honing oils, Do Not mix with water.

Order 5 or more cones (any combination), SAVE 10% off jobber



82° 3" Dia. Chamfering Cones & Mandrel

- Chamfer sharp edges for safe piston and ring installation
- Handles all diameter cylinders or sleeves
- Fits ⅜"/9.53mm or larger drill • Kit (CC-100) includes mandrel and three 50 Grit Aluminum Oxide cones (CC-15)
- Due to manufacturing process, abrasive color may vary

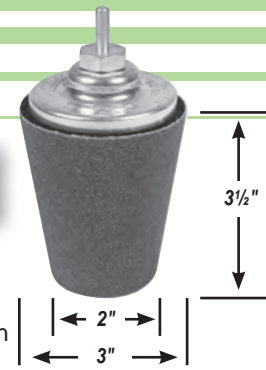

Description	Jobber	Order No.	Incl.
3" Top Dia. Chamfering Cone Kit	\$55.79	CC-100	▼
Replacement ⅜" Drill Adaptor	14.99	CC-100-1	x
Aluminum Oxide Chamfering Cones (red)			
40 Grit	\$ 8.99	CC-14	
50 Grit	8.99	CC-15	x
80 Grit	8.99	CC-20	
Premium Zirconia Chamfering Cones (blue)			
50 Grit	\$ 9.99	CCZ-15	
80 Grit	9.99	CCZ-20	

Order 5 or more cones (any combination), SAVE 10% off jobber



45° 5"/127mm dia. Chamfering Cones & Mandrel

- Large diameter cones chamfer the top of the cylinder to an exact 45° angle in one pass
- ½"/12.7mm steel shank permanently embedded in the base
- Cone height: 3½"/88.9mm
- Kit includes mandrel & one 36-grit cone (CC-30)
- Due to manufacturing process, abrasive color may vary

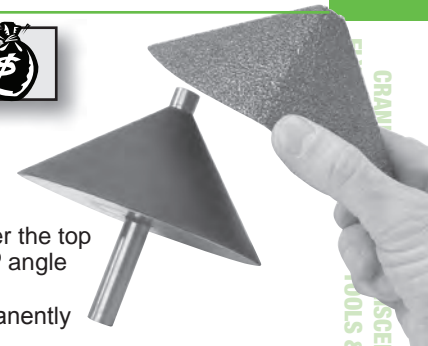

Description	Jobber	Order No.	Incl.
5" Chamfering Cone Kit	\$121.99	CC-130	▼
Chamfering Cones			
Abrasive	Grit		
Aluminum Oxide (red)	36	\$ 8.99	CC-30
	50	8.99	CC-50
	80	8.99	CC-80
Premium Zirconia (blue)	36	10.99	CCZ-36
	50	10.99	CCZ-50
	80	10.99	CCZ-80

Clear Honing Oil

- Helps keep stones clean and free-cutting
- Ideal for portable hones and all makes of automotive honing machines
- Mixes easily with other brands, including Sunnen®
- Not water soluble

Size	Jobber	Order No.
1 gal./3.78L	\$ 26.99	HO-10
5 gal./18.9L	114.99	HO-50



CYLINDER HEAD REBUILDING
CLEANING, ASSEMBLY & SAFETY
SHORT BLOCK REBUILDING
CRANK REBUILDING
SCCELLANEOUS TOOLS & SUPPLIES
BRAKE SERVICE TOOLING
MEASURING TOOLS
V-TWIN & METRIC HARD PARTS

... another
satisfied
customer

"Your company should hold a seminar on how to run a company. I received your products the day following my order. When ordering from other companies they tell me it'll be 2-4 weeks because they are busy. It's nice to have great service these days. Thank you and keep up the great work!"

- Ray Temple, Waupaca, Wisconsin, Goodson customer since 2009

CYLINDER HEAD
REBUILDING

CLEANING,
ASSEMBLY & SAFETY

SHORT BLOCK
REBUILDING

CRANKSHAFT/
FLYWHEEL GRINDING

MISCELLANEOUS
TOOLS & SUPPLIES

BRAKE SERVICE
TOOLING

MEASURING
TOOLS

V-TWIN & METRIC
HARD PARTS



Honing Stones for Nicasil

- Deglaze Nicasil cylinders with portable hones
- 150 Grit Aluminum-Oxide abrasive
- Resizing cylinders requires diamond abrasive
- For AN-style and GH-style hones

Inches	Metric	Jobber	Order No.
2.500" - 3.300"	(64 - 84mm)	\$35.13	GG25-A43
3.300" - 4.200"	(84 - 107mm)	35.13	MM33-A43
4.000" - 5.600"	(102 - 142mm)	33.81	NN40-A43

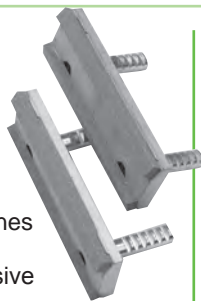

Honing Stone Sets For Nicasil

- For deglazing Nicasil with a CV/CK Honing Machine
- Diameter Range:
 - 3.0" - 5.0" (76.2-127.0mm) in standard automotive head
 - 2.6" - 3.5" (66.0-88.9mm) in junior head
- 150 grit aluminum oxide abrasive
- 2 stones per set; 6 sets per package
- Order No. **EHU-412** Jobber \$89.04



1" Thick Rod Hone Filter Mat

- Synthetic material
- Traps abrasive particles & metal filings BEFORE they enter the storage tank
- Cushions parts to prevent damage
- Replace when clogged
- 1" (25.4mm) thick

Inches	Metric	Jobber	Order No.
18" x 25"	45.7 x 63.5 cm	\$15.99	RH-MAT
26" x 40"	66.0 x 101.6 cm	24.99	RH-MAT-2
33" x 48"	83.8 x 121.9 cm	24.99	RH-MAT-3

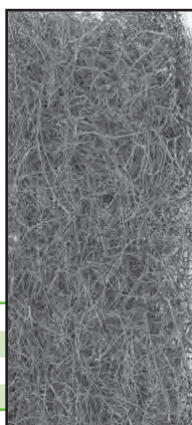

Hone Cabinet Filter Paper

- Reduce sump and filter clean-up
- Extend oil life
- Filter paper in the bottom of hone machine removes debris before oil enters the sump
- When full, dispose of properly
- 2 - 60" x 60" sheets (trim to fit)
- Order No. **HN-FP** Jobber \$19.99

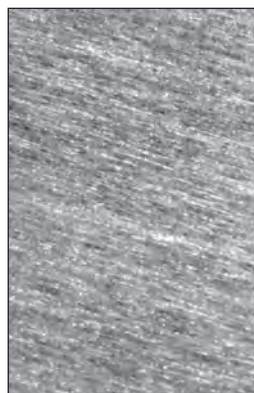

tech tips Tips for Honing Nicasil

from the techxperts™

Nicasil is an electro-deposited (electroplated) composite of nickel and silicon carbide. Components are uniformly dispersed throughout the resulting material. Care must be used when honing this material as the plating is normally applied in thicknesses no greater than .003". If you remove too much of the Nicasil, you will need to have the cylinder bores re-plated. The wear ratio on Nicasil is 10:1 so .010" wear in a normal cylinder would be only .001" on Nicasil.

An aluminum-oxide abrasive is necessary for honing Nicasil as silicon-carbide is a part of the material and abrasives will not cut materials of similar density and composition.

We recommend using our Rod Honing Oil when working on Nicasil. The additives that make it ideal for high pressure honing also help the aluminum oxide abrasive cut cleaner and faster on a Nicasil surface.

If you have any other questions about honing Nicasil, be sure to call one of the Techxperts™ at Goodson 1-800-533-8010.



Rod Honing Oil

- Includes additives for high pressure cutting
- Keeps stones clean and free-cutting during rod reconditioning, pin fitting and other honing applications
- Will mix with other honing oils (including Sunnen®)

Size	Jobber	Order No.
1 gal./3.78L	\$ 34.99	RHO-10
5 gal./18.9L	174.99	RHO-50

Order 3 or more Flex-Hones® (mix & match) and save 10% off jobber



Use with RHO-10

Standard Duty 240 Grit Aluminum Oxide Flex-Hones® For Nicasil

Inch	mm	Jobber	Order No.	Inch	mm	Jobber	Order No.
2¼"	57.2	\$29.99	BA-225240	3¼"	82.5	\$57.99	BA-325240
2½"	60.2	38.99	BA-237240	3½"	88.9	61.99	BA-350240
2½"	63.5	37.99	BA-250240	3¾"	95.3	64.99	BA-375240
2¾"	66.5	39.99	BA-262240	4¼"	104.8	69.99	BA-418240
2¾"	69.8	39.99	BA-275240	4½"	117.5	79.99	BA-462240
3"	76.2	49.99	BA-300240				More Flex-Hones® on page 72

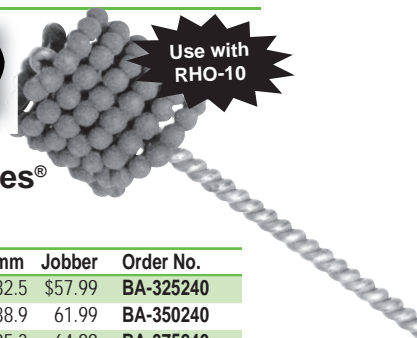

Cylinder Boring & Honing

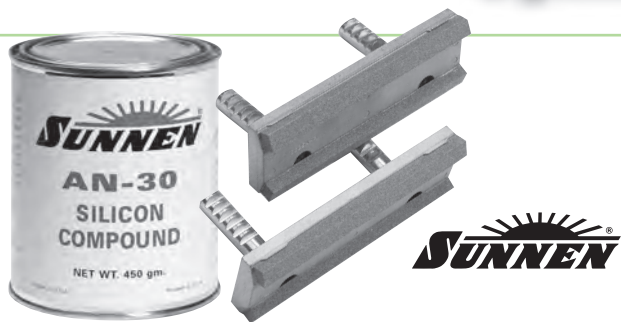

Hone High-Silicon Aluminum Alloy Blocks With Ease – Honing Stones & Silicon Compound

- Stones fit both the Sunnen® AN-112 and AN-815 and the Goodson GH-2555 Portable Honing Mandrels
- Use each stone set progressively until the final bore size is achieved • For Hone Diameter: 3.3" to 4.2"
- To create the final condition, coat the felt set and the honed cylinder surface with the Silicon Compound (AN-30) and lap the cylinders
- After completion, the cylinder will have a dull matte finish
- Piston and rings will ride on silicon instead of aluminum
- Silicon Compound 1 lb. / 450g

Description	Jobber	Order No.
Roughing (280 grit)	\$35.13	MM33-J63
Finishing (400 grit)	36.20	MM33-J85
Polishing (600 grit)	59.12	MM33-C05
Felt Set	61.70	MM33-F05
Silicon Compound	60.49	AN-30



Mandrel Driver for Align Honing Machines

- For Sunnen® CH-100 & similar align honing machines
- Graduated adjustment knob advances and retracts honing stones
- Quick release lever allows hone removal and installation without resetting
- Stone pressure adjusts with dial
- Automatically advances stones during honing
- **NOT** for portable honing applications
- Order No. **CH-75A** Jobber \$1069.50



Main Bore Align Hone Mandrels

- For the Sunnen® CH-100 Aline Honing Machine
- Hone unit includes 1 set of 10 stones and 1 set of 20 shoes (replacement stones & shoes available)

Range	Mandrels				Shoes (10/box)	
	mm	Jobber	Order No.	Jobber	Order No.	
2.4"-2.7"	61-69	\$3329.36	10RY-2400G	\$81.51	RG-D	
2.7"-3.0"	69-77	3438.13	10RY-2700G	81.51	RG-D	
3.0"-3.5"	77-89	3812.75	10RY-3000H	85.16	RH-D	
Stones 5/box		89.97	RY24-J49 (recommended for cast iron)			
fit all mandrels above		92.71	RY24-J45 (recommended for aluminum)			

More stones and shoes are available by special order, call to inquire.

1-800-533-8010

Right Hand Rotation Only.

tech tips

For best results, keep your RPM about the same as your hone RPM, use the same rate of speed from the techxperts™ and number of strokes per minute.

Ultra-Finish Plateau Soft Hones

- Remove microscopic peaks and scuffs without enlarging bores • Use with a portable drill • Abrasive impregnated nylon bristles • Ideal for high-performance engine rebuilding and for engines that use low-tension rings
- Use after honing
- Gives a superior plateau finish so rings seal immediately, reducing break-in time
- Allows closer tolerances for improved compression, better oil control, lower emissions
- For best results, use liberal amounts of honing oil (**HO-50**, pg. 73) • **NOT** interchangeable with Flex-Hones®

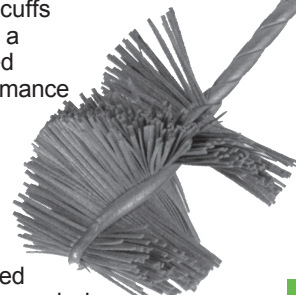

Hole Diameter Range in	Hone mm	Head Dia.	Head Length	Overall Length	Jobber	Order No.
.875"-1.00"	22-25	1.250"	2.00"	10.00"	\$44.99	UF-100
1.00"-1.25"	25-32	1.500"	2.00"	10.00"	49.49	UF-125
1.25"-1.75"	32-45	2.000"	2.00"	10.00"	49.49	UF-175
1.75"-2.25"	45-57	2.500"	2.00"	10.00"	49.49	UF-200
2.25"-2.75"	57-70	3.000"	3.00"	10.00"	49.99	UF-250
2.50"-3.00"	63-76	3.500"	4.00"	14.00"	49.99	UF-300
3.00"-3.50"	76-89	4.000"	4.00"	14.00"	61.79	UF-350
3.50"-4.00"	89-102	4.500"	4.00"	14.00"	61.79	UF-400
4.00"-4.50"	102-114	5.000"	5.00"	14.00"	61.79	UF-450
4.50"-5.00"	114-127	5.500"	5.00"	14.00"	61.79	UF-500

Valve Guide Plateau Hones on page 33



Replacement PF Filter Cartridges

- Cartridges remove grit, metal and dirt from honing oil
- Fit Sunnen® CK-10, CV-616, LBB-1810, PF-150 and CH-100 honing machines



Description	Application	Qty.	Jobber	Order No.
Extra Fine	Oil Only	4 Pk.	\$176.36	PF-105-4
Fine	Oil Only	4 Pk.	181.87	PF-110-4
Extra Fine	Water Only	1 Pk.	130.19	PF-104
Fine (Fiberglass)	Water Only	1 Pk.	125.38	PF-160

Machine Capacities

Mfr.	Machine	Capacity
Sunnen	LBB-1699	15 Gal.
	LBB-1660	15 Gal.
	LBB-1810	25 Gal.
	LBB-1803	25 Gal.
	EC-3500	32 Gal.
	ML-3500	32 Gal.
	ML-5000	32 Gal.
	ML-2000	28 Gal.
	CK-10	55 Gal.
	CV-616	55 Gal.
	SV-10	55 Gal.
CK-21	63.5 Gal.	

Machine Capacities

Mfr.	Machine	Capacity
Rottler	H85AXY	70 Gal.
	H85A	70 Gal.
	H85AX	70 Gal.
	H86A	70 Gal.
	H86AX	70 Gal.
	H86AXY	70 Gal.

tech tips
from the techxperts™

CYLINDER HEAD REBUILDING
CLEANING, ASSEMBLY & SAFETY
SHORT BLOCK REBUILDING
CRANKSHAFT/ FLYWHEEL GRINDING
MISCELLANEOUS TOOLS & SUPPLIES
BRAKE SERVICE TOOLING
MEASURING TOOLS
V-TWIN & METRIC HARD PARTS

... another satisfied customer

"I bought your regular honing oil, and it does a fine job and it cuts well, however, when I found out the RHO honing oil might be a better deal, I began taking gallons of RHO honing oil and adding it to my tank to make it hone better, and sure enough I found that by adding the RHO honing oil, the stones cut faster without clogging."

- George Livergood, Action Machine Shop, Goodson customer since 2010

CYLINDER HEAD REBUILDING
CLEANING, ASSEMBLY & SAFETY
SHORT BLOCK REBUILDING
CRANKSHAFT/ FLYWHEEL GRINDING
MISCELLANEOUS TOOLS & SUPPLIES
BRAKE SERVICE TOOLING
MEASURING TOOLS
V-TWIN & METRIC HARD PARTS



Stones Guide Shoe

CR-Series Mandrels Stones & Replacement Parts

Honing Stones for Manual Honing*

Fit Mandrels	Finish	Jobber	Sunnen Order No.	Jobber	Goodson Order No.
CR-1450 to 1750	Medium	\$23.90	CR-2	-----	-----
	Fine	23.90	CR-4	-----	-----
CR-1900 & Larger	Aluminum/ Titanium	23.27	CR-9	-----	-----
	Roughing	23.27	CR-10	12.99	HC-10
	Medium	23.90	CR-12	13.99	HC-12
	Fine	23.90	CR-14	13.99	HC-14
For Power Hone	Roughing	25.76	CR-10N	-----	-----
Guide Shoes (2 per box)					
CR-1450 to 1750	Die Cast	\$ 9.46	CR-40D	-----	-----
CR-1900 & larger	Die Cast	9.99	CR-50D	-----	-----
	Bronze	44.72	CR-50B	-----	-----

Wedge & Wedge Plates

CR-1450 to 1750	Wedge	\$78.85	CR-70	-----	-----
	Small Plate	32.98	CR-75	-----	-----
	Large Plate	32.14	CR-85	-----	-----
CR-1900 to 2500	Wedge	44.22	CR-100	-----	-----
CR-1900 & Larger	Small Plate	38.06	CR-110	-----	-----
	Large Plate	38.06	CR-120	-----	-----
CR-2900	Wedge	54.75	CR-200	-----	-----
Sunnen® Tension Block For CR-2900 & Larger		\$12.87	LN-1337A	-----	-----
Sunnen® Shoe Clamps (4 + screws) for CR-1900 & larger		94.25	CR-45A	-----	-----

*Sunnen® honing stones include 2/box, Goodson include 1/box

Mandrel Driver for Portable Use of CR-, PL- and ML-Series Hones

- Ideal for spindle bushings mounted on axles and other jobs that can't be taken to the honing machine
- For holes 3/4"/19.05mm ID and larger, where length is at least 3 times the diameter
- ID Range: .744" - 3.875"/19mm - 98mm
- Graduated adjustment knob advances and retracts stones • 275 - 450 RPM range
- Use with any 1/2"/12.7mm drill or larger
- Order No. **GGN-150** Jobber \$894.28



Rod Honing Oil

- Includes additives for high pressure cutting
- Keeps stones clean and free-cutting during rod reconditioning, pin fitting and other honing applications
- Will mix with other honing oils (including Sunnen®)



Size	Jobber	Order No.
1 gal./3.78L	\$ 34.99	RHO-10
5 gal./18.9L	174.99	RHO-50

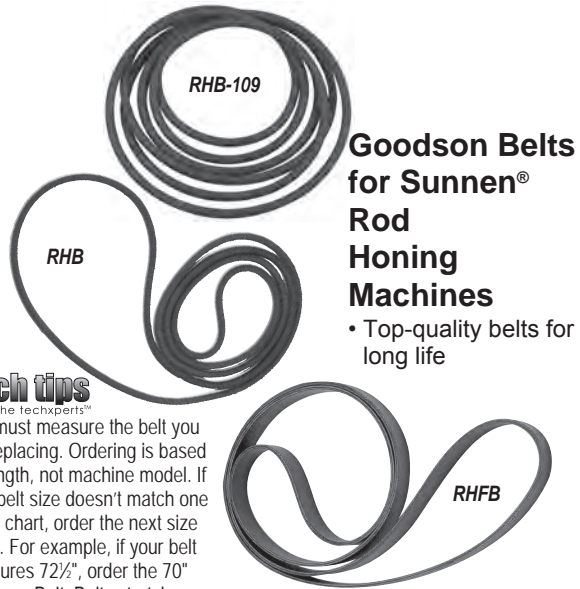

Goodson Belts for Sunnen® Rod Honing Machines

- Top-quality belts for long life

tech tips

from the techxperts™
You must measure the belt you are replacing. Ordering is based on length, not machine model. If your belt size doesn't match one in the chart, order the next size down. For example, if your belt measures 72 1/2", order the 70" Oil Pump Belt. Belts stretch over time so the shorter belt will fit.

Size	Jobber	Order No.
Oil Pump Belts (.250" dia.)		
70"/1.78m	\$ 97.99	RHB-70
74"/1.88m	97.99	RHB-74
85"/2.16m	97.99	RHB-85
109"/2.77m	113.99	RHB-109
Flat Belts		
45 1/2" x 3/8"/1155.7x15.9mm	118.99	RHFB-45
46 1/2" x 3/8"/1181.1x15.9mm	118.99	RHFB-46

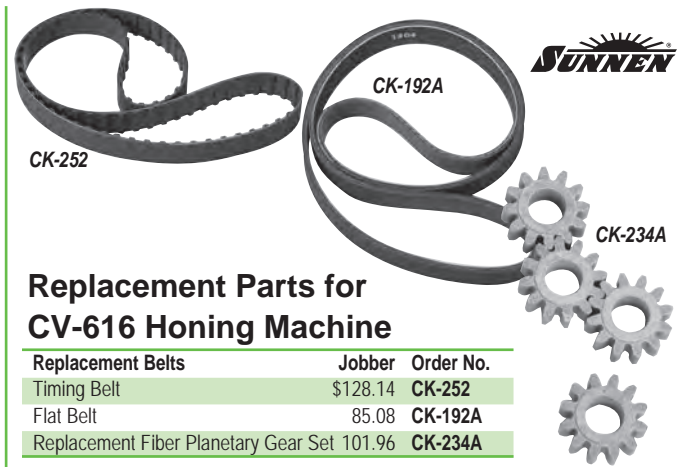

Replacement Parts for CV-616 Honing Machine

Replacement Belts	Jobber	Order No.
Timing Belt	\$128.14	CK-252
Flat Belt	85.08	CK-192A
Replacement Fiber Planetary Gear Set	101.96	CK-234A



Diamond Stone Dresser

- Diamond stone on durable metal tool
- Order No. **MAN-700** Jobber \$90.82

When cutting action of honing stone slows down, a light stroke with the diamond dresser breaks the glaze and restores honing efficiency. Especially recommended for rod reconditioning. Consists of diamond stone on a sturdy metal holder with a chain for fastening it to the honing machine.

tech tips
from the techxperts™

Rod Honing Stones & Mandrels

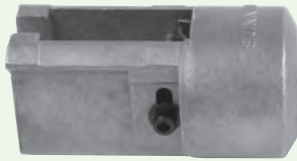

KL-Series Connecting Rod Lifetime Honing Unit Mandrel Adaptor

- Mandrel Adaptor comes with retainer
- Order No. AK20-A Jobber \$42.05

Rod Honing Stones, Guide Shoes & Replacement Parts

- Premium-quality • Choose Goodson or Sunnen®

SL
Stones



HP / PL
Stones

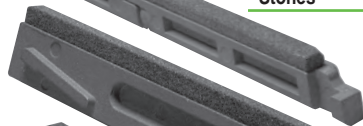

HM / ML
Stones



HK / KL
Stones

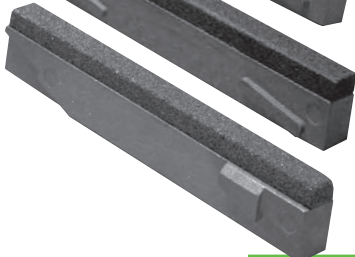

Stones	Use	Goodson			Sunnen®			
		Jobber	Order No.	Qty.	Jobber	Order No.	Sunnen No.	Qty.
For Sunnen® SL720 - SL2300 Mandrel								
	Roughing	---	---		\$102.09	SL-5		6
	General Purpose	---	---		102.09	SL-7		6
	Finishing	---	---		102.09	SL-13		6
For Sunnen® PL Series Mandrel								
	Roughing	\$8.99	HP-5	1	\$84.86	PL-5	P28-J27	12
	General Purpose	8.99	HP-7	1	82.27	PL-7	P28-J47	12
	Finishing	8.99	HP-13	1	84.86	PL-13	P28-J67	12
For Sunnen® ML Series Mandrel								
	Roughing	\$7.99	HM-5	1	\$79.68	ML-5	P20-J25	12
	General Purpose	7.99	HM-7	1	79.68	ML-7	P20-J47	12
	Finishing	7.99	HM-13	1	73.70	ML-13	P20-J67	12
For Sunnen® KL Series Mandrel								
	Roughing	\$7.99	HK-5	1	\$79.68	KL-5	K20-J25	12
	General Purpose	7.99	HK-7	1	76.89	KL-7	K20-J47	12
	Finishing	7.99	HK-13	1	76.89	KL-13	K20-J67	12
	Steel	---	---		76.89	KL-14	K20-A69	12
Bronze Guide Shoes			Jobber	Order No.	Qty.	Jobber	Order No.	Qty.
For Sunnen® KL and ML Series Mandrel								
	.775"-.805"	19.7-20.4mm	---	---		\$44.36	UA-B	2
	.838"-.899"	21.3-22.8mm	---	---		43.03	UB-B	2
	.900"-.993"	22.9-25.2mm	---	---		44.36	UC-B	2
	.994"-1.125"	25.2-28.6mm	---	---		44.36	UD-B	2
	1.119"-1.250"	28.4-31.8mm	---	---		43.03	UE-B	2
Note: Bronze guide shoes outlast die cast 6 to 1.								
Zinc Alloy Guide Shoes			Jobber	Order No.	Qty.	Jobber	Order No.	Qty.
For Sunnen® PL and ML Series Mandrel								
	1.355" - 1.500"	34.4-38.1mm	---	---		\$20.42	WC-D	2
	1.480" - 1.625"	37.6- 41.3mm	---	---		21.02	WD-D	2

Bronze
Guide
Shoes

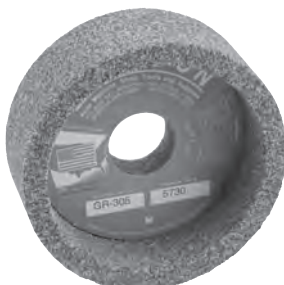

Rod and Cap Grinding Wheels

- Fits Sunnen® Rod and Cap Grinding Machines • Recessed design

Size	Jobber	Order No.
4"x1½"x1"	\$44.99	GR-305
101.6x38.1x25.4 mm		
6"x2"x1¼"	102.99	GR-805
152.4x50.8x31.8 mm		

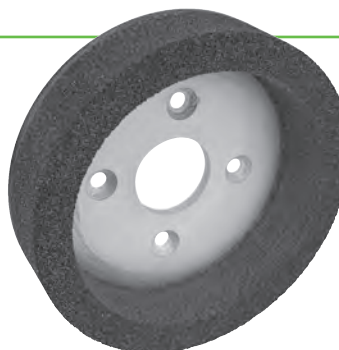

Delta Cap Cutter Premium Grinding Wheel

- Fits Delta Cap Cutter Model #6200XHD
- 7" OD x 1½" thick x 5½" ID
- Plate mounted & balanced for smooth grinding • Ideal for welded main caps
- Order No. GR-6200XHD Jobber \$179.99



Rod & Cap Grinding Wheels

- For Sunnen® and other popular brand cap grinders • Fits CRG 700, 750, 770, 780, 805 & 920K • Softer than GR-805 • 6" x 2" x 1¼"
- Order No. F343793 Jobber \$73.99



CYLINDER HEAD REBUILDING
CLEANING, ASSEMBLY & SAFETY
SHORT BLOCK REBUILDING
CRANKSHAFT/ FLYWHEEL GRINDING
MISCELLANEOUS TOOLS & SUPPLIES
BRAKE SERVICE TOOLING
MEASURING TOOLS
V-TWIN & METRIC HARD PARTS

... another satisfied customer

"This tool works!"

- Dennis Terrill, Terrill Motor Machine, Fort Lauderdale, FL, Goodson customer since 1990

CYLINDER HEAD REPAIRING

CLEANING, ASSEMBLY & SAFETY

SHORT BLOCK REBUILDING

CRANKSHAFT/ FLYWHEEL GRINDING

MISCELLANEOUS TOOLS & SUPPLIES

BRAKE SERVICE TOOLING

MEASURING TOOLS

V-TWIN & METRIC HARD PARTS



Standard Wrist Pin Bushing Driver sizes range from 25mm to 54mm. If we don't have the size you're looking for in the chart below, we can create special drivers. Call the Goodson Techxperts™ at 1-800-533-8010 for more information.



sized for diesel

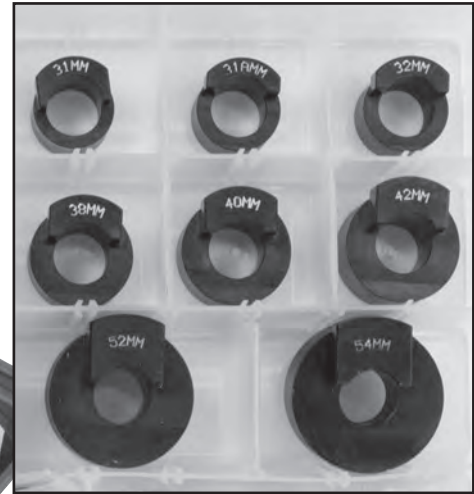

To facilitate installing bushings into connecting rods, chamfer the edges of the connecting rod.

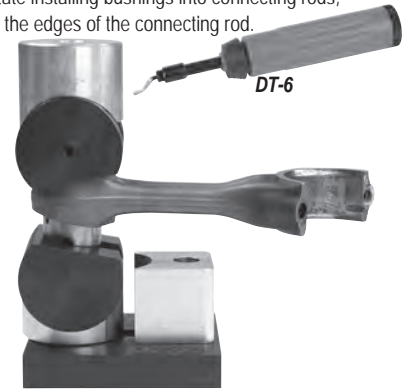

American Made

Universal Tapered Pin Bushing Press Kit For Light & Medium Duty Diesel Engines

This press kit is specially designed to remove and replace tapered bushings in most common light to medium duty diesel applications. Don't spend time making a fixture that's dedicated to a single size. Our Tapered Pin Bushing Press Kit is ready to go when you receive it. All you need is the correct bushing driver to get started.

tech tips

from the techxperts™
When pressing together always press the rod onto the bushing and **NOT** the bushing into the rod. This prevents the bushing from collapsing or folding up.

Choosing A Driver

1. Measure the wrist pin diameter.
2. Select a driver from the chart at right that is .030" to .040" smaller.
3. Measure the thickness of the bushing.
4. Select the driver with a Step size that is 50% to 60% of the bushing thickness.

tech tips from the techxperts™

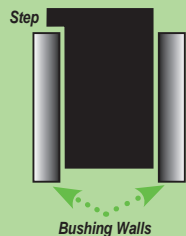

EXAMPLE:
Wrist Pin Dia. 1.185"
Nearest Driver Dia. 1.158"
Bushing Thickness .150"
40% of Thickness 0.090"
Select Bushing Driver **TBD-31**
If your measurements do not correspond to a driver in the chart, call 1-800-533-8010 to inquire about resizing.
Order No. **TBD-RESIZE**
Jobber \$79.99

Description	Jobber	Order No.	Includes
Complete Wrist Pin Bushing Press Kit	\$1399.99	TB-KIT	▼
Wrist Pin Press Base (select drivers below)	749.99	TB-BASE	▼ x
Press Tube - Small (27x21x120mm)	41.79	TPT-SM	x
Press Tube - Large (30x31x110mm)	41.79	TPT-LG	x
Wrist Pin Ring (50x5x20/26mm)	15.99	WPR-001	x
Wrist Pin Parallels (2) 8x10x50mm	27.99	WPP-2	x
Extended Mandrel (8½" long)	89.99	TB-MANDREL	x

Wrist Pin Bushing Drivers sold by dimension, not application

MM	Nominal	Actual	Step	Jobber	Order No.	Includes
25	1.000"	0.957"	0.063"	\$59.99	TBD-25	x
26	1.063"	0.990"	0.058"	59.99	TBD-26	x
27	1.060"	1.032"	0.067"	59.99	TBD-27	x
28	1.100"	1.006"	0.055"	59.99	TBD-28	x
30	1.180"	1.102"	0.075"	59.99	TBD-30	x
31	1.220"	1.158"	0.090"	59.99	TBD-31	x
31	1.220"	1.198"	0.067"	59.99	TBD-31A	x
32	1.260"	1.222"	0.078"	59.99	TBD-32	x
33	1.300"	1.268"	0.068"	59.99	TBD-33	x
34	1.340"	1.304"	0.073"	59.99	TBD-34	x
36	1.420"	1.377"	0.075"	59.99	TBD-36	x
38	1.500"	1.458"	0.076"	59.99	TBD-38	x
40	1.570"	1.554"	0.068"	59.99	TBD-40	x
42	1.650"	1.614"	0.097"	59.99	TBD-42	x
45	1.770"	1.742"	0.089"	59.99	TBD-45	x
46	1.810"	1.772"	0.108"	59.99	TBD-46	x
50	1.970"	1.940"	0.083"	59.99	TBD-50	x
52	2.050"	2.012"	0.114"	59.99	TBD-52	x
54	2.130"	2.099"	0.081"	59.99	TBD-54	x
				12.99	PFL-200*	
Goodson Press Fit Lube (6 oz. Aerosol can)				20.99	DT-6	
Deburring Tool						

*Hazardous Goods Fees Apply When Shipped Air

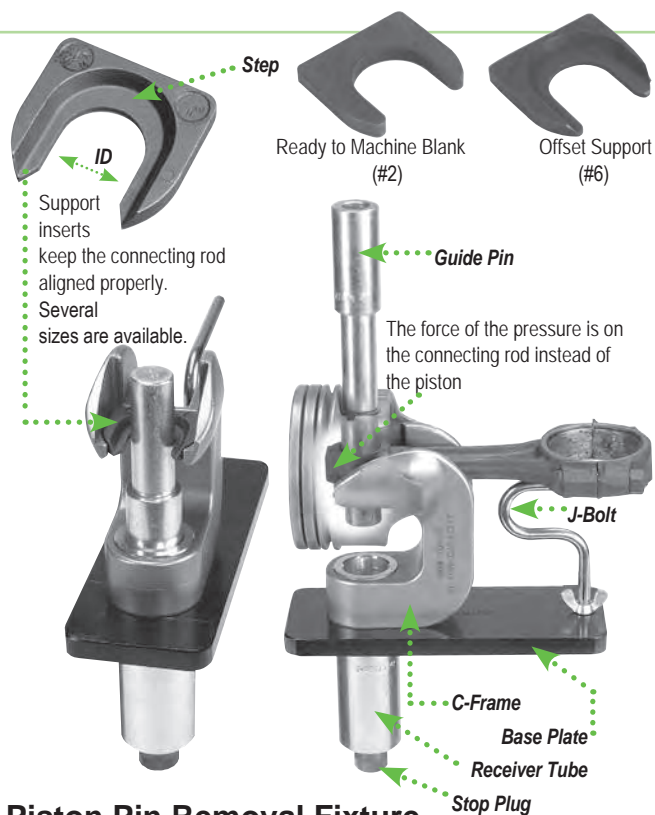

Piston Pin Removal Fixture

- Use to remove or install interference fit piston pins
- Force of removal is against the piston pin and connecting rod – no pressure is exerted on the piston itself
- Tooled to fit most popular engines with pin diameters of 0.859" through 1.087"
- Replacement Support Inserts & Guide Pins sold separately



For Small Block Chevy use Support Insert #1 or Offset #6, for Big Block Chevy, use Support Insert #5, Support #2 is a blank, ready to be machined to your exact specifications.

Description	ID	Step	Jobber	Order No.	Incl.
Complete Kit			\$999.99	PPE-7082	▼
Replacement C-Frame			349.99	PPE-302186	x
Replacement Support Inserts	#1	0.945" .100"	43.99	PPE-39889	x
	#2	1.110" .275"	43.99	PPE-39890	x
	#3	1.000" .182"	43.99	PPE-39888	x
	#4	1.110" .182"	43.99	PPE-39886	x
	#5	1.000" .100"	43.99	PPE-39887	x
	#6	0.945" .100"	43.99	PPE-39822	x
Replacement Guide Pins	0.859"		29.99	PPE-17940	x
	0.897"		29.99	PPE-17936	x
	0.926"		29.99	PPE-17937	x
	0.970"		29.99	PPE-17938	x
	0.992"		29.99	PPE-17939	x
	1.032"		29.99	PPE-17941	x
	1.055"		29.99	PPE-17942	x
	1.087"		29.99	PPE-18729	x

Replacement Parts

J" Bolt (Rear Support)	\$26.99	PPE-302224	x
Wing Nut	1.99	PPE-10588	x
1 1/2" / 30.2mm Stop Plug	41.99	PPE-17830D	x
Base Plate	94.99	PPE-17929	x
Receiving Tube	49.99	PPE-17931B	x
Body Guide	49.99	PPE-17932B	x
5/8" / 139.7mm Spring	8.99	PPE-17934	x
Guide Pin Driver	24.99	PPE-17935	x
1 1/2" / 41.3mm External Spiral Lock	11.99	PPE-17945	x

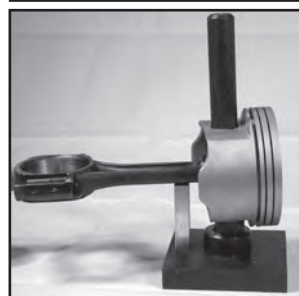

Universal Piston Pin Press-Out Tool

- Use with a shop press
- Top quality steel tooling
- Standard set handles most applications
- You can modify for individual needs

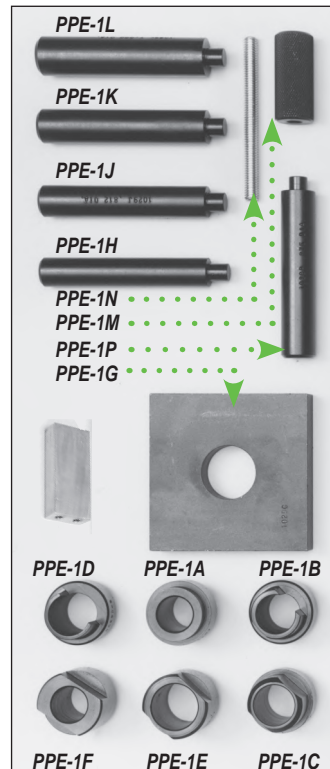

Description	Jobber	Order No.	Incl.
Piston Pin Extractor Kit	\$269.99	PPE-1	▼
Piston Support Fixtures			
.800" hole	23.99	PPE-1A	x
.865" hole	23.99	PPE-1F	x
.950" hole	23.99	PPE-1B	x
1.010" hole	23.99	PPE-1C	x
1.010" hole	23.99	PPE-1D	x
1.110" hole	23.99	PPE-1E	x
Fixture Base Block	\$39.99	PPE-1G	x
Pin Pressing Drifts			
.760" dia.	19.99	PPE-1H	x
.812" dia.	19.99	PPE-1J	x
.875" dia.	19.99	PPE-1K	x
1.000" dia.	19.99	PPE-1L	x
Tapped Handle	17.99	PPE-1M	x
Threaded Rod	8.99	PPE-1N	x
Threaded Adaptor	15.99	PPE-1P	x
Rod Support	18.79	PPE-1GM	x

Kit now includes the rod support for tapered boss pistons

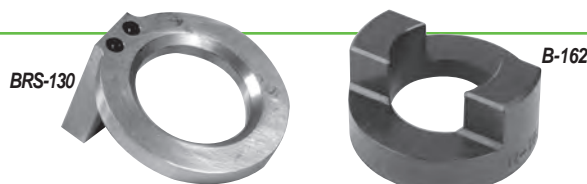

GOODSON Rod Support for Sunnen® Pin Press Tooling

- Remove late model connecting rods from tapered boss pistons
- Aluminum construction prevents connecting rod damage • Fits Sunnen® tooling

Description	Jobber	Order No.
GOODSON Rod Support	\$ 62.99	BRS-130
Sunnen® Reducing Ring	111.56	B-162

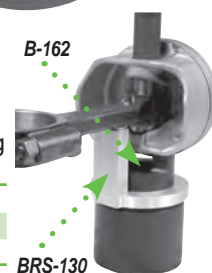

CYLINDER HEAD
REBUILDING

CLEANING,
ASSEMBLY & SAFETY

SHORT BLOCK
REBUILDING

CRANKSHAFT/
FLYWHEEL GRINDING

MISCELLANEOUS
TOOLS & SUPPLIES

BRAKE SERVICE
TOOLING

MEASURING
TOOLS

V-TWIN & METRIC
HARD PARTS



Our easy-to-use, comprehensive catalog features more than 8,000 tools and supplies. Feel free to call if you're not sure what to order or if you have questions. We'll do everything we can to help you get what you need."

- Diane, Goodson Purchasing - 5 years of service

CYLINDER HEAD
REBUILDING
CLEANING,
ASSEMBLY & SAFETY

Piston Installing Deadblow Hammer

- 1-piece design
- Specially formulated, urethane compound is cut and split resistant
- Convex-faced
- Non-mushrooming material
- Offset head
- Ideal for fast, mar-free piston installation
- Weighs 1.7 lbs./.77 kg
- Order No. **PK-200**
Jobber \$51.99



SHORT BLOCK
REBUILDING



Piston Ring Expander

- Remove & install most rings
- Tapered jaws
- 3/64" to 1/4" / 1.2mm to 6.35mm ring width
- Order No. **PRE-500**
Jobber \$14.99

CRANKSHAFT/
FLYWHEEL GRINDING



Band Ring Compressor Kits

- Install rings safely and easily • Hardened steel for durability
- Trigger ratchet mechanism for tight compressions

Description	Jobber	Order No.	Incl.
6 Pc. Band Ring Compressor Kit	\$46.99	GPS-98	▼
9 Pc. Band Ring Compressor Kit	69.99	GPS-99	▼
Compressing Pliers	22.99	GPS-98A	x x
Bands Range in. mm			
1.875" - 2.125"	47.63-53.98	\$12.99 GPS-98Q	
2.125" - 2.375"	53.98-60.33	12.99 GPS-98R	x
2.375" - 2.625"	60.33-66.68	12.99 GPS-98S	x
2.625" - 2.875"	66.68-73.03	12.99 GPS-98T	x
2.875" - 3.125"	73.03-79.38	12.99 GPS-98B	x x
3.125" - 3.375"	79.38-85.73	12.99 GPS-98C	x x
3.375" - 3.625"	85.76-92.08	12.99 GPS-98D	x x
3.625" - 3.875"	92.08-98.43	12.99 GPS-98E	x x
3.875" - 4.125"	98.43-104.78	12.99 GPS-98F	x x
4.125" - 4.375"	104.78-111.13	12.99 GPS-98G	x x
4.500" - 4.750"	114.30-120.65	13.99 GPS-98H	
4.750" - 5.000"	120.65-127.00	13.99 GPS-98I	
5.000" - 5.250"	127.00-133.35	13.99 GPS-98J	
5.250" - 5.500"	133.35-139.70	13.99 GPS-98N	

BRAKE SERVICE
TOOLING

MEASURING
TOOLS

V-TWIN & METRIC
HARD PARTS



Gas Porting Tools for High Performance

- Virtually eliminate side ring clearance by drilling gas ports in your piston ring lands
- These tiny ports apply compression pressure directly to the back of the ring, pushing it against the cylinder wall with greater force while minimizing compression leakage
- Gas ports work best with piston-compression heights of 1.2" or less on engines running at high rpm (7,000 or higher)
- These simple Tool Kits take all of the guess-work out of gas porting and include everything you'll need to get started
- The complete kit includes:
Drill Fixture, Depth Bushing and one Drill Bit

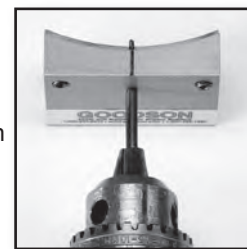

US Patent No. US D617,664 S

Description	Size	Jobber	Order No.
Gas Porting Tool Kits	.043"	\$99.99	GPT-043
	.062" and 1.5mm	99.99	GPT-062
Replacement Drill Bits	.040" for GPT-043	7.99	GPT-040-DB
(5 pack)	.062" for GPT-062	7.99	GPT-062-DB

Minnesota Fast Freeze

- Instantly chills seats and guides to -50°F / -45.5°C
- Creates interference fit with heated aluminum heads
- Finish seat and guide work faster than ever
- Use on tight bushings, pins, shafts, etc.
- Aerosol*
- Order No. **MFF-8*** Jobber \$30.99



*Hazardous Goods Fees Apply When Shipped By Air

Press Fit Lubricants

- A light coat eases press fit
- Ideal for valve guides, piston pins, cylinder sleeves, etc.
- Eliminates the scoring, gouging and galling of parts during press fitting



Description	Jobber	Order No.
Goodson Aerosol 6 oz. (170 g)	\$12.99	PFL-200*
Sunnen® Aerosol 7 oz. (198 g)	18.06	B-200*
Sunnen® Brush Applicator 200 mL (not shown)	24.59	B-200L

*Hazardous Goods Fees Apply When Shipped By Air

Buy 12 or more PFL-200 and SAVE 10% off jobber



Introduced in 2003!

Rod & Piston Work

American Made

The Original Goodson Powered Ring Filers

- No more tedious filing and checking and filing and checking to get desired end gap; set it once and cut multiple rings
- Easy to read integral dial indicator and positive ring stop make repeatable precision quick and easy
- Fits 2 1/2" to 5" / 63.5 to 127mm diameter rings
- Adjustable guide holds rings square to the cutting wheel
- Table pivots past cutting wheel
- No open ways to gather grinding dust that causes premature wear
- Handy knurled in-feed adjustment knob • High torque motor

Diamond Dresser is securely held in place by the ring clamping pin

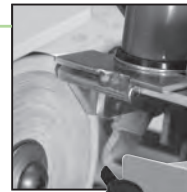

Lighted Rocker Switch

Built-in deburring wheel eliminates the need to hand hone or deburr rings after filing

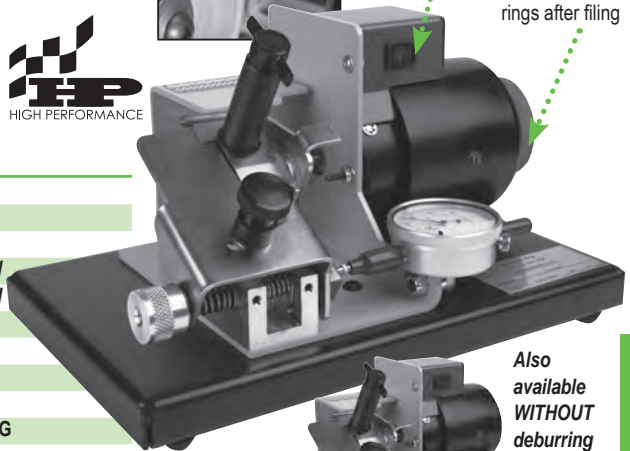

Also available WITHOUT deburring wheel

Description	Jobber	Order No.
Powered Ring Filer 110V / 60 cycle w/o Deburring Wheel	\$699.99	PRF-812
Powered Ring Filer 220V / 50 cycle w/o Deburring Wheel	729.99	PRF-822
Powered Ring Filer with Deburring Wheel 110V / 60 cycle	899.99	PRF-812DW
Powered Ring Filer with Deburring Wheel 220V / 50 cycle	929.99	PRF-822DW
Replacement Deburring Wheel	39.99	PRF-DW
2 1/2" Replacement Grinding Wheel (60 grit) for pre-2008 models	9.99	PRF-1001
3" Replacement Grinding Wheel (60 grit)	9.99	PRF-1002
Replacement Diamond Dresser	32.99	PRF-812D
Replacement Table Spring	24.99	PRF-SPRING
Sun-Dura® Canvas Machine Cover	29.99	GMC-PRF

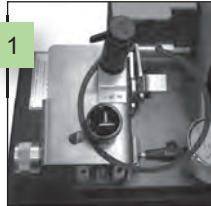

1 Stainless Steel Table

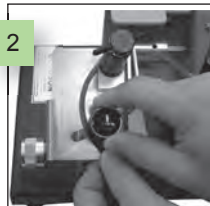

2 Eccentric adjusts quickly and easily

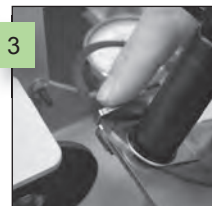

3 Positive ring stop

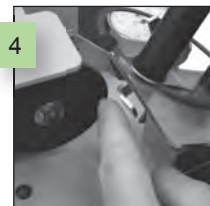

4 Table pivots past grinding wheel



GMC-PRF

Manual Ring Grinder

- Produce end gap rings squarely
- Heavy duty aluminum casting
- Precisely machined for long life
- Silicon-carbide wheel holds shape and produces clean precise cuts
- Includes 1 grinding wheel (replacements available)
- Wheel measures 2 1/2" OD x 7/16" ID x 1/8" thick

Description	Jobber	Order No.
Piston Ring Grinder	\$99.99	PRF-250
Replacement Wheel	16.99	PRF-250W

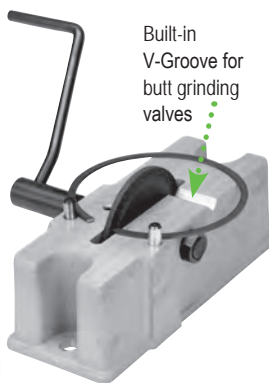

Built-in V-Groove for butt grinding valves

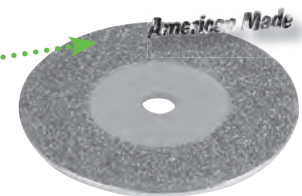

Manual Ring Grinder

- Universal design lets you grind almost any make, type or size of piston ring • Includes diamond abrasive wheel measuring 2" OD x 1/4" ID x 1/16" Thick

Description	Jobber	Order No.
Universal Piston Ring Filer	\$71.99	PRF-500
Replacement Diamond Abrasive Wheel	46.99	PRF-870-DW

Fine Abrasive Stick

- Radiused for easier ring deburring after end gapping
- 4" L x 1/2" radius / 101.6mm x 12.7mm
- Works on all types of rings
- Works on ring ID radii
- Order No. **RS-103**
Jobber \$30.99



tech tips

from the techxperts™
Fine Abrasive Sticks work great for deburring the ends of piston rings after filing, or any part that needs deburring. For a finer finish, soak the abrasive stick in Lapping Oil (LP-LO-4).

Stay Up-To-Date With Your Friends At Goodson!

We're On Social Media Are You?



Facebook

Twitter

Instagram

YouTube

Blog

CYLINDER HEAD REBUILDING
CLEANING, ASSEMBLY & SAFETY
SHORT BLOCK REBUILDING
CRANKSHAFT/ FLYWHEEL GRINDING
MISCELLANEOUS TOOLS & SUPPLIES
BRAKE SERVICE TOOLING
MEASURING TOOLS
V-TWIN & METRIC HARD PARTS

... another satisfied customer



"All of the business I have done with Goodson has been excellent. My sales rep is very helpful, polite and courteous. My rating of her and your tech staff on a scale of 1 to 10 is a 12! Keep up the good work."

- Richard Stokes, Carquest, Winchester, Virginia, Goodson customer since 1990

CYLINDER HEAD REBUILDING
CLEANING, ASSEMBLY & SAFETY

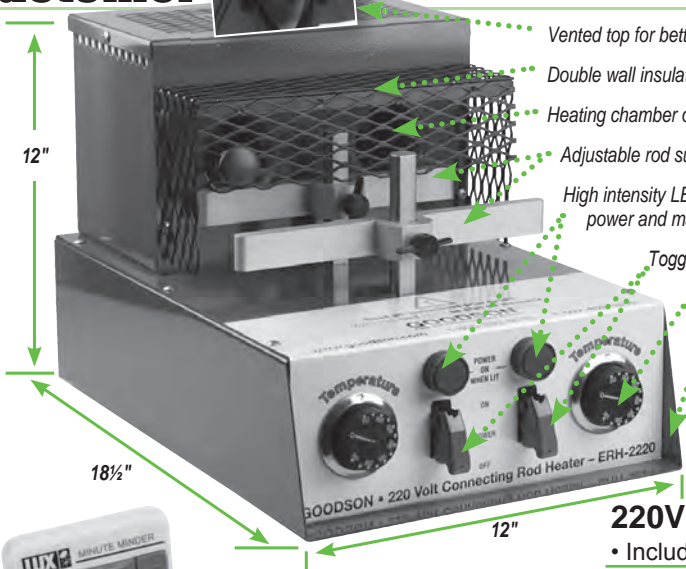

- Vented top for better performance
- Double wall insulated heat chambers with safety screen covering
- Heating chamber opening measures 2 1/8" to fit standard eyes
- Adjustable rod supports to accommodate most automotive connecting rods
- High intensity LED lamps tell that elements have power and may be hot
- Toggle switches with flip-up covers to prevent accidental activation
- Elements operate on separate thermostats
- Powder-coated, heavy-gauge steel housing for long life
- Non-slip rubber feet provide stability

Goodson
exclusive

220V, Single-Phase Electric Rod Heater

• Includes a digital timer and 450° temperature crayon

Description	Jobber	Order No.	Incl.
220V, 50/60 Hz Single Phase Electric Rod Heater	\$1299.99	ERH-2220	▼
Digital Read-Out Timer (battery included)	21.99	ERH-TIMER	x
Replacement Toggle Switch (ea.)	19.99	ERH-SWITCH	
Replacement Toggle Switch Guard (ea.)	49.99	ERH-TSG	
Replacement Thermostat (ea.)	99.99	ERH-THERM	
Replacement Coil (ea.)	89.99	ERH-COIL	
Replacement LED Light Assembly (ea.)	49.99	ERH-LED	
Replacement Bezel Knob (ea.)	16.99	ERH-KNOB	
Replacement Thumbscrew (ea.)	8.99	ERH-TST	
450° Melting Point Temperature Indicator Crayon	19.49	TIC-450	x
Piston Pin Installation Fixture	92.49	PIF-25	

SHORT BLOCK REBUILDING



American Made

Use with our Piston Pin Installing Fixture (PIF-25) sold separately (see page 89 for a complete description).



WorldwideShipping

CRANKSHAFT/ FLYWHEEL GRINDING

MISCELLANEOUS TOOLS & SUPPLIES

Assemble 8 rods & pistons in as little as 5 minutes

Gas-Fired Rod Heater

- Needs no warm-up time – start assembling rods and pistons almost immediately
- Heats piston pin ends so fast that the rest of the rod stays cool
- Minimal cool down time after assembly
- Ceramic lined enclosure contains flame, keeping hands safe
- One knob controls the pilot and gas flow, another sets air flow for ideal combustion
- Burner lights easily with a striker (not included)
- No heat coils to burn out or circuitry to fail
- Includes one 600°F Temperature Crayon (see right)
- Propane model includes gas regulator and hose assembly
- Natural Gas model hooks up to your natural gas service

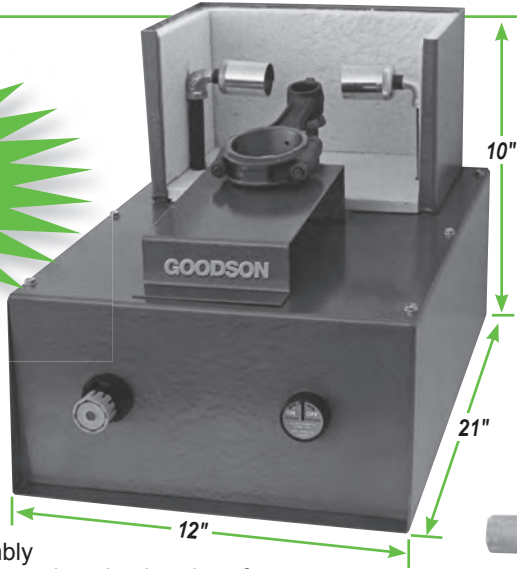

Gauntlet Style Heat & Flame Resistant Gloves

- Heavy, lined red terrycloth
- 13 1/2" Long
- Safe to 450°F / 232.2°C
- Order No. **HFR-300**
- Jobber \$30.99



Temperature Indicating Crayons

- Mark the workpiece before heating
- Melts when temperature is reached
- 3 melting points to choose from

BRAKE SERVICE TOOLING

MEASURING TOOLS

V-TWIN & METRIC HARD PARTS

American Made
WorldwideShipping

Description	Jobber	Order No.
Rod Heater for Propane	\$939.99	RH-50
Rod Heater for Natural Gas	939.99	RH-50N
600°F Temperature Crayon	19.49	TIC-600

Melting Point	Jobber	Order No.
450°F / 232.22°C	\$19.49	TIC-450
500°F / 260.00°C	19.49	TIC-500
600°F / 315.56°C	19.49	TIC-600

Works great with Rod Heaters on previous page!

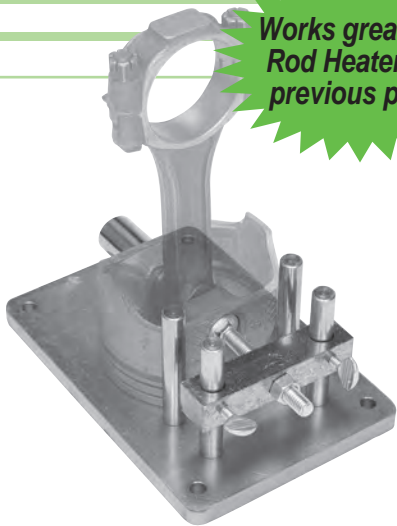

Piston Pin Installing Fixture

- Adjustable stops prevent over-centering rods
- Adjust the stop once and you're ready to assemble a full set of rods
- Base is pre-drilled to mount to a workbench
- Order No. **PIF-25**
Jobber \$92.49



Rod Bolt Boots

- Plastic boots protect crank journals & rod bolts during piston installation
- Save crank journals from rod bolt damage
- Don't risk your reputation for quality
- Reusable
- Set of 16
- Order No. **RBP-16**
Jobber \$7.99

Rod Clamping Vise

- Align rods and caps perfectly
- Smooth jaws won't damage connecting rods like an ordinary vise
- Clamp rods firmly to align parting faces while torquing rod bolts
- Clamp in a vise or bolt to a workbench
- Order No. **RCV-20**
Jobber \$147.99

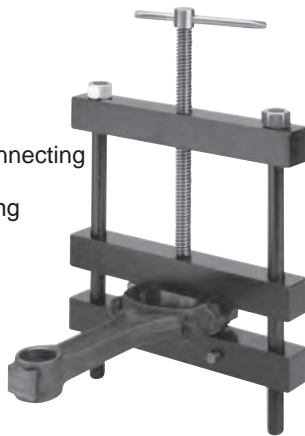

Heavy-Duty Rod Bolt Installing Block

- Mount universal block in a vise to support rod while installing bolts
- Hardened aluminum won't slip
- If the top wears, you can restore it with a file or belt grinder
- Ream holes larger to accommodate oversized bolts
- Order No. **RB-50**
Jobber \$44.99



Connecting Rod not included

The best engine pre-lube tank in the industry!



American Made



Improved ON/Off Ball Valve



Built-in pressure gauge shows tank pressure



Patent-pending Filler Cap. Designed to safely release any pressure left in tank after draining.

10 Quart Engine Pre-Lube Tank

- 10 quart capacity is big enough for all but monster engines
- Corrosion-resistant aluminum tank eliminates contamination from rust • Large 1 3/4" diameter filler hole lets you pour oil right from the bottle - no funnel required • Includes 3 fittings (1/4"x1/4", 1/4"x1/8" and GM LS-1) • Replacement Parts available

Description	Jobber	Order No.
10 Quart Pre-Lube Tank	\$279.99	EPL-110
Replacement 8' Hose	41.99	EPL-HOSE
LS1 Fitting	29.99	EPL-LS1
1/4" Replacement Fitting	4.99	EPL-14
1/8" Replacement Fitting	4.99	EPL-18
Replacement Gauge	12.99	EPL-CG
Replacement Cap Gasket (only for discontinued EPL-120)	12.99	EPL-G
Mini Ball Valve	15.99	EPL-MBV



8' long, 1/4" diameter hose gives you lots of length to work with

CYLINDER HEAD REBUILDING
CLEANING, ASSEMBLY & SAFETY
SHORT BLOCK REBUILDING
CRANKSHAFT/FLYWHEEL GRINDING
MISCELLANEOUS TOOLS & SUPPLIES
BRAKE SERVICE TOOLING
MEASURING TOOLS
V-TWIN & METRIC HARD PARTS



Technology has merely provided us with more efficient ways to give you, our customers, the quality of service you deserve! Our goal is to make ordering shop supplies faster & easier for you, whether you order by phone or through our website."

- Cheryl, Goodson Computer Systems Analyst - 24 years of service

CYLINDER HEAD REBUILDING
CLEANING, ASSEMBLY & SAFETY

Oil Gallery Plug Installer / Staker

- Set depth and lock plug in a single step
- Arbor nose aligns cup plug, then follows with two 180° staker lugs to set depth and lock oil gallery plug securely in place
- Use with Oil Gallery Plugs below
- Order No. **ST-SB**
Jobber \$51.99

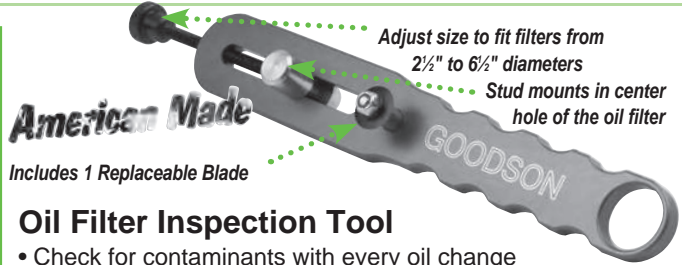

Includes 1 Replaceable Blade

Oil Filter Inspection Tool

- Check for contaminants with every oil change
- Cut open the filter canister for inspection
- Fits 2 1/2" to 6 1/2" diameter filters
- Includes a single blade

Description	Jobber	Order No.
Oil Filter Inspection Tool	\$54.99	FIT-1-G
Replacement Cutter Blade	12.99	FIT-W

SHORT BLOCK REBUILDING

Oil Gallery Plugs

- Replace lost or damaged originals
- 1/4" pipe plugs
- For use at the rear of Small Block Chevy oil galleries or other engines with similar size plugs
- 25 per box
- Order No. **OP-250**
Jobber \$7.99

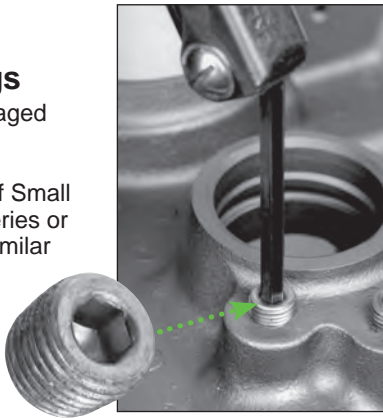

Oil Pump Pickup Tube Driver

- For all GM pumps
- Replace pickup tubes easily with a light mallet
- Driver grips the pickup tube flare
- Gives control for fast alignment and installation

Application	Tube OD	Jobber	Order No.
Small Block	5/8" 15.9mm	\$31.99	TI-25
Big Block	3/4" 19.1mm	31.99	TI-30



CRANKSHAFT/ FLYWHEEL GRINDING

Oil Gallery Brushes

Steel Wire	Jobber	Order No.	Incl.
3-pc. Kit			
Size Length	\$16.99	OGB-SK	▼
1/4" x 3" 24"	7.99	OGB-1	x
3/8" x 3" 24"	8.99	OGB-2	x
5/8" x 3" 24"	9.99	OGB-3	x
Nylon Bristle			
5-pc. Kit	\$27.99	OGB-KIT	▼
Size Length			
3/8" x 3" 34"	6.99	OGB-38	x
1/2" x 2 1/2" 34"	6.99	OGB-42	x
5/8" x 3" 34"	6.99	OGB-5	x
3/4" x 3" 34"	7.99	OGB-7	x
3/4" x 3" 40"	8.99	OGB-8	x

Buy 10 or more brushes (any combination), take 10% off jobber! More brushes on page 62.

MISCELLANEOUS TOOLS & SUPPLIES

TOOLING



Oil Gallery Plug Removers

- Power plugs out with an impact wrench
- Threaded plug inside prevents bit from backing into the holder
- 1/2" drive – fits impact wrenches
- Hardened tool-steel holder with lifetime breakage guarantee
- Tool-steel bit can be reground or replaced
- Set screw holds bit firmly in place



Description	Size	Jobber	Order No.	Incl.
Plug Remover Kit	in mm	\$159.99	PPS-KIT	▼
Replacement Tool	3/16" 4.76	39.99	PPS-187	x
Tool includes	1/4" 6.35	39.99	PPS-250	x
bit (except PPS-281)	9/32" 7.14	41.99	PPS-281*	x
	5/16" 7.94	39.99	PPS-312	x
	3/8" 9.53	39.99	PPS-375	x
Replacement Bits	3/16" 4.76	\$11.99	PPS-187B	
	1/4" 6.35	11.99	PPS-250B	
	5/16" 7.94	11.99	PPS-312B	
	3/8" 9.53	11.99	PPS-375B	

NOTE: *No bit is needed for PPS-281 (square socket).

MEASURING TOOLS

V-TWIN & METRIC HARD PARTS



Oil Gallery Wax

- Preheat the part to be removed, apply wax to its base, allow to cool and remove the part
- 100% natural beeswax
- Measures 1" x 3/4" x 3" • Weighs 1 oz.
- Order No. **BWS-1** Jobber \$4.99



High Performance Lifter Bore Burnishing Tool Kits

- Sized for high performance aluminum blocks such as Top Fuel or Top Alcohol Dragsters and Funny Cars

Description	Jobber	Order No.	Incl.
.625" Set	\$129.99	LBB-625-KIT	▼
1.000" Set	129.99	LBB-1000-KIT	▼
15" Slide Shaft	19.99	LBB-1	x x
Slide Hammer	22.99	GAO-2	x x
Lifter Bore Burnishing Balls			
1.0000" dia.	59.99	LBB-1.000	x
1.0010" dia.	59.99	LBB-1.001	x
1.0625" dia.	59.99	LBB-1.0625	x
1.0635" dia.	59.99	LBB-1.0635	x
Accessories			
Jam Nut	8.99	LBB-NUT	x x
Storage Case	24.99	TRADE-MCB	x x
Lifter Bore Brushes.			
7/8" (.875") dia.	7.49	LBB-875	
1" (1.00") dia.	8.99	LBB-100	x
1 1/8" (1.125") dia.	8.49	LBB-1125	x

... another satisfied customer

"Along with the slide hammer set, the lifter bore burnishing tool fixes tight lifter bores, even on assembled bottom ends quick and easy!! My last race motor build was going great until I noticed a few of my new lifters were real tight at the bottom of the bore.

This tool resized the bores fast and accurate even with the cam still in place. Due to the method of resizing, the entire block isn't contaminated with debris like a hone would do, and saves time and money."

- Grant Farmer, Grand Island, NY, Goodson Customer since 2018



Lifter Bore Burnishing Tool

- Eliminates burrs caused by shot blasting
- Drive the burnishing tool into the bore with a soft hammer, then slide-hammer it back out
- 60Rc burnishing balls deburr faster
- Won't oversize the bore

Description	Jobber	Order No.
Full Kit:	\$154.99	LBB-1500
Slide Shaft	14.99	GAO-1
Slide Hammer	22.99	GAO-2
Jam Nut	8.99	LBB-NUT
Lifter Bore Burnishing Balls		
Complete Set	\$119.99	LBB-3SET
GM .845" dia.	39.99	LBB-GM1
Ford .876" dia.	39.99	LBB-FO1
Chrysler .906" dia.	39.99	LBB-CR1

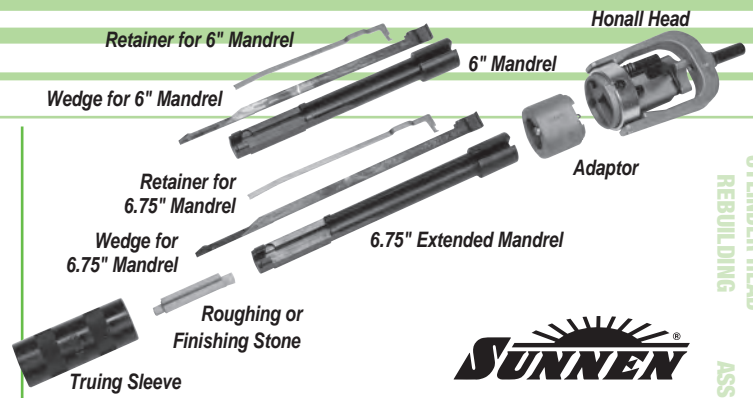

Sunnen® Lifter Bore Hones

- Restore bore size and finish after shot blasting
- Install oversize lifters for high-performance
- Stones work in cast iron bores or ones sleeved with brass or steel
- Wide stones contact a large area giving better stability for hand honing
- Cross oil ports without catching
- Wedge-type adjustment is a simple, positive way to expand or contract the stone to the precise size needed
- Use a 3/8" (9.5mm) or 1/2" (12.7mm) hand-held electric or air drill at approx. 200 RPM
- Use with honing oil
- **All parts MUST be ordered separately to make a complete unit**

tech tips
from the techxperts™

NOTE: Wedges may come with a tab that must be removed **BEFORE** using them with the P-180 Head

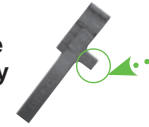

Description	Jobber	Order No
Honall Head	\$381.88	P-180
Adaptor	74.99	PAK20-A
Roughing Stone (280 Grit) 12/box	90.04	Y20-J67
Finishing Stone (400 Grit) 12/box	87.45	Y20-J87

Standard Lifter Bore Tooling (6" Reach)		
Mandrel	.838" - .869" Range	\$377.05 AAY20838BH6LH
	.869" - .900" Range	377.05 AAY20869BH6LH
Wedge		70.70 Y20-W-6LH
Retainer		43.03 LN-3688A-6LH
Truing Sleeve	.838" - .869" Range	21.51 S-838
	.869" - .900" Range	22.18 S-869

Extended Reach Lifter Bore Tooling (6 3/4" Reach)		
Mandrel	.838" - .869" Range	\$377.05 AAY20838675LH
	.869" - .900" Range	377.05 AAY20869675LH
Wedge		72.81 Y20-W-675LH
Retainer		44.36 LN-3688A675LH
Truing Sleeve	.838" - .869" Range	21.51 S-838
	.869" - .900" Range	22.18 S-869



Rod Honing Oil

- Includes additives for high pressure cutting
- Keeps stones clean and free-cutting during rod reconditioning, pin fitting and other honing applications
- Will mix with other honing oils (including Sunnen®)

Size	Jobber	Order No.
1 Gal. (3.78L)	\$ 34.99	RHO-10
5 Gal. (18.9L)	174.99	RHO-50

CYLINDER HEAD REBUILDING
CLEANING, ASSEMBLY & SAFETY
SHORT BLOCK REBUILDING
FLYWHEEL, GRINDING
CRANKSHAFT/ MISCELLANEOUS
TOOLS & SUPPLIES
BRAKE SERVICE
MEASURING TOOLS
V-TWIN & METRIC HARD PARTS

... another satisfied customer

"It's a pleasant surprise to deal with a company that obviously cares about customer service. Your website was easy to use and order feedback assuring. Keep up the good work."

— Norm Cameron, St. Petersburg, FL, Goodson customer since 2017

CYLINDER HEAD REBUILDING
CLEANING, ASSEMBLY & SAFETY
SHORT BLOCK REBUILDING
CRANKSHAFT/ FLYWHEEL GRINDING
MISCELLANEOUS TOOLS & SUPPLIES
BRAKE SERVICE TOOLING
MEASURING TOOLS
V-TWIN & METRIC HARD PARTS



new

Powder Coated Steel Storage Rack Included with kit purchase

Universal Cam Bearing Tool

- Remove and install hundreds of sizes of cam bearings with just four mandrels!
- Expanding Mandrels cover a 1.370"-2.250" range
- Adjusts to undersize bearings so you can remove and install them from virtually any block
- Interchangeable with Dura-Bond

Description	Jobber	Order No.	Incl.
Universal Cam Bearing Tool	\$504.99	CBT-300	▼
Replacement Segment with Sleeve			
Max Dia. 1.370"	\$ 57.99	CBT-5M	x
1.682"	57.99	CBT-6M	x
1.875"	62.99	CBT-7M	x
2.250"	68.99	CBT-8M	x
Replacement Backing Plate			
Max Dia. 1.370"	\$ 15.99	CBT-5W	x
1.682"	17.99	CBT-6W	x
1.875"	18.99	CBT-7W	x
2.250"	19.99	CBT-8W	x
Replacement Neoprene Sleeve			
Max Dia. 1.370"	\$ 7.99	CBT-5NS	x
1.682"	9.99	CBT-6NS	x
1.875"	9.99	CBT-7NS	x
2.250"	11.99	CBT-8NS	x
Drivers			
Length 5" (pictured above)	\$ 54.99	CBT-1B	x
24"	108.99	CBT-2B	x
36" (pictured above)	139.99	CBT-3B	x
48"	149.99	CBT-4B	x
Miscellaneous Replacement Parts			
1 1/16" Expander with stud	\$ 58.99	CBT-3E	x
1 5/8" Expander with stud	55.99	CBT-4E	x
1/2"x13 Stud	12.99	CBT-1S	x
Guide Cone	32.99	CBT-1C	x
Threaded Impact Cap (New Style)	46.99	CBT-300-CAP	x
Steel Storage Rack	79.99	CBT-300-WR	x

INTERCHANGEABLE WITH DURA-BOND

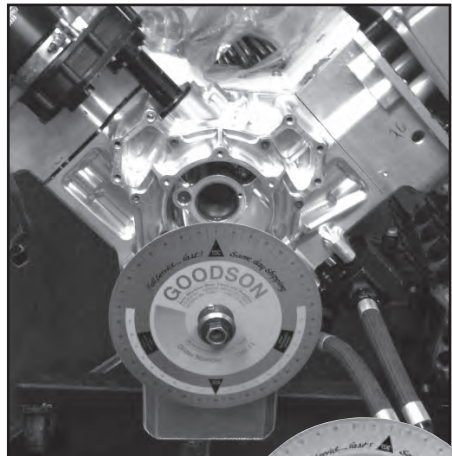

This is one of those customer... another satisfied customer
MUST have tools for the shop and trailer. We have needed our Goodson Degree wheel at the track a few times and in a few minutes we are done and ready to go! Thanks again great equipment.
 — Dean Dubbin, DMP Awnings (NHRA Top Alcohol Dragster), Goodson customer since 2010

Degree Wheel

- Check cam timing, duration and overlap
- Degree wheel measures 11" / 279.4mm dia. with 1 7/8"/47.6mm hole
- Small ID Adaptor Kit mounts it to cranks using 7/16" to 3/4" fasteners or use the turning tool for that engine to mount the wheel
- Use with 1/2" drive ratchet

Wheel / Adaptors	Jobber	Order No.	Incl.
Automotive Degreasing Kit	\$59.99	DW-KIT-2	▼
Degree Wheel	29.99	DW-11	x
Small ID Adaptor Kit	15.99	DW-MK2	x

Lifting Sling

- Lift up to 1800 lbs. (816.5 kg) safely and easily
- 1" x 36" (25.4x914.4mm) looped sling
- Secure the sling to the workpiece and move it with your overhead hoist
- Durable, nylon webbing
- Not for use with caustics or temperatures exceeding 190°F / 87.8°C
- Order No. **LS-3** Jobber \$11.99

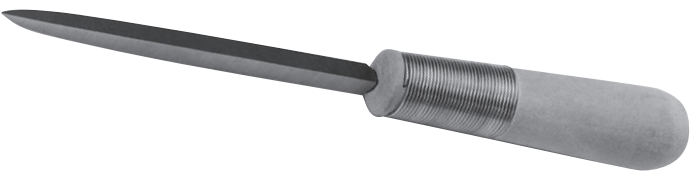

Bearing Scraper

- Eliminate bearing high spots after installation to assure correct oil clearance
- Solid, wire wound, wood handle for strength and resistance to splitting
- 4" / 101.6mm blade with 3 cutting edges
- Order No. **BS-30** Jobber \$26.99

Whether you're regrinding cores for stock applications or custom grinding for diesel and high performance, you can count on Goodson Cam Grinding Wheels to deliver an excellent finish

Goodson abrasives are second to none. We work with our manufacturer to get you the most ideal grain that's bonded to be free-cutting, yet still shed before loading up. Our Premium wheels are ideal for steel high performance camshafts of 55 to 65 Rc and for Stellite overlays. Goodson finishes all Camshaft Grinding Wheels to your specifications in-house for faster turn-around and delivery. Choose from the sizes below or custom order your cam wheel today!



Cam Grinding Wheels - WAA54-L5V1

Diameter	Width	Arbor	Jobber	Order No.
18"	3/4"	19mm	6" 152mm	\$199.99 E341420
457mm	7/8"	22mm	6" 152mm	207.99 E335351
	1"	25mm	6" 152mm	207.99 E335352
	1 1/8"	29mm	6" 152mm	229.99 E335353
	1 1/4"	32mm	6" 152mm	229.99 E335354

Cam Grinding Wheels - 43A602-K8-V1

18"	3/4"	19mm	6" 152mm	\$187.99 E342030
457mm	7/8"	22mm	6" 152mm	194.99 E339945
	1"	25mm	6" 152mm	207.99 E342031
	1 1/4"	32mm	6" 152mm	229.99 E348558

Cam Grinding Wheels - 7BL801

18"	3/4"	19mm	6" 152mm	\$309.99 E416880
457mm	7/8"	22mm	6" 152mm	309.99 E427392

Due to the manufacturing process, actual colors may vary

Cam Grinding Wheels - WAA100

18"	3/4"	19mm	6" 152mm	\$207.99 E379225
457mm	7/8"	22mm	6" 152mm	209.99 E397667
	1 1/4"	32mm	6" 152mm	229.99 E416183

Standard Goodson Cam Grinding Wheels - 100 grit

Diameter	Width	Arbor	Jobber	Order No.
18"	3/4"	19mm	6" 152mm	\$164.99 GCC 18 x 0.750 x 6
457mm	7/8"	22mm	6" 152mm	164.99 GCC 18 x 0.875 x 6
	1"	25mm	6" 152mm	194.99 GCC 18 x 1.000 x 6
	1 1/8"	29mm	6" 152mm	229.99 GCC 18 x 1.125 x 6
	1 1/4"	32mm	6" 152mm	229.99 GCC 18 x 1.250 x 6

All Radiac Camshaft Grinding Wheels are the same grit, grain and bond that you have ordered in the past.

Torque-Angle Indicator

- When torque is given as degrees of turn past a certain ft./lb., use this gauge to show degrees
- 1/2" square drive
- Hold metal base with one hand
- Plastic dial turns as you tighten
- Fits between a drive extension and the socket
- Order No. **TQR-4554** Jobber \$21.69

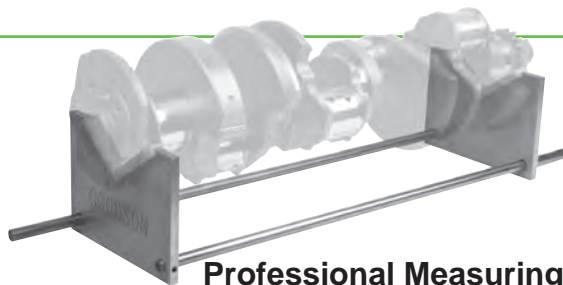

Professional Measuring & Inspection Stand For Cranks & Cams

- Length adjusts up to 23" to fit journal spacing
- Rotate work to view or measure
- Solid aluminum frame with self-lubricating, corrosion and chemical-resistant wear surfaces
- Order No. **PMIS-30** Jobber \$124.99

Bore Washing Brushes

- Clean tunnel housing bores and full-annular grooved area
- Heavy, hand-driven shank

Dia.	Length	Jobber	Order No.
2"	36"	\$19.99	CBB-200
2 1/4"	36"	20.99	CBB-225
2 1/2"	36"	21.99	CBB-250
2 3/4"	18 1/2"	19.99	CWB-27W
3 1/2"	18 1/2"	19.99	CWB-35
4"	18 1/2"	19.99	CWB-40
4 1/2"	18 1/2"	21.99	CWB-45
5"	18 1/2"	22.99	CWB-50



Buy 10 or more brushes (any combination), take 10% off jobber! More brushes on page 62.

Cam Bearing Flex-Hones®

- Silicon-Carbide globules laminated to high density nylon
- Includes 18" drive rod
- 180 grit

Buy 3 or more Flex-Hones® (any combination), SAVE 10% off jobber. More Flex-Hones® on page 72.



Inch	mm	Jobber	Order No.
1 3/4"	45	\$45.99	CBF-175
2"	51	47.99	CBF-200
2 1/4"	57	49.99	CBF-225
2 1/2"	64	54.99	CBF-250
2 3/4"	70	59.99	CBF-275

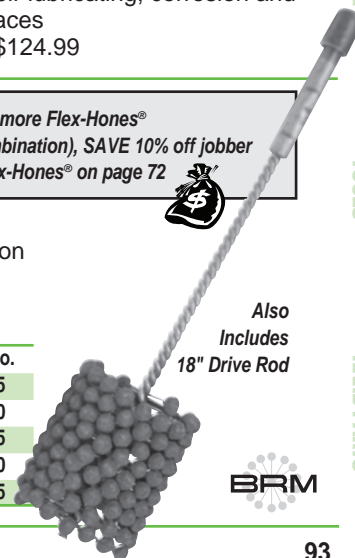

Also Includes 18" Drive Rod



CYLINDER HEAD REBUILDING
CLEANING, ASSEMBLY & SAFETY
SHORT BLOCK REBUILDING
CRANKSHAFT/FLYWHEEL GRINDING
MISCELLANEOUS TOOLS & SUPPLIES
BRAKE SERVICE TOOLING
MEASURING TOOLS
V-TWIN & METRIC HARD PARTS

full service
...fast



"The Mach-B division of Goodson offers many services such as ANSI compliant speed testing, balance testing, grinding wheel shaping, resizing and more. Find out more at Mach-B.com."
- Jon, Goodson Production, 37 years of service

Goodson crankwheels are made-to-order in-house

Other sources stock finished wheels, which makes it virtually impossible to stock a full range of sizes. If they don't have what you need, they may charge more and delay your order for weeks. That's why Goodson makes every wheel to order. We always have the right wheel because we take a Type 1 straight wheel, size it, shape it, speed test it and ship it.



For future reference write down your

Crank Wheel Number (s)

Select the shape



Hub

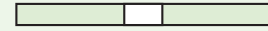

Straight

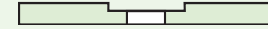

Recessed 1 Side

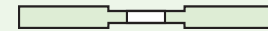

Recessed 2 Sides



Tapered

Select your wheel grade:

WAA Superior Grade - 54 grit
Excellent dimensional accuracy, corner radii and surface finish. For multiple applications including weld grinding. Ideal for grinding everything from cast iron to steel. Finishing and roughing wheel. Aluminum-oxide abrasive for light to medium stock removal.



GCH Superior Grade - 54 grit
Better form holding ability, cuts cooler and needs less dressing. Use on crank journals with Rockwell hardness of 35 Rc or less. Use on crankshafts of cast or forged steel, Nodular iron. Ideal for large radii, thrust and plunge grinding. Great for high-performance.



GCD Premium Grade - 60 grit
For harder materials. Good form holding ability; cuts cooler and needs less dressing. Grains yield faster, cooler grinding. Use on journals with Rockwell hardness of 35 Rc or more. Ideal for diesel, high-performance, industrial and billet steel.



Increase coolant flow with Crankwheel Slotting

Slotting facilitates the flow of coolant to the thrust and radius areas of the crankshaft. Don't waste time waiting on other suppliers who outsource their crankwheels for slotting – Goodson has a shop full of equipment, so we slot wheels in house!

How to order:

If you have any questions, please call 1-800-533-8010

Grade	Diameter	Face Width	Arbor Size	Machine	Shape
WAA - Superior	Diameters are available from 18" to 36" in most grades.	Most sizes from 3/4" to 2 5/8" (custom widths are no extra charge).	Arbor size of your grinder. Any arbor hole from 3" to 12".	Identify the make and model of your grinder.	We send the standard shape for your grinder unless you specify otherwise.

Enter your information below, then call Goodson at 1-800-533-8010 to order

Grade x Diameter x Face Width x Arbor Size x Machine x Shape

Please note, all wheels are delivered up to .015" oversize to allow for side dressing when mounting

CRANKSHAFT/
FLYWHEEL GRIND

MISCELLANEOUS
TOOLS & SUPPLIES

BRAKE SERVICE
TOOLING

MEASURING
TOOLS

V-TWIN & METRIC
HARD PARTS

Crankshaft Grinding Wheels



Dia.	Face Width	WAA Jobber	GCH Jobber	GCD Jobber
Fits Storm Vulcan 14, 15				
18"	¾"-1"	\$221.99	\$224.99	call
3" Arbor	1¼"-1½"	224.99	269.99	call
	1⅞"-1½"	239.99	344.99	call
	1⅜"-1¾"	259.99	384.99	call
	1⅞"-2"	279.99	409.99	call
Fits Storm Vulcan 15, 15 Special, 1550, 1648				
20"	¾"-1"	\$221.99	\$224.99	call
3" Arbor	1¼"-1½"	224.99	269.99	call
	1⅞"-1½"	279.99	344.99	call
	1⅜"-1¾"	279.99	409.99	call
	1⅞"-2"	309.99	409.99	call
Fits Kwik-Way / Lempco				
20"	¾"-1"	\$221.99	call	call
3¾" Arbor	1¼"-1½"	224.99	call	call
	1⅞"-1½"	279.99	call	call
	1⅜"-1¾"	309.99	call	call
	1⅞"-2"	344.99	call	call
Fits Kwik-Way / Lempco 539 & Storm Vulcan 15A (early)				
22"	¾"-1"	\$309.99	\$467.59	call
5" Arbor	1¼"-1½"	319.99	589.99	call
	1⅞"-1½"	344.99	659.99	call
	1⅜"-1¾"	364.99	679.99	call
	1⅞"-2"	384.99	689.99	call
Fits Peterson Berco 180				
22"	¾"-1"	\$309.99	\$467.59	\$484.99
8" Arbor	1¼"-1½"	329.99	609.99	684.99
	1⅞"-1½"	344.99	684.99	694.99
	1⅜"-1¾"	364.99	704.99	709.99
	1⅞"-2"	394.99	709.99	724.99
Fits Storm Vulcan 15A (late), 15A Special; RMC/Robbi REX-1200				
24"	¾"-1"	\$319.99	\$467.59	\$484.99
5" Arbor	1¼"-1½"	344.99	609.99	684.99
	1⅞"-1½"	414.99	684.99	694.99
	1⅜"-1¾"	454.99	704.99	709.99
	1⅞"-2"	499.99	709.99	724.99
Fits Kwik-Way / Lempco KGA and NKG Series				
24"	¾"-1"	\$319.99	\$467.59	\$484.99
5" Arbor	1¼"-1½"	344.99	609.99	684.99
	1⅞"-1½"	414.99	684.99	694.99
	1⅜"-1¾"	454.99	704.99	709.99
	1⅞"-2"	499.99	709.99	724.99
Van Norman 438, 448, 460, 465; Winona Van Norman/Zanrosso CG-210 (early); Storm Vulcan Scledum 200				
24"	¾"-1"	\$329.99	\$539.99	\$569.99
8" Arbor	1¼"-1½"	354.99	609.99	659.99
	1⅞"-1½"	414.99	684.99	669.99
	1⅜"-1¾"	454.99	704.99	689.99
	1⅞"-2"	499.99	709.99	699.99
Storm Vulcan 15C				
25"	¾"-1"	\$384.99	\$529.99	\$549.99
5" Arbor	1¼"-1½"	414.99	609.99	684.99
	1⅞"-1½"	444.99	684.99	694.99
	1⅜"-1¾"	479.99	704.99	709.99
	1⅞"-2"	499.99	709.99	724.99
AMC K1100; Peterson Berco 180, 225; Scledum 200, 230; Van Norman 438, 448, 460, 465, 475, 476; Winona Van Norman CG-210 (late), CG-840				
26"	¾"-1"	\$444.99	\$569.99	\$579.99
8" Arbor	1¼"-1½"	467.59	619.99	674.99
	1⅞"-1½"	499.99	724.99	799.99
	1⅜"-1¾"	499.99	774.99	809.99
	1⅞"-2"	559.99	784.99	829.99
	2⅞"-2¼"	call	799.99	879.99

Dia.	Face Width	WAA Jobber	GCH Jobber	GCD Jobber
Schou 1500/270, 1600, 260				
27½"	¾"-1"	call	\$569.99	\$619.99
8⅝" Arbor	1¼"-1½"	call	619.99	674.99
	1⅞"-1½"	call	724.99	829.99
	1⅜"-1¾"	call	774.99	809.99
	1⅞"-2"	call	call	879.99
	2⅞"-2¼"	call	call	914.99
Peterson Berco 260; SV Scledum 230, 270/280; Zanrosso Mito 250; Van Norman 400, 438, 454, 475, 476, 666; RMC/Robbi REX-1500				
28"	¾"-1"	\$499.99	\$569.99	\$619.99
8" Arbor	1¼"-1½"	539.99	619.99	674.99
	1⅞"-1½"	569.99	724.99	829.99
	1⅜"-1¾"	589.99	774.99	809.99
	1⅞"-2"	619.99	call	819.99
	2⅞"-2¼"	649.99	call	829.99
	2⅞"-2⅝"	call	call	1049.99
Seest MC62				
30"	¾"-1"	call	\$704.99	call
6" Arbor	1¼"-1½"	call	894.99	call
	1⅜"-1¾"	call	879.99	call
	1⅞"-2"	call	849.99	call
Zanrosso Mito 280; Storm Vulcan Scledum 270/280; RMC / Robbi REX-1800, REX 2200L				
30"	¾"-1"	\$574.99	\$724.99	\$849.99
8" Arbor	1¼"-1½"	574.99	774.99	914.99
	1⅞"-1½"	699.99	829.99	969.99
	1⅜"-1¾"	699.99	849.99	1039.99
	1⅞"-2"	849.99	859.99	1244.99
	2⅞"-2¼"	call	call	1174.99
	2⅞"-2⅝"	call	call	1194.99
AMC 1400, K1500, K1800; Van Norman 467, 477; Zanrosso				
32"	¾"-1"	\$574.99	\$829.99	\$859.99
8" Arbor	1¼"-1½"	574.99	879.99	899.99
	1⅞"-1½"	699.99	974.99	934.99
	1⅜"-1¾"	699.99	974.99	984.99
	1⅞"-2"	849.99	999.99	1119.99
	2⅞"-2¼"	call	call	1159.99
	2⅞"-2⅝"	call	call	1224.99
Peterson Berco 280, 300; RMC Robbi REX-1800RM; REX-2200, REX-2200RM, REX-2700RM, REX-3100RM				
32"	¾"-1"	\$689.99	\$829.99	\$859.99
12" Arbor	1¼"-1½"	799.99	879.99	899.99
	1⅞"-1½"	859.99	974.99	934.99
	1⅜"-1¾"	859.99	974.99	984.99
	1⅞"-2"	859.99	999.99	1119.99
	2⅞"-2¼"	call	call	1159.99
2⅞"-2⅝"	call	call	1224.99	
Peterson Berco 300, 350; Storm Vulcan Scledum 250; RMC / Robbi REX-2200M, 2700M, 3100M; Winona Van Norman 111				
36"	¾"-1"	\$899.99	call	\$1129.99
12" Arbor	1¼"-1½"	934.99	call	1129.99
	1⅞"-1½"	1009.99	call	1159.99
	1⅜"-1¾"	1069.99	call	1184.99
	1⅞"-2"	1199.99	call	1224.99
	2⅞"-2¼"	1224.99	call	1279.99
	2⅞"-2⅝"	call	call	1349.99

tech tips NOTE: All wheels are delivered up to .015" oversized to allow for side dressing when mounting the wheel



Mach-β
Grinding Wheel Shaping & Resizing
a division of Goodson Shop Supplies

Ask us about resizing or reshaping your existing wheel!

CYLINDER HEAD REBUILDING
CLEANING, ASSEMBLY & SAFETY
SHORT BLOCK REBUILDING
CRANKSHAFT / FL WHEEL GRINDING
MISCELLANEOUS TOOLS & SUPPLIES
BRAKE SERVICE TOOLING
MEASURING TOOLS
V-TWIN & METRIC HARD PARTS

Reluctor Ring Installation Jig

CYLINDER HEAD
REBUILDING

CLEANING,
ASSEMBLY & SAFETY

SHORT BLOCK
REBUILDING

CRANKSHAFT/
FLYWHEEL GRINDING

MISCELLANEOUS
TOOLS & SUPPLIES

BRAKE SERVICE
TOOLING

MEASURING
TOOLS

V-TWIN & METRIC
HARD PARTS



All steel construction features 2 indexing dowels to properly align the reluctor ring when installing it on the crankshaft. Designed to fit Generation III (LS1, LS6) and Generation IV (LS 2, LS3, LS7) engines. **US Patent No. 7,716,827.**

**Goodson
exclusive**

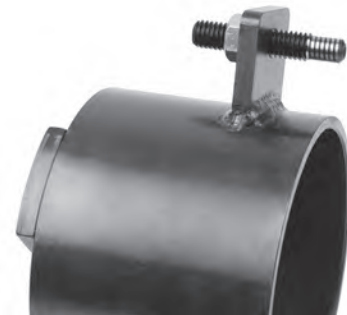

The 8mm indexing dowel is attached to the fixture by an exterior tang. It can be adjusted for depth to accommodate a variety of popular flange widths. This dowel fits into the only 8mm hole on the reluctor wheel.



The internal indexing dowel pin is designed to fit into the dowel pin hole on the crankshaft. It is adjustable to fit different depths. The combination of dowel pins gives very precise alignment of the reluctor wheel and crankshaft.

Description	Jobber	Order No.
Reluctor Ring Installation Tool	\$219.99	RRJ-350
Temperature Indicating Crayon (450° F/232°C)	19.49	TIC-450

tech tips

from the techxperts™

Heat reluctor ring to 450°F (232°C) then slide it onto the casting. Be sure to deburr all components before beginning assembly. Any sharp edges will cause the reluctor ring to catch on the casting, making assembly impossible.

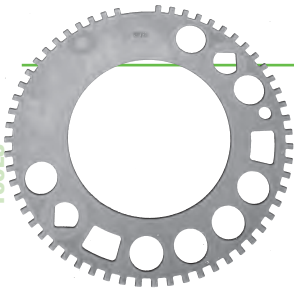

GM Steel 58 Tooth Reluctor Ring

- Single Piece Steel
- Fits LS2, LS3 & LS7
- Order No. **RR-58T**
- Jobber \$23.99



Callies 24 Tooth Billet Steel Reluctor Ring

- For LS1 & LS6 Engines
- Single Piece
- Order No. **RR-24T**
- Jobber \$112.99



Dampener Installer

- Install harmonic dampeners without thrust bearing damage
- Screw tool into hole in the crankshaft end
- Use the nut and thrust bearing to draw the harmonic dampener onto the crankshaft snout
- Fits 7/8" x 20" and 1/2" x 20" holes • 3 piece set
- Order No. **DIT-2**
- Jobber \$69.99



Eliptibur Tool

- Fastest, safest way to chamfer crank oil holes
- Simplify deburring and chamfering of angularly drilled holes on cylindrical surfaces
- Easily produces a chamfer of relative uniformity and depth
- Self-centering, spring loaded pilot
- Includes one replaceable blade
- For 30Rc or softer crankshafts

Description	Jobber	Order No.
Eliptibur Tool (1 blade included)	\$259.99	EBT-15
Replacement Blade	41.99	EBT-15B
Replacement Pilot	68.99	EBT-15N



Create a relief in the block for rod #2 at the pan rail area using your normal process.



Place the arbor in main saddles 1 & 2, keeping the flange nearest to the pointer against #2.



Rotate the arbor and adjust the pointer until the tapered end passes freely through the relief with a minimum of clearance.



Lock the pointer in position with the set screw and check the clearance.



Once satisfied, scribe a line on the pointer opposite the set screw.

Must use when building a Stroker Engine!

Stroker Mimic™

- Lightweight and easy to use
- Eliminates the need to repeatedly install and remove the crankshaft, pistons, the rod assembly and the necessary bearings when clearancing a block for a stroker crank
- Once the Stroker Mimic™ has been set to a particular crank, rod and piston combination, the tool can be marked or measured for future reference



Description	Jobber	Order No.
Stroker Mimic™ Fixture for 350 Blocks	\$167.99	SM-350
Replacement Pointer for SM-350	33.99	SM-351



Cam & Crank Grinding Coolant

- Semi synthetic
- Non-nitrite
- High-lubricity
- Dilute 20 parts water to 1 part coolant

Size	Jobber	Order No.
1 gallon (3.78L)	\$ 33.99	CGC-10
5 gallons (18.93L)	149.99	CGC-50

Hand-Held Dressing Sticks

- Keep your crankshaft grinding wheels cutting clean



Hard Silicon-Carbide

- 1" x 1" x 6"
- Use to deglaze wheel side
- Removes material with light pressure
- Order No. **GG-112** Jobber \$19.99

Dense Granular Norbide

- 3/16" x 1/2" x 3"
- For fine tuning radius and side relieving wheels
- Order No. **DS-NOR** Jobber \$64.99

Plastigage

- Accurately measure bearing clearance
- Color coded by size
- Put a piece on rod or main bearing and torque the cap
- Remove and inspect – width of crushed Plastigage shows clearance
- Use at the workbench or in the vehicle
- 10 per pack

Clearance Range	Jobber	Order No.
.001" to .003" (.025 to .076mm)	\$21.99	PG-GREEN
.002" to .006" (.051 to .152mm)	21.99	PG-RED
.004" to .009" (.102 to .229mm)	21.99	PG-BLUE
10pk. Assortment : 5 Green, 3 Red, 2 Blue	21.99	PG-10PK



Crankshaft Journal Radius Gauge

- 16 radii ... 1/32" to 17/64"
- Measure radii of reground journals quickly
- Blades are clearly marked in 1/64" increments
- Use in holder or remove to use blades separately
- Order No. **RG-16** Jobber \$44.99

Hardness Tester

- Calculate Rockwell Hardness quickly and accurately
- Range: 15 to 65 Rockwell on C-Scale
- Features a steel ball of precise weight and shape which is dropped from an exact height to yield an accurate Rc reading
- Check overheated or repaired crankshaft journals to confirm correct hardness
- Also use on flywheels
- Weighs just 4 oz. • 9 1/4" long
- Includes case & instructions
- Order No. **HT-45RC** Jobber \$229.99



Crankshaft Straightening Peening Tool

- Designed for narrow journals on some new-style V6 crankshafts
- Peen crankshafts in the radius area of damaged journals to straighten
- Long-shank
- Offset-radius face
- 10" long • 0.0625" radius
- 0.125" diameter

Description	Jobber	Order No.
Peening Tool	\$45.99	CPT-062
Safety Glasses	5.99	PGL-21

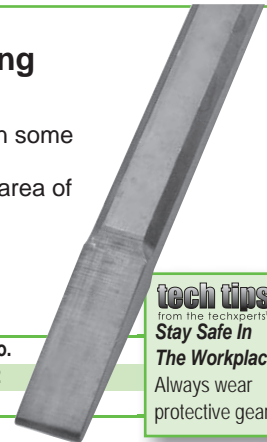

tech tips
from the techxperts™
**Stay Safe In
The Workplace!**
Always wear protective gear.

Stroke Checker

- Accurately measure strokes up to 6"
- Works with any precision caliper to accurately measure crankshaft strokes
- Measures strokes up to 6" with an accuracy of .001"
- Rigid, hard-anodized aluminum frame is fully adjustable
- Fits almost any crankshaft
- Order No. **CSG-1** Jobber \$183.99

See page 121 for our selection of calipers

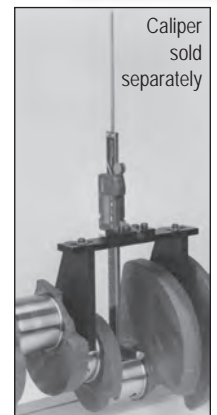

Universal Quick-Set Crankshaft Grinder Dial Indicator

- 3/8" diameter shaft • 12" long.
- .125" travel, .050" per revolution
- Rotating, lockable bezel graduated in .001" from -.025" to +.025"
- Order No. **MDI-12** Jobber \$399.99



More Dial Indicators on page 121

Starrett

CYLINDER HEAD REBUILDING
CLEANING, ASSEMBLY & SAFETY
SHORT BLOCK REBUILDING
CRANKSHAFT/FLYWHEEL GRINDING
MISCELLANEOUS TOOLS & SUPPLIES
BRAKE SERVICE TOOLING
MEASURING TOOLS
V-TWIN & METRIC HARD PARTS



"If you're not sure what to order or if you have any questions, give us a call! We're here from 8am to 5pm Central time, weekdays to serve you. We can help you get the most from our products and your equipment."

- Chris, Goodson ASE-Certified Master Machinist, 33 years of service

CYLINDER HEAD REBUILDING
CLEANING, ASSEMBLY & SAFETY
SHORT BLOCK REBUILDING
CRANKSHAFT/ FLYWHEEL GRINDING
MISCELLANEOUS TOOLS & SUPPLIES
BRAKE SERVICE TOOLING
MEASURING TOOLS
V-TWIN & METRIC HARD PARTS

SAVE 10% off jobber!
Order 5 or more boxes of crank polishing belts (any combination)



Premium Ruby Aluminum-Oxide Crankshaft Polishing Belts

- Specifically for use on metal
- Closed coat J-weight cloth backing with a high strength mylar joint
- Phenolic resin-over-resin bond
- Ruby Aluminum-Oxide abrasive
- Polish better and outlast other standard polishing belts
- Color may vary due to manufacturing process

Custom Belts Now Available

STRAIGHT-EDGE (10 per box)

L	W	Jobber	320 grit	400 grit	600 grit
60"	3/4"	29.99	R60x3/4x320	R60x3/4x400	R60x3/4x600
	1"	32.99	R60x1x320	R60x1x400	R60x1x600
	1 1/4"	34.99	R60x1 1/4x320	R60x1 1/4x400	R60x1 1/4x600
	1 1/2"	36.99	R60x1 1/2x320	R60x1 1/2x400	R60x1 1/2x600
	1 3/4"	39.99	R60x1 3/4x320	R60x1 3/4x400	R60x1 3/4x600
	2"	41.99	R60x2x320	R60x2x400	R60x2x600
64"	3/4"	31.99	R64x3/4x320	R64x3/4x400	R64x3/4x600
	1"	33.99	R64x1x320	R64x1x400	R64x1x600
	1 1/4"	35.99	R64x1 1/4x320	R64x1 1/4x400	R64x1 1/4x600
	1 1/2"	37.99	R64x1 1/2x320	R64x1 1/2x400	R64x1 1/2x600
	1 3/4"	40.99	R64x1 3/4x320	R64x1 3/4x400	R64x1 3/4x600
	2"	42.99	R64x2x320	R64x2x400	R64x2x600
72"	3/4"	31.99	R72x3/4x320	R72x3/4x400	R72x3/4x600
	1"	34.99	R72x1x320	R72x1x400	R72x1x600
	1 1/4"	36.99	R72x1 1/4x320	R72x1 1/4x400	R72x1 1/4x600
	1 1/2"	39.99	R72x1 1/2x320	R72x1 1/2x400	R72x1 1/2x600
	1 3/4"	42.99	R72x1 3/4x320	R72x1 3/4x400	R72x1 3/4x600
	2"	45.99	R72x2x320	R72x2x400	R72x2x600
77"	3/4"	33.99	R77x3/4x320	R77x3/4x400	R77x3/4x600
	1"	36.99	R77x1x320	R77x1x400	R77x1x600
	1 1/4"	38.99	R77x1 1/4x320	R77x1 1/4x400	R77x1 1/4x600
	1 1/2"	41.99	R77x1 1/2x320	R77x1 1/2x400	R77x1 1/2x600
	1 3/4"	44.99	R77x1 3/4x320	R77x1 3/4x400	R77x1 3/4x600
	2"	47.99	R77x2x320	R77x2x400	R77x2x600

All abrasives are guaranteed for 1 year from the original purchase date

Micro Finish Scotch-Brite Style Abrasive Rolls

- Ideal for hand polishing of high-performance crankshafts
- Non-directional polish
- Won't remove material
- Aluminum oxide abrasive with a high-strength resin bond
- Measures: 3/4"x10'
- 1 Per Box
- Order No. **GFR-750**
Jobber \$29.99



Premium Ceramic Micro Polishing Belts

- Polishing rouge is recommended to achieve the highest luster finish
- Structured Abrasive
- 5 per box



Size (LxW)	Jobber	Order No.
60" x 1"	\$39.99	GS-60x1
64" x 1"	39.99	GSW-64x1
72" x 1"	41.79	GS-72x1
77" x 1"	53.99	GSW-77x1
Polishing Rouge	12.99	CPR-16



Crankshaft Polishing Belt Sample Pack

Want to try some different polishing belts but don't want to buy a large quantity? Here's your chance! These sample packs include 5 of our most popular belts. Contents may vary.

Belt Length x Width	Jobber	Order No.
64" x 1"	\$21.99	PCP-64PAK
72" x 1"	21.99	PCP-72PAK

Heavy Duty Steel Stamps

- For hard materials
- Order in sets

Number Sets

Figure	Shank	Jobber	Order No.
1/8"	5/16"	\$46.99	SFH-1/8
3/16"	3/8"	51.99	SFH-3/16

Special and custom orders are available, call 1-800-533-8010



Crankshaft Grinder Steady Rest Shoes for Peterson-Berco

- 5/16" thick
- Use same shoe for upper and lower replacement
- Order No. **RBE-200**
Jobber \$25.99



Crank Welding Plug Rods

- 3 diameters available
- Each rod is 12 1/2" long and cuts off easily
- Sharpen ends with your existing pencil sharpener
- 5 Crank Welding Plug Rods per pack

Size	Jobber	Order No.
.250"	\$15.79	CWPR-250
.312"	15.79	CWPR-312
.375"	15.79	CWPR-375

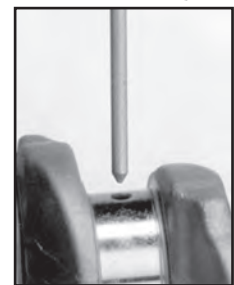
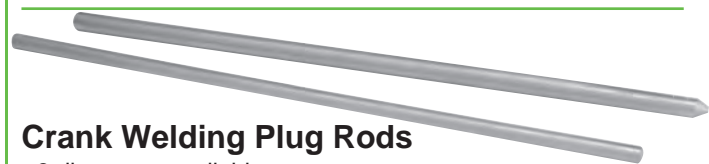

Crankshaft Polishing Belts

10 Belts
Per Box

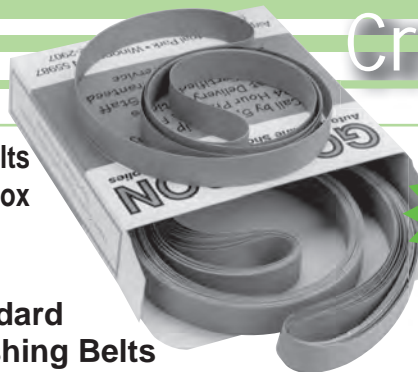

Now With
Even More
Selection!

Standard Polishing Belts

- US CAMI Grade aluminum-oxide abrasive
- 2-layer glue bond • Fast break-in
- Use with Polishing Rouge (CPR-16) for better finish
- Highly flexible J-Weight cloth backing
- Less aggressive belts for polishing

STANDARD STRAIGHT-EDGE (10 per box)					
Lgth	Width	Jobber	240 grit	320 grit	400 grit
60"	3/4"	\$31.99	60x3/4x240	60x3/4x320	60x3/4x400
	1"	33.99	60x1x240	60x1x320	60x1x400
	1 1/4"	35.99	60x1 1/4x240	60x1 1/4x320	60x1 1/4x400
	1 1/2"	37.99	60x1 1/2x240	60x1 1/2x320	60x1 1/2x400
	1 3/4"	39.99	60x1 3/4x240	60x1 3/4x320	60x1 3/4x400
64"	2"	42.99	60x2x240	60x2x320	60x2x400
	3/4"	32.99	64x3/4x240	64x3/4x320	64x3/4x400
	1"	34.99	64x1x240	64x1x320	64x1x400
	1 1/4"	36.99	64x1 1/4x240	64x1 1/4x320	64x1 1/4x400
	1 1/2"	38.99	64x1 1/2x240	64x1 1/2x320	64x1 1/2x400
70"	1 3/4"	40.99	64x1 3/4x240	64x1 3/4x320	64x1 3/4x400
	2"	42.99	64x2x240	64x2x320	64x2x400
	3/4"	33.99	70x3/4x240	70x3/4x320	70x3/4x400
	1"	35.99	70x1x240	70x1x320	70x1x400
	1 1/4"	37.99	70x1 1/4x240	70x1 1/4x320	70x1 1/4x400
72"	1 1/2"	39.99	70x1 1/2x240	70x1 1/2x320	70x1 1/2x400
	1 3/4"	41.99	70x1 3/4x240	70x1 3/4x320	70x1 3/4x400
	2"	43.99	70x2x240	70x2x320	70x2x400
	3/4"	34.99	72x3/4x240	72x3/4x320	72x3/4x400
	1"	36.99	72x1x240	72x1x320	72x1x400
77"	1 1/4"	38.99	72x1 1/4x240	72x1 1/4x320	72x1 1/4x400
	1 1/2"	40.99	72x1 1/2x240	72x1 1/2x320	72x1 1/2x400
	1 3/4"	42.99	72x1 3/4x240	72x1 3/4x320	72x1 3/4x400
	2"	44.99	72x2x240	72x2x320	72x2x400
	3/4"	36.99	77x3/4x240	77x3/4x320	77x3/4x400
77"	1"	38.99	77x1x240	77x1x320	77x1x400
	1 1/4"	40.99	77x1 1/4x240	77x1 1/4x320	77x1 1/4x400
	1 1/2"	42.99	77x1 1/2x240	77x1 1/2x320	77x1 1/2x400
	1 3/4"	44.99	77x1 3/4x240	77x1 3/4x320	77x1 3/4x400
	2"	46.99	77x2x240	77x2x320	77x2x400

All abrasives are guaranteed for 1 year from the original purchase date

SAVE 10% off jobber!

Order 5 or more boxes of crank polishing belts (any combination)



Standard Scalloped Edge Crankshaft Polishing Belts

- 10 per box • 320 grit • 1" wide
- Ideal for radius polishing
- Double layer urea glue bond CAMI grade polishing belts

Length	Jobber	Order No.
64"	\$36.99	S64x1x320
72"	38.99	S72x1x320



Fine Finish

- Aluminum-oxide • Flexible, woven back
- Phenolic Resin-Over-Resin bond
- Very aggressive • Sharper grains cut faster without sacrificing finish • The "Blue Backed Belt" • Use with Grind Aid (GRA-10) or Polishing Rouge (CPR-16)



Fine Finish (10 per box)

Length	Width	Jobber	320 grit	Jobber	400 grit
60"	1"	\$41.99	G-60x1x320	\$41.99	G-60x1x400
64"	1"	41.99	G-64x1x320	43.99	G-64x1x400
72"	1"	49.99	G-72x1x320	45.99	G-72x1x400
77"	1"	49.99	G-77x1x320	49.99	G-77x1x400

Need a Different Width or Length? Give Goodson a Call - We Make 'Em Here!

Scotch-Brite Style Micro Finish

- Rigid, 3-dimensional back • Resin bond • Aluminum-oxide abrasive • Non-directional Satin finish
- Use with Grind Aid (GRA-10)

Micro-Finish (1 per box)

Length	Width	Jobber	Order No.
60"	3/4"	\$29.99	GFB-60 x 3/4
	1"	29.99	GFB-60 x 1
64"	3/4"	29.99	GFB-64 x 3/4
	1"	29.99	GFB-64 x 1
70"	3/4"	29.99	GFB-70 x 3/4
	1"	29.99	GFB-70 x 1
72"	3/4"	29.99	GFB-72 x 3/4
	1"	29.99	GFB-72 x 1
77"	3/4"	29.99	GFB-77 x 3/4
	1"	29.99	GFB-77 x 1

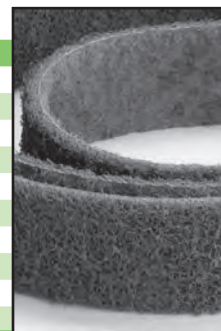

Scotch-Brite Style Super-Micro Finish

- Produces a mirror-like non-directional finish
- Resin bond • Silicon-Carbide abrasive
- For final Satin finish • Use with Grind Aid (GRA-10)

Super-Micro Finish (1 per box)

Length	Width	Jobber	Order No.
60"	3/4"	\$27.99	SGFB-60 x 3/4
	1"	29.99	SGFB-60 x 1
64"	3/4"	29.99	SGFB-64 x 3/4
	1"	30.99	SGFB-64 x 1
70"	3/4"	30.99	SGFB-70 x 3/4
	1"	31.99	SGFB-70 x 1
72"	3/4"	31.99	SGFB-72 x 3/4
	1"	32.99	SGFB-72 x 1
77"	3/4"	32.99	SGFB-77 x 3/4
	1"	33.99	SGFB-77 x 1

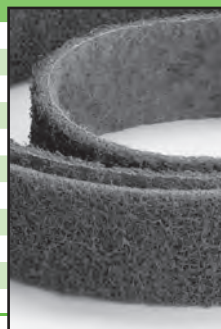

Abrasive Cork Super-Fine Finish

- Won't disturb polished radii
- Silicon-carbide • Use with Polishing Rouge (CPR-16) for High Luster finish

Abrasive Cork (1 per box)

Length	Width	Jobber	Order No.
64"	3/4"	\$14.99	CPB-64-3/4
	1"	14.99	CPB-64-1
70"	3/4"	14.99	CPB-70-3/4
	1"	14.99	CPB-70-1
72"	3/4"	14.99	CPB-72-3/4
	1"	14.99	CPB-72-1
77"	3/4"	14.99	CPB-77-3/4
	1"	14.99	CPB-77-1



Need A Size You Don't See? Give Us A Call; We Make 'Em Here!

CYLINDER HEAD REBUILDING
CLEANING, ASSEMBLY & SAFETY
SHORT BLOCK REBUILDING
CRANKSHAFT/FLYWHEEL GRINDING
MISCELLANEOUS TOOLS & SUPPLIES
BRAKE SERVICE TOOLING
MEASURING TOOLS
V-TWIN & METRIC HARD PARTS



"We believe every customer is important. If you need one of our tools or supplies overnight or have a last minute change n your order, you can count on Goodson. You'll always receive the kind of courteous, personal attention that shows how much we appreciate your business."

- Hannah, Goodson Sales & Service, 2 years of service

CYLINDER HEAD
REBUILDING

CLEANING,
ASSEMBLY & SAFETY

SHORT BLOCK
REBUILDING

CRANKSHAFT/
FLYWHEEL GRINDING

MISCELLANEOUS
TOOLS & SUPPLIES

TOOLING

MEASURING
TOOLS

V-TWIN & METRIC
HARD PARTS

Crankshaft Polishing Starter Kit

Includes 1 each of:

- Grind Aid,
- Polishing Rouge,
- Abrasive Dresser and
- 5-Pack of our most popular 72" belts
- Order No. **CP-KIT** Jobber \$57.99



Grind Aid

- Cools and lubricates
- Reduces loading-up and grain fracturing
- Belts produce a better finish and last up to twice as long
- Use only on cloth-back belts such as those shown on pages 98 & 99
- Order No. **GRA-10** Jobber \$17.99



Polishing Rouge

- Produces high luster finish
- Use with light pressure, for cork or fine grit polishing to finish crank journals perfectly
- Hard, dry compound becomes viscous with heat • White • 16 oz. / 454 g
- Order No. **CPR-16** Jobber \$12.99



Abrasive Dresser

- Prolongs belt life
- Hold at 45° angle on moving belt to remove foreign material
- Restores cutting ability of grains
- 2" x 2" x 4" / 51 x 51 x 102mm
- Order No. **ACB-224** Jobber \$17.99

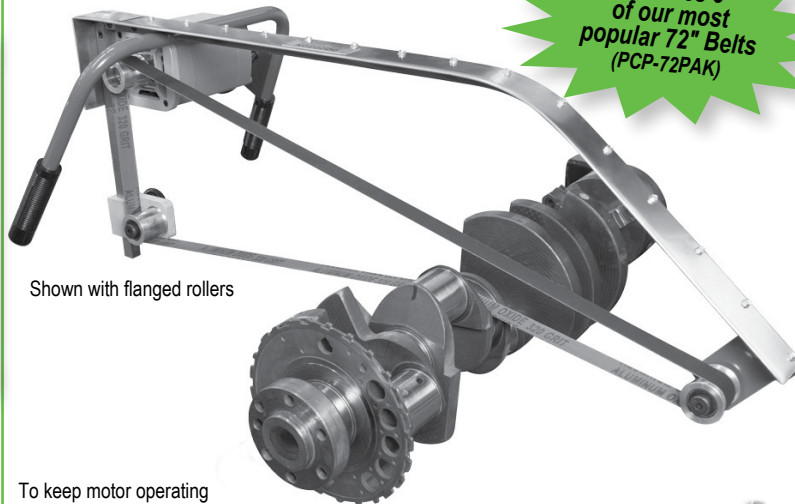
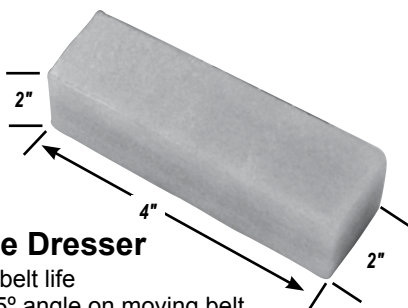

Shown with flanged rollers

Includes 5 of our most popular 72" Belts (PCP-72PAK)

To keep motor operating efficiently, clean with compressed air regularly.

American Made

tech tips
from the techxperts™ *Extend the life of your polishing belts by releasing the tension when not in use.*

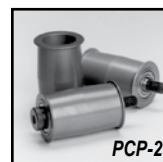

72" Crankshaft Polisher

- Flex resistant steel frame
- Weighs 15 lbs. (6.8 kg)
- Crowned rollers keep snug belt running true
- 1" nominal = 1.625"
- 2" nominal = 2.625"
- 1/2 HP motor designed for high RPM not heavy loads
- Specify flanged or unflanged rollers when ordering

Roller Width						
Nominal	Actual	HP	Max. RPM	Jobber	Order No.	
1"/25mm	1.625"/41mm	1/2	10,000	\$ 1039.99	PCP-1072	
2"/51mm	2.625"/67mm	1/2	10,000	1069.99	PCP-1072-2	
Replacement Parts and Rollers						Includes
Flanged Roller Sets		1"		\$149.99	PCP-1	▼
(3 piece set)		2"		179.99	PCP-2	▼
Unflanged Roller Sets		1"		159.99	PCP-1S	▼
(3 piece set)		2"		194.99	PCP-2S	▼
Flanged Drive Roller		1"		54.99	PCP-1D	1
Fits 3/8" shaft - 1 ea.		2"		59.99	PCP-2D	1
Flanged Roller Assembly		1"		59.99	PCP-1F	2
3/8" x 16 thread - 1 ea.		2"		79.99	PCP-2F	2
Unflanged Roller Assembly		1"		69.99	PCP-1-1EA	2
3/8" x 16 thread - 1 ea.		2"		74.99	PCP-2-EA	2
Bearing - 1 ea.				14.99	PCP-BRG	
Replacement Switch				25.99	PCP-SWITCH-72	
Replacement 110V, 60Hz Motor (square housing)				599.99	PCP-MOTOR-72S	
Replacement Motor Brush Set (also fits 220V)				34.99	PCP-BRUSH-72S	
Retrofit Motor Adaptor (round to square housing)				69.99	PCP-RFK	
Replacement Motor Brush Set (round housing)				34.99	PCP-BRUSH-72	

Crankshaft & Flywheel Tools

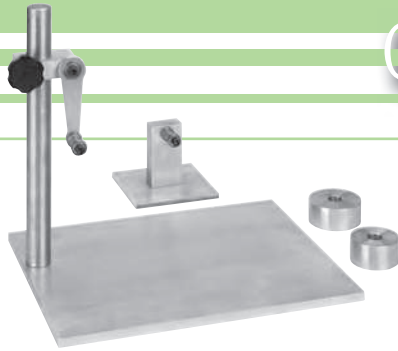

Rod Balancing Stand

- Ideal for static balancing parts
- Also use to weigh rotating and reciprocating masses and record the information for dynamic balancing
- Heavy-duty steel construction
- Includes 1-2" (50.8mm) and 1-2.3" (58.4mm) support discs
- Height adjustment accommodates different rod sizes
- Order No. **BS-201** Jobber \$257.99



Heavy Metal

An essential component when balancing rods & pistons to crankshafts to ensure proper engine operation. Contains 90% Tungsten



HEAVY METAL – TUNGSTEN 90%

Hole in	Press Fit + in/mm	1.0" Long			1.2" Long		
		Grams	Jobber	Order No.	Grams	Jobber	Order No.
1/2"	.002"/.05	57	\$21.99	HM-57	65	\$29.99	HM-72
3/4"	.002"/.05	122	25.99	HM-122	147	30.99	HM-162
7/8"	.002"/.05	169	33.99	HM-169	198	41.99	HM-198
1"	.002"/.05	227	49.99	HM-227	265	56.99	HM-265

NOTE: Due to market fluctuations, heavy metal prices are subject to change without notice. Please confirm pricing when ordering.

Pin Pal Puller

- Remove dowels fast
- Adjusts to pull all sizes of dowels
- Locking pliers with special hardened jaws hold firm while 4 lb. slide hammer forces dowels out
- Also pulls pressed-in hollow tubes or frozen shafts
- Rugged steel construction



Description	Jobber	Order No.
Complete Tool	\$314.99	GA-300
Replacement Jaws	82.99	GA-300E-R

Mirrored Safety Glasses

- Wrap-around design
- Tinted lenses provide sun glare protection
- Universal bridge
- Polycarbonate lenses
- Do not use as welders helpers
- Order No. **PGL-21** Jobber \$5.99



6100 Gram Balancing Scales

- Scales feature automatic tare weight correction
- 1.0 Gram / 0.100 Ounce increments
- Operates on 9V battery (not included) or 110V converter (included) • Low battery indicator
- Order No. **BS-6100** Jobber \$599.99

tech tips

from the techxperts™

It is essential, when pulling a dowel, that the tightening sleeve is installed with the flared end toward the collet. This will allow the tightening sleeve to slide over the collet, locking it to the dowel you are removing. Also, be sure to select the correct collet size for the dowel you are removing.



Dowel Puller and Collets

- Slide hammer action removes stubborn dowels
- Use on blocks, heads, flywheels, etc.
- Split collets grip firmly without causing damage
- A high-quality tool that lets you reuse dowel pins
- Choose from SAE or Metric kits
- All items also sold separately

Description	Jobber	Order No.	Incl.
Standard Kit	\$189.99	GA-600	▼
Metric Kit	189.99	GA-600M	▼
Slide Shaft	14.99	GAO-1	x x
Slide Hammer	22.99	GAO-2	x x
Tightening Sleeve	36.99	GAO-3	x x
Gripping Collets			
OD	ID	mm	
1"	.1575"	4.00	\$34.99 GAO-22 x
1"	.1875"	4.76	34.99 GAO-4
1"	.1969"	5.00	34.99 GAO-13 x
1"	.2362"	6.00	34.99 GAO-14 x
1"	.2500"	6.35	34.99 GAO-5 x
1"	.2756"	7.00	34.99 GAO-26
1"	.3125"	7.94	34.99 GAO-6 x
1"	.3150"	8.00	34.99 GAO-10 x
1"	.3750"	9.53	34.99 GAO-7 x
1"	.3937"	10.00	34.99 GAO-23
1"	.4375"	11.11	34.99 GAO-8 x
1"	.4724"	12.00	34.99 GAO-24
1"	.5000"	12.70	34.99 GAO-9
1"	.6250"	15.88	34.99 GAO-20
Removal Basin	24.99	GAO-21	x x

Parts are stamped for easy identification & reordering

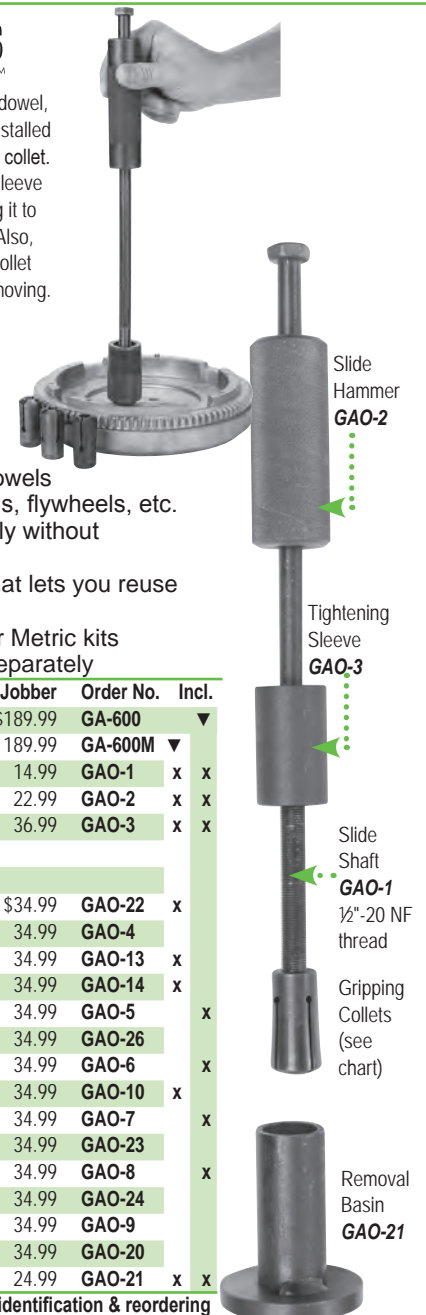

CYLINDER HEAD REBUILDING
CLEANING, ASSEMBLY & SAFETY
SHORT BLOCK REBUILDING
CRANKSHAFT/ FLYWHEEL, GRINDING
MISCELLANEOUS TOOLS & SUPPLIES
BRAKE SERVICE TOOLING
MEASURING TOOLS
V-TWIN & METRIC HARD PARTS

... another satisfied customer



"Goodson was able to help me select the right grinding stones for our racing clutch and flywheel program. Their support and technical advice is always available to keep our program on the right track."

- Johnny Ahten, Johnny Ahten Racing - Goodson customers since 2005

CYLINDER HEAD
REBUILDING

CLEANING,
ASSEMBLY & SAFETY

Flywheel Radius Cutter Tip Holder

- For Winona Van Norman/ Van Norman FG-5000
- Holder measures 1.5"L with a .312" dia. shank
- Includes 1 indexable FG-3B cutter tip

Description	Jobber	Order No.
Tip Holder	\$123.99	FG-5011
Replacement Tip	10.99	FG-3B

FG-3B

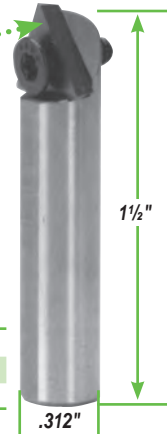

SHORT BLOCK
REBUILDING



Order 5 or more, take 10% off jobber!

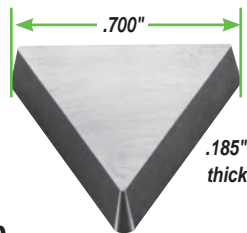

Flywheel Cutter Tip For Winona Van Norman 570 Rotary Broach

- 3-edge carbide cutting tip for use with the special flywheel attachment
- Order **VN-FW** Jobber \$16.99

CRANKSHAFT/
FLYWHEEL GRINDING

Flywheel Grinding Coolant

- Formula eliminates rancid coolant
- Synthetic inhibitors
- Dilute 30:1 (water:coolant)

Size	Jobber	Order No.
1 Gal. / 3.78L	\$ 41.99	FG-1101-G
5 Gal. / 18.8L	149.99	FG-1102-G



MISCELLANEOUS
TOOLS & SUPPLIES

Flywheel Grinder Bolt Adaptors

- Replace shoulder bolts with standard hardware
- Low-cost adaptor converts any 1/2" or 7/16" bolt to a 3/4" ID
- Includes countersunk adaptor with bolts for extra clearance



FG-LOCK

Fits	Size	Jobber	Order No.
DCM, Peterson, KW	1/2" x 13	\$33.99	FG-DCP-KIT
WVN	7/16" x 14	33.99	FG-AB-KIT
WVN Table Insert	OD: 5/8" x 11, ID: 7/16" x 14	6.99	FG-LOCK

BRAKE SERVICE
TOOLING

Flywheel Depth Gauge with Dial Indicator

- Measure flywheel before and after grinding to maintain proper depth specifications
- Gauge Assembly includes Dial Indicator, Bar & Magnets
- Spindle Extensions sold separately

Description	Jobber	Order No.
Gauge Assembly	\$129.99	FGG-12
Spindle 1.5"	11.99	DIS-1.5
Extensions 2.5"	11.99	DIS-2.5
3.0"	17.49	DIS-3.0

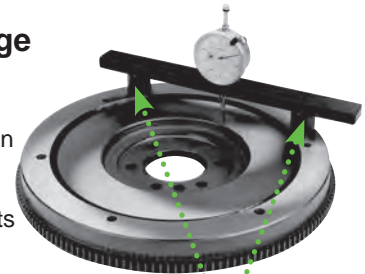

Magnetic feet adjust to flywheel diameter

MEASURING
TOOLS

V-TWIN & METRIC
HARD PARTS

Goodson Techxperts™ on staff to help you



When you have questions about product applications, tooling interchangeability, machining procedures, extending tool life, engine specs or any other technical topic, give the Goodson Tech Services Department a call at 1-800-533-8010.

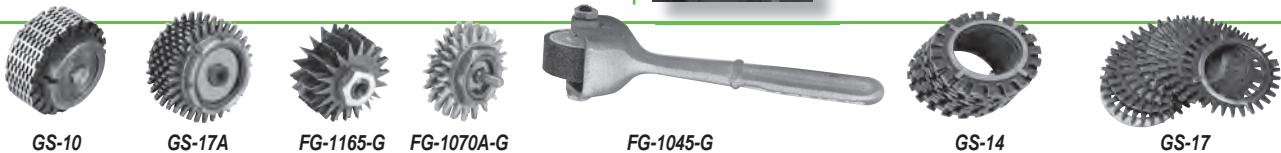

Grinding Wheel Dressers & Replacement Cutters

Diamond Dresser Tools are available on pages 106-107

Applications	Cutter Assemblies				Replacement Cutters						
	OD	W	Jobber	Order No.	Pieces	Washers	OD	ID	Thick	Jobber	Order No.
VN, Lempco, Storm RT-7Y, 17Y	2.500"	1.625"	\$116.99	GS-10	14 stars	1 w/locking tangs	2.50"	1.50"	.062"	\$23.99	GS-14
Peterson (12mm shaft)	2.375"	1.625"	93.79	GS-17A	8 stars	5	2.375"	1.50"	.093"		
						1 w/locking tangs	1.75"	1.50"	.060"	23.99	GS-17
WVN SM2000, 4000, 5000, 6000C, 6000A, MG3000, 3850	1.250"	.978"	29.99	FG-1165-G	7 stars	none	1.25"	.313"	.095"	7.99	FG-1161-G
Peterson & DCM	2.375"	2.262"	72.99	FG-1070A-G	5 stars		2.375"	1.132"	.1375"	16.99	FG-1070-G
Hand held			51.99	FG-1045-G	1 stone	none	1.50"	.313"	.625"	13.99	FG-1044-G

Flywheel Grinding Stones

tech tips

from the techxperts™

How to Measure A Flywheel Stone

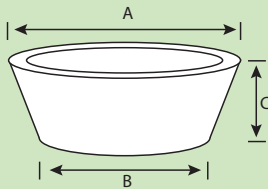

10% off jobber!
Order 5 or more flywheel grinding stones (any combination)



tech tips

from the techxperts™

Be sure to use ample coolant to flush away swarf and help the stones perform better.

For Best Results... Choose The Right Flywheel Stone From Goodson

Goodson stones feature 50% more usable abrasive and much stronger construction, yet sell at prices comparable to ordinary stones. With Goodson stones you'll get longer wheel life and lower-cost flywheel grinding.

Cast Iron:

Cast Iron (soft) flywheels need to be ground with harder stones. Experiment to find the best stone. A starting point is the FGW-57, our best all-around stone for Cast Iron.

Cast Steel:

Cast Steel (medium) flywheels require medium-hard stones. The FGW-65 is our best all-around stone for Cast Steel.

Billet Steel:

Billet Steel (very hard) flywheels need to be ground with softer stones. Our best all-around stone for Billet Steel is the FGW-50-2. It's our most friable and free-cutting, requiring minimal dressing.



More Flywheel Stones on page 104

Silicon-Carbide Abrasive

CAST IRON (Passenger cars, light trucks)

(A / B x C x Arbor)	Description	Jobber	Order No.
6" / 4½" x 2⅝" x 1¼"	Harder than FGW-57, lasts longer, black	\$51.99	FGW-67
6" / 4½" x 2⅝" x 1¼"	Best all-around for cast iron, black	51.99	FGW-57
6" x 2½" x 1¼"	Straight-sided FGW-57, black	50.99	FGW-57S
6" / 4½" x 2⅝" x 1¼"	Softer than FGW-57, grinds faster, black	47.99	FGW-47
6" / 4¾" x 2⅞" x 1¼"	Silicon-carbide, ideal for top fuel, black	47.99	FGW-37
4" / 3" x 2" x 1¼"	Small diameter FGW-57, black	59.99	FGW-61
4" / 3" x 2" x 1¼"	Small diameter FGW-37, black	29.99	FGW-374
3" x 2" x 1¼"	Green Silicon-Carbide, Premium	29.99	FGW-93

Silicon-Carbide/Aluminum-Oxide Combination

CAST STEEL (Industrial, agricultural, OTR trucks)

(A / B x C x Arbor)	Description	Jobber	Order No.
6" / 4½" x 2" x 1¼"	Harder than FGW-65 lasts longer, lt. gray	\$61.99	FGW-53
6" / 4½" x 2⅝" x 1¼"	Best all-around for Cast Steel, speckled	94.99	FGW-65
6" / 4½" x 2⅝" x 1¼"	Slightly softer than FGW-65, black	49.99	FGW-495
4" / 3" x 2" x 1¼"	Small diameter FGW-65, speckled	47.99	FGW-69
6" / 4½" x 2⅝" x 1¼"	Softer than FGW-65, grinds faster, black	79.99	FGW-49

Aluminum-Oxide Abrasive

BILLET STEEL (Import vehicles, high-performance)

(A / B x C x Arbor)	Description	Jobber	Order No.
6" / 4½" x 2⅝" x 1¼"	Harder, ruby stone, lasts longer	\$84.99	FGW-64
6" / 4½" x 2⅝" x 1¼"	Harder, pink stone, lasts longer	94.99	FGW-62-1
6" / 4½" x 2½" x 1¼"	Harder than FGW-50-2	67.99	FGW-50
6" / 4½" x 2½" x 1¼"	Best all-around for Billet Steel	77.99	FGW-50-2
4" / 3½" x 1½" x 1¼"	Harder, pink stone, lasts longer	44.99	FGW-63-1
4" / 3" x 2" x 1¼"	Taller than FGW-56, more abrasive, white	48.99	FGW-306
4" / 3½" x 1½" x 1¼"	Premium	36.99	FGW-56P
4" / 3½" x 1½" x 1¼"	Small diameter, off white	29.99	FGW-56
3" / 2¼" x 1¼" x ¾"	Small diameter, light gray	28.99	FGW-59
3" x 2" x 1¼"	Sugar white stone	25.99	FGW-92

NOTE: Due to manufacturing process, colors may vary.

All abrasives are guaranteed for 1 year from original purchase date.

Mounting Adaptor

For Small Diameter Stones

- Many flywheel grinders have lower mounting flanges that won't fit inside 3" and 4" diameter flared-cup stones
- Use this adaptor to avoid damage when mounting small stones
- Fits most small diameter stones
- Order No. **FG-FLANGE** Jobber \$43.99

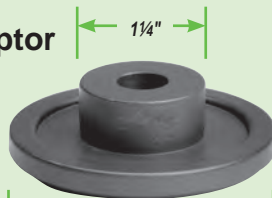

CYLINDER HEAD
REBUILDING
MISCELLANEOUS
TOOLS & SUPPLIES
BRAKE SERVICE
TOOLING
MEASURING
TOOLS
V-TWIN & METRIC
HARD PARTS

CYLINDER HEAD REBUILDING
CLEANING, ASSEMBLY & SAFETY
SHORT BLOCK REBUILDING
CRANKSHAFT/ FLYWHEEL GRINDING
MISCELLANEOUS TOOLS & SUPPLIES
BRAKE SERVICE TOOLING
MEASURING TOOLS
V-TWIN & METRIC HARD PARTS



A TYROLIT Company



tech tips
from the techxperts™
Never dress your Superabrasive with the dresser attachment on your machine



FlyMaster® CBN Super Abrasive Flywheel Grinding Wheels

• For cast iron • Light to heavy applications

(A / B x C x Arbor)	Abrasive	Shape	Grit	Jobber	Order No.
2" / 1 3/8" x 7/8" x 3/8"	CBN	Straight	100	\$127.99	2H0998
3" / 2" x 1 1/4" x 1 1/4"	CBN	Cup	100	219.99	261453
3 3/4" / 2 5/8" x 1 1/2" x 1 1/4"	CBN	Cup	100	221.99	2371052
3 3/4" / 2 5/8" x 1 1/2" x 1 1/4"	CBN	Cup	60	205.99	34296362
5" / 3 3/4" x 1 3/4" x 1 1/4"	CBN	Cup	100	219.99	2379270
6" / 4 5/8" x 1 7/8" x 1 1/4"	CBN	Cup	100	221.99	2367275*
6" / 4 5/8" x 1 7/8" x 1 1/4"	CBN	Cup	60	229.99	2G7480
CBN Dressing Stick 1/2" x 1/2" x 6"				17.99	DS-CBN

*Most popular application

Diamond Flywheel Grinding Wheel

- For hard, spray coated floaters and flywheels
- 6" / 4 5/8" x 1 7/8" x 1 1/4"
- Order No. **2E5742** Jobber \$199.99



Order 5 or more
Flywheel Grinding Stones
(any combination) and SAVE
10% off Jobber

tech tips

from the techxperts™

How to Measure A Flywheel Stone

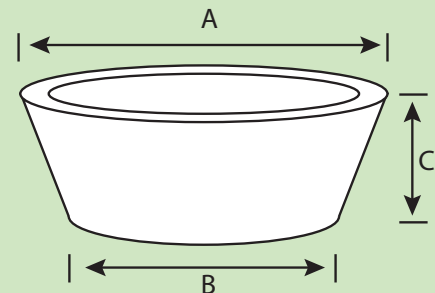

Flywheel Grinding Stones

• Four Abrasive formulas to choose from

SILICON-CARBIDE ABRASIVE

Ductile Iron, Cast Iron & Steel (Black)

(A / B x C x Arbor)	Hardness	Shape	Jobber	Order No.
3" / 2 1/2" x 1 1/2" x 1 1/4"	Med. Hard	Flared	\$39.99	U364512
4" / 3" x 2" x 1 1/4"	Med. Soft	Flared	69.99	U335369
6" / 4 1/2" x 2 1/2" x 1 1/4"	Med. Soft	Flared	47.99	U324495
	Med. Hard	Flared	51.99	U335376
	Hard	Flared	47.99	U335377
6" / 4 1/2" x 2 1/2" x 1 1/4"	Med. Soft	Flared	51.99	U357854
	Med. Hard	Flared	62.99	U343805
6" / 4 3/4" x 3" x 1 1/4"	Med. Hard	Flared	51.99	U69693

BIG BRUTE!

EXTENDED LIFE CERAMIC

Ductile Iron, Cast Iron and Steel (Black)

(A / B x C x Arbor)	Hardness	Shape	Jobber	Order No.
6" / 4 1/2" x 3" x 1 1/4"	Med. Hard	Flared	\$109.99	U370095

ALUMINUM-OXIDE ABRASIVE

Mild Steel & Hardened Steel (White)

(A / B x C x Arbor)	Hardness	Shape	Jobber	Order No.
6" / 4 1/2" x 2 1/2" x 1 1/4"	Soft	Flared	\$99.99	F342636

ALUMINUM-OXIDE ABRASIVE

Light to Medium Stock Removal on Steel, Cast Iron & Ductile Iron (Ruby)

(A / B x C x Arbor)	Hardness	Shape	Jobber	Order No.
4" / 3" x 2" x 1 1/4"	Medium	Flared	\$59.99	F348769
6" / 4 1/2" x 2 1/2" x 1 1/4"	Soft	Flared	62.99	F372039
	Med. Soft	Flared	64.99	F348771
	Medium	Flared	67.99	F348772
	Hard	Flared	66.99	F348773

Colors may vary due to the manufacturing process



Deburring Tool

- Swivel tool chamfers sharp, machined edges, bolt holes, and much more
- DT-6 includes cutters for aluminum and cast iron

Description	Jobber	Order No.
Deburring Tool	\$20.99	DT-6
Replacement Cutters		
Steel/Aluminum	\$5.99	DT-10
Cast Iron/Brass	5.99	DT-20

14mm Spark Plug Thread Chaser

- Ideal for spark plug hole cleaning
- Re-forms the original material by burnishing, not cutting, and won't create new chips to clean out
- Order No. **SPB-14** Jobber \$102.99

Burr Buster

- Use on air float tables, seat & guide machines, beds of crankshaft grinders and flywheel grinder tables
- Deburrs gasket surfaces on heads, blocks, manifolds, etc.
- 120 grit premium grade abrasive
- 1½" x 2¾" x 9"
- Order No. **BB-9** Jobber \$24.99



Bench Grinder Wheels

- 40 and 60 grit for general grinding
- 100 grit for sharpening carbide tools
- Includes bushings to reduce arbor hole from ¾" to ½"
- PLUS a ⅝" bushing adaptor



Size	Grit	Jobber	Order No.
General Purpose Wheels: For steel and cast iron			
6" x ¾"	60	\$20.99	GG-666
6" x 1"	60	23.99	GG-686
7" x 1"	40	25.99	GG-784
8" x 1"	40	30.99	GG-884
8" x 1"	60	32.99	GG-886
Green Grit Wheels: For sharpening carbide tools			
6" x ½"	100	\$30.99	GGC-641
6" x ¾"	100	29.99	GGC-661
6" x 1"	100	34.99	GGC-681



Grinding Wheel Star Dressers

Description	Jobber	Order No.
Hand dresser for wheels up to 10" dia.	\$19.99	GS-0
Replacement Cutter Sets		
4 blades, 2 spacers, ¼" ID for GS-0 dresser	\$7.99	GS-00
4 blades, 2 spacers, ½" ID for GS-1 dresser	8.99	GS-11

Deburring Wheels for Bench Grinders

- Medium-hard wheels are better suited for heat sensitive materials
- Use to clean and polish white metal
- Buff and Blend Wheels deliver the same results as a wire brush but are much safer to work with

Description	Size	Qty.	Jobber	Order No.
Medium-Hard Deburring Wheel	6" x 1" x 1"	1	\$89.99	SCW-68M
Buff and Blend Wheels	6" x ½" x 1"	5	18.99	BBD-65

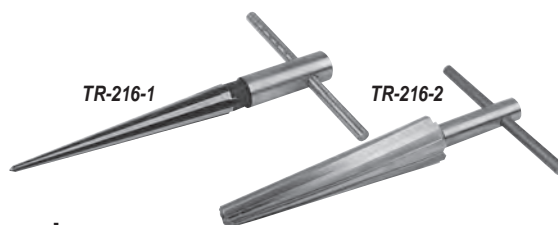

Premium Tapered Reamers

- Use by hand or with a powered driver to deburr or enlarge tapered holes for tie-rod ends or ball joints
- Use in ½" chuck at approximately 40 RPM

OAL	Flute	Small End	Big End	Taper	Jobber	Order No.
5¾"	3¾" long	⅛" dia.	½" dia.	—	\$36.99	TR-216-1
6½"	4½" long	⅞" dia.	1" dia.	1½" per ft.	137.99	TR-216-2

new

Maxxeon WorkStar™ 320 LED Compact Inspection Light

- 5" inspection light weighs just 2 ounces
- Black anodized T6 aluminum body
- Operating temperature: 15° to 105°F (-10° to +40°C)
- Runs on 2-AAA alkaline batteries (included)
- Also compatible with NiMH and Li-ion batteries
- 1 year warranty against manufacturing defects
- Order No. **DFL-320** Jobber \$37.99



Maxxeon WorkStar™ 420 Inspector Maxx Rechargeable Work Light

- 6 inline LEDs with a custom lens creates a huge floodlight beam - no rings, no shadows, no hot spots
- Worklight = 200 lumens, Flashlight = 135 lumens
- Rechargeable battery (not replaceable, USB charger cord included)
- Measures: 7"L x 7/8"W x 1/2" Thick • Weighs 2.2 ounces
- Order No. **DFL-420** Jobber \$34.99



CYLINDER HEAD REBUILDING
CLEANING, ASSEMBLY & SAFETY
SHORT BLOCK REBUILDING
CRANKSHAFT/FLYWHEEL GRINDING
MISCELLANEOUS TOOLS & SUPPLIES
BRAKE SERVICE TOOLING
MEASURING TOOLS
V-TWIN & METRIC HARD PARTS

Diamond Dresser Tools

shown at approximately full size

CYLINDER HEAD
REBUILDING

CLEANING,
ASSEMBLY & SAFETY

SHORT BLOCK
REBUILDING

CRANKSHAFT/
FLYWHEEL GRINDING

MISCELLANEOUS
TOOLS & SUPPLIES

BRAKE SERVICE
TOOLING

MEASURING
TOOLS

V-TWIN & METRIC
HARD PARTS

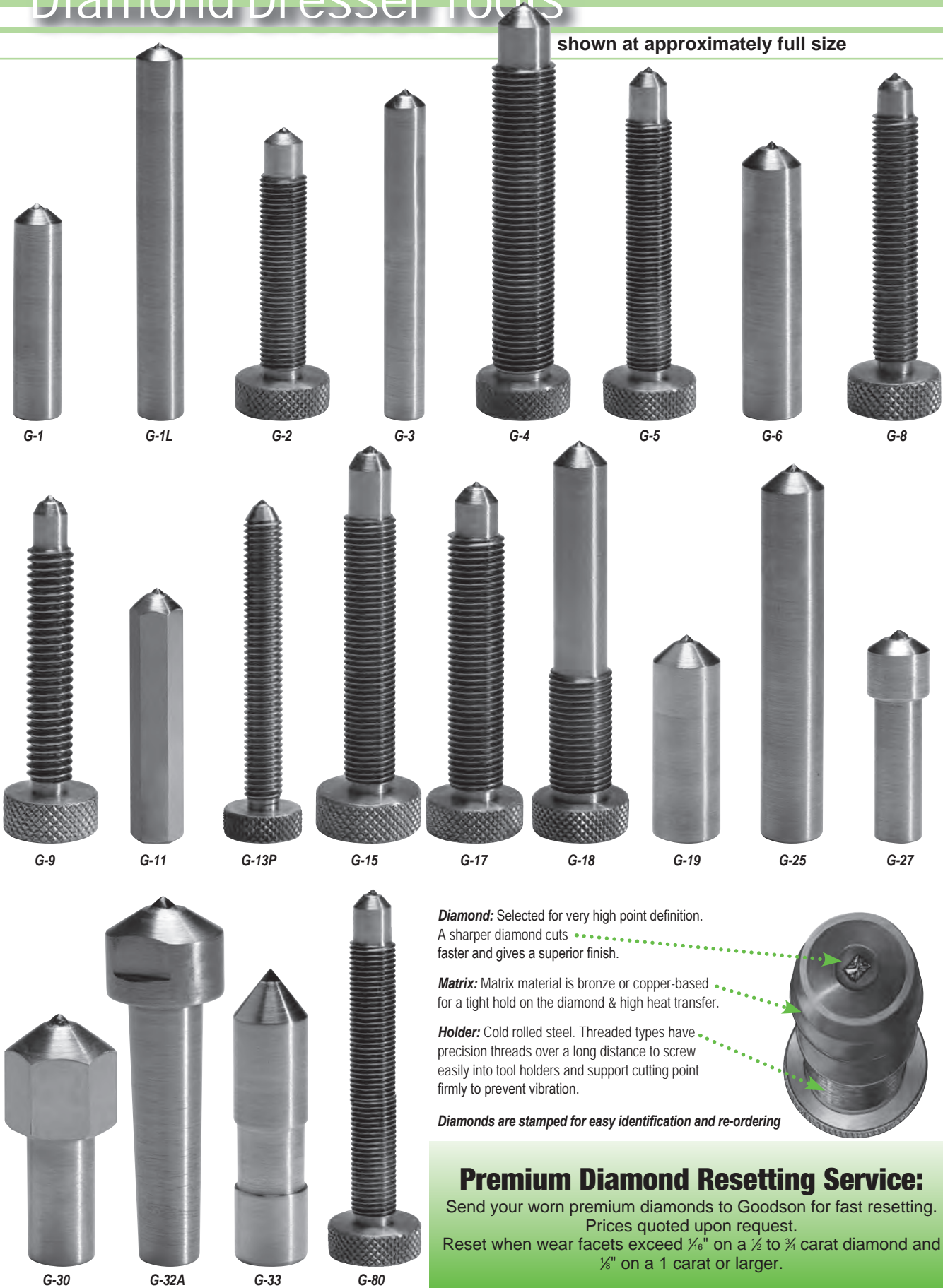

Diamond: Selected for very high point definition. A sharper diamond cuts faster and gives a superior finish.

Matrix: Matrix material is bronze or copper-based for a tight hold on the diamond & high heat transfer.

Holder: Cold rolled steel. Threaded types have precision threads over a long distance to screw easily into tool holders and support cutting point firmly to prevent vibration.

Diamonds are stamped for easy identification and re-ordering

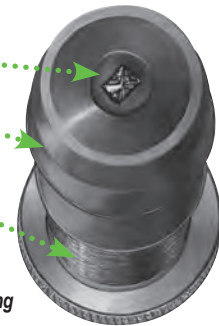

Premium Diamond Resetting Service:

Send your worn premium diamonds to Goodson for fast resetting. Prices quoted upon request. Reset when wear facets exceed $\frac{1}{16}$ " on a $\frac{1}{2}$ to $\frac{3}{4}$ carat diamond and $\frac{1}{8}$ " on a 1 carat or larger.

Diamond Dressers for most shop machines are in stock and ready-to-ship

A diamond tool is only as good as the diamond itself. GOODSON diamonds are furnished by the most respected supplier in the U.S. Each is subjected to a microscopic examination by experts and must meet strict standards to be accepted. This rigorous inspection and careful control during manufacturing assures consistent high quality. Our diamond tools deliver the highest levels of performance and longevity.

In addition to our standard diamond tools, GOODSON stocks a wide selection of Premium Quality diamonds. These diamonds last longer and improve wheel performance. They stay sharp longer and have more points so they can be reset more times. Because of this quality, they will dress harder wheels and wheels will need to be dressed less frequently. If you don't see the diamond you need in a premium quality, call 1-800-533-8010 for a special order.

	Machine	Description	Carat	Jobber	Standard	Jobber	Premium	
Valve Refacers	B&D, Skil, Sioux™, Thor, VanDorn, WVN	3/8" x 1 1/8"	1/6	\$ 37.99	G-1	\$ 74.99	G-1P	
	Kwik-Way, Tobin Arp (S&D)	5/16" x 2 1/2"	1/6	37.99	G-3	---	---	
	Kwik-Way, Valve Master (1714)	1/2" x 3 1/4" 20NF	1/6	39.99	G-4	---	---	
	Sioux™ (1713, 1715), IDL, WVN (CG50, CG80)	3/8" x 2 3/4" 24NF	1/6	39.99	G-5	74.99	G-5P	
	IDL, WVN (CG-50, CG-80)	3/8" x 3 1/4" 24NF	1/6	44.99	G-80	82.99	G-80P	
	US	7/16" x 2"	1/6	37.99	G-6	---	---	
	Skil (Talent)	5/16" x 2 1/4" 18NC	1/6	39.99	G-9	---	---	
	Kwik-Way	7/16" x 2 3/4" 20NF	1/6	37.99	G-17	74.99	G-17P	
	Valve Seat Grinders	B&D, S&D, Van Dorn	3/8" x 2 1/4" 24NF	1/6	39.99	G-2	---	---
		Kwik-Way	1/2" x 3 1/4" 20NF	1/6	39.99	G-4	---	---
Sioux™ (1715), K-W (NSG), Thor		3/8" x 2 3/4" 24NF	1/6	39.99	G-5	74.99	G-5P	
Hall HD (13-1938P), Skil, Snap-On, B&D		5/16" x 2 1/4" 24NF	1/6	43.99	G-8	72.99	G-8P	
KO Lee, Skil		5/16" x 2 1/4" 18NC	1/6	39.99	G-9	---	---	
Sioux™ Heavy Duty (1715B, 1719)		3/8" hex RH	1/6	59.99	G-11	---	---	
Goodson Universal Wheel Dresser		8mm x 1.25mm	1/6	---	---	84.99	G-13P	
Sioux™ Heavy Duty (1715A)		3/8" x 2 3/4" 24NF	1/2	77.99	G-15	---	---	
Kwik-Way Heavy Duty Wheel Dresser		1/2" x 3" 20NF	1/6	37.99	G-18	70.99	G-18P	
Clutch Grinders		Lempco AC, NAC, VAC & Do-ALL	7/16" x 2"	1/6	37.99	G-6	---	---
Piston Grinders	Van Norman 75, 76 & Relio	3/8" x 1 1/8"	1/6	37.99	G-1	74.99	G-1P	
	Storm-Vulcan D-3	7/16" x 2"	1/6	37.99	G-6	---	---	
Drum Lathes	Van Norman (all except 302, 302H)	3/8" x 1 1/8"	1/6	37.99	G-1	74.99	G-1P	
	Barret, V.N. 302, 302H	3/8" x 3"	1/6	37.99	G-1L	---	---	
	Lempco	7/16" x 2"	1/6	37.99	G-6	---	---	
	Ammco 5000	1/2" x 1 1/2"	1/6	39.99	G-19	---	---	
Rod Grinders	Sunnen® Rod & Cap Grinder (CRG-500)	3/8" x 1 1/8"	1/6	37.99	G-1	74.99	G-1P	
	Storm-Vulcan No. 65 Rod Grinder	1/2" x 3 1/4" 20NF	1/6	39.99	G-4	---	---	
Crank & Cam Grinders	Storm-Vulcan 14, 15, 15A, 15C, 75, 75A	1/2" x 3"	3/4	135.99	G-25	---	---	
		1/2" x 3"	1	185.99	G-25A	---	---	
	Sclodum	10mm x 1 1/8"	3/4	136.99	G-27	---	---	
	Winona Van Norman/Zanrosso,	7/16" x 1 1/4", 5/8" head	3/4	136.99	G-30	---	---	
	Lempco, Landis	7/16" x 1 1/4", 5/8" head	1	194.99	G-30A	---	---	
	Berco	tapered, step type	1	203.99	G-32A	319.99	G-32AP	
	Berco	tapered, step type	1 1/2	329.99	G-32B	---	---	
	Storm-Vulcan, WVN CG210, 250, 280	1/2" x 2" 70° radius dress	3/4	249.99	G-33	---	---	
	Universal Cluster Dresser (photo pg. 93)	7/16" x 1 1/6", 15°		117.99	2V9507	---	---	
	Flywheel Grinder	Kwik-Way 796	7/16" x 2"	1/6	37.99	G-6	---	---

tech tips

from the techxperts™

- 1. Set tool at a proper angle.** Position at 10° to 15° from surface. Smaller angles blunt the diamond. Larger angles may cause the wheel to remove matrix material.
- 2. Prevent vibration in the holder.** Any looseness in the tool holder will allow vibration of the tool resulting in poor finish on the wheel.

- 3. Turn coolant on before dressing.** Wheels used wet should be dressed wet. To keep diamond cool, turn coolant on before starting to dress. (If wheel is dressed dry, air-cool diamond between cuts but don't quench with water.)
- 4. Start at highest point.** Wheels often wear unevenly & may have high & low spots. Set tool to dress high spots first, feed in about .001" per pass until done. This prevents overheating & damage.

- 5. Use steady travel.** Uneven travel causes an uneven finish. The best rate is found by experiment, but whatever the rate of travel, it must be even.
 - 6. Turn the tool in the holder.** Turn the tool often to expose new diamond surface to the wheel.
 - 7. Don't bump or drop diamond.** They are hard but brittle, and can be harmed if dropped or bumped.
- CAUTION: Grinding Wheel must never touch the matrix or holder.**

CYLINDER HEAD REBUILDING
CLEANING, ASSEMBLY & SAFETY
SHORT BLOCK REBUILDING
FLYWHEEL GRINDING
CRANKSHAFT/ FLYWHEEL GRINDING
MISCELLANEOUS TOOLS & SUPPLIES
BRAKE SERVICE TOOLING
MEASURING TOOLS
V-TWIN & METRIC HARD PARTS



"Be sure to check out the Goodson website (goodson.com) for product specials, tech tips, Safety Data Sheets and much more."

- Janet, Goodson Advertising Manager, 18 years of service

CYLINDER HEAD
REBUILDING



Replacement Bearing Cap for Sioux™ 1710 Electric Driver

• Order No. **SX-23694**
Jobber \$54.99

CLEANING,
ASSEMBLY & SAFETY

Replacement Brush Set for Sioux™ 1710 Electric Driver

• Carbon brushes for armature
• Measure 3/8" x 1/2"
• Order No. **SX-18004**
Jobber \$29.99



SHORT BLOCK
REBUILDING



Replacement Switch for Sioux™ 1710 Electric Driver With Plastic Handle

• 125/250 VAC or 125VDC
• 2 Pole • Measures 1.87"L x 0.875"W x 1.07"H
• Order No. **SX-18204**
Jobber \$33.99

CRANKSHAFT/
FLYWHEEL GRINDING

Replacement Bearing Cap for Sioux™ 1792 Pneumatic Driver

• Order No. **SX-33970**
Jobber \$54.99



MISCELLANEOUS
TOOLS & SUPPLIES

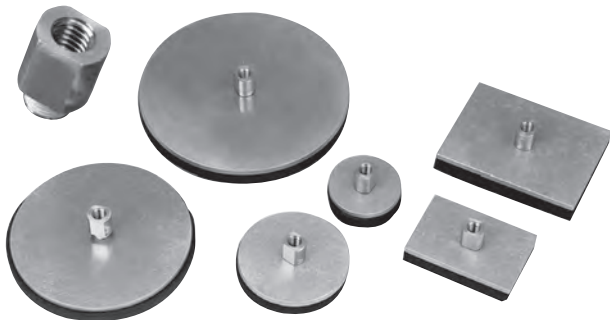

Sioux-Style Replacement Vacuum Tester Parts

• For Sioux™ 1630K Tester which is no longer manufactured
• Closed cell foam for an exceptional seal



Sioux-Style Replacement Plates for the 1630K Tester			
Size	OE No.	Jobber	Order No.
2" / 50.8mm dia.	1630-2	\$31.99	SVT-2
3" / 76.2mm dia.	1630-3	33.99	SVT-3
4.75" / 120.7mm dia.	1630-4	31.99	SVT-475
6" / 152.4mm dia.	1630-6	34.99	SVT-6
2"x3" / 50.8 x76.2mm		31.99	SVT-23
3x4" / 76.2 x101.6mm		32.99	SVT-34
Replacement Parts for the 1630K Tester			
Replacement Fitting		\$13.99	DVC-SX
Replacement Gauge		41.99	1630-GAUGE

BRAKE SERVICE
TOOLING

MEASURING
TOOLS

V-TWIN & METRIC
HARD PARTS

Sioux-Style Pilots & Bushings

• Replacement parts for the popular 1716 Seat Wheel Dresser no longer available from Sioux™
• .375" top pilot features a groove to fit Black & Decker holders

Riser Bushings

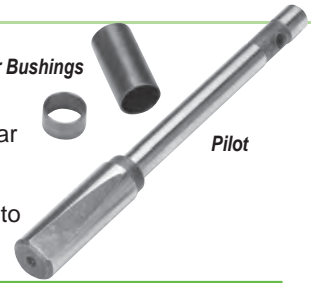

Pilot

Description	Jobber	Order No.
.385" Top Pilot	\$69.99	1718A
.375" Top Pilot	74.99	1718-BD
.572" Dressing Stand Pilot for Sioux™ 1716 Dresser	79.99	1718-B
Riser Bushings (2) for .385" Pilots	9.99	SK-9-10
Riser Bushings (2) for .572" Pilots	10.99	SK-11-12

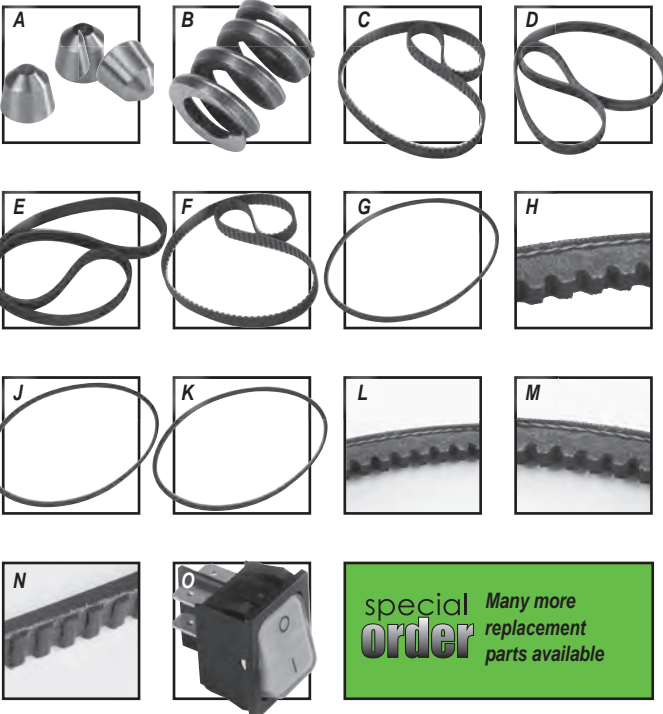

special order Many more replacement parts available

Replacement Parts for Sioux™ Valve Refacers

Description	Fits Model No.	Jobber	Order No.
A - Chuck Balls (3 pc.)	680, 2075	\$209.99	24185
B - Chuck Springs (9 Pc.)	680, 2075	113.99	SX-53615
C - Cog Style 24"x1/2" 120 teeth	680	28.99	SX-14467
D - Serpentine 29% ¹ / ₂ " x 1/2" 5 grooves	680	36.99	SX-14471
E - Spindle Belt 28% ¹ / ₂ " x 1/2" 5 groove	2075	36.99	SX-65117
F - Chuck Belt 23% ¹ / ₂ " x 1/2", 115 teeth	2075	18.99	SX-14473
G - Replacement Belt for Grinding Head Fits Serial #s up to 34999 (2 belts)	645	54.99	SX-14400
H - Chuck Belt Fits Serial #s 34999 & up (also coolant pump belt for #s 35217 & up).	645	20.99	SX-14401
J - Belt for Motor Shaft; Fits Serial #s up to 34999	645	28.99	SX-14402
K - Coolant Pump Belt; Fits Serial #s 34999-35216	645	28.99	SX-14403
L - Belt for Motor Shaft; Fits Serial #s 35000 & up	645	41.99	SX-14445
M - Replacement Belt for Grinding Head; Fits Serial #s 35000-58700	645	32.99	SX-14453
N - Replacement Belt for Grinding Head; Fits Serial #s 58701 & up	645	39.99	SX-14461
O - Replacement Switch (1100V, AC)	2001, 2075	56.99	SX-18221

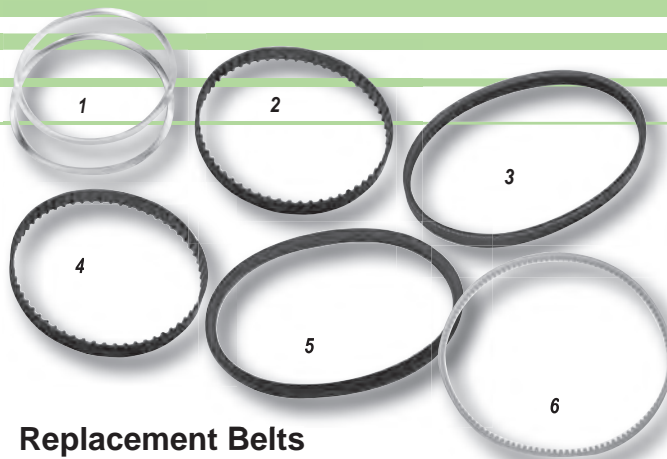

Replacement Belts For Kwik-Way Valve Refacers

Application	Machine	Jobber	Order No.
1 Spindle Belt 14.5" L "O" Ring - 1 Pr.	SVS II	\$17.99	000-2303-62
2 Chuck Belt 10" Cog, 50 tooth	SVS II	22.99	001-1899-90
3 Spindle Belt 18" Serpentine	SVS	37.99	001-1905-20
4 Chuck Belt 12" Cog, 60 tooth	SVS or VS	25.99	001-1899-99
5 Spindle Belt 16" V-Belt	VS	22.99	001-1900-67
6 Chuck Belt 19" 120 tooth	VS	29.99	001-1900-75

Replacement Chuck Balls For Kwik-Way Valve Refacers

- Measure chuck ball diameter before ordering to ensure correct replacement
- 6 per set



Diameter	Jobber	Order No.
1/2"	\$43.99	010-2101-27
17/32"	37.99	010-2101-35

enlarged to show detail

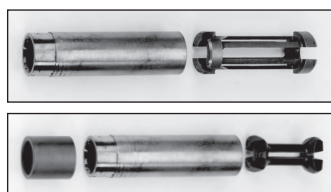

- ◀ Collet is unavailable from OE
- ◀ Replace with two-piece set

Collet for Black & Decker™ Valve Refacers

- Two-piece set replaces the Black & Decker Twin Grip collet (no longer available)
- Remove the damaged, worn or broken collet and replace with this set
- Accommodates 1/4" (6.35mm) to 3/8" (9.53mm) valve stems
- Order No. **BVR-38** Jobber \$207.49

Can't Find A Replacement Part For Your Machine?

Contact The
Goodson Techxperts™
To Put Them To Work For You!

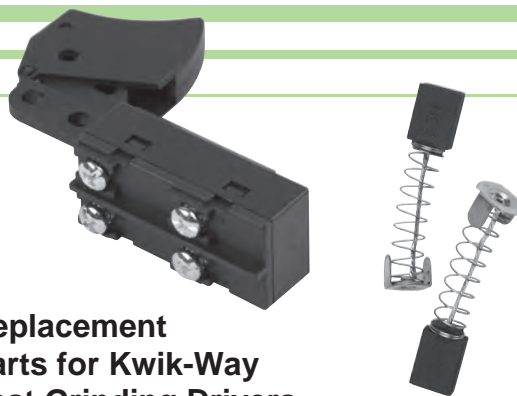

Replacement Parts for Kwik-Way Seat Grinding Drivers

Description	Jobber	Order No.
Trigger Switch	\$39.99	000-1201-20
2 Pc. Brush Set	29.99	003-0072-43

See page 19 for Seat Grinding Drivers

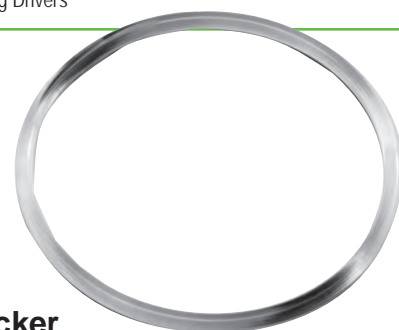

Replacement Chuck Belt For Black & Decker

- Chuck belt for the aluminum housing unit • Replaces OE V-type belt
- .200" thick x 12 3/4" long (5.08mm x 323.85mm)
- Order No. **BVR-B** Jobber \$27.99



Valve Refacer Steady Rest Shoes for Sunnen® VR-7000 & VR-8000

- Sold by the pair
- Order No **SUN-1202A** Jobber \$69.99

How to Build and Modify GM LS-Series Engines

This manual includes information on cylinder head preparation, camshafts, rotating assemblies, assembly and induction/nitrous.
Order No. **MA-148**
Jobber \$30.99



CYLINDER HEAD REBUILDING
CLEANING, ASSEMBLY & SAFETY
SHORT BLOCK REBUILDING
CRANKSHAFT/ FLYWHEEL GRINDING
MISCELLANEOUS TOOLS & SUPPLIES
BRAKE SERVICE TOOLING
MEASURING TOOLS
V-TWIN & METRIC HARD PARTS



"If you need engine building tools and supplies, you need Goodson! We're dedicated to providing you with the best quality products, the best value and the best service in the industry."

- Mike, Goodson Purchasing - 2 years of service

CYLINDER HEAD
REBUILDING

CLEANING,
ASSEMBLY & SAFETY

SHORT BLOCK
REBUILDING

CRANKSHAFT/
FLYWHEEL GRINDING

MISCELLANEOUS
TOOLS & SUPPLIES









BRAKE SERVICE
TOOLING

MEASURING
TOOLS

V-TWIN & METRIC
HARD PARTS

Brake Lathe Tip Holders

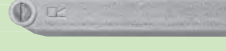
If you're looking for a holder that isn't listed here, call **1-800-533-8010** to see if we can get it for you. All holders include 1 tip.

Machine	Model	Use	OE No.	Jobber	Order No.
Ammco	1000, 2002, 3000, 4000, 4100, 7500, 7700	For Drums 1/2" x 3/8" x 2 1/4"	9872	\$18.99	TAM-41R
All-Tool	747	Use: RT-A series, negative rake tips			
Hoffman	660				
Performance	6600, 7200, 7100, 7600				
Ammco	3000, 3850, 4000, 4100, 7000 & 6900, 6950 Twin Cutters	For Rotors 3/8" x 3/8" x 1 1/8"	10701	14.99	TAM-701 (R)
Performance	6600, 7200, 7100, 7600	Use: RT-A series, negative rake tips			
Hoffman	660				
All-Tool	747				
Ammco	3000, 3850, 4000, 4100, 7000 & 6900, 6950 Twin Cutters	For Rotors 3/8" x 3/8" x 1 1/8"	25968	24.99	TAM-25968 (R)
		Use: RT-3A & RT-3AS series, positive rake tips			
Bear	1410, 1466, 1467, 1468, 1469, 14781	Drums and Rotors 3/8" x 3/8" x 3"	90495	19.99	TBR-44R (R)
		Use: RT-B series, negative rake tips			
Ammco	Direction: Left	3/8" x 3/8" x 1 1/8"		19.99	TAM-312L*
Hoffman	Direction: Right	3/8" x 3/8" x 1 1/8"			
Performance, All-Tool		Use: RT-312 series tips			
Ammco	Direction: Left	3/8" x 3/8" x 1 1/8"		26.99	DTAM-312L
Hoffman	Direction: Right	3/8" x 3/8" x 1 1/8"			
Accu-turn	Direction: Left	3/8" x 3/8" x 2 3/4"			
FMC, Bear, Hoffman, Kwik-Way, Snap-On, etc.	Direction: Right	3/8" x 3/8" x 2 3/4"		19.99	TFM-312L*
		Use: RT-312 series tips			
Accu-turn	Direction: Left	3/8" x 3/8" x 2 3/4"			
FMC, Bear,	Direction: Right	3/8" x 3/8" x 2 3/4"		26.99	DTFM-312L
					

*While Supplies Last

Measurements for Solid Carbide, Honed Edge Carbide & Titanium Coated Carbide Cutting Tips

GOODTOOL
Now exclusively from Goodson

Measure to Find the Right Tip

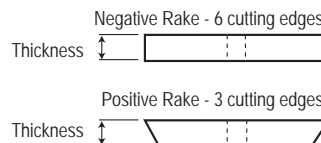
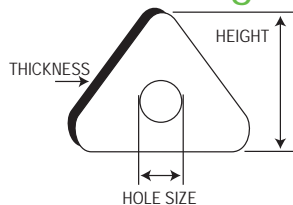
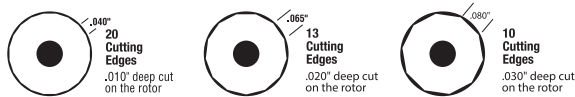

RT-A Height: .350" Thick: .095" Hole: .135" Rake: NEG	RT-3AS Height: .357" Thick: .104" Hole: .127" Rake: POS	RT-3A Height: .343" Thick: .093" Hole: .133" Rake: POS	RT-373 Height: .625" Thick: .125" Hole: .117" Rake: POS	RT-AC Height: .445" Thick: .131" Hole: .145" Rake: POS	RT-FMC Height: .452" Thick: .125" Hole: .090" Rake: POS	RT-B Height: .343" Thick: .105" Hole: .130" Rake: NEG
RT-HF Height: .714" Thick: .185" Hole: .200" Rake: NEG	RT-KW Height: .358" Thick: .101" Hole: .125" Rake: POS	RT-H Height: .344" Thick: .125" Hole: .090" Rake: NEG	RT-HNT Height: .312" Thick: .103" Hole: .127" Rake: POS	RT-MRH Diameter: .235" Thick: .125" Hole: .108" Rake: POS	RT-VBG Height: .344" Thick: .098" Hole: .124" Rake: POS	RT-VN Height: .545" Thick: .125" Hole: N/A Rake: POS
RT-VNS Height: .547" Thick: .121" Hole: N/A Rake: POS	RT-VNH Height: .545" Thick: .095" Hole: .135" Rake: NEG	RT-VNA Height: .535" Thick: .188" Hole: .148" Rake: NEG	RT-KWL-T Height: .338" Thick: .100" Hole: .123" Rake: POS	RT-VNP-L OR -R Height: .902" Thick: .100" Hole: N/A Rake: POS	RT-312 Diameter: .311" Thick: .100" Hole: .150" Rake: POS	RT-360 Height: .311" Thick: .100" Hole: N/A Rake: POS

Tips Are Shown Actual Size

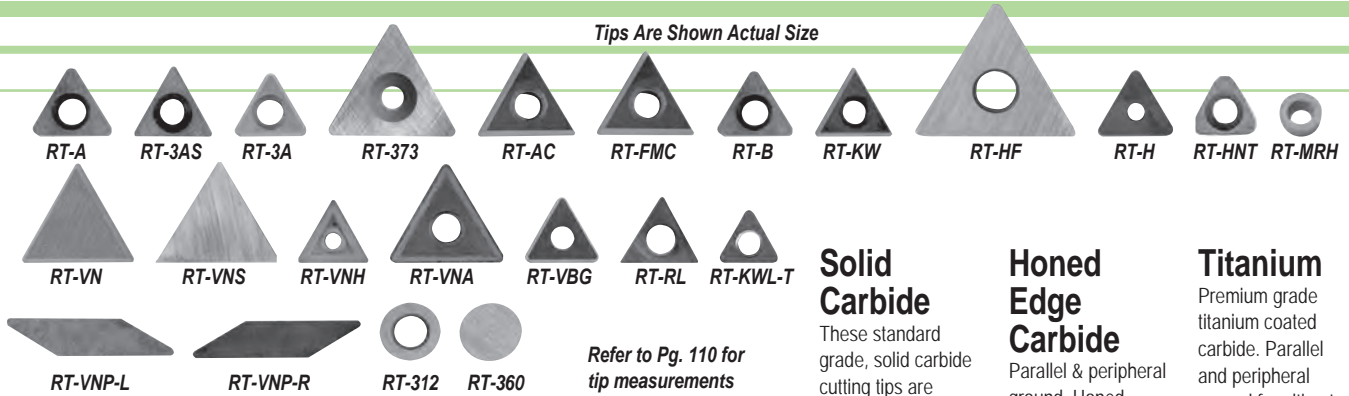

Refer to Pg. 110 for tip measurements

Solid Carbide

These standard grade, solid carbide cutting tips are parallel ground for resurfacing cast iron drums and rotors.

Honed Edge Carbide

Parallel & peripheral ground. Honed edges deliver a better finish on cast iron and composite rotors.

Titanium

Premium grade titanium coated carbide. Parallel and peripheral ground for ultimate performance on cast iron & composite rotors.

The more you buy, the more you save!
Order 3 or more 10-packs, save 10% off jobber



*While supplies last

Machine	Model(s)	OE No.	Edges	Rake	Screws	Jobber	Order No.	Jobber	Order No.	Jobber	Order No.
Ammco	700, 710, OTC Lathes, 1000, 2002, 3000, 4000, 4100, 7000, 7500, 7700	6914	6	Neg	Yes	\$2.99	RT-A	\$3.49	RT-A-H	\$3.99	RT-A-T
	3850 smaller (1/4") radius	6918	3	Pos	Yes	4.49	RT-3AS	4.99	RT-3AS-H	5.99	RT-3AS-T
	larger (1/2") radius	7681	3	Pos	Yes	4.49	RT-3A	4.99	RT-3A-H	5.99	RT-3A-T
Twin Cutters:	6900,6950 negative rake (std.)	6914	6	Neg	Yes	2.99	RT-A	3.49	RT-A-H	3.99	RT-A-T
	positive rake (standard) 1/4" (finer finish)	6918	3	Pos	Yes	4.49	RT-3AS	4.99	RT-3AS-H	5.99	RT-3AS-T
	positive rake (modified) 1/2" (more durable)	7681	3	Pos	Yes	4.49	RT-3A	4.99	RT-3A-H	5.99	RT-3A-T
	7900	6914	6	Neg	Yes	2.99	RT-A	3.49	RT-A-H	3.99	RT-A-T
Ammco HD	5000, 6000, 6002	5677	3	Pos	No	10.99	RT-373	—	—	—	—
Accu-Turn	All combination disc/drum lathes	433796	3	Pos	Yes	4.79	RT-AC	4.89	RT-AC-H	4.99	RT-AC-T
	On-The-Car Lathes	878051	6	Neg	Yes	2.99	RT-A	3.49	RT-A-H	3.99	RT-A-T
All-Tool	747	3331	6	Neg	Yes	2.99	RT-A	3.49	RT-A-H	3.99	RT-A-T
Bean	B-401, B-410, B-501, B-601	90487	3	Pos	Yes	3.99	RT-FMC	4.99	RT-FMC-H	5.99	RT-FMC-T
Bear	1410,1466,1467,1468, 1469, 1478	2264,72265,772834	6	Neg	Yes	2.99	RT-B	*2.49	RT-B-H	—	—
	10-1430, 10-1435	W136	6	Neg	No	10.49	RT-HF	—	—	—	—
FMC	600, 601, 700, 701, RotoTruer	90487	3	Pos	Yes	3.99	RT-FMC	4.99	RT-FMC-H	5.99	RT-FMC-T
	505, On-The-Car Lathe	91212	3	Pos	Yes	3.99	RT-KW	4.59	RT-KW-H	4.99	RT-KW-T
Hoffman	660	3331	6	Neg	Yes	2.99	RT-A	3.49	RT-A-H	3.99	RT-A-T
Horvath	All	1605	6	Neg	No	*2.49	RT-H	—	—	—	—
Hunter	BL300 On-The-Car Lathe	221580-2	6	Neg	Yes	2.99	RT-A	3.49	RT-A-H	3.99	RT-A-T
	BL-500, BL-501, BL-505	6918	3	Pos	Yes	4.49	RT-3AS	4.99	RT-3AS-H	5.99	RT-3AS-T
	BL-500	221-678-3	3	Pos	Yes	4.99	RT-HNT	—	—	—	—
	Micro Tips of OCL-400 Lathe	221-626-3	3	Pos	Yes	7.99	RT-MRH	—	—	—	—
Kwik-Way	CBL, NCL, SDL Kwik-Lathe OTC Lathe	109-1092-23	3	Pos	Yes	3.99	RT-KW	4.59	RT-KW-H	4.99	RT-KW-T
	Lightening Lathe	109-1092-45	3	Pos	Yes	—	—	—	—	7.99	RT-KWL-T
Performance	6600,7200,7100, 7600	3331	6	Neg	Yes	2.99	RT-A	3.49	RT-A-H	3.99	RT-A-T
Pro-Cut	On-The-Car Lathe	50-701, 50-742	3	Pos	Yes	3.99	RT-VBG	4.49	RT-VBG-H	4.99	RT-VBG-T
RJ West	915D Disc Lathes	W136	6	Neg	No	10.49	RT-HF	—	—	—	—
	Perfect 400, 1115HD	W139	3	Pos	Yes	4.79	RT-AC	4.89	RT-AC-H	4.99	RT-AC-T
RTI	BRC35 On-The-Car Lathe	91212	3	Pos	Yes	4.49	RT-3A	4.99	RT-3A-H	*3.49	RT-3A-T
Snap-On	YA282, YA277, YA278, YA180 OTC Lathe	109-1092-23	3	Pos	Yes	3.99	RT-KW	4.59	RT-KW-H	4.99	RT-KW-T
Van	204, 204D, 205, 205DC, 415, 243XV	29687	3	Pos	No	4.99	RT-VN	5.49	RT-VN-H	5.99	RT-VN-T
	Smaller (1/4") radius	—	3	Pos	No	4.49	RT-VNS	*3.29	RT-VNS-H	*3.49	RT-VNS-T
Norman and Rels	Older Model 204	21933	6	Neg	No	5.99	RT-VNH	—	—	—	—
	204, 304, 405	29005	6	Neg	No	7.49	RT-VNA	—	—	—	—
	303,304,305,404,405,V22	304-7167	2	Pos	No	7.99	RT-VNP-L	—	—	—	—
	204,205,205DR,300,302,333,243,243XV	302-7167	2	Pos	No	7.99	RT-VNP-R	—	—	8.99	RT-VNP-RT
	Rels 2000 rotor	45016, 45021	3	Pos	Yes	6.99	RT-RL	—	—	—	—
VBG	On-The-Car Lathe	50-701	3	Pos	Yes	3.99	RT-VBG	4.49	RT-VBG-H	4.99	RT-VBG-T
Round Tips With Hole	Fits TAM-312 and TFM-312 Holders	RT-312,RT-312T	360°	Pos	Yes	6.99	RT-312	—	—	8.99	RT-312T
	Fits TAM-360SET, TFM-360SET, RJH and CT Holders	CT10	360°	Pos	No	6.99	RT-360	—	—	8.99	RT-360T

NOTE: The table above shows the original-equipment cutting tips for Ammco machines. Most of them use negative-rake tool systems. However, some Ammco machines (especially the 4000 and 7000-series) have been modified in the field by using the TAM-25968 and TAM-25969 positive-rake tool holders (see previous page). If your machine is shown above to have 6-edge tips but has 3-edge tips, it has been modified – please order our RT-3A or RT-3AS series tips.

CYLINDER HEAD REBUILDING
CLEANING, ASSEMBLY & SAFETY
SHORT BLOCK REBUILDING
FLYWHEEL GRINDING
MISCELLANEOUS TOOLS & SUPPLIES
BRAKE SERVICE TOOLING
MEASURING TOOLS
V-TWIN & METRIC HARD PARTS

Brake Lathe Tools & Silencers

GOODTOOL
Now exclusively from Goodson



Neoprene Brake Lathe Silencer

- Longer lasting than rubber
- Neoprene material resists deterioration associated with standard rubber belts
- 7 weights
- Measures: 34" L x 5/8" W x 3/16" Thick
- Order No. **GT-6030N** Jobber \$19.99

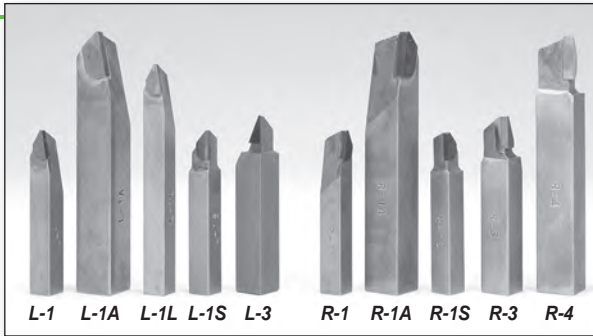

Brazed Carbide Brake Lathe Tools

- Fit most popular brake drum lathes

Left Hand Cutting Tools

Size	Application	Jobber	Order No.
3/8" sq. x 2 1/2"	Replaces Bean 43-46L; Bear 23211; Star CB-8; VN 302-7272 for 303, 304, 304H	\$11.99	L-1
5/8" sq. x 4"	Replaces Ammco 5725, for 5000; Star CB-30; VN "Big Brute" for 310-404 Hardspots	19.99	L-1A
3/8" sq. x 3 1/2"	Extra long L-1 for small dia. drums	11.99	L-1L
3/8" sq. x 2 1/2"	Master carbide-tipped with 7° rake angle	14.99	L-1S
1/2" sq. x 2 3/4"	Replaces Ammco 4726 heavy-duty tool and 3000, 4000, 4100 & 7700 lathes	14.99	L-3*

Right Hand Cutting Tools

Size	Application	Jobber	Order No.
3/8" sq. x 2 1/2"	Replaces Bean 43-46R; Bear 20718; Star LB-16; VN 302-7171 for 204, 300, 302, 302H, 333, 243XV; and Barrett & Lempcos	\$11.99	R-1
5/8" sq. x 4"	Replaces Ammco 5720 for 5000; Lempcos SHD, DH, 530 Kwik-Way Heavy Duty	19.99	R-1A
3/8" sq. x 2 1/2"	Master carbide-tipped with 7° rake angle	9.99	R-1S*
1/2" sq. x 2 3/4"	Replaces Ammco 4725 for 3000, 4000, 4100, 7100 drum lathes	9.99	R-3*
5/8" sq. x 4"	Replaces Bear 24034; Star CB-35	18.99	R-4

*While Supplies Last

Hardspot Cutters

Left Hand

Size	Use	Jobber	Order No.
3/8"x1/2"x2 3/8"	Drums	\$15.99	L-5
	Discs	9.99	L-6*

Right Hand

Size	Use	Jobber	Order No.
3/8"x1/2"x2 3/8"	Drums	\$15.99	R-5
	Discs	9.99	R-6*

* While Supplies Last



L-6 L-5 R-5 R-6

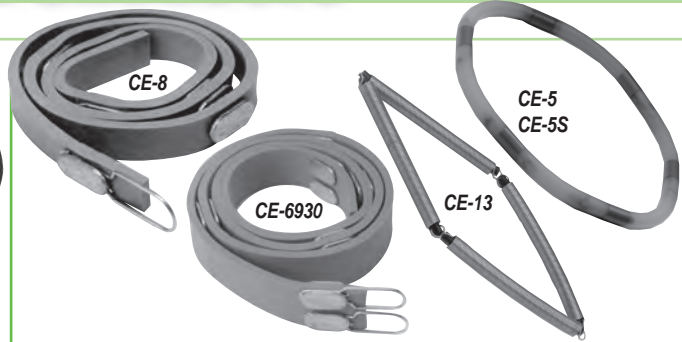

Silencers For Vented Rotors

Style	Size	OE No.	Jobber	Order No.
Rubber Strap	34"L x 5/8"W x 3/16" thick	6920	\$19.99	CE-8
	36"L x 1 1/4"W x 3/16" thick	6930	36.99	CE-6930
Spring	Fits 6" to 9" rotors		28.99	CE-13
Rubber Tube	9" Diameter, 6 weights		20.99	CE-5
	8" Diameter, 4 weights		20.99	CE-5S

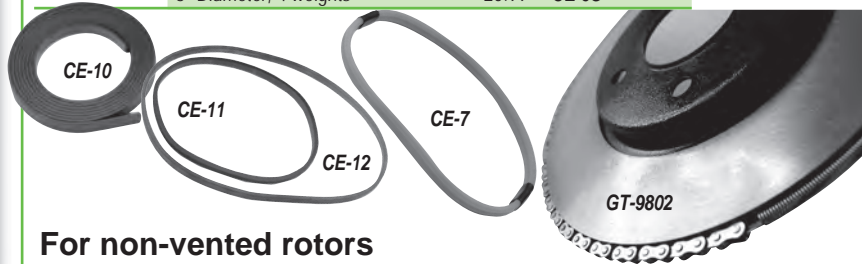

For non-vented rotors

Style	Size	Jobber	Order No.
Magnetic Strap	48" long	\$10.99	CE-10
Rubber Band	6 1/2" dia. x 5/16" W x 3/16" thick	5.99	CE-11
	9 1/4" dia. x 5/16" W x 3/16" thick	5.99	CE-12
Rubber Tube	Fits 6" to 9" rotors	7.99	CE-7
Chain Band	Nickel plated with 4-springs	61.99	GT-9802

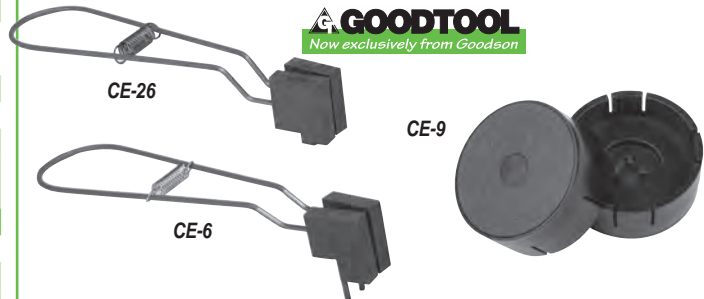

For vented and non-vented rotors

Style	Application	Jobber	Order No.
Clamp-On	For Bench model lathes	\$ 28.99	CE-6
	For On-The-Car lathes	27.99	CE-26
Friction	Replacement Pucks for 7075	15.99	CE-9



For Drums

Style	Application	Jobber	Order No.
Rubber Strap	Automobiles 5'L x 2 1/8"W x 1/8" thick	\$17.99	CE-1
	Trucks 6'6"L x 2 1/8"W x 1/8" thick	27.99	CE-2

1" Arbor for Ammco

- Fits Ammco models 2002, 3000, 4000, 4100, 7000, 7500 and 7700
- 7/8" x 9 LH thread
- Precision ground between centers using only one set-up for the greatest accuracy
- Factory checked for run-out of less than .001"
- Heat treated, stress relieved tool steel
- For drums & rotors up to 125 lbs.
- Order No. **GT-3101** Jobber \$197.79

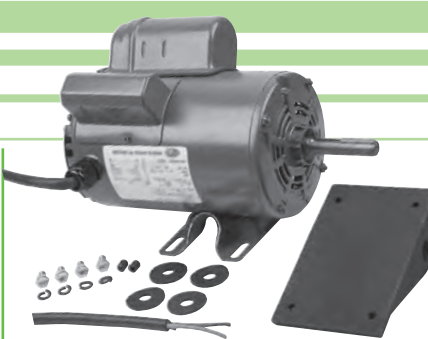

1HP Motor for Ammco Brake Lathes

- Fits 3000, 4000, 4100, 7000, 7500, & 7700 models
- 208 / 230 / 115V • 60Hz
- 1725 RPM
- Order No. **GT-2165** Jobber \$459.99



Right Angle Drive Assembly for Ammco Brake Lathes

- Fits 3000 & 4000 lathes
- Eliminates radial & axial play
- Order No. **GT-9815** Jobber \$359.99



GT-3102



GT-20442N



GT-3110

1" Arbor Accessories

Description	Model(s)	Thread	Jobber	Order No.
Arbor Nuts	Fits all Ammco but 1101	7/8" x 9 LH	\$21.99	GT-3102
	All arbors but Ammco	1" x 8 LH	18.99	GT-20442N
Centering Spring			5.29	GT-3110
1" Spacers for ALL Brake Lathes		Length	Jobber	Order No.
		1/2"	\$ 5.49	GT-3125
		Flexible	37.99	GT-9492



Replacement Work Light

- 30" adjustable arm
- 5/8" round mounting end
- Uses up to 100W standard base bulb (not included)
- Easily accessible switch
- Fits most Ammco models
- Order No. **GT-7963** Jobber \$92.99

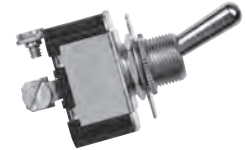

Replacement Switch for Ammco Brake Lathes

- Easy to install
- Fits most models
- Order No. **GT-7893** Jobber \$13.79



GT-10868



GT-10868X



GT-4670

Ammco Rotor & Drum Feed Screws & Bushings

Description	Jobber	Order No.
Rotor Feed Bushing (early)	\$ 28.99	GT-10868
Rotor Feed Bushing (late)	28.99	GT-10868X
Drum Feed Bushing (all)	49.99	GT-4670



GT-11227



GT-25913

GT-3031

GT-3165

Tooling Hold Down Pieces For Ammco

Description	Jobber	Order No.	Incl.
Stud Assembly	\$22.79	GT-25900	▼
6 1/2" Stud	6.79	GT-25913	x
Nut Assembly (must be used with 6 1/2" Stud)	23.99	GT-11227	x
5 1/2" Stud	6.79	GT-3031	
Washers (2)	13.49	GT-3165	



enlarged to show detail

Brass Wear Inserts For Ammco

Dia. x Lgth.	Jobber	Order No.
3/16" x 1/8"	\$1.99	GT-3141
1/64" x 1/4"	1.99	GT-3142
(most popular)		
1/4" x 1/64"	1.99	GT-9836



3163

3164

Replacement Seals For Ammco

Application	OD	Jobber	Order No.
Feed Screw	1.25"	\$6.99	3163
Spindle	3.55"	8.99	3164



Replacement Screw for Twin Cutter Tool Bit Holders

- Square Head Screw
- Order No. **GT-9249** Jobber \$1.99

Buy 5 or more (mix & match 7996 or 6854) and SAVE 10% off jobber!



Small Ammco Replacement Parts

Description	Jobber	Order No.
Locking Knob	\$2.99	6854
Cross Feed Shear Gear with C-Clip	5.99	7996

CYLINDER HEAD REBUILDING
CLEANING, ASSEMBLY & SAFETY
SHORT BLOCK REBUILDING
CRANKSHAFT/FLYWHEEL GRINDING
MISCELLANEOUS TOOLS & SUPPLIES
BRAKE SERVICE TOOLING
MEASURING
V-TWIN & METRIC HARD PARTS

CYLINDER HEAD REBUILDING
CLEANING, ASSEMBLY & SAFETY
SHORT BLOCK REBUILDING
CRANKSHAFT/ FLYWHEEL GRINDING
MISCELLANEOUS TOOLS & SUPPLIES
BRAKE SERVICE TOOLING
MEASURING TOOLS
HARD PARTS

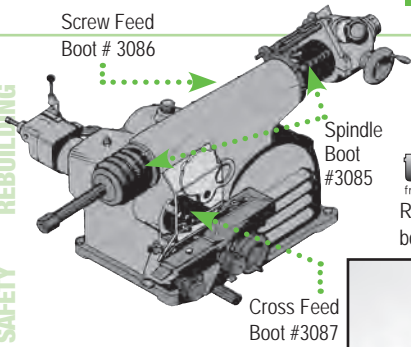

tech tips
from the techxperts™
Rubber is the standard boot material on most brake lathes



Replacement Boot Packs

- Keep extra boots on hand for routine maintenance or emergency replacement
- Fits Ammco 3000, 4000, 4100, 7000, 7700

Description	Jobber	Order No.	Incl.
Rubber Boot Pack	\$67.99	RSB-BOOT-PK	▼
Neoprene Spindle Boot Kit	44.99	SBR-KIT	▼
Rubber Spindle Boot Kit	47.99	RSB-KIT	▼
Rubber Spindle Boot	22.99	RSB-3085	x x
Neoprene Spindle Boot	21.29	3085	x
Screw Feed Dust Boot	12.99	3086	x
Cross Feed Dust Boot	16.49	3087	x
Boot Ring	23.99	23682	x x x
C-Clip	2.99	SBR-4435	x x x
Snap Ring	3.99	SBR-3159	x x x

Drive Pulleys & Belts for Ammco

- Fit Ammco 3000, 4000, 4100, 7000 & 7100
- Serpentine design runs quieter and increases arbor speed by 175RPMs
- Virtually eliminates vibration

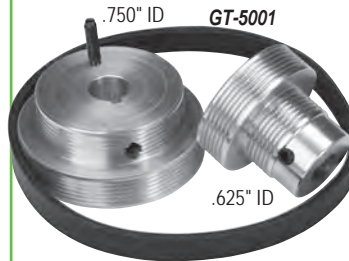

New-Style (Serpentine)

Description	Jobber	Order No.
Pulley Set (Includes 20 1/4" belt & 2 pulleys)	\$164.99	GT-5001
20 1/4" Belt	19.99	GT-5002
19" Belt	19.99	GT-5003

tech tips Install the drive pulley with the pin toward the right angle drive. The roll-pins drive against each other. A nylon sleeve prevents metal to metal contact.

Original-Style (V-belt)

Description	Jobber	Order No.
Drive Pulley (Motor)	\$64.99	GT-3024
Driven Pulley (Arbor with drive pin)	94.99	GT-7784-1
25" Belt (replaces OE 3161)	9.99	GT-3161
24" Belt (replaces OE 10241)	11.79	GT-10241

Don't buy a new brake lathe ... expand your existing one to handle rotors up to 15"

Lead Screw Bushing

- Easy installation
- Increases lathe capacity to 15"
- Ideal for machining large rotors common on SUVs and large pick-ups
- Fits Ammco 3000 and 4000 Brake Lathes
- Order No. **LSB-78529** Jobber \$29.99



See page 72 for more Flex-Hones®

Order 3 or more Flex-Hones® (mix & match) and save 10% off jobber



Brake Rotor Flex-Hones®

- Provide a non-directional finish
- Use with a 3/8" variable speed drill at 600-1000 RPM
- Zirconium abrasive
- Use dry

Type	Grit	Jobber	Order No.
Fine	240	\$51.99	BRF-25F
Medium	120	51.99	BRF-25M
Coarse	60	51.99	BRF-25C



Carbide Tipped Brake Drum Swedge Cutting Tool

- Hard-to-find tool cuts wheel stud swedges to remove and replace pressed-in wheel studs
- Use with a drill press or mill
- For 1/2" stud
- Order No. **ST-500** Jobber \$92.99

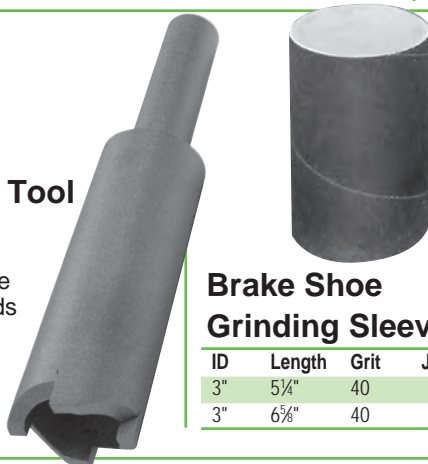

Brake Shoe Grinding Sleeves

ID	Length	Grit	Jobber	Order No.
3"	5 1/4"	40	\$5.99	AS-2
3"	6 5/8"	40	6.99	AS-4

Rotor & Drum Feed Screws & Nuts For FMC & Bean

Description	Jobber	Order No.
Rotor Feed Screw	\$41.99	GT-90071
Rotor Feed Nut	37.99	GT-90077

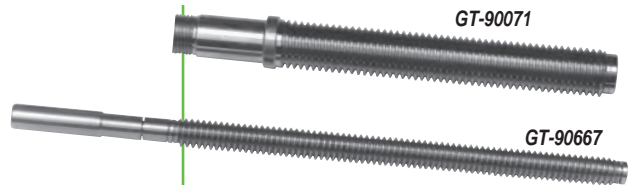



Brake Drum Grinding Wheels

- Aluminum-Oxide abrasive

For Van Norman / Reils 204, 300, 302, 303, 333 & 404 Drum Grinders

Size	OE No.	Shape	Jobber	Order No.
3" x 1/2" x 1"	8522	Recessed	\$19.99	GDV-304
3 1/2" x 1/2" x 1"	8931	Recessed	31.99	GDV-354
4" x 1/2" x 1"	8523	Recessed	32.99	GDV-404



Brake Drum Grinding Wheels

- Aluminum-Oxide abrasive

For Ammco 3050 and 5000 Drum Grinders

Size	OE No.	Shape	Jobber	Order No.
3" x 3/4" x 7/8"	5410	Recessed	\$16.99	GDA-205
4" x 3/4" x 7/8"	5405	Recessed	18.99	GDA-206

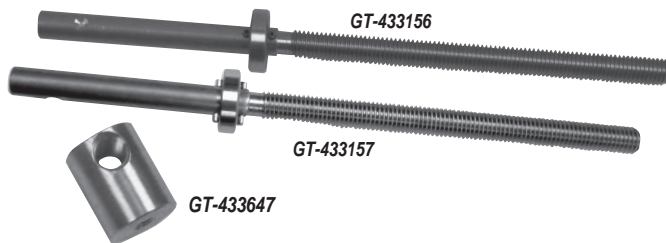

Assorted Accu-Turn Replacement Parts

Description	Jobber	Order No.
Rotor Feed Screw Assembly (1/2" 20TPI)	\$63.49	GT-433156
Drum Feed Screw Assembly (1/2" 13TPI)	63.49	GT-433157
Rotor Feed Bushing (fine thread)	32.99	GT-433647
Drum Feed Bushing (not shown) (coarse thread)	47.29	GT-433646

Replacement Motor for
Ammco Lathes on page 113

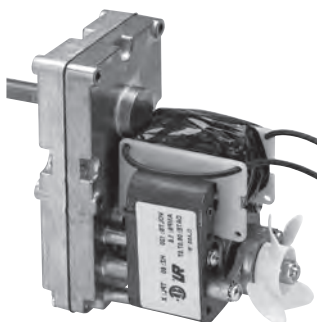

Replacement Feed Motor For Accu-Turn Brake Lathes

- For 7700, 8920, 8910, 8911, 8989, 8922 • 1/60 HP • 6 RPM
- 120V, 60Hz
- 1.5 Amps • Includes fan
- 2 year limited mfr. warranty
- Ships without blade attached to prevent damage
- Order No. **GT-3641** Jobber \$197.99

Brake Conditioning Spray

- Spray on rotors and drums to stop noise at the source
- OE approved spray-on metalizing treatment
- Effective from -100°F to +2000°F
- Prevents rust and seizure of lug nuts and threads
- Overspray won't damage calipers, rubber components or seals
- Aerosol*
- Order No. **BS-12*** Jobber \$17.99



* Hazardous Fees Apply When Shipped By Air



Pastelub™ Synthetic High Temp Brake Lubricant

- OE recommended
- High pressure resistant
- Recommended for the backs of brake pads
- Not for use on friction surfaces
- 2400°F Ultra high-temperatures range
- Patented "real synthetic" Swiss formula won't melt, rub off or wash off brake parts • Gray
- No silicone or petroleum to weaken the carrier base
- Order No. **BPL-2400** Jobber \$17.99



Ceramlub-2800™ Extreme High Temperature Lubricant

- Use on brake caliper slides, etc.
- Contains ceramic pressure solids and high concentrations of anti-corrosive agents
- Specifically designed for use on caliper slides, rubber seals and O-Rings
- A great complement to Pastelub™ Hi-Temp Lubricant
- Purple
- Order No. **CBL-2800** Jobber \$17.99



Buy a case of 12
(any combination BS-12,
BPL-2400, CBL-2800),
SAVE 10% off jobber



⚠ WARNING: Operating, servicing and maintaining a passenger vehicle or off-road vehicle can expose you to chemicals including engine exhaust, carbon monoxide, phthalates, and lead, which are known to the State of California to cause cancer and birth defects or other reproductive harm. To minimize exposure, avoid breathing exhaust, do not idle the engine except as necessary, service your vehicle in a well-ventilated area and wear gloves or wash your hands frequently when servicing your vehicle. For more information go to www.P65Warnings.ca.gov/products/passenger-vehicle.

CYLINDER HEAD REBUILDING
CLEANING, ASSEMBLY & SAFETY
SHORT BLOCK REBUILDING
FLYWHEEL GRINDING
CRANKSHAFT/ MISCELLANEOUS TOOLS & SUPPLIES
BRAKE SERVICE TOOLING
MEASURING TOOLS
V-TWIN & METRIC HARD PARTS



"We pride ourselves on getting orders to our customers quickly. We stock a wide variety of products so that we can get your order to you in 3 days or less."

- Brian, Goodson Receiving, 28 years of service

tech tips

from the techxperts™

When using bell clamps and centering cones always be sure they are clean and free of any dirt or rust.

Keep a light coating of oil on them to prevent rusting.

Never use a cone or a bell clamp for anything other than mounting a brake rotor or drum onto the brake lathe.

Always use the largest bell clamp that will fit the rotor or drum for the best support.

CYLINDER HEAD REBUILDING
CLEANING, ASSEMBLY & SAFETY
SHORT BLOCK REBUILDING
CRANKSHAFT/ FLYWHEEL GRINDING
MISCELLANEOUS TOOLS & SUPPLIES
BRAKE SERVICE TOOLING
MEASURING TOOLS
V-TWIN & METRIC HARD PARTS

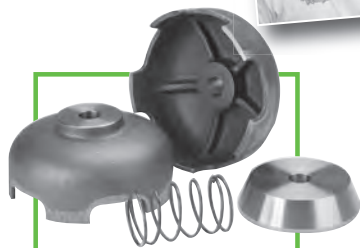

GT-5062

Buy individual pieces or save by buying the sets

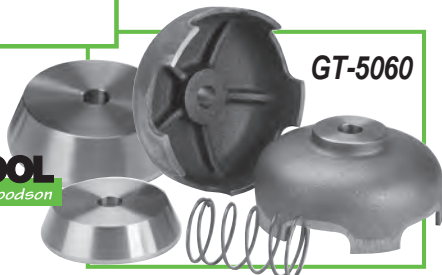

GT-5060

GOODTOOL
Now exclusively from Goodson

Truck Mounting Adaptor Sets For Brake Lathes With 1" Arbors

Description	Jobber	Order No.	Incl.
Standard Truck Set	\$284.99	GT-5062	▼
Master Truck Set	379.29	GT-5060	▼
Centering Cones	97.99	GT-5053	1 1
4.500" x 5.125"	81.79	GT-5052	
4.500" x 5.500"	104.79	GT-5054	1
5.000" x 6.125"	103.79	GT-5055	1 2
Bell Clamps	131.79	GT-5056	1
6.500" OD	9.99	GT-5059	1 1
7.750" OD			
Heavy-duty Spring	2.515" OD x 2.217" ID x 4" L		



Automotive Bell Clamps for Brake Lathes

OD Size:	4.500"
Arbor Size:	1.000"
Order No.:	GT-9490
Jobber:	\$39.99

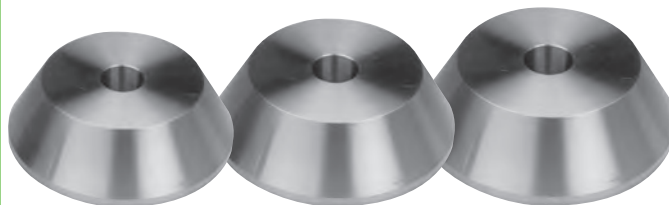

Automotive Single Taper Centering Cones for Brake Lathes

Range: 1.703" to 2.750"	Range: 2.328" to 2.986"	Range: 2.890" to 3.500"
Arbor Size: 1.000"	Arbor Size: 1.000"	Arbor Size: 1.000"
Order No.: GT-3904	Order No.: GT-3108	Order No.: GT-3107
Jobber: \$47.29	Jobber: \$42.99	Jobber: \$31.99

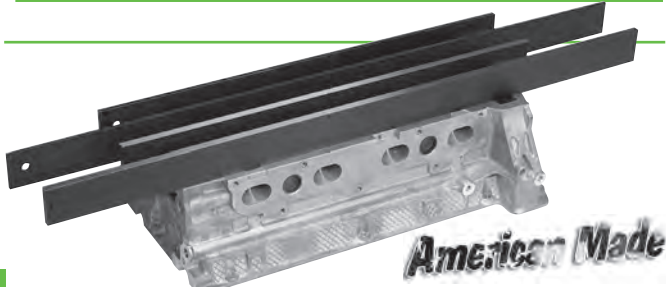

Precision Straight Edges & Warp Gauge

• Accuracy .0005" per foot

Description	Jobber	Order No.
24" straightedge, 1 precision edge	\$129.99	DIS-24
36" straightedge, 1 precision edge	149.99	DIS-36
24" straightedge, 2 precision edges	184.99	DIS-20
35" straightedge, 2 precision edges	207.99	DIS-30

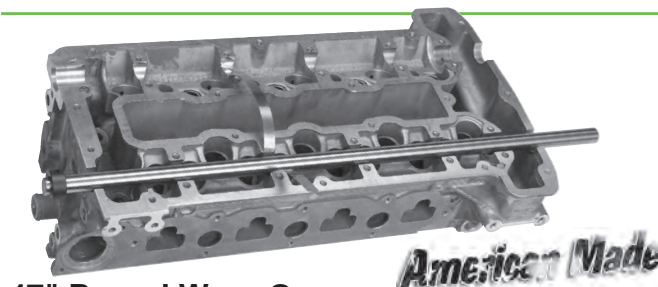

47" Round Warp Gauge

- Use with feeler gauges (below)
- 3/4" diameter tool steel
- Includes anti-roll collar and eye bolt allowing you to hang it for safe, convenient storage
- Order No. **EWG-100** Jobber \$159.99



12" Feeler Gauges

- Measure piston-to-wall clearance when honing, to find ring end gap and to check cylinder heads with a straight-edge
- Also useful for shimming while straightening heads and for machine set-ups

	Jobber	Order No.
Complete Kit	\$39.99	FE-KIT ▼
Thick .0015"	6.99	FE-0015 x
.0020"	6.99	FE-002 x
.0030"	6.99	FE-003 x
.0040"	6.99	FE-004 x
.0050"	6.99	FE-005 x
.0060"	6.99	FE-006 x
.0070"	6.99	FE-007 x
.0080"	6.99	FE-008 x
.0090"	6.99	FE-009 x
.0100"	6.99	FE-010 x
.0150"	6.99	FE-015 x
.0200"	6.99	FE-020 x



6 Piece Telescoping Gauge Set

- Compress spring plunger and lock by twisting handle
- Insert into bore and release plunger – it will expand to fit
 - Lock again and remove
 - Measure with a micrometer
 - Double plunger design for consistent measuring
 - Long-lasting finish
 - Size range: 5/16" - 6"
- Order No. **MTG-6** Jobber \$133.99



Build Your Own Valve Guide Gauge Set! Order the Valve Guide Gauge (P-300), Setting Fixture (P-610A) and the Valve Guide Probe you need.

Valve Guide Gauge Set

- The only way to be sure clearance is correct is to gauge it
- Checks all types of guides for size and roundness FAST
- Set up and measure valve guide IDs quickly and easily
- Complete set includes gauge, 3 probes (.312", .344" and .375"), hex wrench, setting fixture and metal storage case with spaces for all components
- Dial calibrated in .0002" increments

Description	Jobber	Order No.	Incl.
Complete Valve Guide Gauge Set	\$2027.52	P-310	▼
Valve Guide Gauge	608.26	P-300	x
Setting Fixture	601.72	P-610A	x

Valve Guide Probes					
Size	Range in.	mm			
.236"	.244" to .264"	5.69 to 6.71	\$350.56	P-236	
.250"	.238" to .278"	6.05 to 7.05	363.64	P-250	
.281"	.269" to .309"	6.83 to 7.85	376.72	P-281	
.312"	.300" to .340"	7.62 to 8.64	389.80	P-312	x
.344"	.332" to .372"	8.43 to 9.45	402.88	P-344	x
.375"	.363" to .403"	9.22 to 10.24	415.96	P-375	x
.406"	.394" to .434"	10.01 to 11.02	429.04	P-406	
.438"	.426" to .466"	10.82 to 11.84	442.12	P-438	
.469"	.457" to .497"	11.61 to 12.62	455.21	P-469	
.500"	.488" to .528"	12.40 to 13.41	468.29	P-500	

Mitutoyo

Split Ball Bore Gauge

- Dial gauge with large contact area
- Measures quickly & accurately to .0001"
- Works in threaded or knurled guide IDs
- Range: .280"-.400" • Easy to change contacts
- Order No. **MVG-34** Jobber \$629.99



Sunnen® AG-Series Precision Gauge

- Dial reads directly in "tenths" (.0001")
- Checks rod journal bore for distortion
- Measures size instantly
- Wear-compensated gauge points for permanent accuracy
- Rugged construction – all moving parts are enclosed in the housing
- Includes Point Sets listed below (optional point sets are available, call for information)

Description	Jobber	Order No.
.375" - 3.375" (9.5 - 85.7mm) Range Gauge	\$3594.95	AG-300
Standard Point Set (.720" - 1.530" Range)	53.63	AG-210
Medium Point Set (1.50" - 2.25" Range)	81.76	AG-620
Large Point Set (1.932" - 2.687" Range)	81.76	AG-630
Sun-Dura® Gauge Cover (8"L x 8"H x 4"D)	36.99	GMC-AG-300

Point sets will NOT fit AG-gauges lower than Serial No. 4000

Rod Bolt Stretch Gauge

- Accurate to .001"
- Features a 1½" dial gauge
- Heavy-duty tension spring for repeatable accuracy
- For bolts from 1" to 2½" long

Description	Jobber	Order No.
Rod Bolt Stretch Gauge	\$79.99	RBSG-3
Optional Contact Point	11.99	ERBG-3T

tech tips

from the techxperts™

Most engine rod failures aren't from faulty parts, they're from improper installation.

When you're installing the rods, you need to check the rod bolt stretch by performing a series of torquing and loosening and recording the readings.

Here's how:

1. Torque the bolts to 15 foot pounds and measure the stretch. Record the reading, then loosen the bolts.
2. Repeat at 15 foot pounds and record the reading.
3. Repeat, increasing to 30 foot pounds, record the reading.
4. Repeat, increasing to 60 foot pounds, record the reading.
5. Repeat at 60 foot pounds and record the reading.

Each time you loosen the bolts, measure to be sure that the rod bolts have returned to within .001" of the starting size. If you have a greater variation, get rid of the rod bolts and start with new ones.

When you're conducting final assembly, be sure you use the stretch specified by your rod manufacturer. Attach a rod bolt stretch gauge to the connecting rod bolt and zero it. Use an extra-long box wrench to tighten until the proper stretch is achieved.



CYLINDER HEAD REBUILDING
ASSEMBLY & SAFETY
CLEANING, REBUILDING
SHORT BLOCK REBUILDING
FLYWHEEL GRINDING
CRANKSHAFT/ TOOLS & SUPPLIES
MISCELLANEOUS
BRAKE SERVICE
MEASURING TOOLS
V-TWIN & METRIC HARD PARTS

American Made

Dial Bore Gauge Setting Fixture

- Fast, accurate setting from 2" to 6"
- Billet steel construction with a tool black finish
- Sets most popular bore gauges including Mitutoyo, Phase II, Fowler and Peacock • Will not fit Sunnen® Bore Gauges (see page 119 for Sunnen setting fixture)
- .001" increment micrometer • 3 setting standards (1", 2" & 3") included • Carrying case included
- Order No. **DBG-FIX** Jobber \$499.99

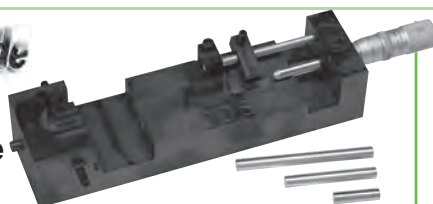

Cylinder Dial Bore Gauge Sets

- Easy to read • Insulated grip
- Measure cylinders up to 9" deep
- Graduations: .0005" • Self-centering
- Chrome plated handle
- Includes extension holder and fitted case



Range	Jobber	Order No.
0.7" - 1.4"	\$144.99	FBG-7
1.4" - 6.0"	175.99	FBG-146



Dial Bore Gauge Set

- Rugged bore gauge with protected dial
- Carbide tipped contact points
- .0001" (.001mm) graduations • Indication stability: .00008"
- Accuracy: .0002" • Shoe can be rotated for a fresh wear surface • Sets up with a standard micrometer (see page 120) or **DBG-FIX** (pictured above)

Range	Description	Jobber	Order No.
2.0"-6.0"	11 anvils and 4 spacers	\$549.99	MNCB-06
	Replacement Spacers for anvils 2" & larger	9.99	MNCB-06-020
	.020"	9.99	MNCB-06-040
	.040"	9.99	MNCB-06-080
	.080"	9.99	MNCB-06-120
	.120"	9.99	MNCB-06-120
	Replacement Lens	21.99	MNCB-06LENS
	Replacement Dial Indicator	209.99	MNCB-06IND
	Replacement Dial Cover	27.99	MNCB-06COVER

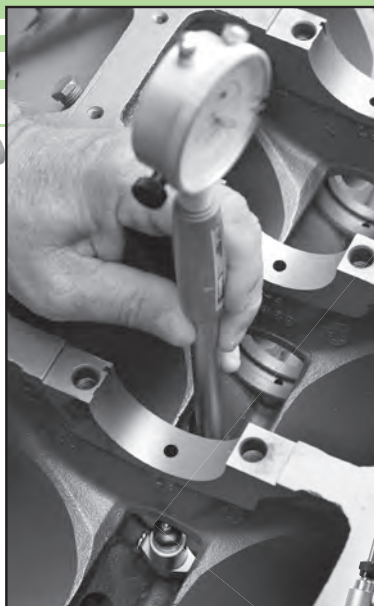

90° Dial Bore Gauges

- Measure cam bores, main bores and other hard-to-reach areas directly
- No passing through other bores to measure inboard journals • .100" travel in .0001" increments
- Metric has 3mm travel in .01mm resolution
- 3 spacers, 11 probes and case included



Range	Graduations	Jobber	Order No.
2.0" - 6.0"	.0001" / .0025mm	\$379.99	MCB-90
50-160mm	.01mm	227.99	DMBG-50160

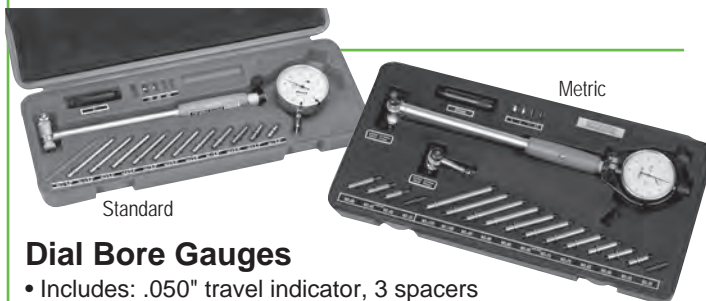

Dial Bore Gauges

- Includes: .050" travel indicator, 3 spacers (.100", .050" and .020"), probes and case

Description	Range	Probes	Resolution	Jobber	Order No.
Standard US	2" - 6"	11	.0005"	\$159.99	EBG-265
Standard US	2" - 6"	11	.0001"	249.99	EBG-261
Metric	35 - 160mm	12	.01mm	182.99	MCBG-160
11 Pc. Replacement Spacer Set				36.99	EBG-ANVILS



Internal Electronic Caliper

- Ideal for measuring mating port runners and bowl diameters
- Hardened contact surfaces
- Robust housing with large LCD display
- Range: 0.5" to 6.0" • Reading: .01" (.3mm) / 1/64th
- Spring loaded locking nut
- Order No. **IEC-56** Jobber \$54.99

Sunnen® Dial Bore Gauges



Sunnen® Dial Bore Gauges

- Standard Sunnen® Dial Bore Gauges read out in tenths
- Also available in five-tenths and metric (special order)
- Diameter ranges from .495" to 6.000" (see chart for gauge ranges)
- All models below feature all-carbide gauging points, wear-proof ball crank and adjustable centralizers
- Include molded storage case with all tools and wrenches required for setup and adjustment

Shock-Shield protects dial from hand heat and jarring to assure accurate reliable readings.

All standard Sunnen Dial Bore Gauges are TENTH READING. Metric and .0005" readouts are also available (special order). Dial can be indexed 90° for easy reading at any angle.

Adjustable centralizers for proper centering over the entire diameter range. One twist adjusts gauge tension so head goes into and out of any size hole smoothly.

Patented wear-proof ball crank assures repeatability over a long life.

Carbide indicating points are long wearing and replaceable.

Transfer Rod

Indexable Centralizer Points

GA-4141

- Measures to within .200" of the bottom of a blind bore
- Carbide balls replaceable in the indicating fingers only
- Set with SCF-502 Setting Fixture
- Non-retractable gauge

GR-6241

- Measures to within .270" of the bottom of a blind bore
- Carbide balls replaceable in the indicating fingers only
- Set with SCF-502 Setting Fixture
- Retractable gauge

GR-9241

- Measures to within .335" of the bottom of a blind bore
- Carbide balls replaceable in indicating fingers and extension points
- Set with SCF-502 Setting Fixture
- Retractable gauge

GA-2121 / GA-2125

- Measures to within .500" of the bottom of a blind bore
- Carbide balls replaceable in indicating fingers and extension points • Use CF-1126 Setting Fixture
- Non-retractable gauge

GR-2121/ GR-2241 / GR-2245

Diameter Range		Max Gauging Depth		Overall Length		.0001" Reading		.0005" Reading	
in	mm	in	mm	in	mm	Jobber	Order No.	Jobber	Order No.
.495" to .750"	12.6 to 19.0	7.00"	175	11.8125"	302	\$1091.55	GA-4141	_____	_____
.740" to 1.19"	18.9 to 30.2	12.00"	300	17.6875"	451	1242.68	GR-6241	_____	_____
1.18" to 2.00"	30.0 to 50.8	12.00"	300	17.75"	452	1242.68	GR-9241	_____	_____
2.00" to 6.00"	50.0 to 150.0	12.00"	300	17.00"	432	1131.73	GA-2121	\$1098.79	GA-2125
2.00" to 6.00"	50.0 to 150.0	12.00"	300	17.00"	432	1381.02	GR-2121	_____	_____
2.00" to 6.00"	50.0 to 150.0	24.00"	600	29.00"	737	1340.78	GR-2241	1314.62	GR-2245

Small Diameter Dial Bore Gauge & Accessories

- Dial Bore Gauge assembly consists of .0001" (.002mm) reading indicator, probe retractor and probe retainer bushing in a reinforced nylon insulating shroud
- Dial Bore Gauge diameter range: 0.054" to 0.535" (1.37 to 13.6mm)

Description	Jobber	Order No.
1-Small Diameter Dial Bore Gauge	\$ 948.36	GR-3000
2-Adjustable Probes		
	Range in	mm
	.165" to .189"	5.69 to 6.71
	.185" to .209"	6.05 to 7.05
	.205" to .228"	6.83 to 7.85
	.224" to .248"	7.62 to 8.64
	.244" to .268"	8.43 to 9.45
	.264" to .287"	9.22 to 10.24
	.283" to .307"	10.01 to 11.02
	.303" to .327"	10.82 to 11.84
	.323" to .346"	11.61 to 12.62
	.343" to .366"	12.40 to 13.41
	.362" to .386"	12.40 to 13.41
3-Transfer Pin (fits all probes above)	146.51	G-2264
4-Probe Extension	173.97	KZIX-3500

How to Order:

- 1 - Gauge
- 2 - Probe
- 3 - Transfer Pin
- 4 - Probe Extension

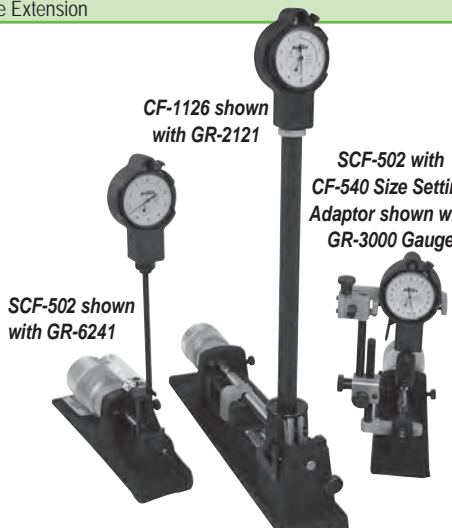

Dial Bore Gauge Setting Fixtures

- Models combine to cover a continuous range of .054" to 8" in .0001" increments
- Heavy stress-relieved cast iron bases
- Lapped carbide micrometer anvils
- Built-in magnifier
- Each setting fixture includes a master calibrating ring
- Size Setting Adaptor centers gauge probes between parallel reference surfaces on SCF-502 Setting Fixture

Range	Jobber	Order No.
.054" to 2.00"	\$1994.82	SCF-502
Size Setting Adaptor	877.73	CF-540
2.00" to 8.00"	1981.74	CF-1126

Gauges & Setting Fixtures Sold Separately

CYLINDER HEAD REBUILDING
 ASSEMBLY & SAFETY
 CLEANING, REBUILDING
 SHORT BLOCK REBUILDING
 CRANKSHAFT/FLYWHEEL GRINDING
 MISCELLANEOUS TOOLS & SUPPLIES
 BRAKE SERVICE TOOLING
 MEASURING TOOLS
 V-TWIN & METRIC HARD PARTS

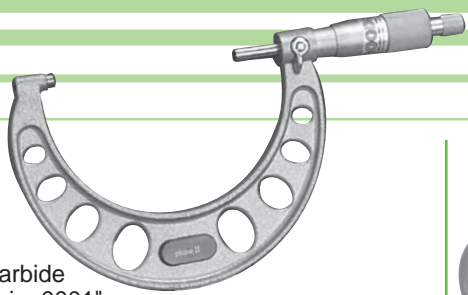

Premium Micrometers

- Precision ground carbide anvil parallel to within .0001"
- .0001" graduations • Set includes wood storage case

Description	Range	Jobber	Order No.	Incl.
Micrometer Set	(wood storage case)	\$279.99	EMS-06	▼
Individual Micrometers	0"-1"	39.99	EMIC-01	x
	1"-2"	43.99	EMIC-12	x
Each Micrometer	2"-3"	49.99	EMIC-23	x
includes a Standard,	3"-4"	52.99	EMIC-34	x
Spanner Wrench & Case	4"-5"	62.99	EMIC-45	x
	5"-6"	64.99	EMIC-56	x

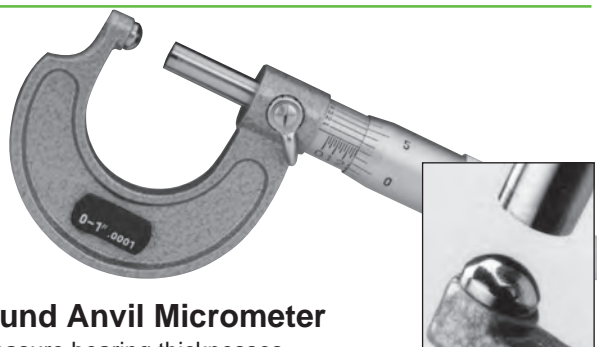

Round Anvil Micrometer

- Measure bearing thicknesses
- Ratchet spindle • 0-1" range • Precise to .0001"
- Order No **MIC-01-B** Jobber \$109.99

Checking Standards

- Use to set up dial indicators in special application gauging and to check micrometer accuracy
- Made of hardened, ground and lapped tool-steel
- Meet or exceed federal accuracy specifications

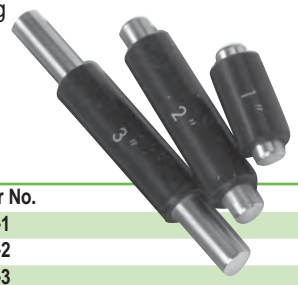

Length	Jobber	Order No.
1"	\$11.99	MCS-1
2"	12.99	MCS-2
3"	13.99	MCS-3

Mitutoyo

Small Hole Gauge Set

- See if rebuilding or replacement is needed by checking actual guide wear
- Check guide bosses for proper interference fit during replacement
- Check and maintain correct stem to guide ID clearance
- 4-piece set has combined range of .125"-.500" / 3.2-12.7mm
- Storage case included
- Order No. **SHG-5** Jobber \$139.99



Open and close the padded jaws to accommodate most micrometers and dial bore gauges



Easy to reach knob adjusts the head angle

Micrometer Stand

- Heavy cast iron construction
- Use to hold micrometers, standards or just about anything you need an extra hand for
- Swivel head and padded jaws won't damage expensive measuring tools
- Order No. **MIC-FIX** Jobber \$22.99



Use the Micrometer Stand When Setting Your Dial Bore Gauge

Read more about it on our blog at www.goodson.com. Search for Dial Bore Gauge





MBR-1

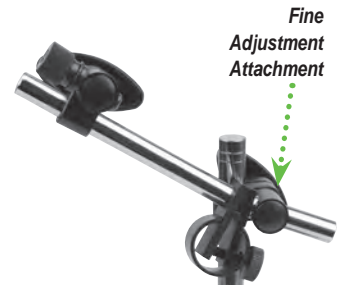

Fine Adjustment Attachment

MBR-1F

Universal Magnetic Base Holders

- Fit any type of dial indicator
- Magnetic base features an on-off switch with magnetic pull of 90 pounds
- 3/8" diameter 7" high vertical column
- 2" x 2 1/2" x 2 1/4" base
- Available with or without Fine Adjustment Feature

Description	Jobber	Order No.
Universal Holder	\$39.99	MBR-1
With Fine Adjustment	41.99	MBR-1F

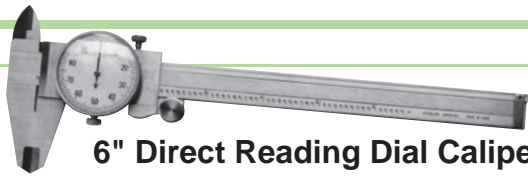

6" Direct Reading Dial Caliper

- Four way measurement - outside, inside, depth and step
- Hardened stainless steel with satin chrome finish
- Precision ground and lapped measuring surfaces
- Reads direct to .001" or with .100" graduations on beam
- Adjustable bezel with lock
- Thumb roll with lock
- 1 $\frac{1}{8}$ " jaw length
- Large easy to read dial
- Covered rack • Deluxe fitted case
- Order No. **MDC-03** Jobber \$74.99



12" Direct Reading Dial Caliper

- .001" single revolution • Hardened measuring face
- Precision Ground • Micro-lapped for accuracy
- Adjusting slide for fine adjustment
- Take Inside, Outside and Depth measurements
- Satin Chrome finish with engraved graduations
- Clamp for repetitive readings
- Accurate to .001" per 6"
- Covered Rack • Deluxe fitted case
- Order No. **EDC-12** Jobber \$119.99

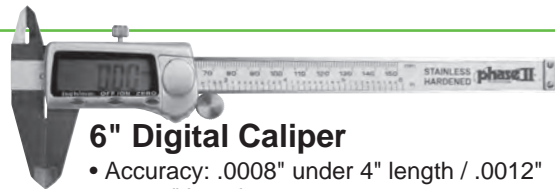

6" Digital Caliper

- Accuracy: .0008" under 4" length / .0012" over 4" length
- .0005" (.01mm) resolution
- Automatic floating zero
- Used to take Inside and Outside measurements
- Direct inch/metric Conversion
- Large, high-contrast LCD display
- On/Off Button • Deluxe fitted case

Description	Jobber	Order No.
Digital Caliper	\$62.99	EEDC-06
Replacement Battery	5.99	EDC-06B

Mounts on Your Pilot

Valve Seat Height Gauge

Includes Dial Indicator

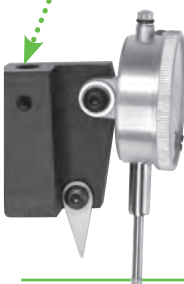

- Confirm seat height to fire deck location
- Adjusts for all popular seat diameters
- Accurate to .001"
- Seat contact probe aligns on valve seat while gauge rides along the fire deck
- Pilot aligns in valve guide (pilot sold separately)
- Adjustable to fit popular seat diameters from .750" to 3.00"

Description	Fits Pilot	Jobber	Order No.
Valve Seat Height Gauge Kit	.375"	\$94.99	VSHG-375
Replacement Dial Indicator		28.99	EDI-1

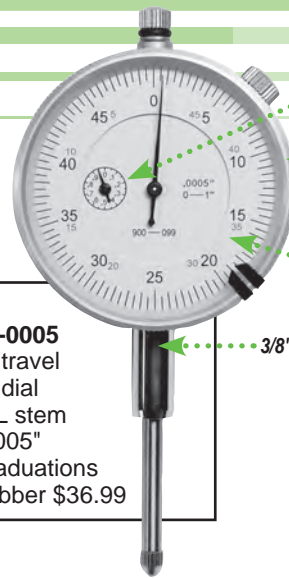

Revolution Counter (included on most models)

Adjustable bezel for zero settings

Shatter resistant crystal

3/8" stem

- EDI-0005**
- 1" travel
 - 2" dial
 - 1"L stem
 - .0005" graduations
 - Jobber \$36.99

All Indicators have lug back



EDI-1

- 1" travel • 2" dial
- 1"L stem
- .001" graduations
- Jobber \$28.99



MDI-2

- 2" travel • 3" dial
- 2"L stem
- .001" graduations
- Jobber \$67.99



MDI-12

- .125" travel
- 2" dial
- 12"L stem
- .001" graduations
- Jobber \$399.99



Starrett

Dial indicators sold separately



Deck Bridge Tools

- Verify deck height without removing block from roll over fixture
- Flat anvil surface makes full contact
- Use Deck Bridge with either 1 or 2 dial indicators • Designed for multiple set-ups

Description	Jobber	Order No.
Deck Bridge (4 $\frac{1}{2}$ " span)	\$ 87.99	MDBS-2
Dial Indicator (12" OAL)	399.99	MDI-12
Dial Indicator Flat Anvil	29.99	MDI-12A
Economy Dial Indicator	28.99	EDI-1

• MDI-12A

CYLINDER HEAD REBUILDING
CLEANING, ASSEMBLY & SAFETY
SHORT BLOCK REBUILDING
CRANKSHAFT/GRINDING TOOLS & SUPPLIES
MISCELLANEOUS TOOLING
BRAKE SERVICE
MEASURING TOOLS
V-TWIN & METRIC HARD PARTS



Black Diamond™ Replacement Valves for Milwaukee-Eight™ Heads

- Black Nitroleg Stems
- One-piece forged stainless steel valves impregnated by a special German process to improve wear properties and reduce friction
- Provide resistance to corrosion and wear superior to hard chromium and electrolysis nickel plating

Type	Head Diameter	Stem Dia.	Radius	Tulip Angle	Overall Length	MSRP	Jobber	Black Diamond™ Triple Groove
Intake	1.571" (39.90mm)	0.2347"	0.235"	10°	4.015"	\$37.55	\$25.90	20-21012
Intake	1.591" (40.40mm)	0.2347"	0.235"	10°	4.015"	37.55	25.90	20-21015
Intake	1.630" (41.40mm)	0.2347"	0.235"	10°	4.055"	37.55	25.90	20-21013
Exhaust	1.264" (32.11mm)	0.2342"	0.460"	24°	4.050"	37.55	25.90	20-21016
Exhaust	1.284" (32.61mm)	0.2342"	0.460"	24°	4.050"	37.55	25.90	20-21017

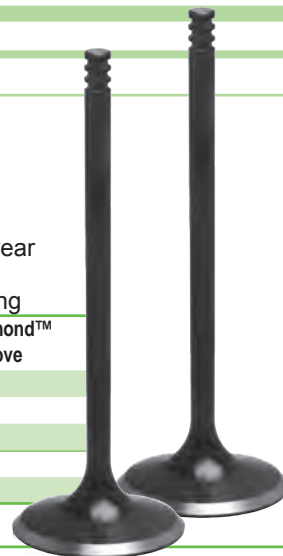

Milwaukee-Eight™ Tophat Valve Seal

- Designed to fit Milwaukee-Eight™ Valve Guides
- 6.0mm Stem Diameter
- 0.712" Overall Length • 1.170" Seal OD
- For intake and exhaust • 16 pack
- Order No. **71046-16**
- MSRP \$23.05 | **Jobber \$16.12**



Milwaukee-Eight™ Replacement Keepers

- Fits 7° x 0.236" Stem
- Triple Radius Bead
- 8 pairs per package
- Order No. **51029-8**
- MSRP \$66.61 | **Jobber \$45.94**

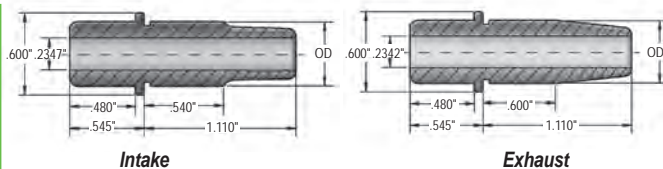

Milwaukee-Eight™ Manganese Bronze Valve Guides

- Use with 6mm seals (71046 or OE)

Intake				Manganese Bronze	Cast Iron
OD	ID	OAL	Size		
.4750"	.545"	1.655"	Std.	20-21020M	20-21020C
.4760"			+ .001"	20-21021M	20-21021C
.4770"			+ .002"	20-21022M	20-21022C
.4850"			+ .010"	20-21029M	20-21029C
Exhaust				Manganese Bronze	Cast Iron
OD	ID	OAL	Size		
.4750"	.545"	1.655"	Std.	20-21030M	20-21030C
.4760"			+ .001"	20-21031M	20-21031C
.4770"			+ .002"	20-21032M	20-21032C
.4850"			+ .010"	20-21039M	20-21039C
MSRP				\$13.12	\$8.83
Jobber				\$9.05	\$6.09

Milwaukee-Eight™ Beehive Valve Spring Kits

- Advanced spring design with special attention to cam and spring harmonics, stress, mass and operating RPM
- Premium-grade, super clean ground chrome silicon wire • Heat-treated and shot peened for long life



.465" Max Lift Beehive Valve Spring Kit With Titanium Retainers

- Includes 8 retainers, 8 springs and 8 base washers
- Installed Height: 1.410"
- Seat Pressure: 80 lbs.
- Open Pressure: 212 lbs. at .465"
- Order No. **20-21000**
- MSRP: \$313.38 | **Jobber: \$216.12**

.465" Max Lift Beehive Valve Spring Kit With Heat Treated Steel Retainers

- Includes 8 retainers, 8 springs and 8 base washers
- Installed Height: 1.410"
- Seat Pressure: 80 lbs.
- Open Pressure: 212 lbs. at .465"
- Order No. **20-21050**
- MSRP: \$250.70 | **Jobber: \$172.90**

.550" Max Lift Beehive Valve Spring Kit With Titanium Retainers

- Includes 8 retainers, 8 springs
- Use with OE seals or Milwaukee Eight™ Tophat Valve Seals (above)
- Installed Height: 1.550"
- Seat Pressure: 104 lbs.
- Open Pressure: 230 lbs. at .550"
- Order No. **20-21200**
- MSRP: \$398.05 | **Jobber: \$274.51**

MEASURING TOOLS
 BRAKE SERVICE TOOLING
 MISCELLANEOUS TOOLS & SUPPLIES
 CRANKSHAFT/ FLYWHEEL GRINDING
 SHORT BLOCK REBUILDING
 CLEANING, ASSEMBLY & SAFETY
 CYLINDER HEAD REBUILDING
 V-TWIN & METRIC HARD PARTS



Solid Viton Seals With Metal Jacket & Choker Spring

• 16 Per Package

Stem Dia.	OAL	Seal OD	A	B	C	MSRP	Jobber	Order No.
7.0mm	0.510"	0.665"	0.560"	—	0.375"	\$50.25	\$34.66	71028
.312"	0.412"	0.566"	0.420"	—	0.275"	25.73	17.79	71010
.312"	0.514"	0.671"	0.530"	—	0.330"	50.25	34.66	71045
.375"	0.516"	0.661"	0.562"	—	0.210"	29.37	20.26	71011

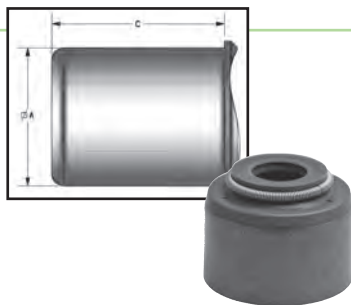

Solid Viton Seals With Metal Jacket & Integral Spring Base

• 16 Per Package
• Spring Shoulder Diameter: 0.970"

Stem Dia.	OAL	Seal OD	A	B	C	MSRP	Jobber	Order No.
7.0mm	0.974"	1.457"	0.560"	—	0.700"	\$36.94	\$25.48	71030

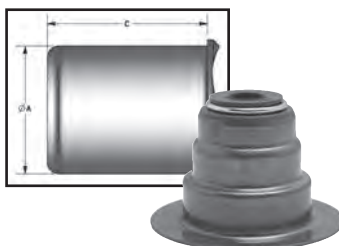

OE Style Seals Solid Teflon With Metal Jacket

16 Per Package

Stem Dia.	OAL	Seal OD	A	D	MSRP	Jobber	Order No.
.312"	0.385"	0.565"	0.420"	0.315"	\$29.37	\$20.26	71032
.312"	0.375"	0.630"	0.530"	0.295"	29.37	20.26	71033
.343"	0.375"	0.630"	0.530"	0.365"	29.37	20.26	71034
.375"	0.375"	0.660"	0.562"	0.315"	29.37	20.26	71035
.375"	0.400"	0.720"	0.625"	0.310"	29.37	20.26	71036



6061-T6 Aluminum Seal Drivers

These installation tools for OE style seals are manufactured from high strength 6061-T6 Aluminum for increased durability when compared to plastic installers.

Application	Color	Fits Seal Up To	Order No.
Evolution	Red	0.575"	20-20830
Pan/Shovelhead 74"	Black	0.673"	20-20833
Ironhead Sportster	White	0.638"	20-20832
Shovelhead 80"	Blue	0.728"	20-20831
MSRP: \$7.27		Jobber \$5.02	

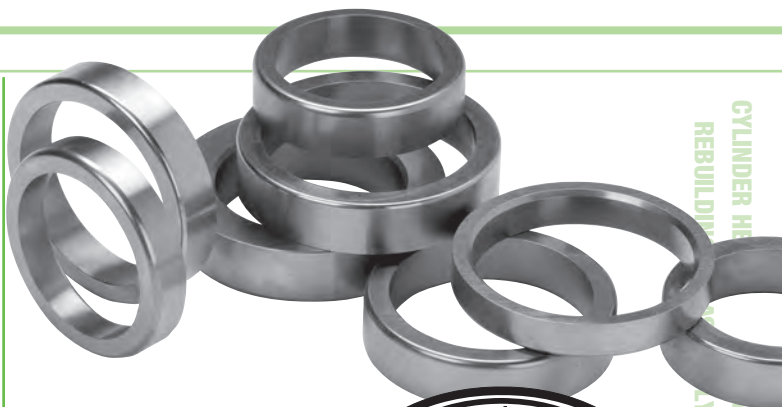

Valve Seat Inserts

- For Harley-Davidson®
- Easy to machine
- Effectively dissipate heat for consistent valve sealing
- Hardness increases during engine break-in
- Radiused for easy installation



Replacement Valve Seats For Shovel Head 1200 & 1340

Application	OD	ID	Thickness	MSRP	Jobber	Order No.
Exhaust	1.944"	1.575"	.400"	\$10.12	\$6.99	10-HC493
Intake	2.135"	1.750"	.400"	10.12	6.99	10-HC542

Oversize Seats For Shovel, Evolution & Twin Cam – machining required

OD	ID	Thickness	MSRP	Jobber	Order No.
1.630"	1.180"	.385"	\$10.12	\$6.99	10-HC414
1.757"	1.410"	.430"	10.12	6.99	10-HC447
1.882"	1.530"	.410"	10.12	6.99	10-HC478
2.008"	1.610"	.440"	10.12	6.99	10-HC510
2.040"	1.700"	.425"	10.12	6.99	10-HC518
2.070"	1.610"	.460"	10.12	6.99	10-HC526
2.132"	1.800"	.460"	10.12	6.99	10-HC541
2.163"	1.750"	.455"	10.12	6.99	10-HC549

For Iron Head Sportster

Application	OD	ID	Thickness	MSRP	Jobber	Order No.
Exhaust	1.757"	1.371"	.315"	\$10.12	\$6.99	10-HC446
Intake	2.068"	1.750"	.315"	10.12	6.99	10-HC525

Universal Repair Seat

OD	ID	Thickness	MSRP	Jobber	Order No.
1.339"	1.024"	.375"	\$10.12	\$6.99	10-SC340
1.693"	1.299"	.434"	10.12	6.99	10-SC430
1.820"	1.375"	.450"	10.12	6.99	10-HC462
1.945"	1.375"	.440"	10.12	6.99	10-HC494
2.257"	1.550"	.500"	10.12	6.99	10-HC573

Nickel Chrome Valve Seats on Page 14

tech tips When installing seats preheat head to 400° and freeze the seat for easier installation. Press fit .006" to .008".

.421" Valve Seal Cutter

- Evo/Twin Cam
- Will shorten and re-chamfer the guide top, increasing seal-to-retainer clearance for higher lift camshafts
- Can also be used to modify .530" guides to .421" guides
- Guide OD: .421" • Pilot Size: .312"
- Use with HVS-421 seal (above)
- Order No. **VSC-420312**
Jobber \$97.29



"Absolutely amazing! You have to have the most courteous and friendly people working there. Always a pleasure to order from Goodson. A lot of companies could learn from your staff. To top it off, the supplies are top notch and ship very quickly."
- Dan Degenhardt, Degenhardt Garage, Coon Valley, WI, Goodson Customer since 1999



Guide Driver for Reduced Diameter Top Valve Guides

The guide top fits into the groove between the driver and the bushing to center and drive the guide into place. Puts pressure on the step top of the guide, not the seal area. Required for installing 20-2120 & 20-2130 series guides (below).
Order No. **VGD-315420** Jobber \$42.99

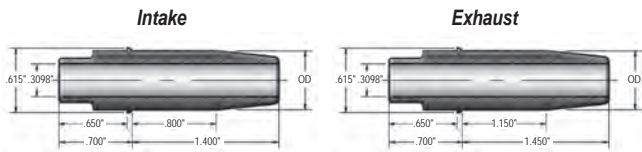

Evolution, Twin-Cam & Evo Sportster With 5/16" Valves

• Use with 71010 Viton Seals or 71032 OE Style Seals

Intake				Manganese Cast		
OD	ID	OAL	Size	Bronze	Iron	Replaces
.5620"	.3098"	2.100"	Std.	20-2120M	20-2120C	
.5630"			+ .001"	20-2121M	20-2121C	HVG-5600S
.5640"			+ .002"	20-2122M	20-2122C	HVG-5601S
.5720"			+ .010"	20-2129M	20-2129C	

Exhaust				Manganese Cast		
OD	ID	OAL	Size	Bronze	Iron	Replaces
.5620"	.3098"	2.150"	Std.	20-2130M	20-2130C	
.5630"			+ .001"	20-2131M	20-2131C	HVG-5700S
.5640"			+ .002"	20-2132M	20-2132C	HVG-5701S
.5720"			+ .010"	20-2139M	20-2139C	

MSRP		\$13.12	\$8.83
Jobber		\$9.05	\$6.09

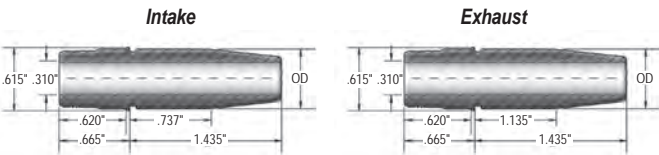

Evolution, Twin-Cam & Evo Sportster With 5/16" Valves

• Use with 71045 Viton Seals

Intake				Manganese Cast		
OD	ID	OAL	Size	Bronze	Iron	Replaces
.5625"	.3100"	2.100"	Std.	20-20860M	—	HVG-5600
.5635"			+ .001"	20-20861M	—	HVG-5601
.5645"			+ .002"	20-20862M	—	HVG-5602
.5725"			+ .010"	20-20869M	—	

Exhaust				Manganese Cast		
OD	ID	OAL	Size	Bronze	Iron	Replaces
.5625"	.3096"	2.100"	Std.	20-20870M	—	HVG-5700
.5635"			+ .001"	20-20871M	—	HVG-5701
.5645"			+ .002"	20-20872M	—	HVG-5702
.5725"			+ .010"	20-20879M	—	

MSRP		\$13.12	\$8.83
Jobber		\$9.05	\$6.09

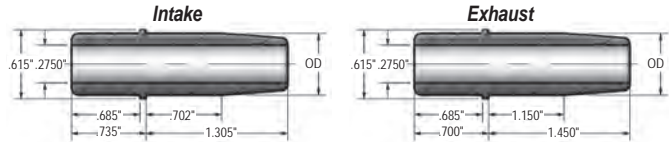

Twin Cam & Evo Sportster w/ 7mm Valves

• Use with 71028 (0.562") Viton Seals

Intake				Manganese Cast		
OD	ID	OAL	Size	Bronze	Iron	Replaces
.5620"	.2750"	2.040"	Std.	20-20690M	—	HVG-6600
.5630"			+ .001"	20-20691M	—	HVG-6601
.5640"			+ .002"	20-20692M	—	HVG-6602
.5720"			+ .010"	20-20699M	—	

Exhaust				Manganese Cast		
OD	ID	OAL	Size	Bronze	Iron	Replaces
.5620"	.2750"	2.150"	Std.	20-20700M	—	HVG-6700
.5630"			+ .001"	20-20701M	—	HVG-6701
.5640"			+ .002"	20-20702M	—	HVG-6702
.5720"			+ .010"	20-20709M	—	

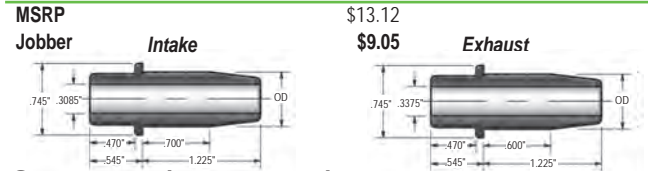

Sportster (1970-1983)

• Use with 71033 (intake) & 71034 (exhaust) OE-Style Seals

Intake				Manganese Cast		
OD	ID	OAL	Size	Bronze	Iron	Replaces
.5650"	.3085"	1.770"	Std.	—	20-2320C	HVG-5100C
.5660"			+ .001"	—	20-2321C	HVG-5101C
.5670"			+ .002"	—	20-2322C	HVG-5102C
.5750"			+ .010"	—	20-2329C	

Exhaust				Manganese Cast		
OD	ID	OAL	Size	Bronze	Iron	Replaces
.5650"	.3375"	1.770"	Std.	—	20-2330C	HVG-5200C
.5660"			+ .001"	—	20-2331C	HVG-5201C
.5670"			+ .002"	—	20-2332C	HVG-5202C
.5750"			+ .010"	—	20-2339C	

MSRP/Jobber		\$8.83/\$6.09
--------------------	--	---------------

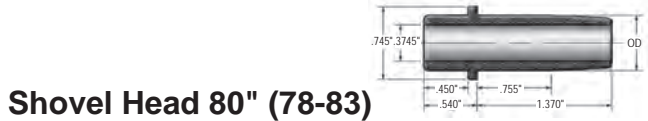

Shovel Head 80" (78-83)

• Use with 71011 Viton Valve seals or 71036 OE Style Seals

Intake or Exhaust				Manganese Cast		
OD	ID	OAL	Size	Bronze	Iron	Replaces
.6250"	.3745"	1.910"	Std.	20-2050M	20-2050C	HVG-5400
.6260"			+ .001"	20-2051M	20-2051C	HVG-5401
.6270"			+ .002"	20-2052M	20-2052C	HVG-5402
.6500"			+ .010"	20-50HSM	20-50HSC	

Shovel & Pan Heads

• Use with 71011 Viton seals or 71035 OE Style Seals

Intake or Exhaust				Manganese Cast		
OD	ID	OAL	Size	Bronze	Iron	Replaces
.5650"	.3745"	1.880"	Std.	20-2020M	20-2020C	
.5660"			+ .001"	20-2021M	20-2021C	HVG-5600S
.5670"			+ .002"	20-2022M	20-2022C	
.5680"			+ .003"	20-2023M	20-2023C	
.5750"			+ .010"	20-2029M	20-2029C	

MSRP		\$13.12	\$8.83
Jobber		\$9.05	\$6.09

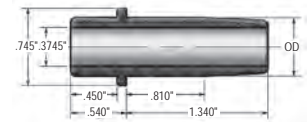

High Performance Valves



tech tips
from the techxperts™

Always check and confirm running clearances when installing new valves.

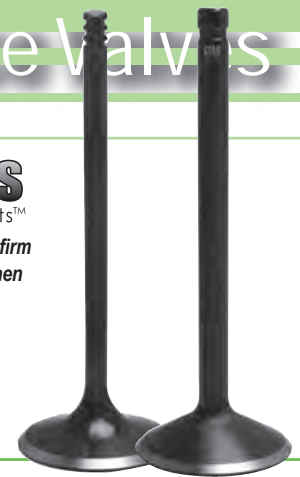

Black Diamond® Valves for Harley-Davidson® Engines

- **Light and strong with optimum airflow** A combination of stress analysis and flow bench testing for optimally balanced valve mass, strength and airflow characteristics.
- **Stellite tips for rocker applications** for resistance to the impact and abrasive wear common in rocker arm systems. This welded Stellite can never come loose.
- **Black Diamond™ Valves** One piece forged stainless steel valves impregnated by a special German process to improve wear properties and reduce friction. Provides resistance to corrosion and superior wear.

Application	Type	Head Diameter	Stem Diameter	Tulip Radius	Tulip Angle	Overall Length	MSRP	Jobber	Order No.	Replaces
Milwaukee Eight™	Intake	1.571" (39.90mm)	0.2347"	0.235	10°	4.015"	\$37.55	\$25.90	20-21012	—
	Intake	1.591" (40.40mm)	0.2347"	0.235	10°	4.015"	37.55	25.90	20-21015	—
	Intake	1.630" (41.40mm)	0.2347"	0.235	10°	4.055"	37.55	25.90	20-21013	—
	Exhaust	1.264" (32.11mm)	0.2342"	0.460	24°	4.050"	37.55	25.90	20-21016	—
	Exhaust	1.284" (32.61mm)	0.2342"	0.460	24°	4.050"	37.55	25.90	20-21017	—
Pan Head 1948-1965	Intake	1.750" (44.45mm)	0.3765"	0.234	23°	3.800"	29.81	20.56	20-4257	—
	Exhaust	1.750" (44.45mm)	0.3760"	0.234	29°	3.820"	25.10	17.31	20-4195	—
Sportster 1957-1969	Intake	1.825" (46.36mm)	0.3090"	0.375	23°	3.562"	37.55	25.90	20-4258	—
	Exhaust	1.570" (39.88mm)	0.3384"	0.236	29°	3.512"	25.10	17.31	20-4197	HD03
	Exhaust	1.630" (41.40mm)	0.3384"	0.236	29°	3.512"	37.55	25.90	20-4197-1	—
Sportster 1970-1983	Intake	1.935" (49.15mm)	0.3090"	0.256	23°	3.620"	25.10	17.31	20-4196	HD05
	Intake	1.950" (49.53mm)	0.3090"	0.256	23°	3.690"	37.55	25.90	20-4167	—
	Intake	2.000" (50.80mm)	0.3090"	0.256	23°	3.620"	29.81	20.56	20-4196-1	—
	Exhaust	1.570" (39.88mm)	0.3384"	0.236	29°	3.512"	25.10	17.31	20-4197	HD03
	Exhaust	1.630" (41.40mm)	0.3384"	0.236	29°	3.512"	37.55	25.90	20-4197-1	—
Shovelhead 74" 1966-1977	Intake	1.950" (49.53mm)	0.3765"	0.234	23°	3.885"	25.10	17.31	20-4194	HD09
	Intake	2.000" (50.80mm)	0.3765"	0.234	23°	3.885"	29.81	20.56	20-4256	—
	Exhaust	1.750" (44.45mm)	0.3760"	0.234	29°	3.810"	25.10	17.31	20-4195	HD07
	Exhaust	1.780" (45.21mm)	0.3760"	0.234	29°	3.820"	37.55	25.90	20-4195S	—
Shovelhead 80" 1978-1983	Exhaust	1.812" (46.02mm)	0.3760"	0.234	29°	3.820"	37.55	25.90	20-4195-1	—
	Intake	1.950" (49.53mm)	0.3780"	0.234	23°	3.885"	29.81	20.56	20-4294	—
	Exhaust	1.750" (44.45mm)	0.3775"	0.234	29°	3.810"	29.81	20.56	20-4295	—
Evolution 1984-1999	Intake	1.840" (46.74mm)	0.3100"	0.236	23°	4.445"	25.10	17.31	20-4171	—
	Intake	1.990" (50.55mm)	0.3108"	0.675	25°	4.440"	34.63	23.88	20-20905	HBV-1990
	Intake	1.940" (49.28mm)	0.3108"	0.675	25°	4.440"	34.63	23.88	20-20910	HBV-1940
	Intake	1.900" (48.26mm)	0.3108"	0.675	25°	4.440"	34.63	23.88	20-20915	HBV-1900
	Intake (Racing)	1.900" (48.26mm)	0.3100"	0.344	28°	4.420"	25.10	17.31	20-4171R	AV1900S
	Intake	2.150" (54.61mm)	0.3108"	0.550	24°	4.480"	25.10	23.88	20-20900	HCV-2150
	Exhaust	1.615" (41.02mm)	0.3096"	0.236	29°	4.525"	25.10	17.31	20-4170	HD10
	Exhaust (Racing)	1.630" (41.40mm)	0.3096"	0.500	40°	4.525"	25.10	17.31	20-4170R	—
	Exhaust	1.650" (41.91mm)	0.3106"	0.750	25°	4.515"	34.63	23.88	20-20920	HBV-1650
	Exhaust	1.610" (40.89mm)	0.3106"	0.750	25°	4.510"	34.63	23.88	20-20925	HBV-1610D
	Exhaust	1.585" (40.26mm)	0.3106"	0.750	25°	4.505"	34.63	23.88	20-20930	HBV-1585
	Evo Sportster Conversion	Intake	1.715" (43.56mm)	0.3100"	0.236	23°	4.550"	37.55	25.90	20-2010
Exhaust		1.480" (37.59mm)	0.3096"	0.500	40°	4.625"	37.55	25.90	20-2012	AV1480
Twin Cam 88"-103" 2005-2017	Intake	1.805" (45.85mm)	0.2760"	0.413	1.700"R	4.420"	29.81	20.56	20-20322	AV18107TGB
	Intake	1.900" (48.26mm)	0.2760"	0.344	28°	4.420"	29.81	20.56	20-20323R	—
	Exhaust	1.575" (40.00mm)	0.2755"	0.354	22°	4.520"	29.81	20.56	20-20325	—
	Exhaust	1.630" (41.40mm)	0.2755"	0.500	34°	4.520"	29.81	20.56	20-20326R	—
Buell® XB9™ 2003-2007	Intake	1.805" (45.85mm)	0.2760"	0.344	28°	4.525"	54.10	37.31	20-20260	—
	Intake	1.900" (48.26mm)	0.2760"	0.344	28°	4.500"	54.10	37.31	20-20262	—
	Exhaust	1.575" (40.00mm)	0.2755"	0.500	34°	4.610"	54.10	37.31	20-20265	—
	Exhaust	1.615" (41.02mm)	0.2755"	0.500	34°	4.590"	54.10	37.31	20-20266	—
Twin Cam, Sportster & Buell® Triple Groove	Intake	1.980" (50.29mm)	0.2757"	0.290	25°	4.455"	34.31	23.99	20-20935	HBV-1980-7TG
	Intake	1.900" (48.26mm)	0.2757"	0.475	24°	4.455"	34.31	23.99	20-20940	HBV-1900-7TG
	Exhaust	1.610" (40.89mm)	0.2755"	0.595	25°	4.545"	34.31	23.99	20-20945	HBV-1610-7TG
Evo, Big Twin & Twin Cam	Exhaust	1.575" (40.05mm)	0.2755"	0.595	25°	4.560"	34.31	23.99	20-20950	HBV-1575-7TG
	Intake	2.020" (51.31mm)	0.3108"	0.670	25°	4.440"	34.31	23.99	20-20990	HBV-2020A
S&S®, Screaming Eagle & Ultima®	Exhaust	1.700" (43.18mm)	0.3106"	0.600	25°	4.535"	34.31	23.99	20-20960	HBV-1700A
	Intake	2.020" (51.31mm)	0.3108"	0.645	25°	4.510"	34.31	23.99	20-20965	HBV-2020S
SE® / JIMS®	Exhaust	1.610" (40.89mm)	0.3106"	0.750	25°	4.565"	34.31	23.99	20-20970	HBV-1610S
	Exhaust	2.100" (53.34mm)	0.3108"	0.560	24°	4.475"	34.31	23.99	20-20955	HBV-2100

CYLINDER HEAD REBUILDING
CLEANING, ASSEMBLY & SAFETY
SHORT BLOCK REBUILDING
CRANKSHAFT/FLYWHEEL GRINDING
MISCELLANEOUS TOOLS & SUPPLIES
BRAKE SERVICE TOOLING
MEASURING TOOLS

NEW
7-MIL WEIR HARLERS
NEW
NEW

CYLINDER HEAD REBUILDING
CLEANING, ASSEMBLY & SAFETY
SHORT BLOCK REBUILDING
CRANKSHAFT/ FLYWHEEL GRINDING
MISCELLANEOUS TOOLS & SUPPLIES
BRAKE SERVICE TOOLING
MEASURING TOOLS
V-TWIN & METRIC HARD PARTS



Panhead 1948 to 1965 Valve Spring Kit

- OE Replacement
- Springs are heat-treated and shot peened for long life
- Kits include 4 Retainers, 4 Springs, 4 Keepers and 4 Base Washers

Max Lift	Installed Height	Seat Pressure	Open Pressure	@ Lift	MSRP	Jobber	Order No.
.415"	1.375"	129 lbs.	272 lbs.	.415"	\$121.95	\$84.10	20-20430



.600" Lift Shovelhead™ 1966 to 1977 Valve Spring Kit

- Springs are heat-treated and shot peened for long life
- Lightweight Racing Kits include 4 Retainers, 4 Springs, 4 Keepers and 4 Base Washers
- 7075-T6 Retainers offset .070" for taller installed height
- Base Washers are counter-bored to accept a .665" OD seal

Max Lift	Installed Height	Seat Pressure	Open Pressure	@ Lift	MSRP	Jobber	Order No.
.600"	1.510"	152 lbs.	387 lbs.	.600"	\$142.97	\$98.60	20-2110

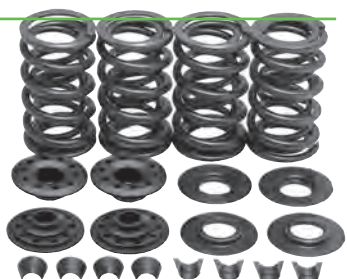

.600" Lift Evolution™ 1984 to 1999 Valve Spring Kit

- Springs heat-treated and shot peened for long life
- Lightweight Racing Kits include 4 Retainers, 4 Springs, 4 Keepers and 4 Base Washers

Max Lift	Installed Height	Seat Pressure	Open Pressure	@ Lift	MSRP	Jobber	Order No.
.600"	1.810"	175 lbs.	380 lbs.	.600"	\$142.97	\$98.60	20-20132



.600" Lift Shovelhead™ 1966 to 1977 Valve Spring Kit

- Springs heat-treated and shot peened for long life
- Lightweight Racing Kits include 4 Steel Retainers, 4 Springs, 4 Keepers and 4 Base Washers

Max Lift	Installed Height	Seat Pressure	Open Pressure	@ Lift	MSRP	Jobber	Order No.
.600"	1.510"	152 lbs.	387 lbs.	.600"	\$142.97	\$98.60	20-20450



.655" Lift Evolution™ 1984 to 1999 Valve Spring Kit

- Springs heat-treated and shot peened for long life
- Lightweight Racing Kits include 4 Retainers, 4 Springs, 4 Keepers and 4 Base Washers

Max Lift	Installed Height	Seat Pressure	Open Pressure	@ Lift	MSRP	Jobber	Order No.
.655"	1.860"	185 lbs.	450 lbs.	.655"	\$206.05	\$142.10	20-20081

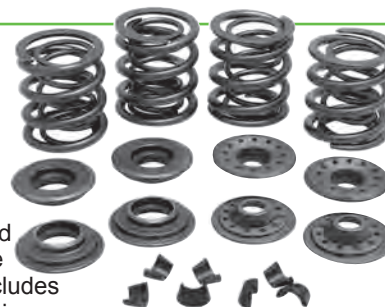

.415" Lift Shovelhead™ 1966 to 1977 Valve Spring Kit

- Springs heat-treated and shot peened for long life
- OE Replacement Kit includes 4 Steel Retainers, 4 Springs, 4 Keepers and 4 Base Washers

Max Lift	Installed Height	Seat Pressure	Open Pressure	@ Lift	MSRP	Jobber	Order No.
.415"	1.375"	129 lbs.	372 lbs.	.45"	\$121.95	\$84.10	20-20435

V-Twin On-the-Engine Valve Spring Compressor

Replace broken valve springs, install high performance valve springs, remove and replace valve guide seals all without disassembling the bike – just remove the gas tank and get to work. Use on Sportster, Evolution, Twin-Cam and most aftermarket V-Twins. Kit includes valve spring compressor, adaptor for compressing beehive springs, valve seal driver/installer and head pressurizing hose. Order No. **CF-HDIF** Jobber \$164.99





.610" Max Lift Beehive Valve Spring Set for 5/16" Valves

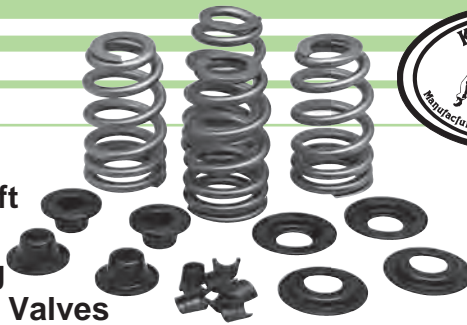

- Advanced spring design with special attention to cam and spring harmonics, stress, mass and operating RPM
- Premium grade, super clean ground chrome silicon wire
- Kits include 4 Retainers, 4 Springs, 4 Keepers and 4 Base Washers • **Supercedes HVS-6000S**

Max Lift	Installed Seat Height	Open Pressure	Open @ Pressure	MSRP	Jobber	Order No.
.610"	1.860"	175 lbs.	400 lbs.	\$168.17	\$115.98	20-21300

.660" Max Lift Beehive Valve Spring Sets for 5/16" Valves

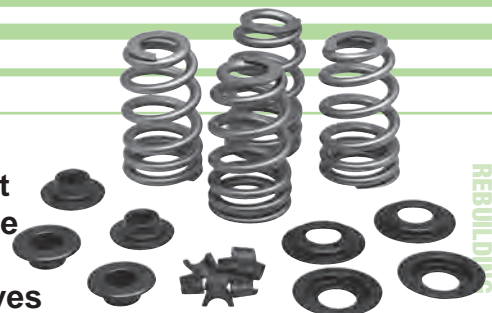

- 9° taper • Advanced spring design with special attention to cam and spring harmonics, stress, mass & operating RPM
- Premium grade, super clean ground chrome silicon wire
- Kits include 4 Retainers, 4 Springs, 4 Keepers and 4 Base Washers • **Supercedes HVS-6500S**

Max Lift	Installed Seat Height	Open Pressure	Open @ Pressure	MSRP	Jobber	Order No.
.660"	1.860"	178 lbs.	371 lbs.	\$168.17	\$115.98	20-21500

.610" Max Lift Beehive Valve Spring Sets for 7mm Valves



- Advanced spring design
- Premium grade, super clean ground chrome silicon wire
- Kits include 4 Retainers, 4 Springs, 4 Keepers and 4 Base Washers • **Supercedes HVS-6000-7SG**

Max Lift	Installed Seat Height	Open Pressure	Open @ Pressure	MSRP	Jobber	Order No.
.610"	1.860"	175 lbs.	400 lbs.	\$168.17	\$115.98	20-21400

.660" Max Lift Beehive Valve Spring Sets for 7mm Valves



- 9° taper
- Advanced spring design
- Premium grade, super clean ground chrome silicon wire
- Kits include 4 Retainers, 4 Springs, 4 Keepers and 4 Base Washers • **Supercedes HVS-6500-7SG**

Max Lift	Installed Seat Height	Open Pressure	Open @ Pressure	MSRP	Jobber	Order No.
.660"	1.860"	178 lbs.	371 lbs.	\$165.29	\$113.98	20-21550

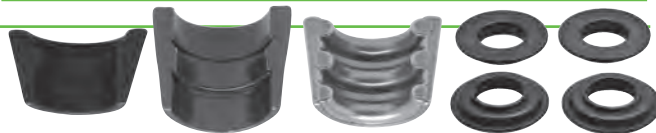

Spring Kit Replacement Keepers

- Several to choose from • 4 Sets per pack

Fits	Stem Dia.	Keeper Angle	Bead Height	OAL	Minor Dia.	MSRP	Jobber	Order No.
Pan/Shovel	.375"	15°	—	.305"	.403"	\$42.89	\$22.99	51005-4
Evolution	.310"	15°	.220"	.365"	.360"	42.89	22.99	51003-4
20-21300	.310"	7°	.190"	.380"	.380"	42.89	22.99	51014-4
20-21500	.310"	9°	.140"	.345"	.398"	42.89	22.99	51031-4
20-21400	.275"	7°	—	.290"	.345"	42.89	22.99	51016-4
20-21550	.275"	9°	—	.345"	.398"	42.89	22.99	51030-4
Shovelhead 80" Conversion Basewashers						49.29	33.99	20-20855

Pan/Shovel Spring Seat Cutting Tool

- Convert Pan & early Shovels to late style Shovel easily to attain higher lift
- Spacer stops the cutter at the correct height for uniform spring spacing
- Use with lower spring collars or stock late-style lower spring collars (1980-1984) • OD: 1.680" • ID: 0.750"



Description	Jobber	Order No.
Spring Seat Cutting Tool	\$92.99	VSS-1680HD
.375" Spring Pad Pilot	31.99	VP-375

Compression Release Valves

- 2 per pack
- 10 x 1.0mm thread
- High temperature resistant knobs
- Shorter thread sections makes installation easier with less drilling required than with OE-style



Application	Length	Thread	MSRP	Jobber	Order No.
Evolution	1.400"	.350"L	\$68.14	\$39.99	20-21250
Twin Cam	1.730"	.350"L	68.14	39.99	20-21255
OE Replacement	1.750"	.500"L	68.14	39.99	20-21260

Keeper Installation Tools

Best Keeper Tool on the Market!

- Spring-loaded plunger
- For single & multi-groove keepers
- Reaches keeper grooves located farther from the valve tip • Ideal for use with **CF-500** (p. 39) and **PSB-5000** (p. 38)

Size	Jobber	Order No.
5mm / .2031"	\$79.99	VKI-5
6mm / .2344"	79.99	VKI-6
7mm / .2812"	79.99	VKI-7
8mm / .3125"	79.99	VKI-8
Replacement Rubber Sleeve	6.99	VKI-56

CYLINDER HEAD REBUILDING ASSEMBLY & SAFETY CLEANING, SHORT BLOCK REBUILDING PLYWHEEL GRINDING CRANKSHAFT/ MISCELLANEOUS TOOLS & SUPPLIES TOOLS BRAKE SERVICE TOOLS MEASURING TOOLS V-TWIN & METRIC HARD PARTS



A rapid-use index of product categories

Cylinder Head Rebuilding

Pilots.....	1-3
Valve Seat Work.....	4-22
Valve Refacing.....	23-25
Reamers.....	26-27
Valve Guide Resizing.....	28-30
Valve Guide Replacement.....	31-35
Valve Seal Work.....	36
Valve Spring Work.....	37-43
Cylinder Head Resurfacing.....	44-47
Crack Detection & Repair.....	48-53
Porting & Polishing.....	57-59

Cleaning, Assembly & Safety

Parts Storage & Organizers.....	60, 66
Wire Wheels & Brushes.....	62-63
Cleaning.....	62-69
Parts Baskets.....	66
Last Blast Paint & Metal Markers.....	70
Assembly Lubes.....	71
Flex-Hones®.....	72

Index Falls between pages 72 and 73

Coolants & Lubricants.....	73
----------------------------	----

Short Block Rebuilding

Cylinder Boring & Honing.....	74-81
Boring Bar Tooling & Supplies.....	74-75
Honing Stones.....	76-81
Rod Honing.....	82-83
Rod & Piston Work.....	84-89
Lifter Bore Tooling.....	91
Camshaft Work.....	92-93

Crankshaft/Flywheel Grinding

Crankshaft Grinding Wheels.....	94-95
Crankshaft Grinding & Polishing.....	96-100
Flywheel Grinding.....	102-104

Miscellaneous Tools

Diamond Dresser Tools.....	106-107
Machine Replacement Parts.....	108-109

Brake Service Tooling

Brake Tips & Holders.....	110-111
Brake Lathe Silencers.....	112
Brake Lathe Replacement Parts.....	113-115
Brake Lathe Mounting Adaptors.....	116

Measuring Tools

Dial Bore Gauges.....	118-119
Micrometers.....	120
Calipers & Dial Indicators.....	121

V-Twin & Metric Hard Parts

Seats & Seat Inserts.....	122, 123
Valve Guides.....	122, 124
Replacement Valves.....	122, 125
Valve Springs.....	122, 126-127

© Copyright 2019, Goodson Mfg. Co., Inc. All copy and illustrations are copyrighted. Absolutely no mechanical or electronic reproduction or use of any part is allowed without our prior written permission. Goodson reserves the right to correct printing errors. Prices are subject to change without notice.

Magnetic Finger Glove

- Turns your index finger into a powerful tool
- Holds any small magnetic part securely
- Complete jobs faster with less effort
- No more cuts from installing and retrieving metal parts
- One size fits most
- Order No. **RW-MAG** Jobber \$9.99



GOODSON Gear

Sport Goodson gear around the shop, at the track or just out and around!

Description	Color	Sizes	Jobber	Order No.
Ladies' Cut Cotton T-Shirt	Black	Medium	\$13.99	RWW-GTB-M
		Large	13.99	RWW-GTB-L
		X-Large	13.99	RWW-GTB-XL
Pre-Shrunk Cotton T-Shirts	White	Large	8.99	RW-GTW-L
		X-Large	8.99	RW-GTW-XL
		XX-Large	10.99	RW-GTW-XXL
	Black	Large	8.99	RW-GTB-L
		X-Large	8.99	RW-GTB-XL
		XX-Large	10.99	RW-GTB-XXL
Caps	Black	adjustable	7.99	RW-GR-CAP
Microfiber Jacket	Black	Large	44.99	RW-MFJ-L
		X-Large	44.99	RW-MFJ-XL
		XX-Large	54.99	RW-MFJ-XXL
Shop Apron	Black	n/a	27.99	CA-100
Can Cooler	Black	n/a	0.99	RW-CC
Stocking Hat	Black	n/a	8.99	RW-SH

CYLINDER HEAD REBUILDING
CLEANING, ASSEMBLY & SAFETY
SHORT BLOCK REBUILDING
CRANKSHAFT/FLYWHEEL GRINDING
MISCELLANEOUS TOOLS & SUPPLIES
BRAKE SERVICE TOOLING
MEASURING TOOLS
V-TWIN & METRIC HARD PARTS

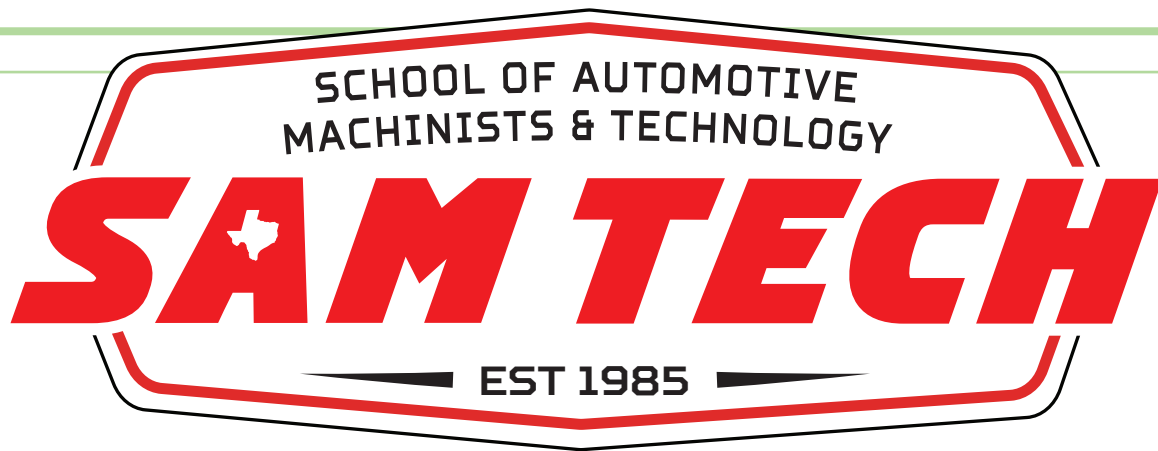

Wisdom from the Machine Shop

The **School of Automotive Machinists & Technology** is a provider of machining and technical education training for students seeking careers in the motorsports industry.

Founded in 1985, in Houston, Texas, **SAM Tech** offers programs in Engine Block Machining, Cylinder Head Machining, CNC Machining, EFI Calibration, and Associates Degree classes. Our graduates work for performance race shops, parts manufacturers, professional race teams, and some start their own engine building shops or parts manufacturing companies.

SAM Tech graduates are hired by the best in the performance racing industry, whether that's on championship teams in NASCAR, NHRA, and IRL, or the best in automotive manufacturing including GM, Ferrea, CP-Carrillo, Wiseco, and many others.

SAM Tech has been named a National School of Excellence by the Accrediting Commission of Career Schools and Colleges after our last two re-accreditations and is a Military Friendly School. For more information visit samtech.edu

Our longstanding relationship with Dave Monyhan and Goodson has been a tremendous asset to the School and students alike. Goodson's sponsorship has allowed SAM Tech instructors to teach our students machining with the latest and best tooling on the market today. We appreciate and value the excellent one on one service the entire team at Goodson provides, whether it's advice regarding special tooling, questions about ordering, or the quick service from the shipping department. We would like to extend a huge THANK YOU to everyone at Goodson for their continued support!

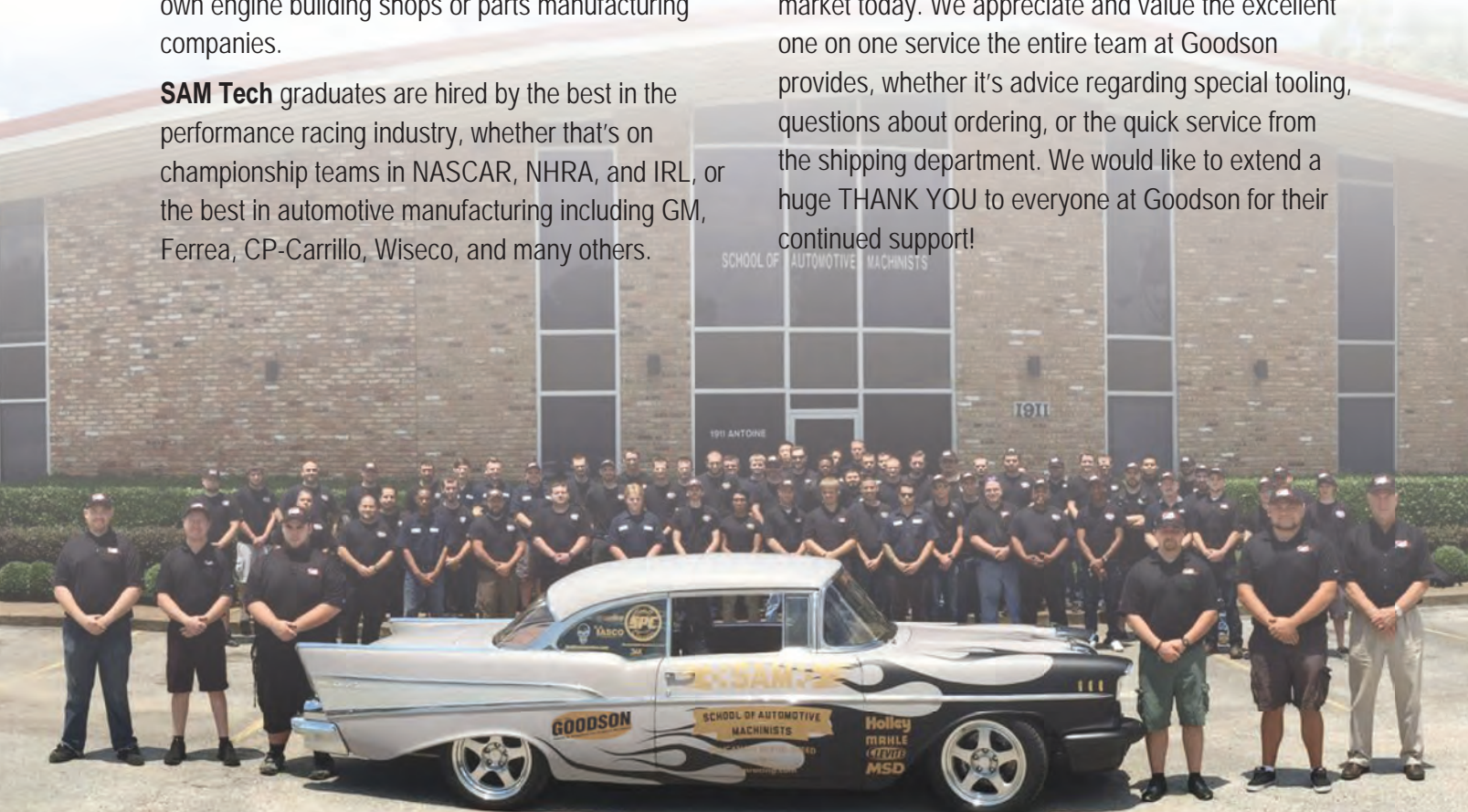

GOODSON

Tools and Supplies for Engine Builders

156 Galewski Drive | Winona, MN 55987

Easy Toll-Free Ordering by Phone
1-800-533-8010

Toll-Free Fax 24-Hours a Day
1-888-466-3909

Order Online!
www.goodson.com

Source Code

Account Number

Stay Connected With Goodson



GoodsonToolsAndSupplies



goodson_tools



@GoodsonTools



@GoodsonDave



Goodson ShopSupplies



Goodson Gazette

Get Instant Horsepower

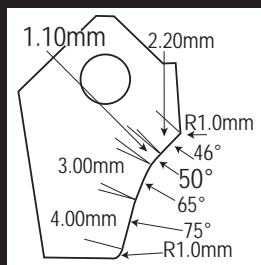

3-D Fast Cut™ Seat Cutting System is the most complete tool system available

- Cut precise multi-angle seats with your existing pilots
- Remove material and contour bowls with the bowl profiler tool holder
- Cut spring pads with the universal spring pad cutter
- Convert your Sunnen® or Mira® brazed cutters to 3-D with cutter holders
- Drive brazed carbide or indexable counter-bore cutters with the seat cutter driver

See pages 4 to 10 for complete details