

SILV-O-LITE[®]

Better Pistons Since 1922



**CAST STOCK REPLACEMENT
FOR FOREIGN AND DOMESTIC**



Better Pistons Since 1922

1mm = .03937" .001" = .0254mm

Fractions	Decimals	Millimeters	Fractions	Decimals	Millimeters	MM	INCHES	MM	INCHES
1/64"	.015625"	0.397	33/64"	.515625"	13.097	.1	.0039"	47	1.8504"
1/32"	.03125"	0.794	17/32"	.53125"	13.494	.2	.0079"	48	1.8898"
3/64"	.046875"	1.191	35/64"	.546875"	13.891	.3	.0118"	49	1.9291"
1/16"	.0625"	1.588	9/16"	.5625"	14.288	.4	.0157"	50	1.9685"
5/64"	.078125"	1.984	37/64"	.578125"	14.684	.5	.0197"	51	2.0079"
3/32"	.09375"	2.381	19/32"	.59375"	15.081	.6	.0236"	52	2.0472"
7/64"	.109375"	2.778	39/64"	.609375"	15.478	.7	.0276"	53	2.0866"
1/8"	.1250"	3.175	5/8"	.6250"	15.875	.8	.0315"	54	2.1260"
9/64"	.140625"	3.572	41/64"	.640625"	16.272	.9	.0354"	55	2.1654"
5/32"	.15625"	3.969	21/32"	.65625"	16.669	1	.0394"	56	2.2047"
11/64"	.171875"	4.366	43/64"	.671875"	17.066	2	.0787"	57	2.2441"
3/16"	.1875"	4.763	11/16"	.6875"	17.463	3	.1181"	58	2.2835"
13/64"	.203125"	5.159	45/64"	.703125"	17.859	4	.1575"	59	2.3228"
7/32"	.21875"	5.556	23/32"	.71875"	18.256	5	.1969"	60	2.3622"
15/64"	.234375"	5.953	47/64"	.734375"	18.653	6	.2362"	61	2.4016"
1/4"	.2500"	6.350	3/4"	.7500"	19.050	7	.2756"	62	2.4409"
17/64"	.265625"	6.747	49/64"	.765625"	19.447	8	.3150"	63	2.4803"
9/32"	.28125"	7.144	25/32"	.78125"	19.844	9	.3543"	64	2.5197"
19/64"	.296875"	7.541	51/64"	.796875"	20.241	10	.3937"	65	2.5591"
5/16"	.3125"	7.938	13/16"	.8125"	20.638	11	.4331"	66	2.5984"
21/64"	.328125"	8.334	53/64"	.828125"	21.034	12	.4724"	67	2.6378"
11/32"	.34375"	8.731	27/32"	.84375"	21.431	13	.5118"	68	2.6772"
23/64"	.359375"	9.128	55/64"	.859375"	21.828	14	.5512"	69	2.7165"
3/8"	.3750"	9.525	7/8"	.8750"	22.225	15	.5906"	70	2.7559"
25/64"	.390625"	9.922	57/64"	.890625"	22.622	16	.6299"	71	2.7953"
13/32"	.40625"	10.319	29/32"	.90625"	23.019	17	.6693"	72	2.8346"
27/64"	.421875"	10.716	59/64"	.921875"	23.416	18	.7087"	73	2.8740"
7/16"	.4375"	11.113	15/16"	.9375"	23.813	19	.7480"	74	2.9134"
29/64"	.453125"	11.509	61/64"	.953125"	24.209	20	.7874"	75	2.9528"
15/32"	.46875"	11.906	31/32"	.96875"	24.606	21	.8268"	76	2.9921"
31/64"	.484375"	12.303	63/64"	.984375"	25.003	22	.8661"	77	3.0315"
1/2"	.5000"	12.700	1"	1.000"	25.400	23	.9055"	78	3.0709"
						24	.9449"	79	3.1102"
						25	.9843"	80	3.1496"
						26	1.0236"	81	3.1890"
						27	1.0630"	82	3.2283"
						28	1.1024"	83	3.2677"
						29	1.1417"	84	3.3071"
						30	1.1811"	85	3.3465"
						31	1.2205"	86	3.3858"
						32	1.2598"	87	3.4252"
						33	1.2992"	88	3.4646"
						34	1.3386"	89	3.5039"
						35	1.3780"	90	3.5433"
						36	1.4173"	91	3.5827"
						37	1.4567"	92	3.6220"
						38	1.4961"	93	3.6614"
						39	1.5354"	94	3.7008"
						40	1.5748"	95	3.7402"
						41	1.6142"	96	3.7795"
						42	1.6535"	97	3.8189"
						43	1.6929"	98	3.8583"
						44	1.7323"	99	3.8976"
						45	1.7717"	100	3.9370"
						46	1.8110"		

SUPERSEDES CATALOG 2016

Catalog and Ordering Information 2
 Special Orders, Returned Good, Technical Services 3
 Label / Lot No., Casting Date Code 4
 Piston Terminology, Diamond Finishing, Coated Pistons . . . 5
 Aluminum Alloys for Pistons 6
 New Piston Numbers 7
 Alphabetical Listing by Manufacturer: 8
 Numerical Listing 98
 Interchange Listings 105
 Determining Compression Ratio 107
 Checking Clearance for Silvolite Pistons 108
 Clearance Chart for Silvolite Pistons 109

ALPHABETICAL LISTING BY MANUFACTURER:

AMC / Jeep / Eagle 8
 Buick *See General Motors Corp.*
 Cadillac *See General Motors Corp.*
 Chevrolet *See General Motors Corp.*
 Chrysler Corp. 15
 Continental 25
 Datsun *See Nissan*
 Dodge *See Chrysler Corp.*
 Ford Motor Co. 25
 General Motor Corporation 48
 GEO *See General Motors Corp.*
 GMC Truck *See General Motor Corp.*
 Holden 78
 Honda 81
 Hyundai 82
 IHC / Navistar 82
 Infiniti *See Nissan*
 Isuzu 84
 Lexus *See Toyota*
 Lincoln *See Ford Motor Co.*
 Mazda 85
 Mercruiser 86
 Mercury *See Ford Motor Co.*
 Mitsubishi 89
 Nissan 91
 Oldsmobile *See General Motors Corp.*
 Plymouth *See Chrysler Corp.*
 Pontiac *See General Motors Corp.*
 Rover 93
 Saturn *See General Motors Corp.*
 Suzuki 94
 Subaru 94
 Toyota 95
 Triumph 97
 Volkswagen 97



UNITED ENGINE & MACHINE CO.

- Entries in the alphabetical listing are arranged first by engine displacement, then by years.
- Pistons are for gasoline engines unless noted otherwise.
- Suffix "C" "Coating" denotes pistons having a dry film lubricant applied to skirts.
- Suffix "D" following a piston number denotes a DUALOY piston with an Al-Fin bonded ferrous (iron) top ring groove protector.
- Suffix "H" denotes a HYPEREUTECTIC piston.
- Some passenger car and light and medium duty truck pistons are destroked to allow for block and cylinder head resurfacing. This reduces the compression ratio by approximately 1/4 ratio if the block and head have not been resurfaced. Many Hypereutectic pistons have not been destroked. It is suggested that the compression height be checked before ordering.
- The compression ratio is the ratio that will result when the standard (STD.) size Silv-O-Lite piston is substituted for the original equipment piston. These ratios have been calculated from the best published data available to us. While every effort has been made to use authoritative sources we cannot guarantee the accuracy of such data and, hence, cannot assume responsibility for the resulting compression ratios calculated therefrom.
- Boring an engine .030" oversize will increase the compression ratio approximately 1/10 of a ratio, boring to .060" oversize approximately 1/4 of a ratio.
- All pistons are furnished with pins and, if required, lockrings.
- Oversize pistons are offered solely in response to customer demand and, in offering them, United Engine and Machine Company makes no warranty either expressed or implied as to the oversize to which an engine can be safely bored nor as to availability of piston rings.
- Single pistons can now be purchased in all listed oversizes.

ORDERING INFORMATION

1. When ordering use telephone number 1-800-648-7970.
2. Specify quantity of pistons rather than number of sets desired as some pistons fit both six & eight cylinder engines.
3. Give the piston number and size desired.
Regularly stocked sizes are Std. and .020", .030", .040", .060" oversizes.
Pistons for metric engines can be identified by the "mm" size shown in the Part No./Sizes column. Such pistons are stocked in Std. and .5mm, .75mm, 1.0mm, 1.5mm oversizes.

United Engine & Machine Co. offers to its customers the ability to place a special order for Silvolite pistons that:

- Require special oversizes
- Require non O.E. dimensions or features (i.e. ring packs, compression heights, pin hole diameters, skirt coatings, heat treatments, balance/weight requirements)
- Are made of different aluminum alloys
- Have been obsoleted from our current catalog (provided that tooling is available)

Call our Tech Department at (800) 648-7970 and request a Special Order Request Form.

Fill out the form and return to United Engine & Machine's Tech Dept. for review and a price quote.

****Special orders that can be manufactured will require a 250 piece minimum order.***

RETURNED GOODS

All returns must be authorized in advance and require an RGA.

Please phone our Returned Goods Authorization (RGA) Representative at 1-800-648-7970 for instructions regarding any and all returns.

TECHNICAL SERVICES

For technical support or catalog questions please call 1-800-648-7970 and select option 3. We encourage you to also visit our website at www.uempistons.com.



LABEL/LOT NUMBER



For product traceability, the lot/production number and casting date is printed on the container label. If necessary a piston production history can be reviewed when this label information is provided to the factory.

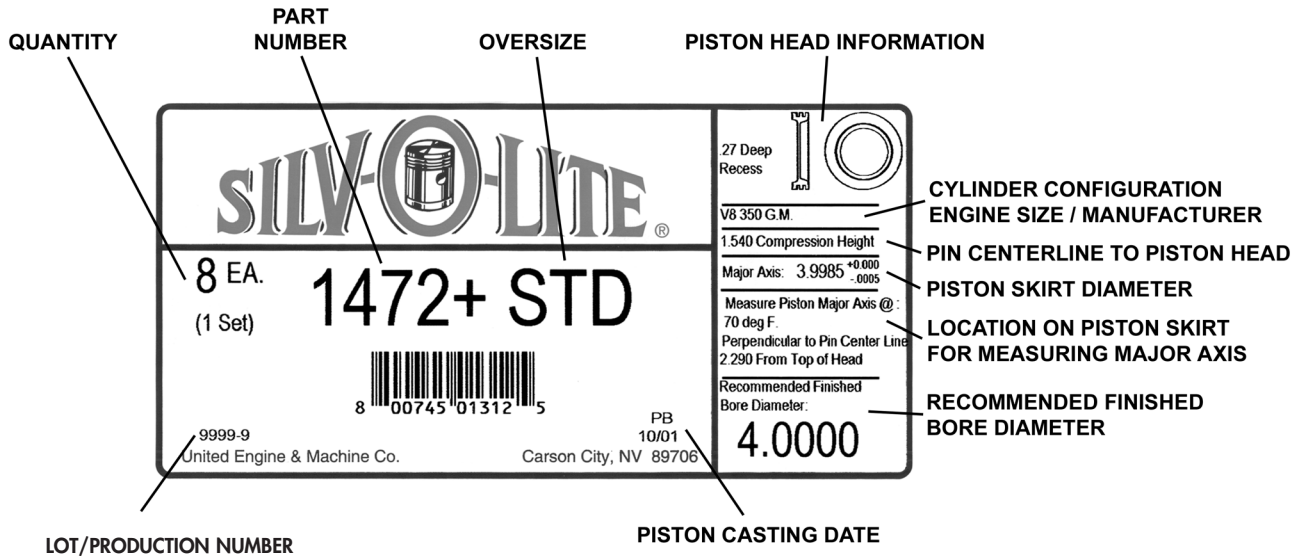

CASTING DATE CODE

Most Silv-O-Lite pistons have a monthly calendar cast on the inside of the skirt. Each dot represents a month. The double dot represents December. Reading clockwise from the double dots, the next dot is January, then clockwise to February, etc.

In the center of the cast circular calendar is the piston part number. Directly beneath the part number is a two digit number indicating the year, i.e.; "02" represents 2002. The illustration to the right indicates a casting date of "June '02".

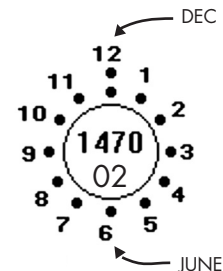
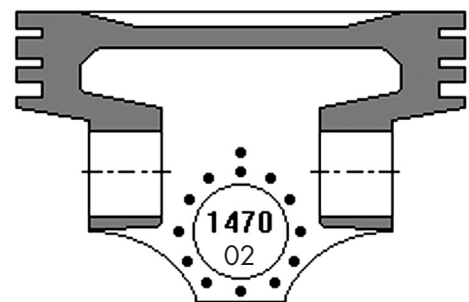

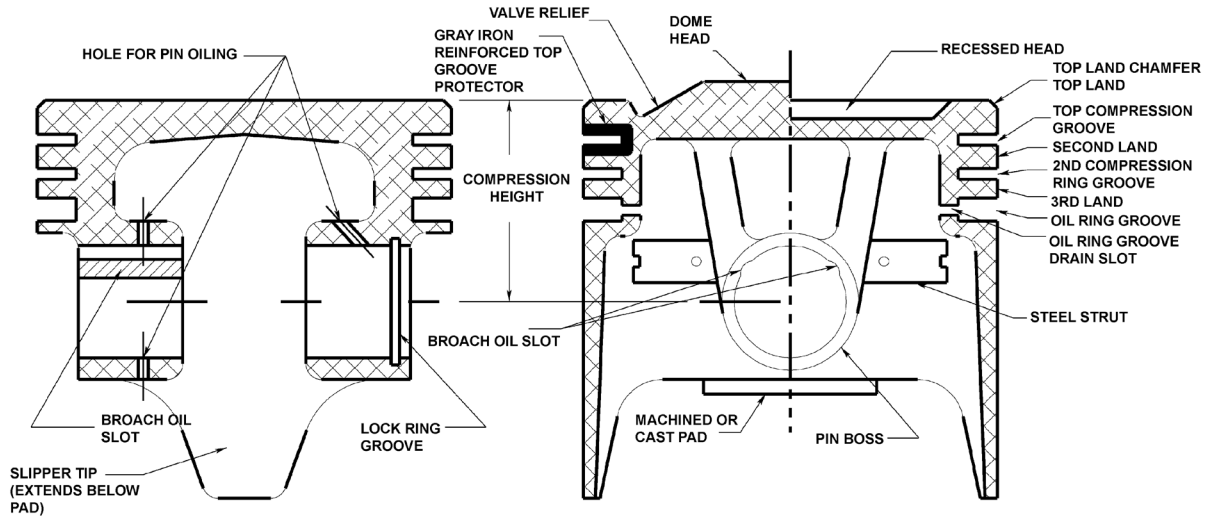

DIAMOND FINISHING

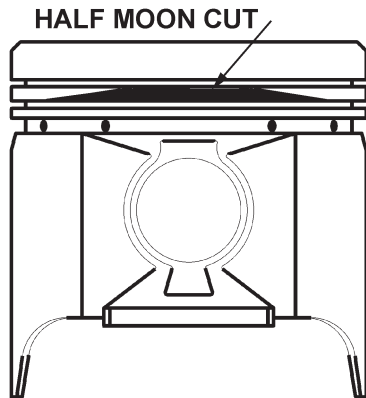

Silv-O-Lite has been diamond finishing piston skirts for over 25 years.

Silv-O-Lite's diamond finishing is not a lathe or grinding operation. This unique process actually holds the piston stationary while spinning the cutting tool around the perimeter of the piston. In one simultaneous action ellipse, taper, & barrel are cut. One trade mark of the diamond finishing process is a **small half moon cut** that may show up **on the second land**. If this mark is not present, it is because the piston requires less ellipse or has smaller land diameter. Even without this identification you can be assured that all Silv-O-Lite pistons are finished with this proprietary process.

Silv-O-Lite has combined the accuracy of the diamond with the speed of the computer and over 90 years of engineering experience to give you the most consistent skirt finish in the industry. For more information on this unique process contact 1-800-648-7970.

COATED PISTONS



- A "C" suffix has been added to the part numbers of pistons coated with an anti-friction dry lubricant.
- The label on the piston container indicates "COATED" & lists the "Recommended Finished Bore Diameter".
- Pistons that have dry film lubricant applied to the skirts are approximately .001 larger in diameter than uncoated pistons.
- Failure to follow the "Recommended Finished Bore Diameter" can result in piston failure.

United Engine

Uses gravity feed permanent molds to produce aluminum pistons.

Aluminum, alloyed with copper, magnesium, nickel and silicon are common piston alloys in use today. Silicon is the major alloying element added to the aluminum. It offers a number of benefits in the area of piston production and piston operation.

- **Machinability**
- **Corrosion Resistance**
- **Weight Reduction**
- **Improvement in Hardness And Strength**
- **Improvement in Expansion Characteristics**
- **Improvement in Wear and Scuff Resistance**

Aluminum silicon alloys used in pistons fall into three major categories: eutectic, hypoeutectic and hypereutectic. Probably the easiest way to describe these categories is to use the analogy of sugar added to a glass of iced tea. When sugar is added and stirred into the iced tea it dissolves and becomes inseparable from the iced tea. If sugar is continuously added, the tea actually becomes saturated with sugar and, no matter how much you stir, the excess sugar will not mix in and simply falls to the bottom of the glass in crystal form.

Silicon additions to aluminum are very similar to the sugar addition to the iced tea. Silicon can be added and dissolved into aluminum so it, too, becomes inseparable from the aluminum. If these additions continue, the aluminum will eventually become saturated with silicon. Silicon added above this saturation point will precipitate out in the form of hard, primary silicon particles similar to the excess sugar in the iced tea.

This point of saturation in aluminum is known as the eutectic and occurs when the silicon level reaches 12%. Aluminum with silicon levels below 12% are known as hypoeutectic, (the silicon is dissolved into the aluminum matrix). Aluminum with silicon levels above 12% are known as hypereutectic, (aluminum with 16% silicon has 12% dissolved silicon and 4% shows up as primary silicon crystals).

Silvolite's hypereutectic pistons use an alloy containing 15 - 16% silicon. In addition to greater strength, scuff and seizure resistance, the hypereutectic will improve groove wear and resist cracking in the crown area where operating temperatures are severe.

It is primary silicon that gives the hypereutectic its thermal and wear characteristics. The primary silicon acts as small insulators keeping the heat in the combustion chamber and prevents heat transfer, thus allowing the rest of the piston to run cooler. Hypereutectic aluminum has 15% less thermal expansion than conventional piston alloys.

IMPORTANT:

When using Hypereutectic pistons we recommend 40% increase in listed top ring end gap.

ADDED SINCE CATALOG 2017

<u>Part Number</u>	<u>Make/Engine Code</u>	<u>Cylinders</u>	<u>Cubic Inch</u>	<u>Liter</u>	<u>Years</u>	<u>Page</u>
3260HCA	CHRYSLER HEMI	V8	345	5.7L	2009-11	23
3339HCA	FORD DURATEC	V6	214	3.5L	2007-10	31
3340HCA	FORD DURATEC	V6	214	3.5L	2010-16	31
3536HC	GM	V8	350	5.7L	1969-90	70
3537HCA	GM Ecotec	L4	146	2.4L	2005-15	52
3539HCA	GM LFX	V6	217	3.6L	2012-18	57
3538HCA	GM LLT	V6	217	3.6L	2007-17	57



AMC/JEEP/EAGLE

CYL BORE ENGINE	YEAR COMP. RATIO	VIN CODE	NOTES	PART NO. SIZE	RINGS	O.E. ASSY. NO. INTERCHANGE	HEAD SHAPE
L4-090 1.5L 2.9724(IN) 75.5(MM) MITSUBISHI ENGINE	1991-95 9.2	A	Hypereutectic. 2.560" dia. head recess .020" deep w/2 valve reliefs. Not intended for Racing applications. COMP HT: 1.133 PIN DIA: .7090 Offset	3213H STD. .5mm .75mm 1.0mm	1-1.2mm 1-1.5mm 1-3.0mm	MD144901 FM H13130P	
L4-110 1.8L 3.1732(IN) 80.6(MM) MITSUBISHI ENGINE	1989-94 9.0	B C	4G37 Engine. Dome head .150" high w/2 valve reliefs COMP HT: 1.320 PIN DIA: .7485 Offset	3216 STD. .5mm .75mm 1.0mm	2-1.5mm 1-4.0mm	MD100416	
L4-110 1.8L 3.1890(IN) 81.0(MM) MITSUBISHI ENGINE	1990-94 9.5	C	16 Valve SOHC. 113 HP. Dome head .010" high w/2 valve reliefs. COMP HT: 1.210 PIN DIA: .7480 Offset	3220 STD. .5mm .75mm 1.0mm	2-1.2mm 1-2.8mm	MD190610 MD183457 MD174995	
L4-122 2.0L 3.4449(IN) 87.5(MM) CHRYSLER ENGINE	1995-99 9.6	Y	DOHC. Dome head .035" high w/4 valve reliefs. COMP HT: 1.230 PIN DIA: .8267 Offset	3228 STD. .5mm .75mm 1.0mm	2-1.2mm 1-3.0mm Shallow Groove	4741372 4797613	
L4-122 2.0L 3.4449(IN) 87.5(MM) CHRYSLER ENGINE	1995-99 9.6	Y	Hypereutectic. DOHC. Dome head .035" high w/4 valve reliefs. "COATED SKIRTS". Not intended for Racing applications. COMP HT: 1.230 PIN DIA: .8267 Offset	3228HC STD. .5mm .75mm 1.0mm	2-1.2mm 1-3.0mm Shallow Groove	4741372 4797613 FM H853CP	
L4-134 2.2L 3.1250(IN) 79.4(MM) CONTINENTAL ENGINE	1941-71 6.7 7.0		L and F flat head. Three ring piston. Top groove is a carbon collector. COMP HT: 2.167 PIN DIA: .8120 Center	2606 STD. .010 .020 .030 .040 .060 .080	2-3/32 1-3/16	801476 FM 88NP	
L4-143 2.4L 3.4055(IN) 86.5(MM) MITSUBISHI ENGINE	1992-93 8.5	W G	Flat head w/3 valve reliefs. COMP HT: 1.370 PIN DIA: .8267 Offset	3225 STD. .5mm .75mm 1.0mm	2-1.5mm 1-4.0mm	MD105377 FM 12958P	
L4-143 2.4L 3.4055(IN) 86.5(MM) MITSUBISHI ENGINE	1993-96 9.5	G	4G64 Engine. 3.100" dia. head recess .160" deep COMP HT: 1.360 PIN DIA: .8665 Offset	3221 STD. .5mm .75mm 1.0mm	1-1.2mm 1-1.5mm 1-2.8mm	MD188115	

AMC/JEEP/EAGLE

CYL BORE ENGINE	YEAR COMP. RATIO	VIN CODE	NOTES	PART NO. SIZE	RINGS	O.E. ASSY. NO. INTERCHANGE	HEAD SHAPE
L4-151 2.5L 3.8750(IN) 98.4(MM) AMC ENGINE	1983-95	U	"D" shaped head recess .100" deep.	2228	2-5/64 1-3/16	8983500251	
	9.2		COMP HT: 1.581 PIN DIA: .9310 Offset	STD. .010 .020 .030 .040 .060		FM 525AP	
L4-151 2.5L 3.8750(IN) 98.4(MM) AMC ENGINE	1983-95	U	"D" shaped head recess .100" deep. *Same as 2228 with "COATED SKIRTS".	2228C	2-5/64 1-3/16	8983500251	
	9.2		COMP HT: 1.581 PIN DIA: .9310 Offset	STD. .010 .020 .030 .040 .060		FM 525ACP	
L4-151 2.5L 3.8750(IN) 98.4(MM) AMC ENGINE	1996-02	P	Hypereutectic. "D" shaped head recess .116" deep. "COATED SKIRTS". Not intended for Racing applications.	3238HC	2-1.5mm 1-4.0mm Shallow Groove	04798331	
	9.1		COMP HT: 1.592 PIN DIA: .9310 Offset	STD. .020 .030 .040 .060		FM H822CP	
L4-151 2.5L 3.8750(IN) 98.4(MM) AMC ENGINE	1996-02		Hypereutectic. "D" shaped head recess .116" deep. "COATED SKIRTS". Not intended for Racing applications. Same as 3238 HC w/early ring pack	3243HC	2-5/64 1-3/16		
	9.1		COMP HT: 1.592 PIN DIA: .9310 Offset	STD. .020 .030 .040 .060		FM H823CP	
L4-151 2.5L 4.0000(IN) 101.6(MM) PONTIAC ENGINE	1979-93	A R	Hypereutectic. 3.100" dia. head recess .145" deep. Full sets only. Not intended for Racing applications.	1533H	1-1/16 1-5/64, 1-3/16 Shallow Groove	10101488 10044245 10112445 10112444 10042191 10101488	
	9.0 8.3		COMP HT: 1.566 PIN DIA: .9273 Offset	STD. .020 .030 .040 .060		FM H547P	
L4-151 2.5L 4.0000(IN) 101.6(MM) PONTIAC ENGINE	1979-93	A R	Hypereutectic. 3.100" dia. head recess .145" deep. Full sets only. *Same as 1533H with "COATED SKIRTS". Not intended for Racing applications.	1533HC	1-1/16 1-5/64, 1-3/16 Shallow Groove	10101488 10044245 10112445 10112444 10042191 10101488	
	9.0 8.3		COMP HT: 1.566 PIN DIA: .9273 Offset	STD. .020 .030 .040 .060		FM H547CP	
L4-151 2.5L 4.0000(IN) 101.6(MM) PONTIAC ENGINE	1980-83		3.020" dia. head recess .226" deep. Replace in full sets only.	1528	2-5/64, 1-3/16	8132448 8133673 8133823 8134136	
	8.2		COMP HT: 1.570 PIN DIA: .9273 Offset	STD. .020 .030 .040 .060		FM 465AP	
L4-151 2.5L 4.0000(IN) 101.6(MM) PONTIAC ENGINE	1980-83		Hypereutectic. 3.020" dia. head recess .226" deep. Replace in full sets only. "COATED SKIRTS". Not intended for Racing applications.	1528HC	2-5/64, 1-3/16	8132448 8133673 8133823 8134136	
	8.2		COMP HT: 1.570 PIN DIA: .9273 Offset	STD. .020 .030 .040 .060		FM H553CP	

AMC/JEEP/EAGLE

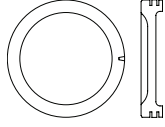
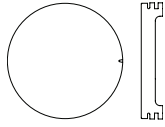
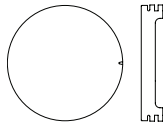
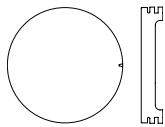
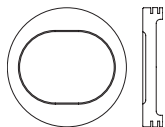
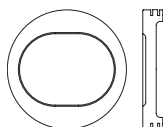
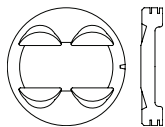
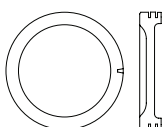
CYL BORE ENGINE	YEAR COMP. RATIO	VIN CODE	NOTES	PART NO. SIZE	RINGS	O.E. ASSY. NO. INTERCHANGE	HEAD SHAPE
L4-151 2.5L 4.0000(IN) 101.6(MM) PONTIAC ENGINE	1981-83 8.2		3.070" dia. head recess .226" deep. Sets only. COMP HT: 1.570 PIN DIA: .9273 Offset	1532 STD. .020 .030 .040 .060	1-1/16 1-5/64 1-3/16 Shallow Groove	10027317 FM 498NP	
V6-173 2.8L 3.5039(IN) 89.0(MM) CHEVY ENGINE	1982-86 8.5		Flat head. 2nd design with 1.5mm top ring. COMP HT: 1.578 PIN DIA: .9055 Offset	1463 STD. .25mm .5mm .75mm 1.0mm 1.5mm	1-1.5mm 1-2.0mm 1-4.75mm	14033250 14003994 FM 464P	
V6-173 2.8L 3.5039(IN) 89.0(MM) CHEVY ENGINE	1982-86 8.5		Flat head. 2nd design with 1.5mm top ring. *Same as 1463 with "COATED SKIRTS". COMP HT: 1.578 PIN DIA: .9055 Offset	1463C STD. .25mm .5mm .75mm 1.0mm 1.5mm	1-1.5mm 1-2.0mm 1-4.75mm	14033250 14003994 FM 464CP	
V6-181 3.0L 3.6614(IN) 93.0(MM) RENAULT ENGINE	1988-92 9.3	U	Flat head COMP HT: 1.510 PIN DIA: .9842 Offset	3215 STD. .5mm .75mm 1.0mm	2-1.75mm 1-3.5mm	J1465756 T1464553	
V6-201 3.3L 3.6614(IN) 93.0(MM) CHRYSLER ENGINE	1990-94 8.9	R T U	SEFI. Oval head recess .090" deep. COMP HT: 1.260 PIN DIA: .9009 Offset	3212 STD. .5mm .75mm 1.0mm	2-1.5mm 1-3.0mm	4556359 4448176 5241057	
V6-201 3.3L 3.6614(IN) 93.0(MM) CHRYSLER ENGINE	1990-94 8.9	R T U	SEFI. Oval head recess .090" deep. *Same as 3212 with "COATED SKIRTS". COMP HT: 1.260 PIN DIA: .9009 Offset	3212C STD. .5mm .75mm 1.0mm	2-1.5mm 1-3.0mm	4556359 4448176 5241057 FM 574CP	
V6-213 3.5L 3.7795(IN) 96.0(MM) CHRYSLER ENGINE	1993-97 10.4	F	Hypereutectic. Dome head .050" high w/4 valve reliefs. For both left and right applica- tions. Full floating pin. "COATED SKIRTS". Not intended for Racing applications. COMP HT: 1.487 PIN DIA: .9449 Offset	3214HC STD. .5mm .75mm 1.0mm 1.5mm	2-1.5mm 1-3.0mm	4638835L 4638836R 4728709R 4728726L FM H697CP	
V6-225 3.7L 3.7500(IN) 95.25(MM) BUICK ENGINE	1966-71 8.3		3.060" dia. head recess .230" deep. COMP HT: 1.835 PIN DIA: .9398 Offset	1748 STD. .020 .030 .040 .060	2-5/64 1-3/16	1395184 FM 279P	

AMC/JEEP/EAGLE

CYL BORE ENGINE	YEAR COMP. RATIO	VIN CODE	NOTES	PART NO. SIZE	RINGS	O.E. ASSY. NO. INTERCHANGE	HEAD SHAPE
L6-226 3.7L 3.3130(IN) 84.1(MM) CONTINENTAL ENGINE	1946-65 7.3		Flat head. COMP HT: 1.980 PIN DIA: .8593 Center	2103 STD. .020 .030 .040 .060	2-3/32 2-5/32	207247 FM 200NP	
L6-226 3.7L 3.3130(IN) 84.1(MM) CONTINENTAL ENGINE	1954-65 7.1		F226 & F227 flat head. COMP HT: 2.000 PIN DIA: .8593 Center	4537 STD. .020 .030 .040 .060	1-5/64 2-3/32 1-1/4	F227A4061E FM 704P	
V6-226 3.7L 3.6614(IN) 93.0(MM) CHRYSLER ENGINE	2002-06 9.1	K	Hypereutectic. Flat Head. Coated skirts. Floating Pin. COMP HT: 1.240 PIN DIA: .9455 Offset	3251HC STD. .5mm .75mm 1.0mm	2-1.5mm 1-3.0mm Shallow Groove	5019316AA	
L6-232 3.8L 3.7500(IN) 95.25(MM) AMC ENGINE	1965-79 8.0		"D" shaped head recess .120" deep. Replace in full sets only. COMP HT: 1.581 PIN DIA: .9310 Offset	2226 STD. .020 .030 .040 .060	2-5/64, 1-3/16	3204957 4488672 8127654 FM 456NP	
V6-239 3.9L 3.9100(IN) 99.3(MM) CHRYSLER ENGINE	1986-02 9.0	M X	Hypereutectic. Flat Head. Not intended for Racing applications. COMP HT: 1.741 PIN DIA: .9842 Offset	3236H STD. .020 .030 .040 .060	2-2.0mm 1-4.0mm Shallow Groove	4778855(L) 4778857(R) FM H696P	
V6-239 3.9L 3.9100(IN) 99.3(MM) CHRYSLER ENGINE	1986-02 9.0	M X	Hypereutectic. Flat head. Coated skirts. COMP HT: 1.741 PIN DIA: .9842 Offset	3236HC STD. .020 .030 .040 .060	2-2.0mm 1-4.0mm Shallow Groove	FM H696CP	
V6-239 3.9L 3.9100(IN) 99.3(MM) CHRYSLER ENGINE	1986-02 9.0		Flat head. Same as 3236 with a early ring pack. COMP HT: 1.741 PIN DIA: .9842 Offset	3246 STD. .020 .030 .040 .060	2-5/64 1-3/16	FM 656P	
L6-242 4.0L 3.8750(IN) 98.4(MM) AMC ENGINE	1987-95 9.2		"D" shaped head recess .100" deep. COMP HT: 1.581 PIN DIA: .9310 Offset	2229 STD. .010 .020 .030 .040 .060	2-5/64 1-3/16	8983500251 FM 677AP	

AMC/JEEP/EAGLE

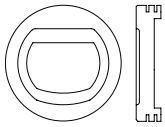
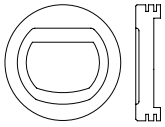
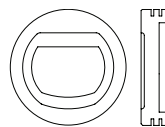
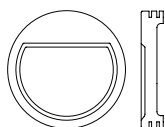
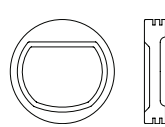
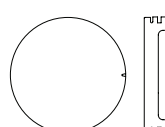
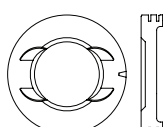
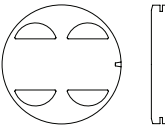
CYL BORE ENGINE	YEAR COMP. RATIO	VIN CODE	NOTES	PART NO. SIZE	RINGS	O.E. ASSY. NO. INTERCHANGE	HEAD SHAPE
L6-242 4.0L 3.8750(IN) 98.4(MM) AMC ENGINE	1987-95 9.2		"D" shaped head recess .100" deep. *Same as 2229 with "COATED SKIRTS". COMP HT: 1.581 PIN DIA: .9310 Offset	2229C STD. .010 .020 .030 .040 .060	2-5/64 1-3/16	8983500251 FM 677ACP	
L6-242 4.0L 3.8750(IN) 98.4(MM) AMC ENGINE	1996-02 8.8	S	Hypereutectic. "D" shaped head recess .116" deep. "COATED SKIRTS". Not intended for Racing applications. COMP HT: 1.592 PIN DIA: .9310 Offset	3241HC STD. .020 .030 .040 .060	2-1.5mm 1-4.0mm Shallow Groove	04798331 FM H802CP	
L6-242 4.0L 3.8750(IN) 98.4(MM) AMC ENGINE	1996-02 8.8		Hypereutectic. "D" shaped head recess .116" deep. "COATED SKIRTS". Not intended for Racing applications. Same as 3241HC with early ring pack COMP HT: 1.592 PIN DIA: .9310 Offset	3242HC STD. .020 .030 .040 .060	2-5/64 1-3/16	FM H825CP	
L6-258 4.2L 3.7500(IN) 95.25(MM) AMC ENGINE	1971-78 8.0		"D" shaped head recess .120" deep. Replace in full sets only. COMP HT: 1.581 PIN DIA: .9310 Offset	2226 STD. .020 .030 .040 .060	2-5/64, 1-3/16	4488672 8127654 3204957 FM 456NP	
L6-258 4.2L 3.7500(IN) 95.25(MM) AMC ENGINE	1979-90 8.2		"D" shaped head recess .185" deep. COMP HT: 1.630 PIN DIA: .9310 Offset	2227 STD. .020 .030 .040 .060	2-5/64, 1-3/16	8130208 8134441 FM 470NP	
V8-287 4.7L 3.6614(IN) 93.0(MM) CHRYSLER ENGINE	1999-06 9.0	N	Hypereutectic. Flat Head. Coated skirts. COMP HT: 1.240 PIN DIA: .9455 Offset	3252HC STD. .5mm .75mm 1.0mm	2-1.5mm 1-3.0mm Shallow Groove	5019316AA FM H883CP	
V8-304 5.0L 3.7500(IN) 95.25(MM) AMC ENGINE	1970-81 8.4		3.320" dia. head recess .130" deep w/4 valve reliefs. COMP HT: 1.581 PIN DIA: .9310 Offset	2234 STD. .020 .030 .040 .060	2-5/64, 1-3/16	4487564 FM 1079P	
V8-318 5.2L 3.9100(IN) 99.3(MM) CHRYSLER ENGINE	1967-94 9.0 8.6 8.4		Flat top w/4 valve reliefs. 1973 and later press fit, no lockrings. 1991 and later use early style rings. COMP HT: 1.741 PIN DIA: .9842 Offset	1266 STD. .020 .030 .040 .060	2-5/64 1-3/16	2808405 3004509 3420222 3685751 4342772 4638072 FM 285NP	

AMC/JEEP/EAGLE

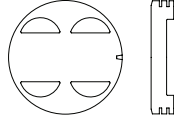
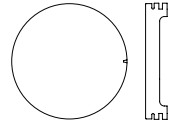
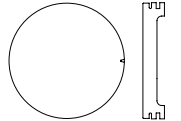
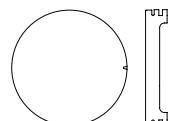
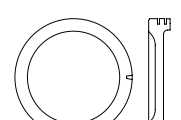
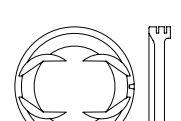
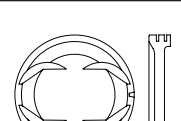
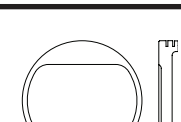
CYL BORE ENGINE	YEAR COMP. RATIO	VIN CODE	NOTES	PART NO. SIZE	RINGS	O.E. ASSY. NO. INTERCHANGE	HEAD SHAPE
V8-318 5.2L 3.9100(IN) 99.3(MM) CHRYSLER ENGINE	1967-84 9.0 8.6 8.4	X Y	Flat top w/4 valve reliefs. 1973 and later press fit. 1991 and later use early style rings. *Same as 1266 with "COATED SKIRTS". COMP HT: 1.741 PIN DIA: .9842 Offset	1266C STD. .020 .030 .040 .060	2-5/64 1-3/16	2808405 3004509 3420222 3685751 4342772 4638072 FM 285NCP	
V8-318 5.2L 3.9100(IN) 99.3(MM) CHRYSLER ENGINE	1985-02 9.0	Y T	Hypereutectic. Flat head. Not intended for Racing applications. COMP HT: 1.741 PIN DIA: .9842 Offset	3234H STD. .020 .030 .040 .060	2-2.0mm 1-4.0mm Shallow Groove	4778855(L) 4778857(R) FM H814P	
V8-318 5.2L 3.9100(IN) 99.3(MM) CHRYSLER ENGINE	1985-02 9.0	Y T	Hypereutectic. Flat head. Coated skirts. COMP HT: 1.741 PIN DIA: .9842 Offset	3234HC STD. .020 .030 .040 .060	2-2.0mm 1-4.0mm Shallow Groove	FM H814CP	
V8-318 5.2L 3.9100(IN) 99.3(MM) CHRYSLER ENGINE	1985-02 9.0		Flat head. Same as 3234 with a early ring pack. COMP HT: 1.741 PIN DIA: .9842 Offset	3247 STD. .020 .030 .040 .060	2-5/64 1-3/16	FM 526AP	
V8-350 5.7L 3.8000(IN) 96.52(MM) BUICK ENGINE	1968-71		3.050" dia. head recess .215" deep. COMP HT: 1.805 PIN DIA: .9398 Offset	1746 STD. .020 .030 .040 .060	2-5/64 1-3/16	1249538 FM 657P	
V8-360 5.9L 4.0800(IN) 103.6(MM) AMC ENGINE	1970-91 9.0		3.600" dia. head recess .190" deep w/4 valve reliefs. COMP HT: 1.580 PIN DIA: .9310 Offset	2225 STD. .020 .030 .040 .060	2-5/64, 1-3/16	4487567 8133807 FM 362NP	
V8-360 5.9L 4.0800(IN) 103.6(MM) AMC ENGINE	1970-91 9.0		3.600" dia. head recess .190" deep w/4 valve reliefs. *Same as 2225 with "COATED SKIRTS". COMP HT: 1.580 PIN DIA: .9310 Offset	2225C STD. .020 .030 .040 .060	2-5/64, 1-3/16	4487567 8133807 FM 362NCP	
V8-360 5.9L 4.0000(IN) 101.6(MM) CHRYSLER ENGINE	1993-01 9.0	5 Z	Rectangular head recess .080" deep COMP HT: 1.605 PIN DIA: .9842 Offset	3222 STD. .020 .030 .040 .060	2-1.5mm 1-4.0mm	4713879 4778871 4762950 4740255	

AMC/JEEP/EAGLE

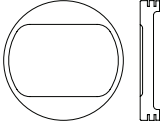
CYL BORE ENGINE	YEAR COMP. RATIO	VIN CODE	NOTES	PART NO. SIZE	RINGS	O.E. ASSY. NO. INTERCHANGE	HEAD SHAPE
V8-360 5.9L 4.0000(IN) 101.6(MM) CHRYSLER ENGINE	1993-01	5 Z	Hypereutectic. Rectangular head recess .080" deep. "COATED SKIRTS". Not intended for Racing applications.	3222HC	2-1.5mm 1-4.0mm	4713879 4778871 4762950 4740255	
	9.0	COMP HT: 1.605 PIN DIA: .9842 Offset	STD. .020 .030 .040 .060	FM H655CP			

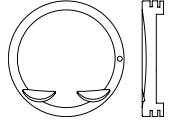
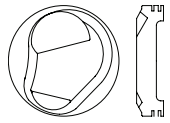
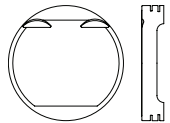
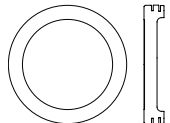
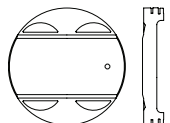
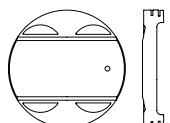
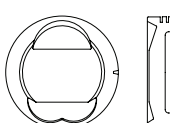
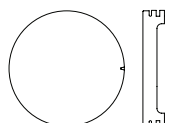

CHRYSLER

CYL BORE ENGINE	YEAR COMP. RATIO	VIN CODE	NOTES	PART NO. SIZE	RINGS	O.E. ASSY. NO. INTERCHANGE	HEAD SHAPE
L4-090 1.5L 2.9724(IN) 75.5(MM) MITSUBISHI ENGINE	1991-95 9.2	A	Hypereutectic. 2.560" dia. head recess .020" deep w/2 valve reliefs. Not intended for Racing applications. COMP HT: 1.133 PIN DIA: .7090 Offset	3213H STD. .5mm .75mm 1.0mm	1-1.2mm 1-1.5mm 1-3.0mm	MD144901 FM H13130P	
L4-110 1.8L 3.1732(IN) 80.6(MM) MITSUBISHI ENGINE	1989-94 9.0	B C	4G37 Engine. Dome head .150" high w/2 valve reliefs COMP HT: 1.320 PIN DIA: .7485 Offset	3216 STD. .5mm .75mm 1.0mm	2-1.5mm 1-4.0mm	MD100416	
L4-110 1.8L 3.1890(IN) 81.0(MM) MITSUBISHI ENGINE	1990-94 9.5	B C	16 Valve SOHC. 113 HP. Dome head .010" high w/2 valve reliefs. COMP HT: 1.210 PIN DIA: .7480 Offset	3220 STD. .5mm .75mm 1.0mm	2-1.2mm 1-2.8mm	MD190610 MD183457 MD174995	
L4-122 2.0L 3.4449(IN) 87.5(MM) CHRYSLER ENGINE	1995-04 9.8	C N	Hypereutectic. SOHC. 2.600" dia. head recess .015" deep. "COATED SKIRTS". Not intended for Racing applications. COMP HT: 1.230 PIN DIA: .8267 Offset	3229HC STD. .5mm .75mm 1.0mm	2-1.2mm 1-3.0mm Shallow Groove	4773975 FM H852CP	
L4-122 2.0L 3.4449(IN) 87.5(MM) CHRYSLER ENGINE	1996-99 9.6	Y	DOHC. Dome head .035" high w/4 valve reliefs COMP HT: 1.230 PIN DIA: .8267 Offset	3228 STD. .5mm .75mm 1.0mm	2-1.2mm 1-3.0mm Shallow Groove	4741372 4797613	
L4-122 2.0L 3.4449(IN) 87.5(MM) CHRYSLER ENGINE	1996-99 9.6	Y	Hypereutectic. DOHC. Dome head .035" high w/4 valve reliefs. "COATED SKIRTS". Not intended for Racing applications. COMP HT: 1.230 PIN DIA: .8267 Offset	3228HC STD. .5mm .75mm 1.0mm	2-1.2mm 1-3.0mm Shallow Groove	4741372 4797613 FM H853CP	
L4-122 2.0L 3.3465(IN) 85.0(MM) MITSUBISHI ENGINE	1983-92 8.5	V	G63B, 4G63 SOHC engine. 2.500" dia. head recess .050" deep w/3 valve reliefs. Use late model ring set. COMP HT: 1.360 PIN DIA: .8267 Offset	3217 STD. .5mm .75mm 1.0mm	2-1.5mm 1-4.0mm Late Style	MD040591 MD100372 FM 13168P	
L4-135 2.2L 3.4449(IN) 87.5(MM) CHRYSLER ENGINE	1981-86 8.5 9.0		E62 engine. Flat head. COMP HT: 1.570 PIN DIA: .9009 Offset	1287 STD. .5mm .75mm 1.0mm 1.5mm	2-1.5mm 1-4.0mm Shallow Groove	4240099 4271929 FM 524P	

CHRYSLER

CYL BORE ENGINE	YEAR COMP. RATIO	VIN CODE	NOTES	PART NO. SIZE	RINGS	O.E. ASSY. NO. INTERCHANGE	HEAD SHAPE
L4-135 2.2L 3.4449(IN) 87.5(MM) CHRYSLER ENGINE	1984-85 8.5		Hypereutectic. Turbo. 2.200" dia. head recess .190" deep. Not intended for Racing applications. COMP HT: 1.571 PIN DIA: .9012 Offset	1290H STD. .5mm .75mm 1.0mm 1.5mm	2-1.5mm 1-4.0mm Shallow Groove	4271927 FM 532P	
L4-135 2.2L 3.4449(IN) 87.5(MM) CHRYSLER ENGINE	1986-90 8.0		Hypereutectic. Turbo. 2.600" dia. head recess .190" deep w/2 valve reliefs. Lock-rings included. Not intended for Racing applications. COMP HT: 1.571 PIN DIA: .9009 Offset	1291H STD. .5mm .75mm 1.0mm 1.5mm	2-1.5mm 1-4.0mm Shallow Groove	4397634 4387512 5241059 FM 533P	
L4-135 2.2L 3.4449(IN) 87.5(MM) CHRYSLER ENGINE	1986-94 9.0 9.6 9.5	D	Non-turbo. All Fuel Injected. Carb. Omni and Horizon. Trench valve relief. COMP HT: 1.571 PIN DIA: .9009 Offset	1293 STD. .5mm .75mm 1.0mm 1.5mm	2-1.5mm 1-4.0mm	4397632 4626119 4626120 4798470 FM 527P	
L4-143 2.4L 3.4055(IN) 86.5(MM) MITSUBISHI ENGINE	1989-92 8.5	W G	Flat head w/3 valve reliefs. COMP HT: 1.370 PIN DIA: .8267 Offset	3225 STD. .5mm .75mm 1.0mm	2-1.5mm 1-4.0mm	MD105377 FM 12958P	
L4-143 2.4L 3.4055(IN) 86.5(MM) MITSUBISHI ENGINE	1993-96 9.5	G	4G64 Engine. 3.100" dia. head recess .160" deep COMP HT: 1.360 PIN DIA: .8665 Offset	3221 STD. .5mm .75mm 1.0mm	1-1.2mm 1-1.5mm 1-2.8mm	MD303071 MD188115	
L4-146 2.4L 3.4449(IN) 87.5(MM) CHRYSLER ENGINE	1998-00 9.0	B X 1	DOHC 16 Valve. Dome head .256" high w/3 valve reliefs. COMP HT: 1.188 PIN DIA: .8665 Offset	3233 STD. .5mm .75mm 1.0mm	1-1.2mm 1-1.5mm 1-3.0mm	4897660AA	
L4-146 2.4L 3.4449(IN) 87.5(MM) CHRYSLER ENGINE	2001-08 9.5	B X PT Crusier 1	Hypereutectic. .450" high dome w/2 valve reliefs. Coated skirts. COMP HT: 1.179 PIN DIA: .8665 Offset	3249HC STD. .5mm .75mm 1.0mm	2-1.5mm 1-3.0mm Shallow Groove	5142303AA	
L4-146 2.4L 3.4449(IN) 87.5(MM) CHRYSLER ENGINE	2004-06 8.1	E G	Hypereutectic. .450" high dome. Turbocharged. Coated skirts. COMP HT: 1.092 PIN DIA: .8661 Offset	3250HC STD. .5mm .75mm 1.0mm	1-1.2mm 1-1.5mm 1-2.5mm Shallow Groove	4884247AD	

CHRYSLER

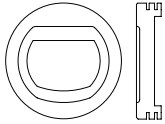
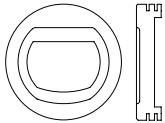
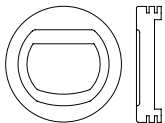
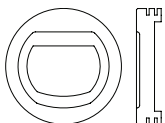
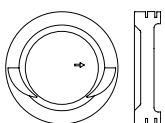
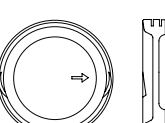
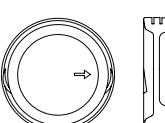
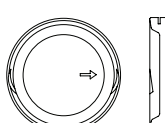
CYL BORE ENGINE	YEAR COMP. RATIO	VIN CODE	NOTES	PART NO. SIZE	RINGS	O.E. ASSY. NO. INTERCHANGE	HEAD SHAPE
L4-151 2.5L 3.8750(IN) 98.4(MM) AMC ENGINE	1983-95 9.2	U	"D" shaped head recess .100" deep. COMP HT: 1.581 PIN DIA: .9310 Offset	2228 STD. .010 .020 .030 .040 .060	2-5/64 1-3/16	8983500251 FM 525AP	
L4-151 2.5L 3.8750(IN) 98.4(MM) AMC ENGINE	1983-95 9.2	U	"D" shaped head recess .100" deep. *Same as 2228 with "COATED SKIRTS". COMP HT: 1.581 PIN DIA: .9310 Offset	2228C STD. .010 .020 .030 .040 .060	2-5/64 1-3/16	8983500251 FM 525ACP	
L4-151 2.5L 3.8750(IN) 98.4(MM) AMC ENGINE	1996-02 9.1	P	Hypereutectic. "D" shaped head recess .116" deep. "COATED SKIRTS". Not intended for Racing applications. COMP HT: 1.592 PIN DIA: .9310 Offset	3238HC STD. .020 .030 .040 .060	2-1.5mm 1-4.0mm Shallow Groove	04798331 FM H822CP	
L4-151 2.5L 3.8750(IN) 98.4(MM) AMC ENGINE	1996-02 9.1		Hypereutectic. "D" shaped head recess .116" deep. "COATED SKIRTS". Not intended for Racing applications. Same as 3238HC w/early ring pack. COMP HT: 1.592 PIN DIA: .9310 Offset	3243HC STD. .020 .030 .040 .060	2-5/64 1-3/16	FM H823CP	
L4-153 2.5L 3.4449(IN) 87.5(MM) CHRYSLER ENGINE	1986-88 9.0		Non-turbo. Non-EFI. 2.640" dia. head recess .160" deep w/2 valve reliefs. COMP HT: 1.571 PIN DIA: .9009 Offset	1292 STD. .5mm .75mm 1.0mm 1.5mm	2-1.5mm 1-4.0mm	4397636 FM H533P	
L4-153 2.5L 3.4449(IN) 87.5(MM) CHRYSLER ENGINE	1989-94 7.8		Hypereutectic. Turbo. 2.800" dia. head recess .300" deep w/2 valve reliefs. Full floating pin. Not intended for Racing applications. COMP HT: 1.335 PIN DIA: .9009 Offset	3223H STD. .5mm .75mm 1.0mm	2-1.5mm 1-4.0mm Shallow Groove	4637763 4637664 FM H579P	
L4-153 2.5L 3.4449(IN) 87.5(MM) CHRYSLER ENGINE	1989-95 8.9	K P W Z	Non-turbo. 3.070" dia. head recess .135" deep w/2 valve reliefs. Press fit pin. COMP HT: 1.350 PIN DIA: .9009 Offset	3211 STD. .5mm .75mm 1.0mm 1.5mm	2-1.5mm 1-4.0mm Shallow Groove	4494479 5241055 4728945 4728947 4773035 4773039 4773037 5241092 FM 571P	
L4-153 2.5L 3.4449(IN) 87.5(MM) CHRYSLER ENGINE	1989-95 8.9	K P W Z	Non-turbo. 3.070" dia. head recess .135" deep w/2 valve reliefs. Press fit pin. *Same as 3211 with "COATED SKIRTS". COMP HT: 1.350 PIN DIA: .9009 Offset	3211C STD. .5mm .75mm 1.0mm 1.5mm	2-1.5mm 1-4.0mm Shallow Groove	4494479 5241055 4728945 4728947 4773035 4773039 4773037 5241092 FM 571CP	

CHRYSLER

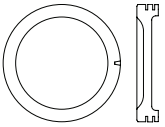
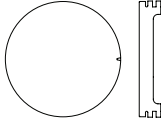
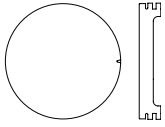
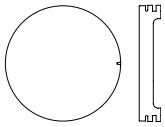
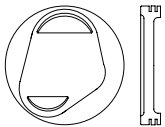
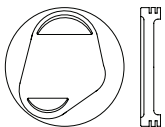
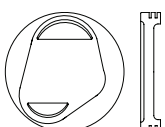
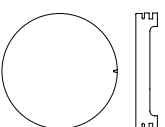
CYL BORE ENGINE	YEAR COMP. RATIO	VIN CODE	NOTES	PART NO. SIZE	RINGS	O.E. ASSY. NO. INTERCHANGE	HEAD SHAPE
L4-156 2.6L 3.5866(IN) 91.1(MM) MITSUBISHI ENGINE	1976-87 1984-89 8.2	F W	Hypereutectic. 2.800" dia. head recess .200" deep. 1976-87 Non-Turbo, 1984- 87 EFI, 1984-89 Turbo. Not intended for Racing applications. COMP HT: 1.365 PIN DIA: .8665 Offset	3210H STD. .5mm .75mm 1.0mm	2-1.5mm 1-4.0mm	Non-turbo: MD024947 MD026861 MD061248 MD128450 Turbo: MD061248 MD128450 FM 12220P	
L4-156 2.6L 3.5866(IN) 91.1(MM) MITSUBISHI ENGINE	1981-89 8.2		Hypereutectic. Flat head. Not intended for Racing applications. COMP HT: 1.418 PIN DIA: .8665 Offset	1288H STD. .5mm .75mm 1.0mm 1.5mm	2-1.5mm 1-4.0mm	MD071172 MD026921 FM H605P	
V6-167 2.7L 3.3859(IN) 86.002(MM) CHRYSLER ENGINE	1998-04 9.7	R	Hypereutectic. Flat Head. Not intended for Racing applications. "COATED SKIRTS". COMP HT: 1.220 PIN DIA: .8661 Offset	3235HC STD. .25mm .5mm .75mm 1.0mm	2-1.5mm 1-3.0mm Shallow Groove	5018627AB FM H862CP	
L6-170 2.8L 3.4000(IN) 86.4(MM) CHRYSLER ENGINE	1960-69 8.7		Flat head. COMP HT: 1.740 PIN DIA: .9012 Offset	1250 STD. .020 .030 .040 .060	2-5/64 1-3/16	2084384 FM 244NP	
V6-181 3.0L 3.5866(IN) 91.1(MM) MITSUBISHI ENGINE	1987-93 8.85	H B S	6G72 Engine. SOHC. Triangular head recess .098" deep w/2 valve reliefs. Centered pin. COMP HT: 1.247 PIN DIA: .8665 Centered	3201 STD. .5mm .75mm 1.0mm	2-1.5mm 1-4.0mm	MD119671R MD152563L FM 6678P	
V6-181 3.0L 3.5866(IN) 91.1(MM) MITSUBISHI ENGINE	1987-93 8.85	H B S	Hypereutectic. Triangular head recess .098" deep w/2 valve reliefs. "COATED SKIRTS". Not intended for Racing applications. COMP HT: 1.247 PIN DIA: .8665 Offset	3201HC STD. .5mm .75mm 1.0mm	2-1.5mm 1-4.0mm	FM H834CP	
V6-181 3.0L 3.5866(IN) 91.1(MM) MITSUBISHI ENGINE	1992-00 8.85		Hypereutectic. 6G72 and 6G72S SOHC Engines. Triangular head recess .125" deep w/2 valve reliefs. "COATED SKIRTS". Not intended for Racing applications. COMP HT: 1.247 PIN DIA: .8665 Offset	3224HC STD. .5mm .75mm 1.0mm	1-1.2mm 1-1.5mm 1-3.0mm	FM 694CP	
V6-181 3.0L 3.6614(IN) 93.0(MM) RENAULT ENGINE	1988-92 9.3	U	Flat head COMP HT: 1.510 PIN DIA: .9842 Offset	3215 STD. .5mm .75mm 1.0mm	2-1.75mm 1-3.5mm	J1465756 T1464553	

CHRYSLER

CYL BORE ENGINE	YEAR COMP. RATIO	VIN CODE	NOTES	PART NO. SIZE	RINGS	O.E. ASSY. NO. INTERCHANGE	HEAD SHAPE
L6-198 3.2L 3.4000(IN) 86.4(MM) CHRYSLER ENGINE	1970-74 8.2		Flat head. COMP HT: 1.740 PIN DIA: .9012 Offset	1250 STD. .020 .030 .040 .060	2-5/64 1-3/16	2084384 FM 244NP	
V6-201 3.3L 3.6614(IN) 93.0(MM) CHRYSLER ENGINE	1990-97 8.9		SEFI. Oval head recess .090" deep. COMP HT: 1.260 PIN DIA: .9009 Offset	3212 STD. .5mm .75mm 1.0mm	2-1.5mm 1-3.0mm	5241057 4448176 (ASSEMBLY ROD & PISTON 4556359)	
V6-201 3.3L 3.6614(IN) 93.0(MM) CHRYSLER ENGINE	1990-97 8.9		SEFI. Oval head recess .090" deep. *Same as 3212 with "COATED SKIRTS". COMP HT: 1.260 PIN DIA: .9009 Offset	3212C STD. .5mm .75mm 1.0mm	2-1.5mm 1-3.0mm	5241057 4448176 (ASSEMBLY ROD & PISTON 4556359) FM 574CP	
V6-201 3.3L 3.6614(IN) 93.0(MM) CHRYSLER ENGINE	2000-02 8.9	G R	Flat Head. "COATED SKIRTS". COMP HT: 1.173 PIN DIA: .9009 Offset	3230C STD. .5mm .75mm 1.0mm	2-1.5mm 1-3.0mm Shallow Groove	4897772AA FM 866CP	
V6-213 3.5L 3.7795(IN) 96.0(MM) CHRYSLER ENGINE	1993-97 10.4	F	Hypereutectic. Dome head .050" high w/4 valve reliefs. For both left and right applications. Full floating pin. "COATED SKIRTS". Not intended for Racing applications. COMP HT: 1.487 PIN DIA: .9449 Offset	3214HC STD. .5mm .75mm 1.0mm 1.5mm	2-1.5mm 1-3.0mm	4638835L 4638836R 4728709R 4728726L 4883222R 4883223L FM H697CP	
V6-215 3.5L 3.7795(IN) 96.0(MM) CHRYSLER ENGINE	1996-97 10.45	F	Hypereutectic. Dome head .032" high w/4 valve reliefs. "COATED SKIRTS". Not intended for Racing applications. COMP HT: 1.496 PIN DIA: .9449 Offset	3239HC STD. .5mm .75mm 1.0mm	1-1.2mm 1-1.5mm 1-3.0mm	4.88322e+006 FM H842CP	
V6-214 3.5L 3.7795(IN) 96.0(MM) CHRYSLER ENGINE	1999-06	G M K V	Hypereutectic, Dish 2.800" Diameter, .022" Deep "COATED SKIRTS" .040 Offset Floating Pin COMP. HT: 1.492 PIN DIA: .9449	3255HC STD. .25mm .5mm .75mm 1.0mm	1-1.2mm 1-1.5mm 1-3.0mm	5010335AB T271 CASTING FM H1121CP	
L6-218 3.6L 3.2500(IN) 82.6(MM) CHRYSLER ENGINE	1942-54 7.8		Flat head. Floating Pin. COMP HT: 1.978 PIN DIA: .8593 Center	1280 STD. .020 .030 .040 .060 .080	2-3/32 2-5/32	1241622 2084339 FM 37P	

CHRYSLER

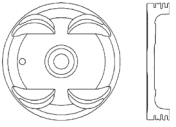
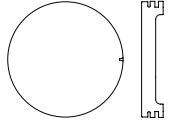
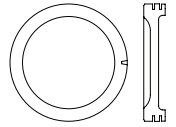
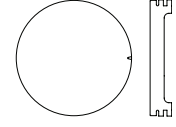
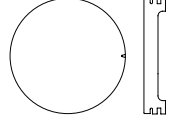
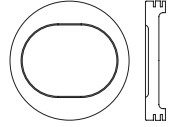
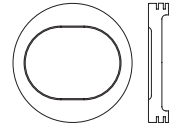
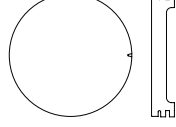
CYL BORE ENGINE	YEAR COMP. RATIO	VIN CODE	NOTES	PART NO. SIZE	RINGS	O.E. ASSY. NO. INTERCHANGE	HEAD SHAPE
V6-218 3.6L 3.7790(IN) 96.0(MM) CHRYSLER ENGINE	2011-19 10.2		Hypereutectic Alloy. Anodized Crown and Top Ring Groove. Floating Pin. COMP HT: 1.165 PIN DIA: .866 Offset	3262HCA STD. .25 .50 .75		224-3855WR	
L6-225 3.7L 3.4000(IN) 86.4(MM) CHRYSLER ENGINE	1960-87 8.2		Flat head. Cars through 1983. Trucks through 1987. COMP HT: 1.740 PIN DIA: .9012 Offset	1250 STD. .020 .030 .040 .060	2-5/64 1-3/16	2084384 FM 244NP	
L6-225 3.7L 3.4000(IN) 86.4(MM) CHRYSLER ENGINE	1960-87 7.0		2.500" dia. Head recess .210" deep. Low compression. COMP HT: 1.760 PIN DIA: .9012 Offset	1294 STD. .020 .030 .040 .060	2-5/64 1-3/16	FM LC244P	
V6-226 3.7L 3.6614(IN) 93.0(MM) CHRYSLER ENGINE	2002-06 9.1	K	Hypereutectic. Flat head. Coated skirts. Floating Pin. COMP HT: 1.240 PIN DIA: .9455 Offset	3251HC STD. .5mm .75mm 1.0mm	2-1.5mm 1-3.0mm Shallow Groove	5019316AA	
L6-230 3.8L 3.2500(IN) 82.6(MM) CHRYSLER ENGINE	1934-60 7.8		Flat head. COMP HT: 1.978 PIN DIA: .8593 Center	1280 STD. .020 .030 .040 .060 .080	2-3/32 2-5/32	1241622 2084339 FM 37P	
V6-230 3.8L 3.7795(IN) 96.0(MM) CHRYSLER ENGINE	1991-99 9.0	L R T	Oval head recess .192" deep. COMP HT: 1.369 PIN DIA: .9009 Offset	3209 STD. .5mm .75mm 1.0mm	2-1.5mm 1-3.0mm	4556360	
V6-230 3.8L 3.7795(IN) 96.0(MM) CHRYSLER ENGINE	1991-99 9.0	L R T	Oval head recess .192" deep. *Same as 3209 with "COATED SKIRTS". COMP HT: 1.369 PIN DIA: .9009 Offset	3209C STD. .5mm .75mm 1.0mm	2-1.5mm 1-3.0mm	4556360 FM 803CP	
V6-230 3.8L 3.7795(IN) 96.0(MM) CHRYSLER ENGINE	2000-03 9.6	L	Flat head. "COATED SKIRTS". COMP HT: 1.283 PIN DIA: .9009 Offset	3245C STD. .5mm .75mm 1.0mm	2-1.5mm 1-3.0mm Shallow Groove	5019338AA	



CHRYSLER

CYL BORE ENGINE	YEAR COMP. RATIO	VIN CODE	NOTES	PART NO. SIZE	RINGS	O.E. ASSY. NO. INTERCHANGE	HEAD SHAPE
V6-230 3.8L 3.7800(IN) 96.01(MM) CHRYSLER ENGINE	2007-13 9.6:1	L P 1	Flat Top Hypereutectic with Coated Skirts Press Pin COMP HT: 1.261 PIN DIA: .9009 Offset	3259HC STD. .5mm .75mm 1.0mm	1.2mm 1.5mm 3.0mm	0466 6129AA OE Casting 04781	
L6-237 3.9L 3.4370(IN) 87.3(MM) CHRYSLER ENGINE	1942-51 6.9		Flat head. COMP HT: 1.978 PIN DIA: .8593 Center	1281 STD. .020 .030 .040 .060	2-3/32 2-5/32	1326094 1241646 FM 32NP	
V6-239 3.9L 3.9100(IN) 99.3(MM) CHRYSLER ENGINE	1986-02 9.0	M X	Hypereutectic. Flat Head. Not intended for Racing applications. COMP HT: 1.741 PIN DIA: .9842 Offset	3236H STD. .020 .030 .040 .060	2-2.0mm 1-4.0mm Shallow Groove	4778855(L) 4778857(R) FM H696P	
V6-239 3.9L 3.9100(IN) 99.3(MM) CHRYSLER ENGINE	1986-02 9.0	M X	Hypereutectic. Flat head. Coated skirts. COMP HT: 1.741 PIN DIA: .9842 Offset	3236HC STD. .020 .030 .040 .060	2-2.0mm 1-4.0mm Shallow Groove	FM H696CP	
V6-239 3.9L 3.9100(IN) 99.3(MM) CHRYSLER ENGINE	1986-02 9.0		Flat head. Same as 3236 with a early ring pack. COMP HT: 1.741 PIN DIA: .9842 Offset	3246 STD. .020 .030 .040 .060	2-5/64 1-3/16	FM 656P	
L6-251 4.1L 3.4370(IN) 87.3(MM) CHRYSLER ENGINE	1942-54 6.9		Flat head. COMP HT: 1.978 PIN DIA: .8593 Center	1281 STD. .020 .030 .040 .060	2-3/32 2-5/32	1241646 1326094 FM 32NP	
L6-264 4.3L 3.4370(IN) 87.3(MM) CHRYSLER ENGINE	1952-60 6.9		Flat head. COMP HT: 1.978 PIN DIA: .8593 Center	1281 STD. .020 .030 .040 .060	2-3/32 2-5/32	1326094 1241646 FM 32NP	
V8-287 4.7L 3.6614(IN) 93.0(MM) CHRYSLER ENGINE	1999-09 9.0	N P	Hypereutectic. Flat head. Coated skirts. Floating pin. COMP HT: 1.240 PIN DIA: .9455 Offset	3252HC STD. .5mm .75mm 1.0mm	2-1.5mm 1-3.0mm Shallow Groove	5019316AA 53021008 FM H883CP	

CHRYSLER

CYL BORE ENGINE	YEAR COMP. RATIO	VIN CODE	NOTES	PART NO. SIZE	RINGS	O.E. ASSY. NO. INTERCHANGE	HEAD SHAPE
V8-287 4.7L 3.6614 93(MM) CHRYSLER ENGINE	2002-04	J	Hypereutectic Dome 2.480" high by .081" tall. Floating Pin "COATED SKIRTS" Powertech WJ COMP HT: 1.240 PIN DIA: .945 Offset	3261HC STD. .50mm .75mm 1.0mm	1-1.5mm 1-1.5mm 1-3.0mm Shallow Oil Groove	H1103CP	
V8-318 5.2L 3.9100(IN) 99.3(MM) CHRYSLER ENGINE	1963-78 8.0 7.8		Truck premium engine. Flat head. Floating pin. COMP HT: 1.658 PIN DIA: .9842 Offset	1278 STD. .020 .030 .040 .060	2-5/64 1-3/16	2525000 2808519 3004551 3004555 2808650 FM LC371P	
V8-318 5.2L 3.9100(IN) 99.3(MM) CHRYSLER ENGINE	1967-84 9.0 8.6 8.4	X Y	Flat top w/4 valve reliefs. 1973 and later press fit. 1991 and later use early style rings. Floating pin. COMP HT: 1.741 PIN DIA: .9842 Offset	1266 STD. .020 .030 .040 .060	2-5/64 1-3/16	2808405 3004509 3420222 3685751 4342772 4638072 FM 285NP	
V8-318 5.2L 3.9100(IN) 99.3(MM) CHRYSLER ENGINE	1967-84 9.0 8.6 8.4	X Y	Flat top w/4 valve reliefs. 1973 and later press fit. 1991 and later use early style rings. *Same as 1266 with "COATED SKIRTS". Floating pin. COMP HT: 1.741 PIN DIA: .9842 Offset	1266C STD. .020 .030 .040 .060	2-5/64 1-3/16	2808405 3004509 3420222 3685751 4342772 4638072 FM 285NCP	
V8-318 5.2L 3.9100(IN) 99.3(MM) CHRYSLER ENGINE	1985-02 9.0	Y T	Hypereutectic. Flat head. Not intended for Racing applications. COMP HT: 1.741 PIN DIA: .9842 Offset	3234H STD. .020 .030 .040 .060	2-2.0mm 1-4.0mm Shallow Groove	4778855(L) 4778857(R) FM H814P	
V8-318 5.2L 3.9100(IN) 99.3(MM) CHRYSLER ENGINE	1985-02 9.0	Y T	Hypereutectic. Flat head. Coated skirts. COMP HT: 1.741 PIN DIA: .9842 Offset	3234HC STD. .020 .030 .040 .060	2-2.0mm 1-4.0mm Shallow Groove	FM H814CP	
V8-318 5.2L 3.9100(IN) 99.3(MM) CHRYSLER ENGINE	1985-02 9.0		Flat head. Same as 3234 with a early ring pack. COMP HT: 1.741 PIN DIA: .9842 Offset	3247 STD. .020 .030 .040 .060	2-5/64 1-3/16	FM 526AP	
V8-323 5.3L 3.2500(IN) 82.6(MM) CHRYSLER ENGINE	1942-50 7.1		Flat head. COMP HT: 1.978 PIN DIA: .8593 Center	3244 STD. .020 .030 .040 .060	2-3/32 2-5/32	2084339 FM 37P	

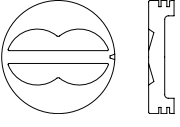
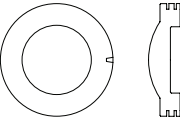
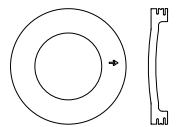
CHRYSLER

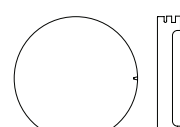
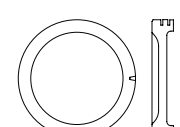
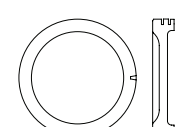
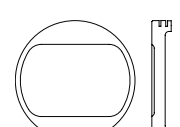
CYL BORE ENGINE	YEAR COMP. RATIO	VIN CODE	NOTES	PART NO. SIZE	RINGS	O.E. ASSY. NO. INTERCHANGE	HEAD SHAPE
V8-340 5.6L 4.0400(IN) 102.6(MM) CHRYSLER ENGINE	1968-71 10.2	H J P	Flat head w/4 valve reliefs. Piston may be used in either left or right cylinder bank. Floating pin. COMP HT: 1.824 PIN DIA: .9842 Offset	1267 STD. .020 .030 .040 .060	2-5/64 1-3/16	3004516-7 FM 428P	
V8-345 5.7L 3.9173(IN) 99.5(MM) CHRYSLER ENGINE	2002-06 9.6	D	Hypereutectic. Hemi engine. .158" high spherical dome. Coated skirts. Press Pin. COMP HT: 1.211 PIN DIA: .9449 Offset	3248HC STD. .5mm .75mm 1.0mm	2-1.5mm 1-3.0mm Shallow Groove	05086011AB FM H899CT	
V8-345 5.7L 3.9173(IN) 99.5(MM) CHRYSLER HEMI ENGINE	2009-11	T	Hypereutectic with ANODIZED CROWN AND TOP RING GROOVE . .092" spherical Hemi dome. Press Pin. "COATED SKIRTS" COMP HT: 1.190 PIN DIA: .945 Offset	3257HCA STD. .5mm .75mm 1.0mm	1.2mm 1.2mm 2.0mm Shallow Groove	5302 2257AD 5302 2257AE	
V8-345 5.7L 3.9173 99.5(MM) CHRYSLER ENGINE	2009-11	T	Hypereutectic with ANODIZED CROWN AND TOP LAND . .092" spherical Hemi dome. FLOATING PIN "Coated Skirts" COMP HT: 1.190 PIN DIA: .945 Offset	3260HCA STD. .50mm .75mm 1.0mm	1-1.2mm 1-1.2mm 1-2.0mm		
V8-360 5.9L 4.0000(IN) 101.6(MM) CHRYSLER ENGINE	1971-81 9.0		Flat head. COMP HT: 1.576 PIN DIA: .9842 Offset	1273 STD. .020 .030 .040 .060	2-5/64 1-3/16	3549366	
V8-360 5.9L 4.0000(IN) 101.6(MM) CHRYSLER ENGINE	1971-94 8.0 8.4		3.130" dia. head recess .05" deep. Thru 1992 trucks. COMP HT: 1.576 PIN DIA: .9842 Offset	1279 STD. .020 .030 .040 .060	2-5/64 1-3/16	3549366 3685737 3780071 4026451 4494480 FM 405P	
V8-360 5.9L 4.0000(IN) 101.6(MM) CHRYSLER ENGINE	1971-94 8.0 8.4		Hypereutectic. 3.130" dia. head recess .050" deep. Coated skirts. COMP HT: 1.576 PIN DIA: .9842 Offset	1279HC STD. .020 .030 .040 .060	2-5/64 1-3/16	FM H405CP	
V8-360 5.9L 4.0000(IN) 101.6(MM) CHRYSLER ENGINE	1993-01 9.0	5 Z	Rectangular head recess .080" deep. COMP HT: 1.605 PIN DIA: .9842 Offset	3222 STD. .020 .030 .040 .060	2-1.5mm 1-4.0mm	4713879 4740255 4762950 4778871,2,3 4778874,5,6	

3260HCA - 5.7L Hemi. Same as 3257HCA but with floating pin.

CHRYSLER

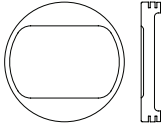
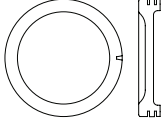
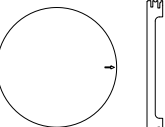
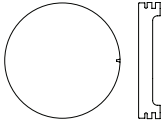
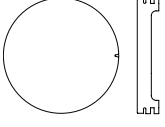
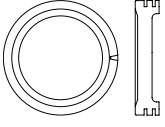
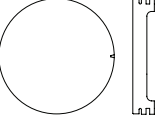
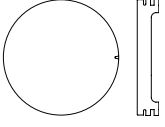
CYL BORE ENGINE	YEAR COMP. RATIO	VIN CODE	NOTES	PART NO. SIZE	RINGS	O.E. ASSY. NO. INTERCHANGE	HEAD SHAPE
V8-360 5.9L 4.0000(IN) 101.6(MM) CHRYSLER ENGINE	1993-01 9.0	5 Z	Hypereutectic. Rectangular head recess .080" deep. "COATED SKIRTS". Not intended for Racing applications. COMP HT: 1.605 PIN DIA: .9842 Offset	3222HC STD. .020 .030 .040 .060	2-1.5mm 1-4.0mm	4713879 4778871 4762950 4740255 FM H655CP	
V8-361 5.9L 4.1250(IN) 104.8(MM) CHRYSLER ENGINE	1960-77 7.5		2.960" dia. head recess .110" deep. Truck engine. COMP HT: 1.880 PIN DIA: 1.094 Center	3219D STD. .020 .030 .040 .060	2-3/32 1-3/16 Iron Top Groove	2084357 FM H251P	
V8-372 6.1L 4.0551(IN) 103(MM) CHRYSLER HEMI ENGINE	2005-10 10.3:1	W	Hypereutectic with ANODIZED CROWN AND TOP RING GROOVE Hemi flat top with no valve reliefs. Floating Pin. "COATED SKIRTS" COMP HT: 1.220 PIN DIA: .984 Offset	3258HCA STD. .25mm .5mm .75mm 1.0mm	1.5mm 1.5mm 3.0mm	68031890AD 376AD	
V8-383 6.3L 4.2500(IN) 108.0(MM) CHRYSLER ENGINE	1959-71 9.5 8.4 8.7	H L H G	Flat head. Not destroyed when used in 1971 engines. COMP HT: 1.848 PIN DIA: 1.094 Offset	1271 STD. .020 .030 .040 .060	2-5/64 1-3/16	1879333 2525433 3004524 3004531 3420210 3420206 FM 366NP	
V8-400 6.6L 4.3420(IN) 110.3(MM) CHRYSLER ENGINE	1972-80 8.0	P N M	Flat head. COMP HT: 1.812 PIN DIA: 1.094 Offset	1274 STD. .020 .030 .040 .060	2-5/64 1-3/16	3621356 FM 406AP	
V8-413 6.8L 4.1880(IN) 106.4(MM) CHRYSLER ENGINE	1960-77 7.5		3.250" dia. head recess .220" deep. Truck engine. COMP HT: 2.023 PIN DIA: 1.094 Center	1272D STD. .020 .030 .040 .060	2-3/32 1-3/16 Iron Top Groove	2084361 3004779 FM H254P	
V8-440 7.2L 4.3200(IN) 109.7(MM) CHRYSLER ENGINE	1966-71 9.5 8.8		Flat head piston replacing both flat head and dished O.E. pistons. COMP HT: 1.969 PIN DIA: 1.094 Offset	1263 STD. .020 .030 .040 .060	2-5/64 1-3/16	2585585 3004535 3420214 3549528 FM 350NP	
V8-440 7.2L 4.3200(IN) 109.7(MM) CHRYSLER ENGINE	1972-80 8.0		Flat head. COMP HT: 1.912 PIN DIA: 1.094 Offset	1276 STD. .020 .030 .040 .060	2-5/64 1-3/16	3579047 FM 424NP	

CHRYSLER

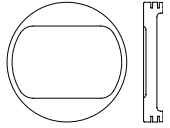
CYL BORE ENGINE	YEAR COMP. RATIO	VIN CODE	NOTES	PART NO. SIZE	RINGS	O.E. ASSY. NO. INTERCHANGE	HEAD SHAPE
V10-488 8.0L 4.0000(IN) 101.6(MM) CHRYSLER ENGINE	1994-01 8.6	W	Hypereutectic. Rectangular head recess .080" deep. "COATED SKIRTS". Not intended for Racing applications. COMP HT: 1.605 PIN DIA: .9842 Offset	3237HC STD. .020 .030 .040 .060	2-1.5mm 1-4.0mm	4741665 4778878 4778879 4856120 4856121 FM H689CP	

CONTINENTAL

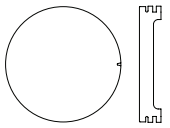
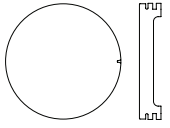
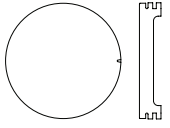
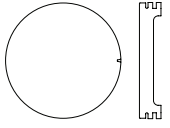

L4-163 2.6L 3.4375(IN) 87.3(MM) CONTINENTAL ENGINE			Flat head. F163 engine. COMP HT: 1.998 PIN DIA: .8593 Center	4501 STD. .020 .030 .040 .060	1-5/64 2-3/32 1-1/4	F163A04081E FM 1080P	
L6-226 3.7L 3.3130(IN) 84.1(MM) CONTINENTAL ENGINE	1946-65 7.3		Flat head. COMP HT: 1.980 PIN DIA: .8593 Center	2103 STD. .020 .030 .040 .060	2-3/32 2-5/32	207247 200108 FM 200NP	
L6-226 3.7L 3.3130(IN) 84.1(MM) CONTINENTAL ENGINE	1954-65 7.1		F226 & F227 flat head. COMP HT: 2.000 PIN DIA: .8593 Center	4537 STD. .020 .030 .040 .060	1-5/64 2-3/32 1-1/4	F227A4061E FM 704P	
L6-245 4.0L 3.4375(IN) 87.3(MM) CONTINENTAL ENGINE			Flat head. F245 engine. COMP HT: 1.998 PIN DIA: .8593 Center	4538 STD. .020 .030 .040 .060	1-5/64 2-3/32 1-1/4	F163A04081E FM 1080P	

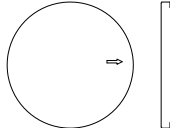
FORD INDUSTRIAL

L4-79 1.3L 2.9124(IN) 3.975(MM) FORD INDUSTRIAL	1998-01		Flat Top with no valve reliefs Press pin INDUSTRIAL COMP HT: 1.157 PIN DIA: .710 Offset	3322 STD. .5mm .75mm 1.0mm	1.5mm 1.75mm 3.0mm		
--	---------	--	--	---	--------------------------	--	---

FORD

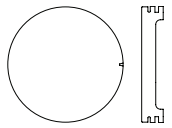
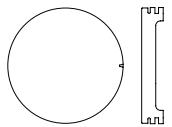
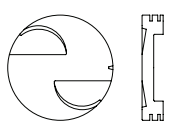
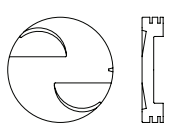
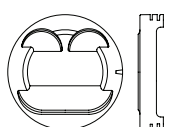

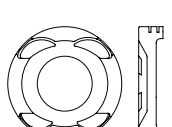
CYL BORE ENGINE	YEAR COMP. RATIO	VIN CODE	NOTES	PART NO. SIZE	RINGS	O.E. ASSY. NO. INTERCHANGE	HEAD SHAPE
L4-79 1.3L 2.7953(IN) 71.0(MM) MAZDA ENGINE	1988-95 9.0	H	2.400" dia. head recess .040" deep w/3 valve reliefs. COMP HT: 1.120 PIN DIA: .7870 Offset	3126 STD. .25mm .5mm .75mm 1.0mm	1-1.2mm 1-1.5mm 1-3.0mm	E8BZ6108A F4BZ6108A FM 546P	
L4-97.6 1.6L 3.1496(IN) 80.0(MM) FORD ENGINE	1981-85 8.8		Contoured head w/2 deep valve reliefs. Non-turbo. COMP HT: 1.560 PIN DIA: .8120 Offset	1181 STD. .5mm .75mm 1.0mm 1.5mm	1-1.6mm 1-2.0mm 1-4.0mm	E1FZ6108G E3FZ6108A FM 488P	
L4-109.6 1.8L 3.0709(IN) 78.0(MM) MAZDA ENGINE	1972-80 8.3		Dome head .310" high. Courier. Piston may be used to replace piston with dished head. COMP HT: 1.455 PIN DIA: .8665 Offset	1168 STD. .5mm .75mm 1.0mm 1.5mm	2-1.5mm 1-4.0mm	D27Z6108B D27Z6108A D77Z6108A FM 485P	
L4-116 1.9L 3.2260(IN) 81.94(MM) FORD ENGINE	1985-86 9.0		Flat head w/2 valve reliefs. COMP HT: 1.470 PIN DIA: .8121 Offset	1190 STD. .5mm .75mm 1.0mm	2-1.5mm 1-4.0mm Shallow Groove	E5FZ6108A E6FZ6108G FM 494P	
L4-116 1.9L 3.2260(IN) 81.94(MM) FORD ENGINE	1985-86 9.0		Contoured head w/2 deep valve reliefs. EFI. COMP HT: 1.540 PIN DIA: .8121 Offset	1191 STD. .5mm .75mm 1.0mm	2-1.5mm 1-4.0mm Shallow Groove	E6FZ6108A FM 610P	
L4-116 1.9L 3.2260(IN) 81.94(MM) FORD ENGINE	1987-90 9.0		Hypereutectic. Contoured head w/2 deep valve reliefs. EFI. Not intended for Racing applications. COMP HT: 1.367 PIN DIA: .8121 Offset	1194H STD. .5mm .75mm 1.0mm	2-1.5mm 1-3.0mm Shallow Groove	E7FZ6108D-E FM H542P	
L4-116 1.9L 3.2260(IN) 81.94(MM) FORD ENGINE	1987-96 9.0	J	Wedge type head recess .250" deep w/2 valve reliefs. CFI. COMP HT: 1.286 PIN DIA: .8121 Offset	3119 STD. .5mm .75mm 1.0mm	2-1.5mm 1-3.0mm Shallow Groove	E7FZ6108G-H-J F1CZ6108A-B-C FM H529P	
L4-116 1.9L 3.2260(IN) 81.94(MM) FORD ENGINE	1987-96 9.0	J	Hypereutectic. Wedge type head recess .250" deep w/2 valve reliefs. CFI. Not intended for Racing applications. COMP HT: 1.286 PIN DIA: .8121 Offset	3119H STD. .5mm .75mm 1.0mm	2-1.5mm 1-3.0mm Shallow Groove	E7FZ6108G-H-J F1CZ6108A-B-C FM H529P	

CYL BORE ENGINE	YEAR COMP. RATIO	VIN CODE	NOTES	PART NO. SIZE	RINGS	O.E. ASSY. NO. INTERCHANGE	HEAD SHAPE
L4-122 2.0L 3.5750(IN) 90.81(MM) FORD ENGINE	1971-74 8.0		Flat head. COMP HT: 1.588 PIN DIA: .9450 Offset	1156 STD. .020 .030 .040 .060	1-2.0mm 1-2.5mm 1-4.0mm	D1FZ6108E FM 397P	
L4-122 2.0L 3.1496(IN) 80.0(MM) FORD ENGINE	1979-82 8.0		Flat head. Use early design ring pack. COMP HT: 1.406 PIN DIA: .7868 Offset	1182 STD. .5mm .75mm 1.0mm 1.5mm	1-1.2mm 1-1.5mm 1-4.0mm	D97Z6108A FM 12215P	
L4-122 2.0L 3.5180(IN) 89.4(MM) FORD ENGINE	1982-88 8.0		Flat head w/2 valve reliefs. COMP HT: 1.578 PIN DIA: .9122 Offset	1184 STD. .020 .030 .040 .060	2-2.0mm 1-4.75mm	E37Z6108A E3TZ6108MB	
L4-122 2.0L 3.5180(IN) 89.4(MM) FORD ENGINE	1982-88 8.0		Hypereutectic. Flat head w/2 valve reliefs. Not intended for Racing applications. COMP HT: 1.578 PIN DIA: .9122 Offset	1184H STD. .020 .030 .040 .060	2-2.0mm 1-4.75mm	E37Z6108A E3TZ6108MB FM H491P	
L4-122 2.0L 3.3409(IN) 84.86(MM) FORD ENGINE	1995-97 9.6	3	Hypereutectic. Dome head .050" high w/3 valve reliefs. Zetec engine. Not intended for Racing applications. COMP HT: 1.285 PIN DIA: .8120 Offset	3162H STD. .5mm .75mm 1.0mm	1-1.5mm 1-1.75mm 1-3.0mm	F5RZ6108A FM H672P	
L4-122 2.0L 3.3409(IN) 84.86(MM) FORD ENGINE	1997-02 9.2	P	Hypereutectic. Dome head .190" high w/2 valve reliefs. Not intended for Racing applications. COMP HT: 1.460 PIN DIA: .8120 Offset	3167H STD. .5mm .75mm 1.0mm	2-1.5mm 1-3.0mm Shallow Groove	1S4Z6100AA	
L4-122 2.0L 3.3409(IN) 84.86(MM) FORD ENGINE	1997-02 9.2	P	Hypereutectic. Dome head .190" high w/2 valve reliefs. *Same as 3167H with "COATED SKIRTS". Not intended for Racing applications. COMP HT: 1.460 PIN DIA: .8120 Offset	3167HC STD. .5mm .75mm 1.0mm	2-1.5mm 1-3.0mm Shallow Groove	1S4Z6100AA FM H848CP	
L4-134 2.2L 3.3858(IN) 86.0(MM) MAZDA ENGINE	1988-92 8.6	C L	2.610" dia. head recess .247" deep w/4 valve reliefs. Non-turbo. COMP HT: 1.420 PIN DIA: .8657 Offset	3100 STD. .5mm .75mm 1.0mm	2-1.5mm 1-4.0mm	E92Z6108A FM 548P	

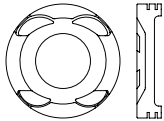
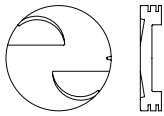
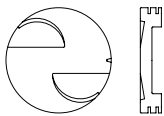
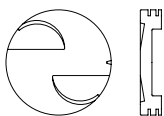
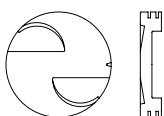
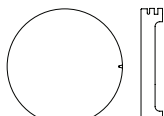
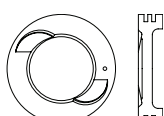
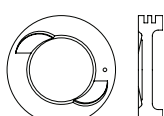
FORD

CYL BORE ENGINE	YEAR COMP. RATIO	VIN CODE	NOTES	PART NO. SIZE	RINGS	O.E. ASSY. NO. INTERCHANGE	HEAD SHAPE
L4-134 2.2L 3.3858(IN) 86.0(MM) MAZDA ENGINE	1988-92 7.8	C L	Hypereutectic. 2.570" dia. head recess .355" deep w/4 valve reliefs. Turbo. Not intended for Racing applications. COMP HT: 1.420 PIN DIA: .8657 Offset	3121H STD. .5mm .75mm 1.0mm	2-1.5mm 1-4.0mm	E92Z6108D FM H549P	
L4-140 2.3L 3.7795(IN) 96.0(MM) FORD ENGINE	1974-89 8.7		Flat head with two valve reliefs. Non-turbo. Courier, Mustang II and Pinto. COMP HT: 1.578 PIN DIA: .9122 Offset	1163 STD. .5mm .75mm 1.0mm 1.5mm	2-5/64 1-3/16	D4FZ6108A-B E35Z6108T E5ZZ6108A	
L4-140 2.3L 3.7795(IN) 96.0(MM) FORD ENGINE	1979-82 1989-95 9.5	A M S X	Hypereutectic. Flat head w/2 valve reliefs. Not intended for Racing applications. COMP HT: 1.578 PIN DIA: .9122 Offset	3124H STD. .5mm .75mm 1.0mm 1.5mm	2-1.5mm 1-4.0mm 79-82 Use Late Rings	E9TZ6108A F3ZZ6108A F1ZZ6108A D9ZZ6108A FM H537P	
L4-140 2.3L 3.7795(IN) 96.0(MM) FORD ENGINE	1984-92 8.7		Flat head w/2 valve reliefs. Similar to 1163 except ring pack. COMP HT: 1.578 PIN DIA: .9122 Offset	1197 STD. .5mm .75mm 1.0mm 1.5mm	2-1.5mm 1-4.0mm Shallow Groove	E5ZZ6108A FM 495P	
L4-140 2.3L 3.7795(IN) 96.0(MM) FORD ENGINE	1995-97 9.5	A	Hypereutectic. Flat head w/2 valve reliefs. Truck. COMP HT: 1.335 PIN DIA: .9122 Offset	3185H STD. .5mm .75mm 1.0mm	2-1.5mm 1-3.0mm Shallow Groove	F57Z6108AA FM H676P	
L4-141 2.3L 3.6800(IN) 93.5(MM) FORD ENGINE	1983-94 9.0	M S X	Flat head. High swirl combustion (HSC) engine. COMP HT: 1.500 PIN DIA: .9122 Offset	1185 STD. .020 .030 .040 .060	2-5/64 1-3/16	E43Z6108A-B F23Z6108A-B FM 489P	
L4-152 2.5L 3.7795(IN) 96.0(MM) FORD ENGINE	1998-01 9.4	C	2.375" dia. head recess .087" deep w/2 valve reliefs. COMP HT: 1.190 PIN DIA: .9122 Offset	3168 STD. .5mm .75mm 1.0mm	2-1.5mm 1-3.0mm Shallow Groove	F87Z-6108-JA	
L4-152 2.5L 3.7795(IN) 96.0(MM) FORD ENGINE	1998-01 9.4	C	Hypereutectic. 2.375" dia. head recess .087" deep w/2 valve reliefs. COMP HT: 1.190 PIN DIA: .9122 Offset	3168H STD. .5mm .75mm 1.0mm	2-1.5mm 1-3.0mm Shallow Groove	F87Z-6108-JA	

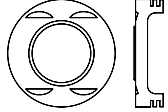
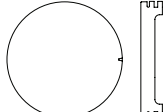
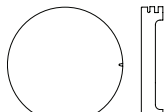
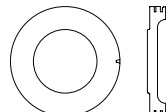
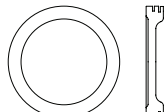
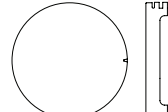
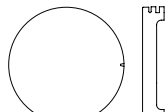
CYL BORE ENGINE	YEAR COMP. RATIO	VIN CODE	NOTES	PART NO. SIZE	RINGS	O.E. ASSY. NO. INTERCHANGE	HEAD SHAPE
L4-152 2.5L 3.7795(IN) 96.0(MM) FORD ENGINE	1998-01 9.4	C	Hypereutectic. 2.375" dia. head recess .087" deep w/2 valve reliefs. "COATED SKIRTS". COMP HT: 1.190 PIN DIA: .9122 Offset	3168HC STD. .5mm .75mm 1.0mm	2-1.5mm 1-3.0mm Shallow Groove	F87Z-6108-JA FM H865CP	
L4-153 2.5L 3.6811(IN) 93.5(MM) FORD ENGINE	1986-91 9.7		Flat head. High swirl combustion (HSC) engine with central fuel injection (CFI). COMP HT: 1.556 PIN DIA: .9122 Offset	1192 STD. .020 .030 .040 .060	2-5/64 1-3/16	E7DZ6108G FM 507P	
V6-155 2.5L 3.2400(IN) 82.3(MM) FORD ENGINE	1995-99	L	Hypereutectic. .057" High dome. "COATED SKIRTS". Not intended for Racing applications. Floating Pin. COMP HT: 1.171 PIN DIA: .8273 Offset	3184HC STD. .5mm .75mm 1.0mm	1-1.2mm 1-1.5mm 1-3.0mm Shallow Groove	F5RZ-6100-BA FM H663CP	
V6-155 2.5L 3.2400(IN) 82.3(MM) FORD ENGINE	1998-00		Hypereutectic. .096" High dome. "COATED SKIRTS". Not intended for Racing applications. Floating Pin. COMP HT: 1.171 PIN DIA: .8273 Offset	3183HC STD. .5mm .75mm 1.0mm	1-1.2mm 1-1.5mm 1-3.0mm Shallow Groove	1U2Z-6100-AA FM H849CP	
L6-170 2.8L 3.5000(IN) 88.9(MM) FORD ENGINE	1961-72 8.4		Flat head. COMP HT: 1.580 PIN DIA: .9122 Offset	1119 STD. .020 .030 .040 .060	2-5/64 1-3/16	C1DZ6108A-B C1GY6108A C1GY6108C C1DZ6108A C20Z6108F C5DZ6108A C5GY6108D FM 302NP	
V6-171 2.8L 3.6614(IN) 93.0(MM) GERMAN FORD ENGINE	1974-75 8.0		Flat head. Capri and Mustang II. COMP HT: 1.511 PIN DIA: .9450 Offset	1164 STD. .5mm .75mm 1.0mm 1.5mm	1-2.0mm 1-2.5mm 1-4.0mm	D4ZZ6100A FM 433NP	
V6-171 2.8L 3.6614(IN) 93.0(MM) GERMAN FORD ENGINE	1976-79 1983-85 8.0 8.5		Flat head. Ranger, Capri and Mustang II. COMP HT: 1.535 PIN DIA: .9450 Offset	1174 STD. .5mm .75mm 1.0mm 1.5mm	1-2.0mm 1-2.5mm 1-4.0mm	D6ZZ6100A FM 433 NP	
V6-177 2.9L 3.6614(IN) 93.0(MM) GERMAN FORD ENGINE	1986-92 1988-89 9.0	T V	2.420" dia. head recess .300" deep. COMP HT: 1.527 PIN DIA: .9450 Offset	1199 STD. .5mm .75mm 1.0mm 1.5mm	1-1.6mm 1-1.75mm 1-3.5mm Shallow Groove	E7RY-6102A E6TZ6100A FOTZ6100E FM 520P	

CYL BORE ENGINE	YEAR COMP. RATIO	VIN CODE	NOTES	PART NO. SIZE	RINGS	O.E. ASSY. NO. INTERCHANGE	HEAD SHAPE
V6-181 3.0L 3.5039(IN) 89.0(MM) MAZDA FORD ENGINE	1996-06 10.0	S	Hypereutectic. Duratec Engine .028" High dome w/4 valve reliefs. "COATED SKIRTS". Not intended for Racing applications. Floating Pin. COMP HT: 1.171 PIN DIA: .8272 Offset	3182HC STD. .25mm .5mm .75mm 1.0mm	1-1.2mm 1-1.5mm 1-3.0mm Shallow Groove	XW4Z-6100-CA FM H881CP	
V6-182 3.0L 3.5039(IN) 89.0(MM) FORD ENGINE	1986-00 9.3	T U V	Hypereutectic. Flat head. Not intended for Racing applications. COMP HT: 1.535 PIN DIA: .9122 Offset	1193H STD. .5mm .75mm 1.0mm	2-1.5mm 1-4.0mm Shallow Groove	E6DZ6108A-B E7DZ6108A-B F47Z6108A FM H497P	
V6-182 3.0L 3.5039(IN) 89.0(MM) FORD ENGINE	1986-00 9.3	T U V	Hypereutectic. Flat head. Not intended for Racing applications. "COATED SKIRTS". COMP HT: 1.535 PIN DIA: .9122 Offset	1193HC STD. .5mm .75mm 1.0mm	2-1.5mm 1-4.0mm Shallow Groove	E6DZ6108A-B E7DZ6108A-B F47Z6108A FM H497CP	
V6-183 3.0L 3.5039(IN) 89.0(MM) FORD ENGINE	1999-07 9.5	V U	Hypereutectic. 1.750" dia. .068" Dome Flex Fuel "COATED SKIRTS". COMP HT: 1.520 PIN DIA: .9121	3197HC STD. .5mm .75mm 1.0mm	2-1.5mm 1-3.0mm Shallow Groove	FM H875CP	
L-6 200 3.3L 3.6807(IN) 93.49(MM) AUSTRALIAN FORD ENGINE			Hypereutectic, Dish 2.967" Diameter, .071" Deep .060" Offset Pin Not Intended for Racing Applications COMP. HT: 1.530 PIN DIA: .912	3328H STD. .020 .030 .040 .060	2-1.5mm 1-4.0mm	RA9411	
L-6 200 3.3L 3.6807(IN) 93.49(MM) AUSTRALIAN FORD ENGINE			Hypereutectic, Flat Top .060" Offset Pin Not Intended for Racing Applications COMP. HT: 1.530 PIN DIA: .912	3327H STD. .020 .030 .040 .060	2-1.5mm 1-4.0mm	RA9410	
L4-200 3.3L 3.8750(IN) 98.4(MM) FORD ENGINE	1928-32 4.2		Model A. Flat head. COMP HT: 1.906 PIN DIA: .9997 Center	1000 STD. .020 .030 .040 .060 .080 .090 .100 .110 .125	2-1/8 1-5/32	FM 145P	
L6-200 3.3L 3.6800(IN) 93.5(MM) FORD ENGINE	1963-83 9.0		2.220" dia. head recess .085" deep. COMP HT: 1.500 PIN DIA: .9122 Offset	1120 STD. .020 .030 .040 .060	2-5/64 1-3/16	C30Z6108F C3YY6108A C5DZ6108F C5DZ6108N C5GY6108B C9DZ6108A FM 275NP	

CYL BORE ENGINE	YEAR COMP. RATIO	VIN CODE	NOTES	PART NO. SIZE	RINGS	O.E. ASSY. NO. INTERCHANGE	HEAD SHAPE
V6-214 3.5L 3.6417(IN) 92.5(MM) FORD ENGINE	2007-10 10.3:1	C W T	Hypereutectic, Dome 2.676" dia. .040" tall Four valve relief Floating Pin "COATED SKIRTS" Edge COMP HT: 1.243 PIN DIA: .905 Offset	3336HC STD. .5mm .75mm 1.0mm	1.2mm 1.5mm 2.5mm	9T4Z-6108-B KS1295	
NEW V6-214 3.5L 3.6417(IN) 92.5(MM) FORD DURATEC ENGINE	2007-10 10.3	C, W, T	Hypereutectic Dome. 2.704" dia. .044" tall. Four valve reliefs. Floating pin. COATED SKIRTS WITH ANODIZED TOP RING GROOVE AND CROWN. COMP HT: 1.230 PIN DIA: .905 Offset	3339HCA STD. .10mm .25mm .50mm .75mm 1.0mm	1-1.2mm 1-1.5mm 1-2.5mm	9T4Z-6108-B KS1295	
NEW V6-214 3.5L 3.6417(IN) 92.5(MM) FORD DURATEC ENGINE	2010-15 10.8	C, W, T	Hypereutectic Dome. 3.298" dia. .086" tall. Four valve reliefs. Floating pin. COATED SKIRTS WITH ANODIZED TOP RING GROOVE AND CROWN. COMP HT: 1.230 PIN DIA: .905 Offset	3340HCA STD. .10mm .25mm .50mm .75mm 1.0mm	1-1.2mm 1-1.5mm 1-2.5mm	AT4Z-6108-C KS1295-0922	
V8-221 3.6L 3.5000(IN) 88.9(MM) FORD ENGINE	1962-63 8.5		Flat head. COMP HT: 1.580 PIN DIA: .9122 Offset	3187 STD. .020 .030 .040 .060	2-5/64 1-3/16	C1DZ6108A C1GY6108A C20Z6108F FM 302NP	
I6-223 3.7L 3.6250(IN) 92.0(MM) FORD ENGINE	1954-64 8.3		Flat head. COMP HT: 1.857 PIN DIA: .9122 Offset	1079 STD. .020 .030 .040 .060 .080	2-3/32 1-3/16	EBP6108A B8A6108AA COAE6108AB COAE6108AC FM 1011P	
V6-232 3.8L 3.8110(IN) 96.8(MM) FORD ENGINE	1982-87 8.65		2.170" dia. head recess .071" deep w/2 valve reliefs. COMP HT: 1.584 PIN DIA: .9122 Offset	1183 STD. .5mm .75mm 1.0mm 1.5mm	2-2.0mm 1-4.0mm	E2DZ6108A E4DZ6108A FM 481P	
V6-232 3.8L 3.8110(IN) 96.8(MM) FORD ENGINE	1988-95 9.0	4	Hypereutectic. 2.170" dia. head recess .145" deep w/2 valve reliefs. Non-supercharged. Not intended for Racing applications. COMP HT: 1.614 PIN DIA: .9122 Offset	3128H STD. .5mm .75mm 1.0mm 1.5mm	2-1.5mm 1-4.0mm Shallow Groove	E8DZ6108A-B E9DZ6108G-H F1DZ6108A-B F2SZ6108A-B E9SZ6108A F4DZ6108A-B FM H523P	
V6-232 3.8L 3.8110(IN) 96.8(MM) FORD ENGINE	1988-95 9.0	4	Hypereutectic. 2.170" dia. head recess .145" deep w/2 valve reliefs. Non-supercharged. Coated skirts. COMP HT: 1.614 PIN DIA: .9122 Offset	3128HC STD. .5mm .75mm 1.0mm 1.5mm	2-1.5mm 1-4.0mm Shallow Groove	FM H523CP	

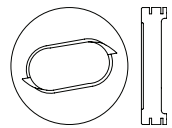
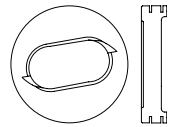
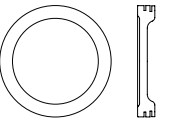
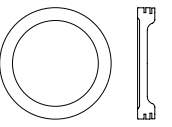
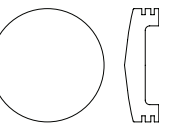
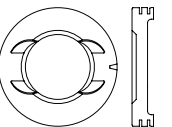
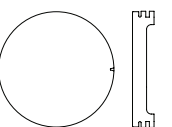
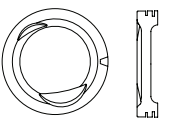

FORD

CYL BORE ENGINE	YEAR COMP. RATIO	VIN CODE	NOTES	PART NO. SIZE	RINGS	O.E. ASSY. NO. INTERCHANGE	HEAD SHAPE
V6-232 3.8L 3.8110(IN) 96.8(MM) FORD ENGINE	1989-95 8.2	R	Hypereutectic. Supercharged. Oblong head recess .170" deep. Not intended for Racing applications. Floating pin. COMP HT: 1.607 PIN DIA: .9122 Offset	3181H STD. .5mm .75mm 1.0mm	2-1.5mm 1-4.0mm Shallow Groove	F4SZ-6108-A FM H675P	
V6-232 3.8L 3.8110(IN) 96.8(MM) FORD ENGINE	1989-95 8.2	R	Hypereutectic. Supercharged. Oblong head recess .170" deep. Not intended for Racing applications. Same as 3181H with "COATED SKIRTS". Floating pin. COMP HT: 1.607 PIN DIA: .9122 Offset	3181HC STD. .5mm .75mm 1.0mm	2-1.5mm 1-4.0mm Shallow Groove	F4SZ-6108-A FM H675CP	
V6-232 3.8L 3.8110(IN) 96.80(MM) FORD ENGINE	1996-04 9.0	4	Hypereutectic. 2.150" dia. head recess .100" deep. Non-Supercharged. Not intended for Racing applications. Floating Pin. COMP HT: 1.430 PIN DIA: .9054 Offset	3159H STD. .5mm .75mm 1.0mm 1.5mm	2-1.5mm 1-3.0mm	F6ZZ6108A	
V6-232 3.8L 3.8110(IN) 96.80(MM) FORD ENGINE	1996-04 9.0	4	Hypereutectic. 2.150" dia. head recess .100" deep. Non-Supercharged. *Same as 3159H with "COATED SKIRTS". Not intended for Racing applications. Floating Pin. COMP HT: 1.430 PIN DIA: .9054 Offset	3159HC STD. .5mm .75mm 1.0mm 1.5mm	2-1.5mm 1-3.0mm	F6ZZ6108A FM H820CP	
V8-239 3.9L 3.1875(IN) 81.0(MM) FORD ENGINE	1939-53 7.0		Dome head. Flat head engine. Comp. ht. is to top of dome.	1058 STD. .020 .030 .040 .060 .080 .100	2-3/32 2-3/16	8BA6108A FM 1003P	
L6-240 3.9L 4.0000(IN) 101.6(MM) FORD ENGINE	1966-68 8.4		2.450" dia. head recess .140" deep w/4 valve reliefs. COMP HT: 1.585 PIN DIA: .9122 Offset	3188 STD. .020 .030 .040 .060 .080	2-5/64 1-3/16	C3AZ6108AF C80Z6108A C4AZ-B FM 272AP	
L6-240 3.9L 4.0000(IN) 101.6(MM) FORD ENGINE	1969-74 8.7		Flat head. COMP HT: 1.576 PIN DIA: .9752 Offset	1147 STD. .020 .030 .040 .060	2-5/64 1-3/16	C8AZ6108C-D FM 352AP	
L6-238 3.9L 3.6176(IN) 91.888(MM) AUSTRALIAN FORD ENGINE L-6 244	1987 8.3		Hypereutectic, Dish 2.528 Dia. .192 Deep .060 Offset Pin COMP HT: 1.375 PIN DIA: .912	3331H STD. .5mm 1.0mm	2-1.5mm 1-4.0mm	PR 3901	

CYL BORE ENGINE	YEAR COMP. RATIO	VIN CODE	NOTES	PART NO. SIZE	RINGS	O.E. ASSY. NO. INTERCHANGE	HEAD SHAPE
V6-244 4.0L 3.9527(IN) 100.4(MM) FORD ENGINE	1990-94	X	Hypereutectic. 2.460" dia. head recess .305" deep. Truck COMP HT: 1.450 PIN DIA: .9450 Offset	3156H STD. .5mm .75mm 1.0mm	1-1.6mm 1-1.75mm 1-3.5mm	F0TZ6100A F2TZ-6108E ZZLO-11-100A FM H570P	
V6-244 4.0L 3.9527(IN) 100.4(MM) FORD ENGINE	1990-94	X	Hypereutectic. 2.460" dia. head recess .305" deep. Truck. *Same as 3156H with "COATED SKIRTS". COMP HT: 1.450 PIN DIA: .9450 Offset	3156HC STD. .5mm .75mm 1.0mm	1-1.6mm 1-1.75mm 1-3.5mm	F0TZ6100A F2TZ-6108E ZZLO-11-100A	
V6-244 4.0L 3.9527(IN) 100.4(MM) FORD ENGINE	1995-98 9.0	X W	Hypereutectic. 3.130" dia. head recess .330" deep. Truck. COMP HT: 1.450 PIN DIA: .9450 Offset	3151H STD. .5mm .75mm 1.0mm	1-1.6mm 1-1.75mm 1-3.5mm	F5TZ6100A F6TZ-6108NA ZZMB-23-200 FM H667P	
V6-244 4.0L 3.9527(IN) 100.4(MM) FORD ENGINE	1997-02 9.0	E K	Hypereutectic. Flat head. Truck. "COATED SKIRTS". COMP HT: 1.435 PIN DIA: .9450 Offset	3155HC STD. .5mm .75mm 1.0mm	1-1.6mm 1-1.75mm 1-3.5mm	F7TZ-6108-TA FM H843CP	
L6-241 4.0L 3.6323(IN) 92.26(MM) AUSTRALIAN FORD ENGINE			Hypereutectic, Dome .047" High 4 Valve Reliefs .060" Offset Pin Propane Application COMP HT: 1.215 PIN DIA: .912	3333H STD. .5mm 1.0mm	1-1.2mm 1-1.5mm 1-3mm	RA4011S	
L6-241 4.0L 3.6329(IN) 92.275(MM) AUSTRALIAN FORD ENGINE			Hypereutectic, Dish 2.508" dia. .063" deep .060" Offset Pin Single Valve Relief COMP HT: 1.394 PIN DIA: .912 Offset	3326H STD. .5mm 1.0mm 1.5mm	2-1.5mm 1-3.0mm	L-6 EF-EL ENGINE SOHC 2V RA9400	
L6-241 4.0L 3.6329(IN) 92.275(MM) AUSTRALIAN FORD ENGINE			Hypereutectic, Dish 2.491" dia. .112" deep .060" Offset Pin Single Valve Relief COMP HT: 1.375 PIN DIA: .912 Offset	3325H STD. .5mm 1.0mm	2-1.5mm 1-3.0mm	L-6 EF-EL ENGINE SOHC 2V RA4001	
L6-241 4.0L 3.6329(IN) 92.275(MM) AUSTRALIAN FORD ENGINE			Hypereutectic, Dish 2.700" dia. .155" deep .060" Offset Pin Single Valve Relief COMP HT: 1.375 PIN DIA: .912 Offset	3324H STD. .5mm 1.0mm	2-1.5mm 1-3.0mm	L-6 EB-ED ENGINE SOHC 2V RA2864	

FORD

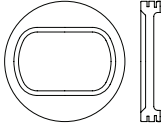
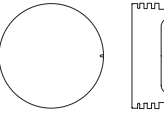
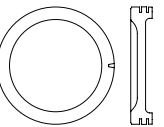
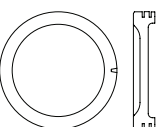
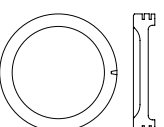
CYL BORE ENGINE	YEAR COMP. RATIO	VIN CODE	NOTES	PART NO. SIZE	RINGS	O.E. ASSY. NO. INTERCHANGE	HEAD SHAPE
L6-244 4.0L 3.6319(IN) 92.25(MM) AUSTRALIAN FORD ENGINE			Hypereutectic with dual circular dish outer dish .133" with inner dish at .038" Single valve relief Press Pin "COATED SKIRTS" COMP HT: 1.208 PIN DIA: .912 Offset	3334HC STD. .5mm 1.0mm	1.2mm 1.5mm 3.0mm	8901865 RA40025	
L6-250 4.1L 3.6807(IN) 93.49(MM) AUSTRALIAN FORD ENGINE			Hypereutectic, Dish 2.843" dia. .276" deep .060" Offset Pin Unleaded Fuel COMP HT: 1.530 PIN DIA: .912 Offset	3332H STD. .020 .030 .040 .060	2-5/64 1-3/16	RA4106	
L6-250 4.1L 3.6807(IN) 93.49(MM) AUSTRALIAN FORD ENGINE			Hypereutectic, Dish 2.967" dia. .071" deep .060" Offset Pin COMP HT: 1.530 PIN DIA: .912 Offset Not intended for racing applications	3328H STD. .020 .030 .040 .060	2-1.5mm 1-4.0mm	RA9411	
L6-250 4.1L 3.6807(IN) 93.49(MM) AUSTRALIAN FORD ENGINE			Hypereutectic, Flat Top .060" Offset Pin COMP HT: 1.530 PIN DIA: .912 Offset Not intended for racing applications	3327H STD. .020 .030 .040 .060	2-1.5mm 1-4.0mm	RA9410	
L6-250 4.1L 3.6800(IN) 93.5(MM) FORD ENGINE	1969-02 9.0		2.220" dia. head recess. .085" deep. COMP HT: 1.500 PIN DIA: .9122 Offset	1120 STD. .020 .030 .040 .060	2-5-64 1-3/16	C9DZ6108A-B FM 275P	
V8-255 4.2L 3.6800(IN) 93.5(MM) FORD ENGINE	1980-82 8.8		Flat head w/4 valve reliefs. COMP HT: 1.585 PIN DIA: .9122 Offset	1176 STD. .020 .030 .040 .060	2-5/64 1-3/16	EOSZ6108A FM 478P	
V8-256 4.2L 3.6250(IN) 92.0(MM) FORD ENGINE	1954-55 8.3		Flat head. COMP HT: 1.857 PIN DIA: .9122 Offset	3186 STD. .020 .030 .040 .060 .080	2-3/32 1-3/16	EBP6108A COAE6108AB FM 1011P	
V6-256 4.2L 3.8122(IN) 96.83(MM) FORD ENGINE	1996-02 9.3		Hypereutectic. Oblong head recess .150" deep. Truck. COMP HT: 1.255 PIN DIA: .9054 Offset	3152H STD. .25mm .5mm .75mm 1.0mm	2-1.5mm 1-3.0mm	F65Z6108AB	

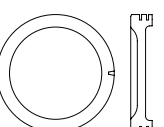
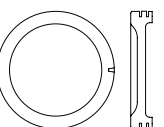
CYL BORE ENGINE	YEAR COMP. RATIO	VIN CODE	NOTES	PART NO. SIZE	RINGS	O.E. ASSY. NO. INTERCHANGE	HEAD SHAPE
V6-256 4.2L 3.8122(IN) 96.83(MM) FORD ENGINE	1996-02 9.3		Hypereutectic. Oblong head recess .150" deep. Truck. *Same as 3152H with "COATED SKIRTS". COMP HT: 1.255 PIN DIA: .9054 Offset	3152HC STD. .25mm .5mm .75mm 1.0mm	2-1.5mm 1-3.0mm	F65Z6108AB FM H850CP	
V8-260 4.3L 3.8000(IN) 96.5(MM) FORD ENGINE	1962-64 8.4		Flat head. 4 groove piston. Top groove is a carbon collector. COMP HT: 1.580 PIN DIA: .9122 Offset	1106 STD. .020 .030 .040 .060	1-5/64 1-3/32 1-3/16	C20Z6108A-L C2Y6108A	
V8-281 4.6L 3.5512(IN) 90.2(MM) FORD ENGINE	1990-97 SOHC 9.0 DOHC 9.8	W	Hypereutectic. 2.700" dia. head recess .157" deep. SOHC and DOHC. Not intended for Racing applications. COMP HT: 1.200 PIN DIA: .8665 Offset	3135H STD. .25mm .5mm .75mm 1.0mm	2-1.5mm 1-3.0mm Shallow Groove	F1AZ6108A F2AZ6108A F3AZ6108A F2AE6018AA F5AZ-6108A	
V8-281 4.6L 3.5512(IN) 90.2(MM) FORD ENGINE	1990-97 SOHC 9.0 DOHC 9.8	W	Hypereutectic. 2.700" dia. head recess .157" deep. SOHC and DOHC. *Same as 3135H with "COATED SKIRTS". Not intended for Racing applications. COMP HT: 1.200 PIN DIA: .8665 Offset	3135HC STD. .25mm .5mm .75mm 1.0mm	2-1.5mm 1-3.0mm Shallow Groove	F1AZ6108A F2AZ6108A F3AZ6108A F2AE6018AA F5AZ-6108A FM H591CP	
V8-281 4.6L 3.5512(IN) 90.2(MM) FORD ENGINE	1991-00		Hypereutectic. Triton Engine. 2.675" dia. head recess .170" deep. "COATED SKIRTS". Not intended for Racing applications. COMP HT: 1.215 PIN DIA: .8660 Offset	3174HC STD. .25mm .5mm .75mm 1.0mm	2-1.5mm 1-3.0mm Shallow Groove	 FM H858CP	
V8-281 4.6L 3.5512(IN) 90.2(MM) FORD ENGINE	1993-97 9.85 DOHC	V	Hypereutectic. 32-Valve Triton Engine. 2.700" dia. head recess .060" deep. "COATED SKIRTS". Not intended for Racing applications. Floating Pin. COMP HT: 1.215 PIN DIA: .8660 Offset	3179HC STD. .25mm .5mm .75mm 1.0mm	2-1.5mm 1-3.0mm Shallow Groove	F3LZ-6108-EA FM H614CP	
V8-281 4.6L 3.5512(IN) 90.2(MM) FORD ENGINE	1997-04 9.0 SOHC	6 X	Hypereutectic. Triton Engine. 2.650" dia. head recess .160" deep. "COATED SKIRTS". Not intended for Racing applications. Floating Pin. COMP HT: 1.210 PIN DIA: .8660 Offset	3180HC STD. .25mm .5mm .75mm 1.0mm	2-1.5mm 1-3.0mm Shallow Groove	XC2Z-6108-CA FM H831CP	
V8-281 4.6L 3.5512(IN) 90.2(MM) FORD ENGINE	2001-06 9.0	W	Hypereutectic. Triton Engine. 3.050" dia. head recess .150" deep. "COATED SKIRTS". Not intended for Racing applications. Press Pin. COMP HT: 1.215 PIN DIA: .8660 Offset	3175HC STD. .25mm .5mm .75mm 1.0mm	2-1.5mm 1-3.0mm Shallow Groove	1L2Z-6108-AA FM H864CP	

3338HC - 4.6L. Same as 3175HC but with floating pin.

FORD

CYL BORE ENGINE	YEAR COMP. RATIO	VIN CODE	NOTES	PART NO. SIZE	RINGS	O.E. ASSY. NO. INTERCHANGE	HEAD SHAPE
V8-281 4.6L 3.5512(IN) 90.2(MM) FORD ENGINE	2006-10 9.8:1	H	Hypereutectic, Dish 2.600" dia. .050" deep Two valve relief Floating Pin "COATED SKIRTS" Mustang GT COMP HT: 1.220 PIN DIA: .866 Offset	3335HC STD. .25mm .5mm .75mm 1.0mm	1.5mm 1.5mm 3.0mm	9T4Z-6108-B KS1295	
NEW V8-281 4.6L 3.5512 90.2(MM) FORD ENGINE	2014	W X	Hypereutectic. Same as 3175HC but with floating pin. 3.050" dia. head recess .150" deep. "COATED SKIRTS" Not intended for racing applications Floating Pin COMP HT: 1.215 PIN DIA: .866 Offset	3338HC STD. .25mm .50mm .75mm 1.0mm	1-1.5mm 1-1.5mm 1-3.0mm Shallow Oil Groove		
V8-289 4.7L 4.0000(IN) 101.6(MM) FORD ENGINE	1964-68 8.2		2.450" dia. head recess .140" deep w/4 valve reliefs. COMP HT: 1.585 PIN DIA: .9122 Offset	1157 STD. .020 .030 .040 .060 .080	2-5/64 1-3/16	C3AZ6108P C4AZ6108B C4GY6108D C3AZ6108AA-AF C50E6108AE-AF FM 272AP	
V8-289 4.7L 4.0000(IN) 101.6(MM) FORD ENGINE	1964-68 SEE NOTES		Flat head w/4 valve reliefs. Comp. Ratios with cyl. heads. 51cc=9.7; 54cc=9.3; 58cc=8.8; 64cc=8.3; 69cc=7.8. COMP HT: 1.585 PIN DIA: .9122 Offset	1177 STD. .020 .030 .040 .060	2-5/64 1-3/16	D9AZ6108A E6TZ6108A-B FM 273AP	
V8-289 4.7 4.0000(IN) 101.6(MM) FORD ENGINE	1964-68 SEE NOTES		Hypereutectic. Flat head w/4 valve reliefs. Comp. Ratios with cyl. Heads: 51cc=9.7; 54cc=9.3; 58cc=8.8; 64cc=8.3; 69cc=7.8. COMP HT: 1.585 PIN DIA: .9122 Offset	1177H STD. .020 .030 .040 .060	2-5/64 1-3/16		
V8-289 4.7 4.0000(IN) 101.6(MM) FORD ENGINE	1964-68 SEE NOTES		Hypereutectic. Flat head w/4 valve reliefs. Comp. Ratios with cyl. Heads: 51cc=9.7; 54cc=9.3; 58cc=8.8; 64cc=8.3; 69cc=7.8. COMP HT: 1.585 PIN DIA: .9122 Offset	1177HC STD. .020 .030 .040 .060	2-5/64 1-3/16	FM H273CP	
V8-289 4.7L 4.0000(IN) 101.6(MM) FORD ENGINE	1964-68 SEE NOTES		Hypereutectic. Flat top w/4 valve reliefs. Comp. Ratios with cyl. heads. 51cc=10.2; 54cc=9.7; 58cc=9.2; 64cc= 8.7; 69cc=8.2. Not De-stroked. *Same as 3101H with "COATED SKIRTS". Not intended for Racing applications. COMP HT: 1.605 PIN DIA: .9122 Offs	3101HC STD. .020 .030 .040 .060	2-5/64 1-3/16 Shallow Oil Groove 2M5615	D9AZ6108A E6TZ6108A-B FM H273CP	
V8-292 4.8L 3.7500(IN) 95.3(MM) FORD ENGINE	1955-62 8.6		Flat head. Floating Pin. COMP HT: 1.760 PIN DIA: .9122 Offset	1072 STD. .020 .030 .040 .060	2-5/64 1-3/16	B5A6108B EDB6108B-C FM 1022P	

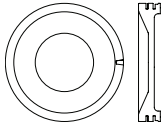
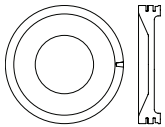
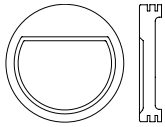
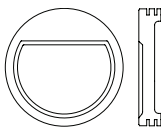
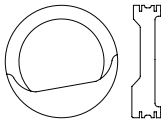
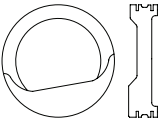
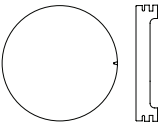
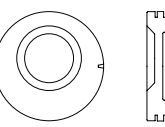
CYL BORE ENGINE	YEAR COMP. RATIO	VIN CODE	NOTES	PART NO. SIZE	RINGS	O.E. ASSY. NO. INTERCHANGE	HEAD SHAPE
L6-300 4.9L 4.0000(IN) 101.6(MM) FORD ENGINE	1969-79 7.8		Hypereutectic. 3.220" dia. head recess .300" deep. Truck. Not intended for Racing applications. COMP HT: 1.763 PIN DIA: .9752 Offset	3158H	2-5/64, 1-3/16	N/A FM H554P	
				STD. .020 .030 .040 .060			
L6-300 4.9L 4.0000(IN) 101.6(MM) FORD ENGINE	1969-79 7.8		Hypereutectic. 3.220" dia. head recess .300" deep. Truck. *Same as 3158H with "COATED SKIRTS". Not intended for Racing applications. COMP HT: 1.763 PIN DIA: .9752 Offset	3158HC	2-5/64, 1-3/16	N/A FM H554CP	
				STD. .020 .030 .040 .060			
L6-300 4.9L 4.0000(IN) 101.6(MM) FORD ENGINE	1969-87 8.0		"D" shaped head recess .260" deep. Truck engine after L16. COMP HT: 1.740 PIN DIA: .9752 Offset	3136	2-5/64 1-3/16	C9TZ6108A D1TZ6108G D3TZ6108A E4TZ6108P E45Z6108A E45Z6108L FM 1070P	
				STD. .020 .030 .040 .060			
L6-300 4.9L 4.0000(IN) 101.6(MM) FORD ENGINE	1969-87 8.0		"D" shaped head recess .260" deep. Truck engine after L16. COMP HT: 1.740 PIN DIA: .9752 Offset	3141D	2-5/64 1-3/16 Iron Top Groove	D1TZ6108A D3TZ6108G	
				STD. .020 .030 .040 .060			
L6-300 4.9L 4.0000(IN) 101.6(MM) FORD ENGINE	1969-92 8.3		Hypereutectic. 3.000" dia. head recess .240" deep w/.055 quench step for HD service. Comp. with 69cc cyl. head=8.3. Not intended for Racing applications. COMP HT: 1.778 PIN DIA: .9752 Offset	3117H	2-5/64 1-3/16	E4TZ6108N	
				STD. .020 .030 .040 .060			
L6-300 4.9L 4.0000(IN) 101.6(MM) FORD ENGINE	1969-92 8.3 8.7		Hypereutectic. 2.700" dia. head recess .215" deep w/.055 quench step for HD service. Comp. with 76cc cyl. head= 8.3; 69cc= 8.7. Not intended for Racing applications. COMP HT: 1.778 PIN DIA: .9752 Offset	3118H	2-5/64 1-3/16	E4TZ6108N	
				STD. .020 .030 .040 .060			
L6-300 4.9L 4.0000(IN) 101.6(MM) FORD ENGINE	1975-76 7.9		Flat head. Truck engine E-100 or F-100, LC. COMP HT: 1.576 PIN DIA: .9752 Offset	1147	2-5/64 1-3/16	C8AZ6108C-D FM 352AP	
				STD. .020 .030 .040 .060			
L6-300 4.9L 4.0000(IN) 101.6(MM) FORD ENGINE	1977-86 8.7		2.340" dia. Off center head recess .280" deep. Truck engine. COMP HT: 1.763 PIN DIA: .9752 Offset	1170	2-5/64 1-3/16	D7TZ6108A E1TZ6108A E3TZ6108F	
				STD. .020 .030 .040 .060			





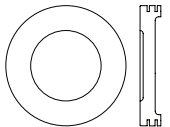
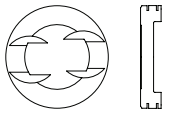
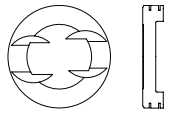
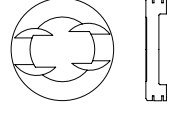
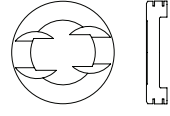
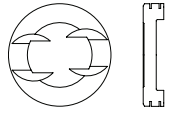
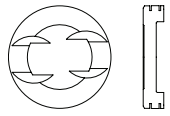
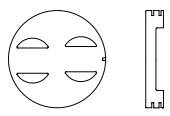

FORD

CYL BORE ENGINE	YEAR COMP. RATIO	VIN CODE	NOTES	PART NO. SIZE	RINGS	O.E. ASSY. NO. INTERCHANGE	HEAD SHAPE
L6-300 4.9L 4.0000(IN) 101.6(MM) FORD ENGINE	1987-96	Y	"D" shaped head recess .310" deep. Truck engine. EFI.	1186	2-5/64 1-3/16	E7TZ6108A-B E4TZ6108A-B E45Z6108L-M E3TZ6108F-G	
	8.7		COMP HT: 1.776 PIN DIA: .9752 Offset	STD. .020 .030 .040 .060			
L6-300 4.9L 4.0000(IN) 101.6(MM) FORD ENGINE	1987-96	Y	Hypereutectic. "D" shaped head recess .310" deep. Truck engine. EFI. Not intended for Racing applications.	1186H	2-5/64 1-3/16	E7TZ6108A-B E4TZ6108A-B E45Z6108L-M E3TZ6108F-G FM H519P	
	8.7		COMP HT: 1.776 PIN DIA: .9752 Offset	STD. .020 .030 .040 .060			
L6-300 4.9L 4.0000(IN) 101.6(MM) FORD ENGINE	1996-97		Hypereutectic. "D" shaped head recess .290" deep. Truck engine. EFI. Not intended for Racing applications.	3171H	2-2.0mm 1-4.0mm Shallow Groove	N/A FM H674P	
	N/A		COMP HT: 1.767 PIN DIA: .9752 Offset	STD. .020 .030 .040 .060			
V8-302 5.0L 4.0000(IN) 101.6(MM) FORD ENGINE	1968-76		2.450" dia. head recess .140" deep w/4 valve reliefs.	1157	2-5/64 1-3/16	C80Z6108A-B C90Z6108N-R D30Z6108A FM 272AP	
	8.2		COMP HT: 1.585 PIN DIA: .9122 Offset	STD. .020 .030 .040 .060 .080			
V8-302 5.0L 4.0000(IN) 101.6(MM) FORD ENGINE	1968-92		Hypereutectic. Flat top w/4 valve reliefs. Comp. Ratios with cyl. heads. 51cc=10.2; 54cc=9.7; 58cc=9.2; 64cc= 8.7; 69cc=8.2. Not De-stroked. Not intended for Racing applications.	3101HC	2-5/64 1-3/16 Shallow Oil Groove 2M5615	D9AZ6108A E6TZ6108A-B FM H273CP	
	SEE NOTES		COMP HT: 1.605 PIN DIA: .9122 Offs	STD. .020 .030 .040 .060			
V8-302 5.0L 4.0000(IN) 101.6(MM) FORD ENGINE	1977-86		Flat head w/4 valve reliefs. Comp. Ratios with cyl. heads: 51cc=9.7; 54cc=9.3; 58cc=8.8; 64cc=8.3; 69cc=7.8.	1177	2-5/64 1-3/16	D9AZ6108A E6TZ6108A-B FM 273AP	
	SEE NOTES		COMP HT: 1.585 PIN DIA: .9122 Offset	STD. .020 .030 .040 .060			
V8-302 5.0 4.0000(IN) 101.6(MM) FORD ENGINE	1977-86		Hypereutectic. Flat head w/4 valve reliefs. Comp. Ratios with cyl. Heads: 51cc=9.7; 54cc=9.3; 58cc=8.8; 64cc=8.3; 69cc=7.8.	1177H	2-5/64 1-3/16		
	SEE NOTES		COMP HT: 1.585 PIN DIA: .9122 Offset	STD. .020 .030 .040 .060 .080			
V8-302 5.0 4.0000(IN) 101.6(MM) FORD ENGINE	1977-86		Hypereutectic. Flat head w/4 valve reliefs. Comp. Ratios with cyl. Heads: 51cc=9.7; 54cc=9.3; 58cc=8.8; 64cc=8.3; 69cc=7.8.	1177HC	2-5/64 1-3/16	FM H273CP	
	SEE NOTES		COMP HT: 1.585 PIN DIA: .9122 Offset	STD. .020 .030 .040 .060			

CYL BORE ENGINE	YEAR COMP. RATIO	VIN CODE	NOTES	PART NO. SIZE	RINGS	O.E. ASSY. NO. INTERCHANGE	HEAD SHAPE
V8-302 5.0L 4.0000(IN) 101.6(MM) FORD ENGINE	1986-91 8.9		2.500" dia. head recess .050" deep. COMP HT: 1.600 PIN DIA: .9122 Offset	3169 STD. .020 .030 .040 .060	2-1.5mm 1-4.0mm Shallow Groove	E6AZ-6108-A FM 506P	
V8-302 5.0L 4.0000(IN) 101.6(MM) FORD ENGINE	1986-94 8.2		2.500" dia. head recess.030" deep w/4 valve reliefs. COMP HT: 1.608 PIN DIA: .9122 Offset	1195 STD. .020 .030 .040 .060	2-1.5mm 1-4.0mm Shallow Groove	E6AZ6108A E7TZ6108G-H FM 517P	
V8-302 5.0L 4.0000(IN) 101.6(MM) FORD ENGINE	1986-94 8.2		2.500" dia. head recess .030" deep w/4 valve reliefs. Coated skirts. COMP HT: 1.608 PIN DIA: .9122 Offset	1195C STD. .020 .030 .040 .060	2-1.5mm 1-4.0mm Shallow Groove	FM 517CP	
V8-302 5.0L 4.0000(IN) 101.6(MM) FORD ENGINE	1987-95 9.1	D E N T	Hypereutectic. 2.450" dia. head recess .029" deep w/4 valve reliefs. High Output. Not intended for Racing applications. STD based on 4.004 bore. COMP HT: 1.600 PIN DIA: .9122 Offset	3133H STD. .020 .030 .040 .060	2-1.5mm 1-4.0mm Shallow Groove	E7ZZ-6108A-B F3ZZ6108D-E E6ZZ6108A-B F2ZZ6108A-B FM H606P	
V8-302 5.0L 4.0000(IN) 101.6(MM) FORD ENGINE	1987-95 9.1	D E N T	Hypereutectic. 2.450" dia. head recess .029" deep w/4 valve reliefs. High Output. Not intended for Racing applications. *Same as 3133H with "COATED SKIRTS". STD based on 4.004 bore. COMP HT: 1.600 PIN DIA: .9122 Offset	3133HC STD. .020 .030 .040 .060	2-1.5mm 1-4.0mm Shallow Groove		
V8-302 5.0L 4.0000(IN) 101.6(MM) FORD ENGINE	1987-95 9.1		Hypereutectic. 2.450" dia. head recess .029" deep w/4 valve reliefs. High Output. Similar to 3133H exc. rings. Not intended for Racing applications. STD based on 4.004 bore. COMP HT: 1.600 PIN DIA: .9122 Offset	3165H STD. .020 .030 .040 .060	2-5/64 1-3/16 Shallow Groove 2M5615	FM H654P	
V8-302 5.0L 4.0000(IN) 101.6(MM) FORD ENGINE	1987-95 9.1		Hypereutectic. 2.450" dia. head recess .029" deep w/4 valve reliefs. High Output. *Same as 3165H with "COATED SKIRTS". Not intended for Racing applications. STD based on 4.004 bore. COMP HT: 1.600 PIN DIA: .9122 Offset	3165HC STD. .020 .030 .040 .060	2-5/64 1-3/16 Shallow Groove 2M5615	Similar to 3133H exc. rings. FM H654CP	
V8-302 5.0L 4.0000(IN) 101.6(MM) FORD ENGINE	1996-00 9.0	P	Hypereutectic. Flat head w/4 valve reliefs. "COATED SKIRTS". Not intended for Racing applications. COMP HT: 1.595 PIN DIA: .9122 Offset	3173HC STD. .020 .030 .040 .060	2-1.5mm 1-4.0mm Shallow Groove	F7TZ-6108-FA FM H816CP	



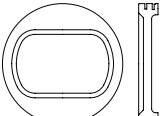

FORD

CYL BORE ENGINE	YEAR COMP. RATIO	VIN CODE	NOTES	PART NO. SIZE	RINGS	O.E. ASSY. NO. INTERCHANGE	HEAD SHAPE
V8-312 5.1L 3.8000(IN) 96.5(MM) FORD ENGINE	1956-60 9.5		Flat head. Floating Pin. COMP HT: 1.760 PIN DIA: .9122 Offset	1066 STD. .020 .030 .040 .060	1-5/64 1-3/32 1-3/16	B6A6108F ECZ6108G-H FM 1031P	
V8-330 5.4L 3.8750(IN) 98.4(MM) FORD ENGINE	1964-78 7.2 7.4		"D" shaped head recess .054" deep. Pin I.D. .700". Truck engine. Medium and Heavy Duty. COMP HT: 1.830 PIN DIA: .9752 Center	1136 STD. .020 .030 .040 .060	1-5/64 1-3/32 1-3/16	C4TZ6108P C4TZ6108CP C8TZ6108G FM 329NP	
V8-330 5.4L 3.5512(IN) 90.2(MM) FORD ENGINE	1997-04 9.0	L	Hypereutectic. 2.710" dia. head recess .068" deep. Truck. *Same as 3160H with "COATED SKIRTS". Floating pin. COMP HT: 1.210 PIN DIA: .8662 Offset	3160HC STD. .25mm .5mm .75mm 1.0mm	2-1.5mm 1-3.0mm	XC3Z6108CA FM H829CP	
V8-330 5.4L 3.5512(IN) 90.2(MM) FORD ENGINE	1997-05 9.0	L M	Hypereutectic. Power Improved. 2.940" dia. head recess .135" deep. "COATED SKIRTS" Floating Pin. COMP HT: 1.210 PIN DIA: .8662 Offset	3190HC STD. .25mm .5mm .75mm 1.0mm	2-1.5mm 1-3.0mm Shallow Groove	FM H877CP	
V8-330 5.4L 3.5512(IN) 90.2(MM) FORD ENGINE	2006-11 9.0	5 V	Hypereutectic, Flat Top .040 Offset Floating Pin "COATED SKIRTS" COMP HT: 1.210 PIN DIA: .8662 Offset Not intended for racing applications	3323HC STD. .25mm .5mm .75mm 1.0mm	2-1.5mm 1-3.0mm	3L3Z-6108-CC 90L93 CASTING H1126CT	
V8-335 5.5L 3.9000(IN) 99.06(MM) FORD ENGINE	1969-95		2.605" dia. head recess .285" deep w/4 valve reliefs. B600 & F600 Truck. COMP HT: 1.739 PIN DIA: .9120 Offset	3163 STD. .020 .030 .040 .060	3-5/64 1-3/16	C9TM-6110-AA	
V8-351C 5.8L 4.0000(IN) 101.6(MM) FORD ENGINE	1970 8.5		Cleveland engine. Flat head w/2 angled valve reliefs. COMP HT: 1.635 PIN DIA: .9122 Offset	1146 STD. .020 .030 .040 .060	2-5/64 1-3/16	DOAZ6108A	
V8-351C 5.8L 4.0000(IN) 101.6(MM) FORD ENGINE	1970 8.5		Hypereutectic, Flat Top 2 Valve Reliefs "COATED SKIRTS" .060 Offset Pin COMP. HT 1.635 PIN DIA: .912 Offset	1146HC STD. .020 .030 .040 .060	2-5/64 1-3/16	D0AZ6108A D0AE6110B FM H555CP	

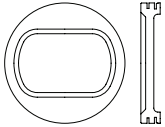
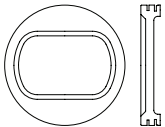
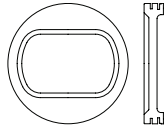
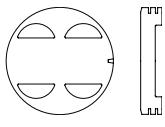
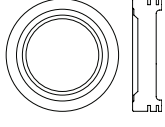
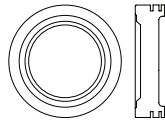
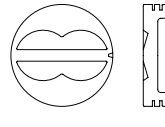
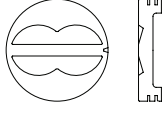
CYL BORE ENGINE	YEAR COMP. RATIO	VIN CODE	NOTES	PART NO. SIZE	RINGS	O.E. ASSY. NO. INTERCHANGE	HEAD SHAPE
V8-351C 5.8L 4.0000(IN) 101.6(MM) AUSTRALIAN FORD ENGINE	8.8		Hypereutectic, Flat Top 2 Valve Reliefs .050 Offset Pin COMP. HT 1.650 PIN DIA: .912 Offset Not intended for racing applications	3329H STD. .020 .030 .040 .060	2-1.5mm 1-4.0mm		
V8-351C 5.8L 4.0000(IN) 101.6(MM) FORD ENGINE	1970-74 7.9		Cleveland engine. 2.750" dia. head recess .060" deep w/2 angled valve reliefs. COMP HT: 1.630 PIN DIA: .9122 Offset	1159 STD. .020 .030 .040 .060	2-5/64 1-3/16	DOAZ6108A-B D3AZ6108N-R FM 425NP	
V8-351M 5.8L 4.0000(IN) 101.6(MM) FORD ENGINE	1975-81 7.9		2.600" dia. head recess .060" deep w/2 angled valve reliefs. COMP HT: 1.921 PIN DIA: .9752 Offset	1167 STD. .020 .030 .040 .060	2-5/64 1-3/16	D5AZ6108A FM 451P	
V8-351W 5.8L 4.0000(IN) 101.6(MM) FORD ENGINE	1969-71 10.5 9.3		Windsor engine. Flat head w/4 valve reliefs. COMP HT: 1.719 PIN DIA: .9122 Offset	1144 STD. .020 .030 .040 .060	2-5/64 1-3/16	C90Z6108A-B FM 336P	
V8-351W 5.8L 4.0000(IN) 101.6(MM) FORD ENGINE	1969-71 10.5 9.3		Hypereutectic. Windsor engine. Flat head w/4 valve reliefs. Coated skirts. COMP HT: 1.719 PIN DIA: .9122 Offset	1144HC STD. .020 .030 .040 .060	2-5/64 1-3/16	 FM H336CP	
V8-351W 5.8L 4.0000(IN) 101.6(MM) FORD ENGINE	1969 7.65		.240 Deep Oblong Dish .060 Offset Pin COMP HT: 1.720 PIN DIA: .912 Offset	3330 STD. .020 .030 .040 .060	2-5/64 1-3/16	D30Z6108G D30E6110AA FM 416P	
V8-351W 5.8L 4.0000(IN) 101.6(MM) FORD ENGINE	1977-93 8.1		Windsor engine. Rectangular head recess .140" deep w/2 valve reliefs. COMP HT: 1.752 PIN DIA: .9122 Offset	1171 STD. .020 .030 .040 .060	2-5/64 1-3/16	D7DZ6108A-B D9AZ6108G-H D30Z6108G-H FM 463P	
V8-351W 5.8L 4.0000(IN) 101.6(MM) FORD ENGINE	1977-93 8.1		Hypereutectic. Windsor engine. Rectangular head recess .140" deep w/2 valve reliefs. Coated skirts. COMP HT: 1.752 PIN DIA: .9122 Offset	1171HC STD. .020 .030 .040 .060	2-5/64 1-3/16		

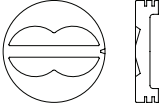
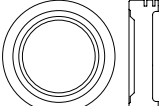
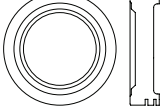
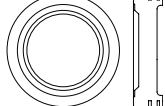
FORD

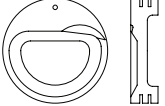
CYL BORE ENGINE	YEAR COMP. RATIO	VIN CODE	NOTES	PART NO. SIZE	RINGS	O.E. ASSY. NO. INTERCHANGE	HEAD SHAPE
V8-351W 5.8L 4.0000(IN) 101.6(MM) FORD ENGINE	1994-97	H	Hypereutectic. Rectangular head recess .180" deep. Lightning Series. Not intended for Racing applications. COMP HT: 1.770 PIN DIA: .9122 Offset	3154H	2-1.5mm 1-4.0mm Shallow Groove	F4TZ6108A FM H621P	
	8.8	STD. .020 .030 .040 .060					
V8-351W 5.8L 4.0000(IN) 101.6(MM) FORD ENGINE	1994-97		Hypereutectic. Rectangular head recess .180" deep. Lightning Series. Similar to 3154H exc. rings. Not intended for Racing applications. COMP HT: 1.770 PIN DIA: .9122 Offset	3166H	2-5/64 1-3/16	FM H653P	
	8.8	STD. .020 .030 .040 .060 .080					
V8-351W 5.8L 4.0000(IN) 101.6(MM) FORD ENGINE	1994-97		Hypereutectic. Rectangular head recess .180" deep. Lightning Series. Similar to 3154H exc. rings. Coated Skirts. COMP HT: 1.770 PIN DIA: .9122 Offset	3166HC	2-5/64 1-3/16	FM H653CP	
	8.8	STD. .020 .030 .040 .060 .080					
V8-352 5.8L 4.0000(IN) 101.6(MM) FORD ENGINE	1958-66		Flat head w/4 valve reliefs. COMP HT: 1.816 PIN DIA: .9752 Offset	1129	1-5/64 1-3/32 1-3/16	B8A6108BA B9A6108BA COAE6108A-B COAZ6108A COAE6108H COAZ6108A FM 246NP	
	9.1	STD. .020 .030 .040 .060					
V8-359 5.9L 4.0500(IN) 102.9(MM) FORD ENGINE	1973-78		Hypereutectic. Stepped head recess. First recess 3.400" dia. x .040" deep. Second recess is 2.880" dia. x .190" deep. Truck engine. Floating Pin. COMP HT: 1.882 PIN DIA: .9752 Offset	3176H	1-3/32 1-5/64 1-3/16	FM H994P	
	7.2	STD. .020 .030 .040 .060					
V8-359 5.9L 4.0500(IN) 102.9(MM) FORD ENGINE	1973-78		Hypereutectic. Stepped head recess. 1 st recess 3.400" dia. x .040" deep. 2 nd recess is 2.880" dia. x .190" deep. Truck engine. Uses 1.0402 pin (NON - FLOATING). COMP HT: 1.882 PIN DIA: 1.0402 Offset	3194H	1-3/32 1-5/64 1-3/16	FM H705P	
	7.2	STD. .020 .030 .040 .060					
V8-360 5.9L 4.0500(IN) 102.9(MM) FORD ENGINE	1968-76		Flat head w/4 valve reliefs. Truck engine. Floating Pin. COMP HT: 1.760 PIN DIA: .9752 Offset	1131	1-5/64 1-3/32 1-3/16	C8TZ6108A	
	8.2	STD. .020 .030 .040 .060					
V8-360 5.9L 4.0500(IN) 102.9(MM) FORD ENGINE	1968-76		Hypereutectic. Flat head w/4 valve reliefs. Truck engine. Not intended for Racing applications. Floating Pin. COMP HT: 1.760 PIN DIA: .9752 Offset	1131H	1-5/64 1-3/32 1-3/16	C8TZ6108A FM H395P	
	8.2	STD. .020 .030 .040 .060					

CYL BORE ENGINE	YEAR COMP. RATIO	VIN CODE	NOTES	PART NO. SIZE	RINGS	O.E. ASSY. NO. INTERCHANGE	HEAD SHAPE
V8-360 5.9L 4.0500(IN) 102.9(MM) FORD ENGINE	1968-76 8.2		Hypereutectic. Flat head w/4 valve reliefs. Uses 1.0402 pin (NON - FLOATING). COMP HT: 1.760 PIN DIA: 1.0402 Offset	3192H STD. .020 .030 .040 .060	1-5/64 1-3/32 1-3/16		
V8-361 5.9L 4.0500(IN) 102.9(MM) FORD ENGINE	1964-78 7.2		2.600" dia.head recess .190" deep. 359/361 truck engine after Engine U40000. 3 ring piston. COMP HT: 1.902 PIN DIA: .9752 Offset	3144D STD. .020 .030 .040 .060	1-3/32 1-5/64 1-3/16 Iron Top Groove	C4TZ6108F C4TZ6108BA C4TZ6108DA D4TZ6108L D4TZ6108L FM H994P	
V8-361 5.9L 4.0500(IN) 102.9(MM) FORD ENGINE	1964-78 7.2		Hypereutectic. Stepped head recess. First recess 3.400" dia. x .040" deep. Second recess is 2.880" dia. x .190" deep. Truck engine. Floating Pin. COMP HT: 1.882 PIN DIA: .9752 Offset	3176H STD. .020 .030 .040 .060	1-3/32 1-5/64 1-3/16	FM H994P	
V8-361 5.9L 4.0500(IN) 102.9(MM) FORD ENGINE	1964-78 7.2		Hypereutectic. Stepped head recess. 1 st recess 3.400" dia. x .040" deep. 2 nd recess is 2.880" dia. x .190" deep. Truck engine. Uses 1.0402 pin (NON - FLOATING). COMP HT: 1.882 PIN DIA: 1.0402 Offset	3194H STD. .020 .030 .040 .060	1-3/32 1-5/64 1-3/16	FM H705P	
V8-370 6.1L 4.0500(IN) 102.9(MM) FORD ENGINE	1979-91 8.0		Flat head w/2 valve reliefs. Truck engine. COMP HT: 2.120 PIN DIA: 1.0402 Offset	1173D STD. .020 .030 .040 .060 .080	1-3/32 1-5/64 1-3/16 Iron Top Groove	D9HZ6108G	
V8-370 6.1L 4.0500(IN) 102.9(MM) FORD ENGINE	1979-91 8.0		Hypereutectic. Flat head w/2 valve reliefs. Truck engine. COMP HT:2.120 PIN DIA: 1.0402 Offset	1173H STD. .020 .030 .040 .060 .080	1-3/32 1-5/64 1-3/16	FM H707P	
V8-370 6.1L 4.0500(IN) 102.9(MM) FORD ENGINE	1979-92		Hypereutectic. "D" Shaped head recess .245" deep with w/1 valve relief. Truck engine. "COATED SKIRTS". COMP HT: 2.120 PIN DIA: 1.0402 Center	3172HC STD. .020 .030 .040 .060	1-3/32 1-5/64 1-3/16	FM HLC702CP	
V8-397 6.2L 4.0160(IN) 102.9(MM) FORD ENGINE	2010-17		Hypereutectic Alloy Anodized Crown and Top Ring Groove Floating Pin SOHC Boss/Raptor COMP HT: 1.310 PIN DIA: 0.9448	3342HCA STD. .25 .50 .75 1.0		AL3Z-6108-K A33KC-T291	

FORD

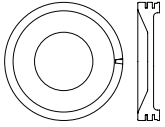
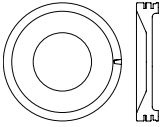
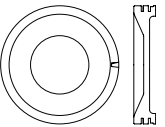
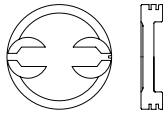
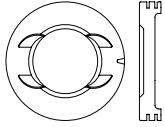
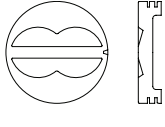
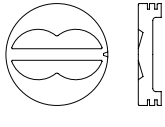
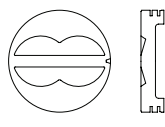
CYL BORE ENGINE	YEAR COMP. RATIO	VIN CODE	NOTES	PART NO. SIZE	RINGS	O.E. ASSY. NO. INTERCHANGE	HEAD SHAPE
V8-389 6.4L 4.0500(IN) 102.9(MM) FORD ENGINE	1964-78 7.2		2.956" dia. head recess .328" deep. FLOATING PIN COMP HT: 1.760 PIN DIA: .9752 Offset	3145D	1-3/32 1-5/64 1-3/16 Iron Top Groove	D5TZ6108A FM 995NP	
				STD. .020 .030 .040 .060			
V8-389 6.4L 4.0500(IN) 102.9(MM) FORD ENGINE	1975-78 7.2		Hypereutectic. 2.950" dia. head recess .330" deep. Truck engine. Floating Pin. COMP HT: 1.739 PIN DIA: .9752 Offset	3177H	1-3/32 1-5/64 1-3/16	FM H995P	
				STD. .020 .030 .040 .060			
V8-389 6.4L 4.0500(IN) 102.9(MM) FORD ENGINE	1975-78 7.2		Hypereutectic. 2.950" dia. head recess .330" deep. Truck engine. Uses 1.0402 pin (NON - FLOATING). COMP HT: 1.739 PIN DIA: 1.0402 Offset	3195H	1-3/32 1-5/64 1-3/16	FM H706P	
				STD. .020 .030 .040 .060			
V8-390 6.4L 4.0500(IN) 102.9(MM) FORD ENGINE	1961-65 9.7		2.690" dia. head recess 0.73" deep w/4 valve reliefs. Floating pin. COMP HT: 1.760 PIN DIA: .9752 Offset	1116	1-5/64 1-3/32 1-3/16	C1AE6108A-B C1AZ6108A-B	
				STD. .020 .030 .040 .060			
V8-390 6.4L 4.0500(IN) 102.9(MM) FORD ENGINE	1966-70 9.5		3.000" dia. head recess .147" deep w/4 valve reliefs. Floating Pin. COMP HT: 1.760 PIN DIA: .9752 Offset	1130	1-5/64 1-3/32 1-3/16	C6AZ6108A C6MY6108K C6AZ6108AG-AH	
				STD. .020 .030 .040 .060 .080			
V8-390 6.4L 4.0500(IN) 102.9(MM) FORD ENGINE	1966-70 10.1		Flat head w/4 valve reliefs. Floating Pin. COMP HT: 1.760 PIN DIA: .9752 Offset	1131	1-5/64 1-3/32 1-3/16	C6AZ6108G C6GY6108A C6AZ6108BG-BH	
				STD. .020 .030 .040 .060			
V8-390 6.4L 4.0500(IN) 102.9(MM) FORD ENGINE	1966-70 10.1		Hypereutectic. Flat head w/4 valve reliefs. Not intended for Racing applications. Floating Pin. COMP HT: 1.760 PIN DIA: .9752 Offset	1131H	1-5/64 1-3/32 1-3/16	C6AZ6108G C6GY6108A C6AZ6108BG-BH FM H395P	
				STD. .020 .030 .040 .060			
V8-390 6.4L 4.0500(IN) 102.9(MM) FORD ENGINE	1966-70 10.1		Hypereutectic. Flat head w/4 valve reliefs. Uses 1.0402 pin (NON - FLOATING). COMP HT: 1.760 PIN DIA: 1.0402 Offset	3192H	1-5/64 1-3/32 1-3/16		
				STD. .020 .030 .040 .060			

CYL BORE ENGINE	YEAR COMP. RATIO	VIN CODE	NOTES	PART NO. SIZE	RINGS	O.E. ASSY. NO. INTERCHANGE	HEAD SHAPE
V8-390 6.4L 4.0500(IN) 102.9(MM) FORD ENGINE	1968-76 8.2		2.620" dia. head recess .075" deep w/4 valve reliefs. Car and truck engine. Floating pin. COMP HT: 1.660 PIN DIA: .9752 Offset	1139 STD. .020 .030 .040 .060	1-5/64 1-3/32 1-3/16	C8TZ6108R D1AZ6108G FM 381NP	
V8-390 6.4L 4.0500(IN) 102.9(MM) FORD ENGINE	1968-76 8.2		2.620" dia. head recess .075" deep w/4 valve reliefs. Uses 1.0402 pin (NON - FLOATING). COMP HT: 1.660 PIN DIA: 1.0402 Offset	3193 STD. .020 .030 .040 .060	1-5/64 1-3/32 1-3/16		
V8-391 6.4L 4.0500(IN) 102.9(MM) FORD ENGINE	1964-78 7.2		Hypereutectic. 2.950" dia. head recess .330" deep. Truck engine. Floating Pin COMP HT: 1.739 PIN DIA: .9752 Offset	3177H STD. .020 .030 .040 .060	1-3/32 1-5/64 1-3/16	FM H995P	
V8-391 6.4L 4.0500(IN) 102.9(MM) FORD ENGINE	1964-78 7.2		Hypereutectic. 2.950" dia. head recess .330" deep. Truck engine. Uses 1.0402 pin (NON - FLOATING). COMP HT: 1.739 PIN DIA: 1.0402 Offset	3195H STD. .020 .030 .040 .060	1-3/32 1-5/64 1-3/16	FM H706P	
V8-391 6.4L 4.0500(IN) 102.9(MM) FORD ENGINE	1975-78 7.2		2.956" dia. head recess .328" deep. COMP HT: 1.760 PIN DIA: .9752 Offset	3145D STD. .020 .030 .040 .060	1-3/32 1-5/64 1-3/16 Iron Top Groove	D5TZ6108A FM H995P	
V8-400 6.6L 4.0000(IN) 101.6(MM) FORD ENGINE	1971-82 7.9		2.944" dia. head recess .115" deep w/2 angled valve reliefs. COMP HT: 1.630 PIN DIA: .9752 Offset	1160 STD. .020 .030 .040 .060	2-5/64 1-3/16	D1AZ6108A-B D2AZ6108G-H D3AZ6108G-H FM 427P	
V10-415 6.8L 3.5512(IN) 90.2(MM) FORD ENGINE	1997-09 9.0	S Y	Hypereutectic. 2.710" dia. head recess .068" deep. Truck engine. *Same as 3161H with "COATED SKIRTS". DFD2 Engine Floating Pin. COMP HT: 1.210 PIN DIA: .8662 Offset	3161HC STD. .25mm .5mm .75mm 1.0mm	2-1.5mm 1-3.0mm	XC3Z6108CA FM H829CP	
V10-415 6.8L 3.5512(IN) 90.2(MM) FORD ENGINE	1997-05 9.0	S	Hypereutectic. Power Improved. 2.940" dia. head recess .135" deep. Coated skirts. Floating Pin. COMP HT: 1.210 PIN DIA: .8662 Offset	3196HC STD. .25mm .5mm .75mm 1.0mm	2-1.5mm 1-3.0mm Shallow Groove	FM H886CP	

FORD

CYL BORE ENGINE	YEAR COMP. RATIO	VIN CODE	NOTES	PART NO. SIZE	RINGS	O.E. ASSY. NO. INTERCHANGE	HEAD SHAPE
V8-421 6.9L 4.0000(IN) 101.6(MM) IHC ENGINE	1984-87 19.7		Truck Diesel. Swirl chamber. (6.6cc cup). B Series. (Supersedes 7085D, different Lockring grooves). Floating Pin. COMP HT: 1.945 PIN DIA: 1.1101 Center	7096D STD. .010 .020 .030 .040 .060	2-5/64 1-7/64 Iron Top Groove	E3TZ6108AA E3TZ6108AF E4TZ6108G 1805212C1 FM H729CP	
V8-428 7.0L 4.1300(IN) 104.9(MM) FORD ENGINE	1966-70 10.3		Cobra Jet. 2.593" dia. head recess .120" deep w/4 valve reliefs. Floating Pin. COMP HT: 1.660 PIN DIA: .9752 Offset	1138 STD. .020 .030 .040 .060	2-5/64 1-3/16	C6AZ6108N C6MY6108G-H C6AZ6108AN-AR C80Z6108G-H C9ZZ6108G-H C9ZZ6108Y-Z FM 354P	
V8-429 7.0L 4.3600(IN) 110.7(MM) FORD ENGINE	1968-73 9.3 8.9 8.0		Oblong head recess .100" deep w/2 angled valve reliefs. COMP HT: 1.882 PIN DIA: 1.0402 Offset	1161 STD. .020 .030 .040 .060	2-5/64 1-3/16	C8SZ6108A-B D2AZ6108A-B D3SZ6108A FM 413AP	
V8-429 7.0L 4.3600(IN) 110.7(MM) FORD ENGINE	1979-90 8.0		Flat head w/2 valve reliefs. Truck engine. COMP HT: 2.140 PIN DIA: 1.0402 Offset	1175D STD. .020 .030 .040 .060	1-3/32 1-5/64 1-3/16 Iron Top Groove	D9HZ6108A FM H723P	
V8-429 7.0L 4.3600(IN) 110.7(MM) FORD ENGINE	1979-92 8.0		Hypereutectic. Flat head with w/2 valve reliefs. Truck engine. "COATED SKIRTS". COMP HT: 2.140 PIN DIA: 1.0402 Offset	3170HC STD. .020 .030 .040 .060	2-5/64 1-3/16	FM H730CP	
V8-429 7.0L 4.3600(IN) 110.7(MM) FORD ENGINE	1979-92 8.0		Hypereutectic. Flat head with w/2 valve reliefs. Truck engine. COMP HT: 2.140 PIN DIA: 1.0402 Offset	3189H STD. .020 .030 .040 .060	1-3/32 1-5/64 1-3/16	FM H723P	
V8-429 7.0L 4.3600(IN) 110.7(MM) FORD ENGINE	1979-92 8.0		Hypereutectic. Flat head w/2 valve reliefs. Truck engine. Coated skirts. COMP HT: 2.140 PIN DIA: 1.0402 Offset	3189HC STD. .020 .030 .040 .060	1-3/32 1-5/64 1-3/16	FM H723CP	
V8-429 7.0L 4.3600(IN) 110.7(MM) FORD ENGINE	1993-98 8.0		Hypereutectic. Flat head with w/2 valve reliefs. Truck engine. COMP HT: 2.140 PIN DIA: 1.0402 Offset	3150H STD. .020 .030 .040 .060	2.0mm 2.0mm 4.0mm Shallow Groove	F5HZ6108AA FM H734P	

CYL BORE ENGINE	YEAR COMP. RATIO	VIN CODE	NOTES	PART NO. SIZE	RINGS	O.E. ASSY. NO. INTERCHANGE	HEAD SHAPE
V8-429 7.0L 4.3600(IN) 110.7(MM) FORD ENGINE	1993-98 8.0		Hypereutectic. Flat head w/2 valve reliefs. Truck engine. Coated skirts. COMP HT: 2.140 PIN DIA: 1.0402 Offset	3150HC STD. .020 .030 .040 .060	2.0mm 2.0mm 4.0mm Shallow Groove	FM H734CP	
V8-445 7.3L 4.1100(IN) 104.4(MM) IHC ENGINE	1989-94 M		Non-Turbo Diesel. Ricardo cup. Truck engine. COMP HT: 1.950 PIN DIA: 1.1101 Center	7098D STD. .010 .020 .030 .040	1-3.0mm 1-2.0mm 1-3.5mm Iron Top Groove	E9TZ6102A F2TZ6102A FM 2745PN	
V8-460 7.5L 4.3600(IN) 110.7(MM) FORD ENGINE	1968-87 8.0		Oblong head recess .230" deep w/2 valve reliefs. Non-EFI. Car & Truck. COMP HT: 1.760 PIN DIA: 1.0402 Offset	1143 STD. .020 .030 .040 .060	2-5/64 1-3/16	C8VY6108A-B D2VY6108A-B D3VY6108A-B	
V8-460 7.5L 4.3600(IN) 110.7(MM) FORD ENGINE	1968-87 8.0		Hypereutectic. Oblong head recess .230" deep w/2 valve reliefs. Non-EFI. Car & Truck. Not intended for Racing applications. *Same as 1143H with "COATED SKIRTS". COMP HT: 1.760 PIN DIA: 1.0402 Offset	1143HC STD. .020 .030 .040 .060	2-5/64 1-3/16	C8VY6108A-B D2VY6108A-B D3VY6108A-B FM H418CP	
V8-460 7.5L 4.3600(IN) 110.7(MM) FORD ENGINE	1988-93 9.7	G	Oblong head recess .072" deep w/2 valve reliefs. EFI. COMP HT: 1.760 PIN DIA: 1.0402 Offset	3109 STD. .020 .030 .040 .060	2-5/64 1-3/16	F2TZ6108A-B E8TZ6108E-G	
V8-460 7.5L 4.3600(IN) 110.7(MM) FORD ENGINE	1988-93 9.7	G	Hypereutectic. Oblong head recess .072" deep w/2 valve reliefs. EFI. COMP HT: 1.760 PIN DIA: 1.0402 Offset	3109H STD. .020 .030 .040 .060	2-5/64 1-3/16	F2TZ6108A-B E8TZ6108E-G FM H582P	
V8-460 7.5L 4.3600(IN) 110.7(MM) FORD ENGINE	1988-93 9.7	G	Hypereutectic. Oblong head recess .072" deep w/2 valve reliefs. EFI. *Same as 3109H with "COATED SKIRTS". Not intended for Racing applications. COMP HT: 1.760 PIN DIA: 1.0402 Offset	3109HC STD. .020 .030 .040 .060	2-5/64 1-3/16	F2TZ6108A-B E8TZ6108E-G FM H582CP	
V8-460 7.5L 4.3600(IN) 110.7(MM) FORD ENGINE	1993-97 8.5	G	Hypereutectic. Oval head recess .180" deep w/2 valve reliefs. Truck or Van engine. COMP HT: 1.770 PIN DIA: 1.0402 Offset	3157H STD. .020 .030 .040 .060	2-2.0mm 1-4.0mm Shallow Groove	F3TZ6108L FM H612P	

FORD

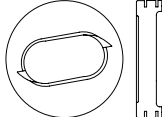
CYL BORE ENGINE	YEAR COMP. RATIO	VIN CODE	NOTES	PART NO. SIZE	RINGS	O.E. ASSY. NO. INTERCHANGE	HEAD SHAPE
V8-460 7.5L 4.3600(IN) 110.7(MM) FORD ENGINE	1993-97 8.5	G	Hypereutectic. Oval head recess .180" deep w/2 valve reliefs. Truck or Van engine. *Same as 3157H with "COATED SKIRTS" COMP HT: 1.770 PIN DIA: 1.0402 Offset	3157HC	2-2.0mm 1-4.0mm Shallow Groove	F3TZ6108L FM H612CP	
				STD. .020 .030 .040 .060			

GENERAL MOTORS

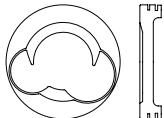
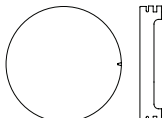
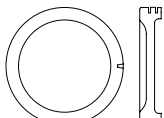
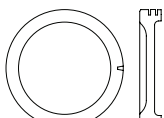
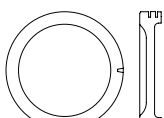
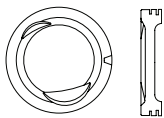
L3-61 1.0L 2.9134(IN) 74.0(MM) SUZUKI ENGINE	1989-98 9.5	6	G10 Engine. Offset head recess .070" deep w/2 valve reliefs. 3 ring piston. Geo Metro, except LSI, FXI. COMP HT: 1.115 PIN DIA: .6695 Offset	3415	1-1.2mm 1-1.5mm 1-2.8mm 3 RING PISTON	96060043 96060039 96060040 96060044 FM 13509P	
				STD. .5mm .75mm 1.0mm			
L4-85.5 1.4L 3.2283(IN) 82.0(MM) CHEVY ENGINE			Flat head. For Brazilian export. COMP HT: 1.475 PIN DIA: .9055 Offset	3412	2-2.0mm 1-4.0mm	94622329	
				STD. .5mm .75mm 1.0mm 1.5mm			
L4-97.6 1.6L 3.2283(IN) 82.0(MM) CHEVY ENGINE			2.750" dia. head. recess .117" deep. Foreign Chevette. COMP HT: 1.307 PIN DIA: .9055 Offset	9082	2-2.0mm 1-4.0mm		
				STD. .5mm .75mm 1.0mm 1.5mm			
L4-97.6 1.6L 3.2283(IN) 82.0(MM) CHEVY ENGINE	1976-78 8.5		2.300" dia. head recess .074" deep. Piston is 2.625" long. *For 1976 replace in full sets only. COMP HT: 1.288 PIN DIA: .9055 Offset	1455	2-1.5mm 1-4.0mm	374040 464217 466323 FM 455P	
				STD. .5mm .75mm 1.0mm 1.5mm			
L4-97.6 1.6L 3.2283(IN) 82.0(MM) CHEVY ENGINE	1979-87 8.6		2.460" dia. head recess .020" deep. Piston is 3.000" long. COMP HT: 1.474 PIN DIA: .9055 Offset	1458	2-1.5mm 1-4.0mm	14001187 14066397 FM 474P	
				STD. .5mm .75mm 1.0mm 1.5mm			
L4-97.6 1.6L 2.9528(IN) 75.0(MM) SUZUKI ENGINE	1989-95 8.9	U 6	Hypereutectic. G16KC engine. 2.346" dia. head recess .120" deep w/2 valve reliefs. Not intended for Racing applications. Floating Pin. COMP HT: 1.103 PIN DIA: .7480 Offset	3414H	1-1.2mm 1-1.5mm 1-2.8mm	96067708 FM H586P	
				STD. .5mm .75mm 1.0mm			

GENERAL MOTORS

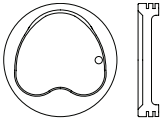
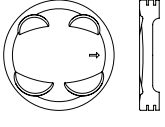
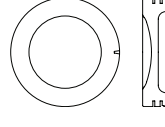
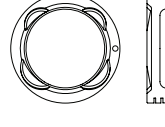
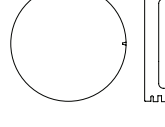
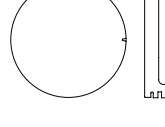
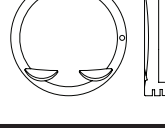
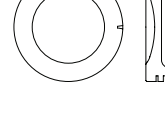
CYL BORE ENGINE	YEAR COMP. RATIO	VIN CODE	NOTES	PART NO. SIZE	RINGS	O.E. ASSY. NO. INTERCHANGE	HEAD SHAPE
L4-97.6 1.6L 3.1890(IN) 81.0(MM) TOYOTA ENGINE	1983-88 9.0		4ALC engine. Heart shaped head recess .129" deep. COMP HT: 1.193 PIN DIA: .7090 Offset	9066 STD. .5mm .75mm 1.0mm	2-1.5mm 1-2.8mm	13101-16010-2 94840037 FM 12324P	
L4-97.6 1.6L 3.1890(IN) 81.0(MM) TOYOTA ENGINE	1992-97 9.5		4AFE DOHC engine. 2.680" dia. head recess .100" deep w/4 valve reliefs. COMP HT: 1.190 PIN DIA: .7875 Offset	9109 STD. .5mm .75mm 1.0mm	1-1.2mm 1-1.5mm 1-3.0mm	13101-16160-01	
L4-110 1.8L 3.3071(IN) 84.0(MM) ISUZU ENGINE	1976-82 8.4		2.800" dia. head recess .068" deep. LUV Series 5, 6, 8, 9, 10, 11 & 12. COMP HT: 1.435 PIN DIA: .8665 Offset	1462 STD. .5mm .75mm 1.0mm 1.5mm	2-2.0mm 1-4.0mm	94201040 94215088 94238475 FM 480P	
L4-110 1.8L 3.1890(IN) 81.0(MM) TOYOTA ENGINE	1993-97 9.5		7AFE engine. DOHC. 2.650" dia. head recess .130" deep w/4 valve reliefs. COMP HT: 1.190 PIN DIA: .7875 Offset	9107 STD. .5mm .75mm 1.0mm	1-1.2mm 1-1.5mm 1-3.0mm	13101-16150-01 FM 13504P	
L4-112 1.8L 3.5039(IN) 89.0(MM) CHEVY ENGINE	1982 8.5		Flat head. 2nd design with 1.5mm top ring. COMP HT: 1.578 PIN DIA: .9055 Offset	3443 STD. .5mm .75mm 1.0mm 1.5mm	1-1.5mm 1-2.0mm 1-4.75mm	14033250 14003994 FM 642P	
L4-112 1.8L 3.5039(IN) 89.0(MM) CHEVY ENGINE	1982 8.5		Flat head. 2nd design with 1.5mm top ring. *Same as 3443 with "COATED SKIRTS". COMP HT: 1.578 PIN DIA: .9055 Offset	3443C STD. .5mm .75mm 1.0mm 1.5mm	1-1.5mm 1-2.0mm 1-4.75mm	14033250 14003994	
L4-116 1.9L 3.2283(IN) 82.0(MM) SATURN ENGINE	1991-93 9.5	7 9	Hypereutectic. DOHC. 2.700" dia. head recess .110" deep w/2 valve reliefs. "COATED SKIRTS". Not intended for Racing applications. Floating Pin. COMP HT: 1.165 PIN DIA: .7677 Offset	1901HC STD. .5mm .75mm 1.0mm	2-1.5mm 1-3.0mm	FM H846CP	
L4-116 1.9L 3.2283(IN) 82.0(MM) SATURN ENGINE	1991-98 9.3		Hypereutectic. SOHC. 2.000" dia. head recess .220" deep. Use early style ring pack. "COATED SKIRTS". Not intended for Racing applications. Floating Pin. COMP HT: 1.165 PIN DIA: .7677 Offset	1900HC STD. .5mm .75mm 1.0mm	2-1.5mm 1-3.0mm 91-93 Ring Pack	FM H844CP	

GENERAL MOTORS

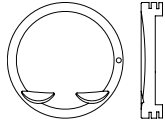
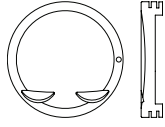
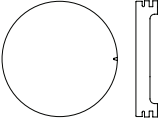
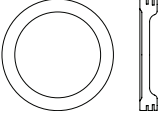
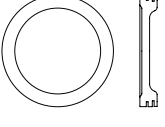
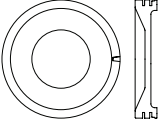
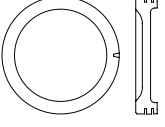
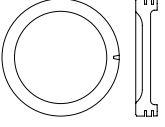
CYL BORE ENGINE	YEAR COMP. RATIO	VIN CODE	NOTES	PART NO. SIZE	RINGS	O.E. ASSY. NO. INTERCHANGE	HEAD SHAPE
L4-116 1.9L 3.2283(IN) 82.0(MM) SATURN ENGINE	1994-98 9.5	7 9	Hypereutectic. DOHC. 2.700" dia. head recess .060" deep w/2 valve reliefs. "COATED SKIRTS". Not intended for Racing applications. Floating Pin. COMP HT: 1.165 PIN DIA: .7677 Offset	1902HC STD. .5mm .75mm 1.0mm	1-1.2mm 1-1.5mm 1-3.0mm Shallow Groove	21006738 FM H845CP	
L4-116 1.9L 3.2283(IN) 82.0(MM) SATURN ENGINE	1999-02 9.3	7	Hypereutectic. 2.650" dia. head recess .060" deep w/2 valve reliefs. Coated skirts. Floating Pin. COMP HT: 1.034 PIN DIA: .7677 Offset	1903HC STD. .5mm .75mm 1.0mm	1-1.2mm 1-1.5mm 1-2.5mm Shallow Groove	25008578 FM H1118 CP	
L4-119 1.9L 3.4252(IN) 87.0(MM) ISUZU ENGINE	1982-85 8.4		Flat head. LR1 engine. 22mm pin. *Use 1982 ring pack for all years. COMP HT: 1.438 PIN DIA: .8665 Offset	1461 STD. .5mm .75mm 1.0mm	2-2.0mm 1-4.0mm *1982 Ring Pack	94213831 94237469 FM 12216P	
L4-121 2.0L 3.5039(IN) 89.0(MM) CHEVY ENGINE	1983-84 9.3		2.250" dia. head recess .155" deep. Full sets only. COMP HT: 1.578 PIN DIA: .9055 Offset	1468 STD. .5mm .75mm 1.0mm 1.5mm	1-1.5mm 1-2.0mm 1-4.75mm	14057958 14057964 FM 493NP	
L4-121 2.0L 3.5039(IN) 89.0(MM) CHEVY ENGINE	1985-86 9.0		2.370" dia. head recess .155" deep. Small pin. COMP HT: 1.578 PIN DIA: .8002 Offset	1469 STD. .5mm .75mm 1.0mm 1.5mm	2-1.5mm 1-4.75mm Shallow Groove	14079572 10103570 FM 515P	
L4-121 2.0L 3.5039(IN) 89.0(MM) CHEVY ENGINE	1987-89 9.0	1	2.670" dia. head recess .295" deep. EFI. Small pin. COMP HT: 1.330 PIN DIA: .8002 Offset	1481 STD. .5mm .75mm 1.0mm 1.5mm	2-1.5mm 1-3.0mm Shallow Groove	14090009 10112366 10067349 FM 540P	
L4-121 2.0L 3.3858(IN) 86.0(MM) PONTIAC ENGINE	1987-90 8.0	K	Hypereutectic. 2.750" dia. head recess .210" deep. Turbo. Not intended for Racing applications. COMP HT: 1.171 PIN DIA: .8271 Offset	1538H STD. .5mm .75mm 1.0mm	2-1.5mm 1-3.0mm Shallow Groove	52273302 FM H560P	
L4-121 2.0L 3.3858(IN) 86.0(MM) PONTIAC ENGINE	1987-91 8.8	K	Hypereutectic. 2.780" dia. head recess .142" deep. Non-turbo. Not intended for Racing applications. COMP HT: 1.171 PIN DIA: .8271 Offset	1536H STD. .5mm .75mm 1.0mm	2-1.5mm 1-3.0mm Shallow Groove	52273299 FM H565P	

GENERAL MOTORS

CYL BORE ENGINE	YEAR COMP. RATIO	VIN CODE	NOTES	PART NO. SIZE	RINGS	O.E. ASSY. NO. INTERCHANGE	HEAD SHAPE
L4-121 2.0L 3.3858(IN) 86.0(MM) PONTIAC ENGINE	1992-94 9.2	H	Hypereutectic. 2.230" dia. offset head recess .190" deep. Non-turbo. Not intended for Racing applications. COMP HT: 1.171 PIN DIA: .8271 Offset	1537H STD. .5mm .75mm 1.0mm	2-1.5mm 1-3.0mm Shallow Groove	52269890 FM H821P	
L4-121 2.0L 3.3858(IN) 86.0(MM) PONTIAC ENGINE	1992-94 9.2	H	Hypereutectic. 2.230" dia. offset head recess .190" deep. Non-turbo. Coated skirts. COMP HT: 1.171 PIN DIA: .8271 Offset	1537HC STD. .5mm .75mm 1.0mm	2-1.5mm 1-3.0mm Shallow Groove	FM H821CP	
L4-134 2.2L 3.5039(IN) 89.0(MM) CHEVY ENGINE	1990-94 9.0	G 4	2.875" dia. head recess .210" deep. COMP HT: 1.170 PIN DIA: .8002 Offset	1488 STD. .5mm .75mm 1.0mm	2-1.5mm 1-3.0mm	10101244 10103688 10156056 FM 569P	
L4-134 2.2L 3.5039(IN) 89.0(MM) CHEVY ENGINE	1992-97 9.0	4	2.940" dia. head recess .200" deep. Truck & passanger. COMP HT: 1.170 PIN DIA: .8002 Offset	3422 STD. .5mm .75mm 1.0mm 1.5mm	2-1.5mm 1-3.0mm	10141960	
L4-134 2.2L 3.5039(IN) 89.0(MM) CHEVY ENGINE	1992-97 9.0	4	Hypereutectic. 2.940" dia. head recess .200" deep. Truck & passanger. Not intended for Racing applications. COMP HT: 1.170 PIN DIA: .8002 Offset	3422H STD. .5mm .75mm 1.0mm 1.5mm	2-1.5mm 1-3.0mm	10141960 FM H637ACP	
L4-134 2.2L 3.5039(IN) 89.0(MM) CHEVY ENGINE	1992-97 9.0	4	Hypereutectic. 2.940" dia. head recess .200" deep. Truck & passanger. Not intended for Racing applications. "COATED SKIRTS". COMP HT: 1.170 PIN DIA: .8002 Offset	3422HC STD. .5mm .75mm 1.0mm 1.5mm	2-1.5mm 1-3.0mm	10141960 FM H637AP	
L4-134 2.2L 3.5039(IN) 89.0(MM) CHEVY ENGINE	1998-03 8.85	4	Hypereutectic. 2.650" dia. head recess .065" deep. Not intended for Racing applications. COMP HT: 1.200 PIN DIA: .8002 Offset	3478HC STD. .5mm .75mm 1.0mm	2-1.5mm 1-3.0mm	24577467 FM H851CP	
L4-134 2.2L 3.3858(IN) 86.0(MM) ECOTEC ENGINE	2002-06 9.4	6 F	Hypereutectic. 2.750" dia. head recess .025" deep. Coated skirts. Floating Pin. VUE, ION COMP HT: 1.044 PIN DIA: .7874 Offset	3495HC STD. .5mm .75mm 1.0mm	1-1.2mm 1-1.5mm 1-2.5mm Shallow Groove	12591087 FM H1120CT	

GENERAL MOTORS

CYL BORE ENGINE	YEAR COMP. RATIO	VIN CODE	NOTES	PART NO. SIZE	RINGS	O.E. ASSY. NO. INTERCHANGE	HEAD SHAPE
L4-138 2.3L 3.6220(IN) 92.0(MM) OLDSMOBILE ENGINE	1988-94 9.1	A D G 3	Hypereutectic. Quad-4 engine. 2.876" dia. head recess .136" deep w/4 valve reliefs. Not intended for Racing applications. COMP HT: 1.240 PIN DIA: .8665 Offset	1642H STD. .25mm .5mm .75mm 1.0mm 1.5mm	2-1.5mm 1-3.0mm	24573576 FM H566P	
NEW L4-146 2.4 L 3.4646(IN) 88(MM) GM ECOTEC ENGINE	2005-15 10	B, C, O, P, U, V, W, Z, 1, 5	DOHC 4 cyl. Ecotec, Cobalt, HHR, G6. Floating pin. Anodized crown and top ring groove. Hastings 2C4564 COMP HT: 1.082 PIN DIA: .787 Offset	3537HCA STD. .10mm .25mm .50mm .75mm 1.0mm	1-1.2mm 1-1.5mm 1-2.0mm	12646457	
L4-146 2.4L 3.5433(IN) 90.0(MM) OLDSMOBILE ENGINE	1996-98 9.5	T	Hypereutectic. 2.400" dia. head recess .070" deep. Not intended for Racing applications. COMP HT: 1.170 PIN DIA: .8661 Offset	3442H STD. .5mm .75mm 1.0mm	1-1.2mm 1-1.5mm 1-3.0mm	24575963 FM H837P	
L4-146 2.4L 3.5433(IN) 90.0(MM) OLDSMOBILE ENGINE	1996-98 9.5	T	Hypereutectic. 2.400" dia. head recess .070" deep. Coated skirts. COMP HT: 1.170 PIN DIA: .8661 Offset	3442HC STD. .5mm .75mm 1.0mm	1-1.2mm 1-1.5mm 1-3.0mm Shallow Groove	FM H837CP	
L4-151 2.5L 4.0000(IN) 101.6(MM) PONTIAC ENGINE	1977-78 8.1		Flat head. COMP HT: 1.570 PIN DIA: .9273 Offset	1539 STD. .020 .030 .040 .060	2-5/64 1-3/16	547147 FM 457P	
L4-151 2.5L 4.0000(IN) 101.6(MM) PONTIAC ENGINE	1979-86 8.2		3.020" dia. head recess .226" deep. Replace in full sets only. COMP HT: 1.570 PIN DIA: .9273 Offset	1528 STD. .020 .030 .040 .060	2-5/64 1-3/16	10010398 10010404 10017714 10020963 10021844 10024243 10027416 10027317 10032144 FM 465AP	
L4-151 2.5L 4.0000(IN) 101.6(MM) PONTIAC ENGINE	1979-86 8.2		Hypereutectic. 3.020" dia. head recess .226" deep. Replace in full sets only. "COATED SKIRTS". Not intended for Racing applications. COMP HT: 1.570 PIN DIA: .9273 Offset	1528HC STD. .020 .030 .040 .060	2-5/64, 1-3/16	10010398 10010404 10017714 10020963 10021844 10024243 10027416 10027317 10032144 FM H553CP	
L4-151 2.5L 4.0000(IN) 101.6(MM) PONTIAC ENGINE	1979-86 8.5		Hypereutectic. 3.100" dia. head recess .220" deep. Coated skirts. COMP HT: 1.570 PIN DIA: .9273 Offset	1540HC STD. .020 .030 .040 .060 .065	2-5/64 1-3/16	FM H553CP	

GENERAL MOTORS

CYL BORE ENGINE	YEAR COMP. RATIO	VIN CODE	NOTES	PART NO. SIZE	RINGS	O.E. ASSY. NO. INTERCHANGE	HEAD SHAPE
L4-151 2.5L 4.0000(IN) 101.6(MM) PONTIAC ENGINE	1979-93 9.0 8.3	A R	Hypereutectic. 3.100" dia. head recess .145" deep. Full sets only. Not intended for Racing applications. COMP HT: 1.566 PIN DIA: .9273 Offset	1533H STD. .020 .030 .040 .060	1-1/16 1-5/64, 1-3/16 Shallow Groove	10101488 10044245 10112445 10112444 10042191 10101488 FM H547P	
L4-151 2.5L 4.0000(IN) 101.6(MM) PONTIAC ENGINE	1979-93 9.0 8.3	A R	Hypereutectic. 3.100" dia. head recess .145" deep. Full sets only. *Same as 1533H with "COATED SKIRTS". Not intended for Racing applications. COMP HT: 1.566 PIN DIA: .9273 Offset	1533HC STD. .020 .030 .040 .060	1-1/16 1-5/64, 1-3/16 Shallow Groove	10101488 10044245 10112445 10112444 10042191 10101488 FM H547CP	
L4-151 2.5L 4.0000(IN) 101.6(MM) PONTIAC ENGINE	1982-86 9.0		3.070" dia. head recess .226" deep. Replace in full sets only. COMP HT: 1.570 PIN DIA: .9273 Offset	1532 STD. .020 .030 .040 .060	1-1/16 1-5/64 1-3/16 Shallow Groove	10027317 FM 498NP	
L4-153 2.5L 3.8750(IN) 98.4(MM) CHEVY ENGINE	1962-70 8.5		Flat head w/4 valve reliefs. COMP HT: 1.779 PIN DIA: .9273 Offset	3486 STD. .020 .030 .040 .060 .080	2-5/64, 1-3/16	3792534 3840148 3860407 FM 235NP	
L4-171 2.8L 3.6614(IN) 93.0(MM) GM ENGINE	2004-05 10.1	8	Hypereutectic. 0.95" high dome. Coated skirts. Floating Pin. COMP HT: 1.101 PIN DIA: .9054 Offset	3511HC STD. .5mm .75mm 1.0mm	1-1.2mm 1-1.5mm 1-2.5mm Shallow Groove	12585784	
V6-173 2.8L 3.5039(IN) 89.0(MM) CHEVY ENGINE	1980-88 8.5		Flat head. 2nd design with 1.5mm top ring. COMP HT: 1.578 PIN DIA: .9055 Offset	1463 STD. .25mm .5mm .75mm 1.0mm 1.5mm	1-1.5mm 1-2.0mm 1-4.75mm	14033250 14003994 FM 464P	
V6-173 2.8L 3.5039(IN) 89.0(MM) CHEVY ENGINE	1980-88 8.5		Flat head. 2nd design with 1.5mm top ring. *Same as 1463 with "COATED SKIRTS". COMP HT: 1.578 PIN DIA: .9055 Offset	1463C STD. .25mm .5mm .75mm 1.0mm 1.5mm	1-1.5mm 1-2.0mm 1-4.75mm	14033250 14003994 FM 464CP	
V6-173 2.8L 3.5039(IN) 89.0(MM) CHEVY ENGINE	1985-93 8.5	R	Flat head. COMP HT: 1.599 PIN DIA: .9055 Offset	1478 STD. .5mm .75mm 1.0mm 1.5mm	1-1.5mm 1-2.0mm 1-4.75mm Shallow Groove	14092910 FM 516P	

GENERAL MOTORS

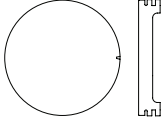
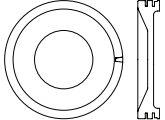
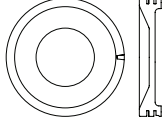
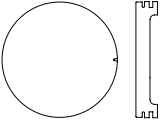
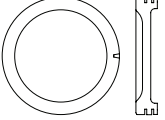
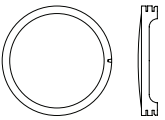
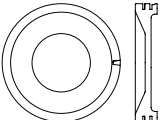
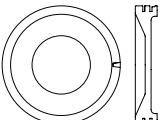
CYL BORE ENGINE	YEAR COMP. RATIO	VIN CODE	NOTES	PART NO. SIZE	RINGS	O.E. ASSY. NO. INTERCHANGE	HEAD SHAPE
V6-173 2.8L 3.5039(IN) 89.0(MM) CHEVY ENGINE	1985-93 8.5	R	Flat head. Similar to 1463 except ring pack. *Same as 1478 with "COATED SKIRTS". COMP HT: 1.599 PIN DIA: .9055 Offset	1478C STD. .5mm .75mm 1.0mm 1.5mm	1-1.5mm 1-2.0mm 1-4.75mm Shallow Groove	14092910 FM 516CP	
V6-173 2.8L 3.5039(IN) 89.0(MM) CHEVY ENGINE	1988-89 8.9		2.470" dia. head recess .270" deep. COMP HT: 1.608 PIN DIA: .9054 Offset	1492 STD. .5mm .75mm 1.0mm 1.5mm	2-1.5mm 1-4.0mm Shallow Groove	14102688 FM 531P	
V6-173 2.8L 3.5039(IN) 89.0(MM) CHEVY ENGINE	1988-89 8.9		2.470" dia. head recess .270" deep. *Same as 1492 with "COATED SKIRTS". COMP HT: 1.608 PIN DIA: .9054 Offset	1492C STD. .5mm .75mm 1.0mm 1.5mm	2-1.5mm 1-4.0mm Shallow Groove	14102688 FM 531CP	
V6-181 3.0L 3.8000(IN) 96.52(MM) BUICK ENGINE	1982-87 8.5		LK9 engine. Flat head. 1985 high deck engines. Used in "C" cars only. COMP HT: 1.808 PIN DIA: .9398 Offset	1734 STD. .020 .030 .040 .060	2-5/64, 1-3/16	25511557 25516698 FM 496P	
V6-181 3.0L 3.8000(IN) 96.52(MM) BUICK ENGINE	1985-88 9.0	L	LN7 engine. 2.490" dia. head recess .160" deep. Low deck. M.F.I. COMP HT: 1.805 PIN DIA: .9398 Offset	1736 STD. .020 .030 .040 .060	2-5/64, 1-3/16	25522584 FM 590P	
V6-181 3.0L 3.3858(IN) 86.0(MM) CADILLAC ENGINE	1997-01 2000-05 2002-03 10.1	R	.102" high spherical dome. Replaces pistons stamped "02". Catera, Saturn-L, VUE Floating Pin. COMP HT: 1.089 PIN DIA: .8266 Offset	1825 STD. .5mm .75mm 1.0mm	1-1.2mm 1-1.5mm 1-3.0mm Shallow Groove	90571288 FM 887P	
V6-191 3.1L 3.5039(IN) 89.0(MM) CHEVY ENGINE	1988-95 8.8	M T W	2.880" dia. head recess .272" deep. Aluminum Head. Lumina. COMP HT: 1.450 PIN DIA: .9054 Offset	1496 STD. .5mm .75mm 1.0mm 1.5mm	2-1.5mm 1-4.0mm Shallow Groove	10070183 10146881	
V6-191 3.1L 3.5039(IN) 89.0(MM) CHEVY ENGINE	1988-95 8.8	M T W	Hypereutectic. 2.880" dia. head recess .272" deep. Aluminum Head. Lumina. *Same as 1496H with "COATED SKIRTS". Not intended for Racing applications. COMP HT: 1.450 PIN DIA: .9054 Offset	1496HC STD. .5mm .75mm 1.0mm 1.5mm	2-1.5mm 1-4.0mm Shallow Groove	10070183 10146881 FM H561CP	

GENERAL MOTORS

CYL BORE ENGINE	YEAR COMP. RATIO	VIN CODE	NOTES	PART NO. SIZE	RINGS	O.E. ASSY. NO. INTERCHANGE	HEAD SHAPE
V6-191 3.1L 3.5039(IN) 89.0(MM) CHEVY ENGINE	1990-95 8.8	D T	2.950" dia. head recess .105" deep. Iron Head. TBI. APV only. COMP HT: 1.450 PIN DIA: .9054 Offset	1486	2-1.5mm 1-4.0mm Shallow Groove	10070145 10087699	
				STD. .5mm .75mm 1.0mm 1.5mm			
V6-191 3.1L 3.5039(IN) 89.0(MM) CHEVY ENGINE	1990-95 8.8	D T	Hypereutectic. 2.950" dia. head recess .105" deep. Iron Head. TBI. APV only. "COATED SKIRTS". Not intended for Racing applications. COMP HT: 1.450 PIN DIA: .9054 Offset	1486HC	2-1.5mm 1-4.0mm Shallow Groove	10070145 10087699 FM H562CP	
				STD. .5mm .75mm 1.0mm 1.5mm			
V6-191 3.1L 3.5039(IN) 89.0(MM) CHEVY ENGINE	1994-96 9.5	M	Hypereutectic. 2.825" dia. head recess .279" deep. "COATED SKIRTS". Not intended for Racing applications. COMP HT: 1.470 PIN DIA: .9054 Offset	3477HC	2-1.5mm 1-4.0mm Shallow Groove	24505806 FM H692CP	
				STD. .5mm .75mm 1.0mm 1.5mm			
V6-191 3.1L 3.5039(IN) 89.0(MM) CHEVY ENGINE	1996-06 9.5	M	2.825" dia. head recess .258" deep. "COATED SKIRTS". COMP HT: 1.478 PIN DIA: .9054 Offset	3459C	1-1.2mm 1-1.5mm 1-3.0mm Shallow Groove	24508726	
				STD. .5mm .75mm 1.0mm 1.5mm			
V6-191 3.1L 3.5039(IN) 89.0(MM) CHEVY ENGINE	1996-06 9.5	M	Hypereutectic. 2.825" dia. head recess .258" deep. "COATED SKIRTS". Not intended for Racing applications. COMP HT: 1.478 PIN DIA: .9054 Offset	3459HC	1-1.2mm 1-1.5mm 1-3.0mm Shallow Groove	24508726 FM H809CP	
				STD. .5mm .75mm 1.0mm 1.5mm			
V6-191 3.1L 3.5039(IN) 89.0(MM) GM ENGINE	1999-03 9.5	J	Hypereutectic. 2.740" dia. head recess .260" deep. Coated skirts. COMP HT: 1.467 PIN DIA: .9054 Offset	3512HC	1-1.2mm 1-1.5mm 1-3.0mm	12564009 FM H882CP	
				STD. .5mm .75mm 1.0mm 1.5mm			
V6-200 3.3L 3.5000(IN) 88.9(MM) CHEVY ENGINE	1978-79 8.2		2.840" dia. head recess .120" deep. COMP HT: 1.540 PIN DIA: .9273 Offset	1456	2-5/64, 1-3/16	462636 FM 475NP	
				STD. .020 .030 .040 .060			
V6-204 3.3L 3.7000(IN) 93.98(MM) BUICK ENGINE	1989-93 9.0	N	Hypereutectic. 2.830" dia. head recess .123" deep. Not intended for Racing applications. COMP HT: 1.310 PIN DIA: .9054 Offset	1743H	2-1.5mm 1-3.0mm Shallow Groove	25535356 24501065 FM H564P	
				STD. .5mm .75mm 1.0mm			

GENERAL MOTORS

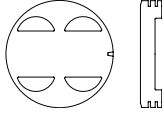
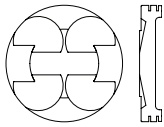
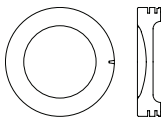
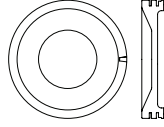
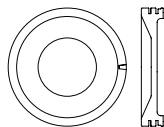
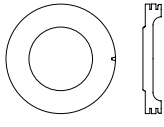
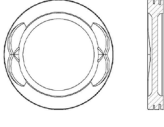
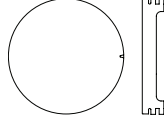
CYL BORE ENGINE	YEAR COMP. RATIO	VIN CODE	NOTES	PART NO. SIZE	RINGS	O.E. ASSY. NO. INTERCHANGE	HEAD SHAPE
V6-207 3.4L 3.6220(IN) 92.0(MM) CHEVY ENGINE	1991-95 9.3	X	Flat head w/4 valve reliefs. COMP HT: 1.457 PIN DIA: .9055 Offset	3409 STD. .5mm .75mm 1.0mm 1.5mm	2-1.5mm 1-4.0mm	10130903L 10130904R	
V6-207 3.4L 3.6220(IN) 92.0(MM) CHEVY ENGINE	1991-97		Hypereutectic. .040" Dome w/4 valve reliefs. "COATED SKIRTS". Not intended for Racing applications. COMP HT: 1.464 PIN DIA: .9054 Offset	3483HC STD. .5mm .75mm 1.0mm	1-1.2mm 1-1.5mm 1-3.0mm Shallow Groove	24505686 FM H684CP	
V6-207 3.4L 3.6220(IN) 92.0(MM) CHEVY ENGINE	1993-95 9.25	S	Hypereutectic. 2.750" dia. head recess .080" deep. Not intended for Racing applications. COMP HT: 1.457 PIN DIA: .9054 Offset	3420H STD. .5mm .75mm 1.0mm	2-1.5mm 1-4.0mm Shallow Groove	10146858 FM H800P	
V6-207 3.4L 3.6220(IN) 92.0(MM) CHEVY ENGINE	1996-03 06-09 9.5	E F	3.140" dia. head recess .270" deep. COMP HT: 1.470 PIN DIA: .9054 Offset	3439 STD. .5mm .75mm 1.0mm 1.5mm	1-1.2mm 1-1.5mm 1-4.0mm Shallow Groove	24508727	
V6-207 3.4L 3.6220(IN) 92.0(MM) CHEVY ENGINE	1996-09 9.5	E	Hypereutectic. 3.140" dia. head recess .270" deep. "COATED SKIRTS". Not intended for Racing applications. Equinox. COMP HT: 1.470 PIN DIA: .9054 Offset	3439HC STD. .5mm .75mm 1.0mm 1.5mm	1-1.2mm 1-1.5mm 1-4.0mm Shallow Groove	24508727 FM H847CP	
L5-211 3.5L 3.6614(IN) 93.0(MM) GM ENGINE	2004-06 10.0	6	Hypereutectic. 0.95" high dome. Coated skirts. Floating Pin. COMP HT: 1.101 PIN DIA: .9054 Offset	3510HC STD. .5mm .75mm 1.0mm	1-1.2mm 1-1.5mm 1-2.5mm Shallow Groove	12585784	
V6-214 3.5L 3.8976(IN) 99(MM) GM ENGINE	2009	K N	Hypereutectic. 2.920" dia. head recesses .154" deep. Four valve relief. Coated skirts. Floating Pin. COMP HT: 1.295 PIN DIA: .0943 Offset	3525HC STD. .05mm .75mm 1.0mm	1-1.2mm 1-1.5mm 1-2.5mm Shallow Groove	8901865	
V6-214 3.5L 3.5236(IN) 89.5(MM) OLDSMOBILE ENGINE	1999-02 9.3	H	Hypereutectic. Flat head. Coated skirts. Floating Pin. COMP HT: 1.094 PIN DIA: .8266 Offset	3460HC STD. .5mm .75mm 1.0mm	1-1.2mm 1-1.5mm 1-2.5mm Shallow Groove	12560544 FM H1131CT	

3.6L 2004-11 Vin 7, D, V LY7 Engine

SEE HOLDEN PAGE 78

GENERAL MOTORS

CYL BORE ENGINE	YEAR COMP. RATIO	VIN CODE	NOTES	PART NO. SIZE	RINGS	O.E. ASSY. NO. INTERCHANGE	HEAD SHAPE
V8-215 3.5L 3.5000(IN) 88.9(MM) BUICK ENGINE	1961-63 8.8		2.812" dia. head recess .150" deep. COMP HT: 1.843 PIN DIA: .8750 Center	1718 STD. .020 .030 .040 .060	2-5/64, 1-3/16	1389184 1399081 FM 71P	
NEW V6-217 3.6L 3.7008(IN) 94(MM) GM LLT ENGINE	2007-17 11.3	D, V	Hypereutectic with coated skirts. ANODIZED CROWN AND TOP RING GROOVE. Direct injection GDI, DOHC. Engine Code LLT COMP HT: 1.172 PIN DIA: .945 Centered	3538HCA STD. .10mm .25mm .50mm .75mm	1-1.2mm 1-1.5mm 1-2.5mm Hastings 2M5133	12616972	
NEW V6-217 3.6L 3.7008(IN) 94(MM) GM LFX ENGINE	2012-18 11.5	D, V	Hypereutectic with coated skirts. ANODIZED CROWN AND TOP RING GROOVE. Direct injection GDI, DOHC. Engine Code LFX COMP HT: 1.172 PIN DIA: .945 Centered	3539HCA STD. .10mm .25mm .50mm .75mm	1-1.2mm 1-1.5mm 1-2.5mm Hastings 2M5133	126254950	
V6-220 3.6L 3.7008(IN) 94.0(MM) BUICK HOLDEN ENGINE	2004-11	7 D V	Hypereutectic, Flat Top 4 Valve Reliefs .030 Offset Floating Pin "COATED SKIRTS" LY7 Engine. COMP HT: 1.262 PIN DIA: .944 Offset	1758HC STD. .25mm .5mm .75mm 1.0mm	1-1.2mm 1-1.5mm 1-2.5mm	RP3600S	
V6-225 3.7L 3.7500(IN) 95.25(MM) BUICK ENGINE	1964-67 8.3		3.060" dia. head recess .230" deep. COMP HT: 1.835 PIN DIA: .9398 Offset	1748 STD. .020 .030 .040 .060	2-5/64, 1-3/16	1399524 FM 279P	
V6-229 3.8L 3.7360(IN) 94.9(MM) CHEVY ENGINE	1980-84 9.5		Flat head w/4 valve reliefs. COMP HT: 1.540 PIN DIA: .9273 Offset	3466 STD. .020 .030 .040 .060	2-5/64, 1-3/16	14044649 14081291 FM 534NP	
V6-229 3.8L 3.7360(IN) 94.9(MM) CHEVY ENGINE	1980-84 9.5		Hypereutectic. Flat head w/4 valve reliefs. Not intended for Racing applications. De-Stroke .020" from FM numbers COMP HT: 1.540 PIN DIA: .9273 Offset	3467H STD. .020 .030 .040 .060	2-5/64, 1-3/16	14044649 14081291 FM H534P FM H643P	
V6-229 3.8L 3.7360(IN) 94.9(MM) CHEVY ENGINE	1980-86 8.6		3.160" dia. head recess .09" deep. COMP HT: 1.540 PIN DIA: .9273 Offset	3444 STD. .020 .030 .040 .060	2-5/64, 1-3/16	14019883 364702 FM 698P	

GENERAL MOTORS

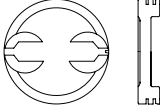
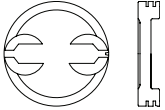
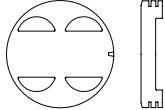
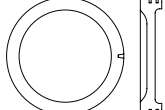
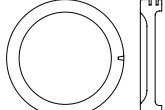
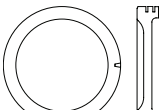
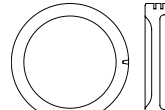
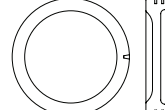
CYL BORE ENGINE	YEAR COMP. RATIO	VIN CODE	NOTES	PART NO. SIZE	RINGS	O.E. ASSY. NO. INTERCHANGE	HEAD SHAPE
V6-229 3.8L 3.7360(IN) 94.9(MM) CHEVY ENGINE	1987-94 8.6		3.100" dia. head recess .040" deep w/4 valve reliefs. COMP HT: 1.540 PIN DIA: .9273 Offset	3492	2-5/64, 1-3/16	14019883 364702 14093663 FM 536NP	
				STD. .020 .030 .040 .060			
V6-229 3.8L 3.7360(IN) 94.9(MM) CHEVY ENGINE	1987-94 8.6		3.100" dia. head recess .040" deep w/4 valve reliefs. *Same as 3492 with "COATED SKIRTS". COMP HT: 1.540 PIN DIA: .9273 Offset	3492C	2-5/64, 1-3/16	364702 14094013 14094015	
				STD. .020 .030 .040 .060			
L6-230 3.8L 3.8750(IN) 98.4(MM) CHEVY ENGINE	1963-70 8.3		Flat head w/4 valve reliefs. COMP HT: 1.779 PIN DIA: .9273 Offset	3485	2-5/64, 1-3/16	3792534 3840148 3860407 FM 235NP	
				STD. .020 .030 .040 .060 .080			
V6-231 3.8L 3.8000(IN) 96.52(MM) BUICK ENGINE	1975-87 7.6 8.0 8.5	A	3.050" dia. head recess .215" deep. Non-turbo. COMP HT: 1.805 PIN DIA: .9398 Offset	1731	2-5/64, 1-3/16	1394558 1249538 12157377 25501423 25518053 25527178	
				STD. .020 .030 .040 .060			
V6-231 3.8L 3.8000(IN) 96.5(MM) BUICK ENGINE	1975-87 8.5	A	Hypereutectic. 3.050" dia. head recess .205" deep. Non turbo. Not intended for Racing applications. COMP HT: 1.805 PIN DIA: .9398 Offset	1740H	2-5/64, 1-3/16	1394558 1249538 12157377 25501423 25518053 25527178	
				STD. .020 .030 .040 .060			
V6-231 3.8L 3.8000(IN) 96.52(MM) BUICK ENGINE	1978-87 8.0	7	Hypereutectic. 3.050" dia. head recess .250" deep. Turbo. Not intended for Racing applications. COMP HT: 1.805 PIN DIA: .9398 Offset	1735H	2-5/64, 1-3/16	25502381 25515840 25519444 25528265 FM H521AP	
				STD. .020 .030 .040 .060			
V6-231 3.8L 3.8000(IN) 96.52(MM) BUICK ENGINE	1978-87 8.0	7	Hypereutectic. 3.050" dia. head recess .250" deep. Coated skirts. Turbo COMP HT: 1.805 PIN DIA: .9398 Offset	1735HC	2-5/64 1-3/16	FM H521ACP	
				STD. .020 .030 .040 .060			
V6-231 3.8L 3.8000(IN) 96.52(MM) BUICK ENGINE	1988-93 8.5	C L	Hypereutectic. 3.100" dia. head recess .250" deep. SFI. Not intended for Racing applications. COMP HT: 1.366 PIN DIA: .9054 Offset	1738H	2-1.5mm 1-3.0mm Shallow Groove	25533087 24501072 FM H558P	
				STD. .5mm .75mm 1.0mm 1.5mm			

GENERAL MOTORS

CYL BORE ENGINE	YEAR COMP. RATIO	VIN CODE	NOTES	PART NO. SIZE	RINGS	O.E. ASSY. NO. INTERCHANGE	HEAD SHAPE
V6-231 3.8L 3.8000(IN) 96.52(MM) BUICK ENGINE	1988-93 8.5	C L	Hypereutectic. 3.100" dia. head recess .250" deep. Coated skirts. SFI. COMP HT: 1.366 PIN DIA: .9054 Offset	1738HC STD. .5mm .75mm 1.0mm 1.5mm	2-1.5mm 1-3.0mm Shallow Groove	FM H558CP	
V6-231 3.8L 3.7992(IN) 96.5(MM) BUICK ENGINE	1992-95 8.5	I T 2	Hypereutectic. 3.040" dia. head recess .260" deep. Supercharged. Coated skirts. Floating Pin. COMP HT: 1.388 PIN DIA: .9054 Offset	1750HC STD. .5mm .75mm 1.0mm	1-1.2mm 1-1.5mm 1-3.0mm Shallow Groove	24502091 FM H687CPA	
V6-231 3.8L 3.8000(IN) 96.52(MM) BUICK ENGINE	1993-95 9.0	L	Hypereutectic. 3.100" dia. head recess .295" deep. Not intended for Racing applications. COMP HT: 1.443 PIN DIA: .9054 Offset	1744H STD. .5mm .75mm 1.0mm	1-1.2mm 1-1.5mm 1-3.0mm Shallow Groove	24502953 FM H622P	
V6-231 3.8L 3.7992(IN) 96.5(MM) BUICK ENGINE	1995-01 9.2	K	Hypereutectic. 2.860" dia. head recess .05" deep. Not intended for Racing applications. Floating Pin. COMP HT: 1.090 PIN DIA: .8662 Offset	1745H STD. .5mm .75mm 1.0mm	1-1.2mm 1-1.5mm 1-2.0mm	12537408 FM H840P	
V6-231 3.8L 3.7992(IN) 96.5(MM) BUICK ENGINE	1995-01 9.2	K	Hypereutectic. 2.860" dia. head recess .050" deep. Coated skirts. Floating Pin. COMP HT: 1.090 PIN DIA: .8662 Offset	1745HC STD. .5mm .75mm 1.0mm	1-1.2mm 1-1.5mm 1-2.0mm Shallow Groove	FM H840CP	
V6-232 3.8L 3.7992(IN) 96.5(MM) BUICK ENGINE	1996-04 9.2	1	Hypereutectic. 2.870" dia. head recess .167" deep. *Supercharged. Not intended for Racing applications. Floating Pin. COMP HT: 1.197 PIN DIA: .9054 Offset	1747H STD. .5mm .75mm 1.0mm	1-1.2mm 1-1.5mm 1-2.0mm	12539085 FM H871CT	
V6-232 3.8L 3.7992(IN) 96.5(MM) BUICK ENGINE	1996-04 9.2	1	Hypereutectic. 2.870" dia. head recess .167" deep. *Supercharged. Not intended for Racing applications. Floating Pin. Coated skirts. COMP HT: 1.197 PIN DIA: .9054 Offset	1747HC STD. .5mm .75mm 1.0mm	1-1.2mm 1-1.5mm 1-2.0mm	12539085 FM H871CT	
I6-235 3.9L 3.5625(IN) 90.5(MM) CHEVY ENGINE	1941-62 7.7		Flat head. COMP HT: 2.060 PIN DIA: .8650 Offset	1413 STD. .020 .030 .040 .060 .080	2-3/32, 1-3/16	3693984 3707453 FM 1009P	



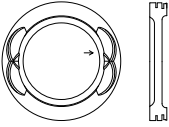
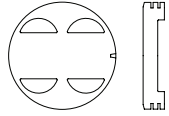
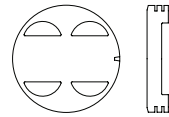
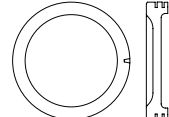
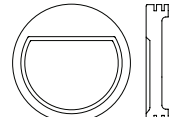
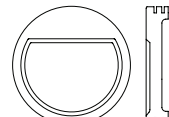
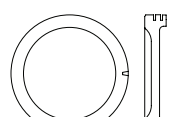
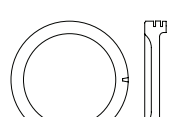

GENERAL MOTORS

CYL BORE ENGINE	YEAR COMP. RATIO	VIN CODE	NOTES	PART NO. SIZE	RINGS	O.E. ASSY. NO. INTERCHANGE	HEAD SHAPE
V6-238 3.9L 3.8976(IN) 99(MM) CHEVY ENGINE	2006-11	C	Hypereutectic, Dish 2.920" dia. .154" deep four valve relief Floating Pin "COATED SKIRTS" Engine Code LZ9 COMP HT: 1.295 PIN DIA: .943 Offset	3531HC STD. .5mm .75mm 1.0mm	1.2mm 1.5mm 2.5mm	89018066	
V8-244 4.0L 3.4250(IN) 86.995(MM) OLDSMOBILE ENGINE	1995 10.3	C	Flat head w/4 valve reliefs. COMP HT: 1.245 PIN DIA: .8660 Offset	3484 STD. .25mm .5mm .75mm 1.0mm	2-1.5mm 1-3.0mm	12552632	
V8-244 4.0L 3.4250(IN) 86.995(MM) OLDSMOBILE ENGINE	1996-99 10.3	C	Flat head w/4 valve reliefs. COMP HT: 1.250 PIN DIA: .8660 Offset	3469 STD. .25mm .5mm .75mm 1.0mm	1-1.2mm 1-1.5mm 1-3.0mm Shallow Groove	12555218	
V8-250 4.1L 3.4646(IN) 88.0(MM) CADILLAC ENGINE	1982-87 8.5	8	2.100" dia. head recess .142" deep. .003 & .005 oversizes available from factory only. COMP HT: 1.630 PIN DIA: .8657 Offset	1820 STD. .003 .005 .010 .020 .030 .040	2-2.0mm 1-4.0mm Shallow Groove	1623538 FM 502P	
L6-250 4.1L 3.8750(IN) 98.4(MM) CHEVY ENGINE	1966-84 8.4		"D" shaped head recess .060" deep. COMP HT: 1.640 PIN DIA: .9273 Offset	1446 STD. .020 .030 .040 .060	2-5/64, 1-3/16	3886040 3886048 6270033 FM 403P	
L6-250 4.1L 3.8750(IN) 98.4(MM) CHEVY ENGINE	1966-84 8.4	P D	"D" shaped head recess .060" deep. *Same as 1446 with "COATED SKIRTS". COMP HT: 1.640 PIN DIA: .9273 Offset	1446C STD. .020 .030 .040 .060	2-5/64, 1-3/16	3886040 3886048 6270033 FM 403CP	
L6-250 4.1L 3.8750(IN) 98.4(MM) CHEVY ENGINE	1966-90 7.6		3.080" dia. head recess .270" deep. Low compression engine. COMP HT: 1.660 PIN DIA: .9273 Offset	3454 STD. .020 .030 .040 .060	2-5/64, 1-3/16	3877610 FM LC291NP	
V6-252 4.1L 3.9650(IN) 100.7(MM) BUICK ENGINE	1980-84 8.0		Hypereutectic. 3.193" dia. head recess .256" deep. Not intended for Racing applications. COMP HT: 1.808 PIN DIA: .9398 Offset	1732H STD. .020 .030 .040 .060	2-5/64, 1-3/16	25505374 FM H471P	

GENERAL MOTORS

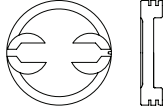
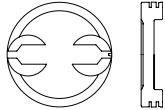
CYL BORE ENGINE	YEAR COMP. RATIO	VIN CODE	NOTES	PART NO. SIZE	RINGS	O.E. ASSY. NO. INTERCHANGE	HEAD SHAPE
V6-252 4.1L 3.9650(IN) 100.7(MM) BUICK ENGINE	1980-84 8.0		Hypereutectic. 3.193" dia. head recess .256" deep. Coated skirts. COMP HT: 1.808 PIN DIA: .9398 Offset	1732HC STD. .020 .030 .040 .060	2-5/64 1-3/16	FM H471CP	
L6-256 4.2L 3.6614(IN) 93.0(MM) GM ENGINE	2002-05 10.1	S	Hypereutectic. 095" high dome. Coated skirts. Floating Pin. COMP HT: 1.101 PIN DIA: .9054 Offset	3496HC STD. .5mm .75mm 1.0mm	1-1.2mm 1-1.5mm 1-2.5mm Shallow Groove	12585784 FM H889CP	
L6-256 4.2L 3.6614(IN) 93.0(MM) GM ENGINE	2006-10 10.1	S	Hypereutectic, Dome 2.216 Dia. .126 High .040 Offset Floating Pin "COATED SKIRTS" COMP HT: 1.108 PIN DIA: .925 Offset	3524HC STD. .25mm .5mm .75mm 1.0mm	1-1.2mm 1-1.5mm 1-2.5mm	89017790 93L70 Casting 12589027	
V8-260 4.3L 3.5000(IN) 88.9(MM) OLDSMOBILE ENGINE	1972-83 8.4		2.350" dia. head recess .165" deep. COMP HT: 1.575 PIN DIA: .9805 Offset	1634 STD. .020 .030 .040 .060	2-5/64 1-3/16	231906 25506654 FM 449P	
L6-261 4.3L 3.750(IN) 95.25(MM) CHEVY ENGINE	1954-62 7.8		Truck engine. Offset pin. COMP HT: 2.029 PIN DIA: .927 Offset	1422 STD. .020 .030 .040 .060	2-3/32 1-3/16	3707460 3835991 CASTING FM 92P	
V6-262 4.3L 4.0000(IN) 101.6(MM) CHEVY ENGINE			Flat head w/4 valve reliefs. COMP HT: 1.540 PIN DIA: .9273 Offset	3487 STD. .020 .030 .040 .060 .080	2-5/64, 1-3/16	3911020 FM 645P	
V6-262 4.3L 4.0000(IN) 101.6(MM) CHEVY ENGINE			Flat head w/4 valve reliefs. *Same as 3487 with "COATED SKIRTS". COMP HT: 1.540 PIN DIA: .9273 Offset	3487C STD. .020 .030 .040 .060 .080	2-5/64, 1-3/16	3911020	
V6-262 4.3L 4.0000(IN) 101.6(MM) CHEVY ENGINE			3.030" head recess .120" deep w/2 valve reliefs. COMP HT: 1.540 PIN DIA: .9273 Center	3488 STD. .020 .030 .040 .060	2-5/64, 1-3/16	3947786	

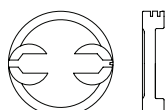
GENERAL MOTORS

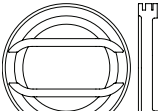
CYL BORE ENGINE	YEAR COMP. RATIO	VIN CODE	NOTES	PART NO. SIZE	RINGS	O.E. ASSY. NO. INTERCHANGE	HEAD SHAPE
V6-262 4.3L 4.0000(IN) 101.6(MM) CHEVY ENGINE	1985-95	W Z	3.160" dia. head recess .08" deep w/4 valve reliefs. Use 1986 & earlier rings.	3445	2-5/64, 1-3/16	14077948 3991488 6271097 10159424 12509282 10049073 14094004 12514101 12520264 FM 640P	
	9.3 8.4	COMP HT: 1.540 PIN DIA: .9273 Offset	STD. .020 .030 .040 .060 .080				
V6-262 4.3L 4.0000(IN) 101.6(MM) CHEVY ENGINE	1985-95	W Z	3.160" dia. head recess .08" deep w/4 valve reliefs. Use 1986 & earlier rings. *Same as 3445 with "COATED SKIRTS".	3445C	2-5/64, 1-3/16	14077948 3991488 6271097 10159424 12509282 10049073 14094004 12514101 12520264 FM H640ACP	
	9.3 8.4	COMP HT: 1.540 PIN DIA: .9273 Offset	STD. .020 .030 .040 .060 .080				
V6-262 4.3L 4.0000(IN) 101.6(MM) CHEVY ENGINE	1985-95		Hypereutectic. 3.300" dia. head recess .185" deep w/2 valve reliefs. Not intended for Racing applications.	3463H	2-5/64, 1-3/16	FM H824P	
		COMP HT: 1.540 PIN DIA: .9273 Offset	STD. .020 .030 .040 .060				
V6-262 4.3L 4.0000(IN) 101.6(MM) CHEVY ENGINE	1985-95		Hypereutectic. 3.300" dia. head recess .185" deep w/2 valve reliefs. Not intended for Racing applications. *Same as 3463H with "COATED SKIRTS".	3463HC	2-5/64, 1-3/16	FM H824CP	
		COMP HT: 1.540 PIN DIA: .9273 Offset	STD. .020 .030 .040 .060				
V6-262 4.3L 4.0000(IN) 101.6(MM) CHEVY ENGINE	1985-95	W Z	Hypereutectic. 3.140" dia. head recess .070" deep w/4 valve reliefs. Use 1986 & earlier rings. Not intended for Racing applications	3490H	2-5/64, 1-3/16	3991488 14077948 6271097 101594241 12509282 10049073 14094004 12514101 12520264	
	8.8 9.4	COMP HT: 1.540 PIN DIA: .9273 Offset	STD. .020 .030 .040 .060				
V6-262 4.3L 4.0000(IN) 101.6(MM) CHEVY ENGINE	1985-95	W Z	Hypereutectic. 3.140" dia. head recess .070" deep w/4 valve reliefs. Use 1986 & earlier rings. *Same as 3490H with "COATED SKIRTS". Not intended for Racing applications	3490HC	2-5/64, 1-3/16	3991488, 6271097 14077448 10159424 10049073 12509282 10049079 10049076 12514101 125420264 FM H640ACP	
	8.8 9.4	COMP HT: 1.540 PIN DIA: .9273 Offset	STD. .020 .030 .040 .060				
V6-262 4.3L 4.0000(IN) 101.6(MM) CHEVY ENGINE	1988-96	W Z	3.250" dia. head recess .125" deep w/2 valve trough reliefs.	3491	2-5/64, 1-3/16	10159430 14093989	
	8.5	COMP HT: 1.540 PIN DIA: .9273 Offset	STD. .020 .030 .040 .060				
V6-262 4.3L 4.0000(IN) 101.6(MM) CHEVY ENGINE	1990-95		Hypereutectic. 3.100" dia. head recess .030" deep w/2 valve trough reliefs. Not intended for Racing applications.	3476H	2-5/64, 1-3/16	FM H695P	
		COMP HT: 1.550 PIN DIA: .9273 Offset	STD. .020 .030 .040 .060				

GENERAL MOTORS

CYL BORE ENGINE	YEAR COMP. RATIO	VIN CODE	NOTES	PART NO. SIZE	RINGS	O.E. ASSY. NO. INTERCHANGE	HEAD SHAPE
V6-262 4.3L 4.0000(IN) 101.6(MM) CHEVY ENGINE	1990-95		Hypereutectic. 3.100" dia. head recess .030" deep w/2 valve trough reliefs. "COATED SKIRTS". Not intended for Racing applications. COMP HT: 1.550 PIN DIA: .9273 Offset	3476HC STD. .020 .030 .040 .060	2-5/64, 1-3/16	FM H695CP	
V6-262 4.3L 4.0000(IN) 101.6(MM) CHEVY ENGINE	1992-96 9.1	W Z	Hypereutectic. 3.100" dia. head recess .080" deep w/4 valve reliefs. Not intended for Racing applications. COMP HT: 1.540 PIN DIA: .9273 Offset	3411H STD. .020 .030 .040 .060	1-2mm, 1-1.5mm, 1-4mm Shallow Groove	14099017 10181389	
V6-262 4.3L 4.0000(IN) 101.6(MM) CHEVY ENGINE	1996-07 9.1	W X	Hypereutectic. 3.100" dia. head recess .080" deep w/4 valve reliefs. Not intended for Racing applications. COMP HT: 1.540 PIN DIA: .9273 Offset	3451H STD. .020 .030 .040 .060	2-1.5mm 1-3.0mm Shallow Groove	12522850 FM H815P FM H699P	
V6-262 4.3L 4.0000(IN) 101.6(MM) CHEVY ENGINE	1996-07 9.1	W X	Hypereutectic. 3.100" dia. head recess .080" deep w/4 valve reliefs. Coated skirts. COMP HT: 1.540 PIN DIA: .9273 Offset	3451HC STD. .020 .030 .040 .060	2-1.5mm 1-3.0mm Shallow Groove		
V8-265 4.3L 3.750(IN) 95.25(MM) CHEVY ENGINE	1955-57 7.8		Flat top 4 valve reliefs. Offset pin. COMP HT: 1.780 PIN DIA: .927 Offset	1410 STD. .020 .030 .040 .060	2-5/64 1-3/16	3734079 3732021 CASTING FM 233P	
V8-265 4.3L 3.7360(IN) 94.9(MM) CHEVY ENGINE	1994-96 9.5	W	Flat head w/4 valve reliefs. COMP HT: 1.540 PIN DIA: .9273 Offset	1482 STD. .020 .030 .040 .060	2-5/64 1-3/16	FM 534NP	
V8-265 4.3L 3.7360(IN) 94.9(MM) CHEVY ENGINE	1994-96 9.5	W	Hypereutectic. Flat head w/4 valve reliefs. Not intended for Racing applications. COMP HT: 1.540 PIN DIA: .9273 Offset	1482H STD. .020 .030 .040 .060	2-5/64, 1-3/16	14044649 14081291 12512898 FM H690P	
V8-265 4.3L 3.7360(IN) 94.9(MM) CHEVY ENGINE	1994-96 9.5	W	Hypereutectic. Flat head w/4 valve reliefs. Coated skirts. COMP HT: 1.540 PIN DIA: .9273 Offset	1482HC STD. .020 .030 .040 .060	2-5/64 1-3/16	FM H690CP	

GENERAL MOTORS

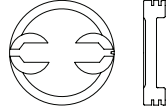
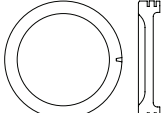
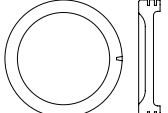
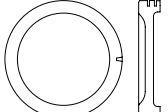
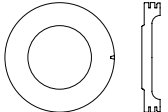
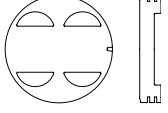
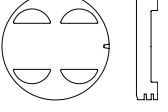
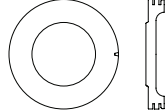
CYL BORE ENGINE	YEAR COMP. RATIO	VIN CODE	NOTES	PART NO. SIZE	RINGS	O.E. ASSY. NO. INTERCHANGE	HEAD SHAPE
V8-265 4.3L 3.7360(IN) 94.9(MM) CHEVY ENGINE	1996-01 9.4	W	3.130" dia. head recess .040" deep. COMP HT: 1.540 PIN DIA: .9273 Offset	3441 STD. .020 .030 .040 .060	2-5/64, 1-3/16 Shallow Groove	12528891 FM 817P	
V8-267 4.4L 3.5000(IN) 88.9(MM) CHEVY ENGINE	1979-82 8.3		2.840" dia. head recess .120" deep. COMP HT: 1.540 PIN DIA: .9273 Offset	3489 STD. .020 .030 .040 .060	2-5/64, 1-3/16	462636 FM 804NP	
V8-273 4.5L 3.6220(IN) 92.0(MM) CADILLAC ENGINE	1987-89 9.0		2.760" dia. head recess .150" deep. COMP HT: 1.640 PIN DIA: .8660 Offset	1823 STD. .25mm .5mm	2-1.5mm 1-3.0mm	1645490 FM 572P	
V8-273 4.5L 3.6220(IN) 92.0(MM) CADILLAC ENGINE	1990-94 9.5		2.940 dia. head recess .020 deep COMP HT: 1.240 PIN DIA: .8662 Offset	1822 STD. .076mm .25mm .5mm	2-1.5mm 1-3.0mm	3521776	
V8-281 4.6L 3.6614(IN) 93.0(MM) CADILLAC ENGINE	1999-05		Hypereutectic. 075" high dome. Coated skirts. Floating Pin. COMP HT: 1.228 PIN DIA: .8265 Offset	3515HC STD. .25mm .5mm .75mm	1-1.2mm 1-1.5mm 1-2.5mm Shallow Groove		
V8-281 4.6L 3.6614(IN) 93.0(MM) CADILLAC ENGINE	1993-03 10.3	Y 9	Hypereutectic. Flat head w/4 valve reliefs. Not intended for Racing applications. Floating Pin. COMP HT: 1.240 PIN DIA: .8660 Offset	1826H STD. .25mm .5mm .75mm 1.0mm	2-1.5mm 1-3.0mm Shallow Groove	12553806	
V8-281 4.6L 3.6614(IN) 93.0(MM) CADILLAC ENGINE	1993-96 10.3	Y 9	Hypereutectic. Flat head w/4 valve reliefs. Coated skirts. Floating Pin. COMP HT: 1.240 PIN DIA: .8660 Offset	1826HC STD. .25mm .5mm .75mm 1.0mm	2-1.5mm 1-3.0mm Shallow Groove	FM H873CP	
V8-281 4.6L 3.6614(IN) 93.0(MM) CADILLAC ENGINE	2003-05 10.5	Y	Hypereutectic. 075" high dome. Coated skirts. Floating Pin. COMP HT: 1.228 PIN DIA: .9054 Offset	3497HC STD. .25mm .5mm .75mm 1.0mm	1-1.2mm 1-1.5mm 1-2.5mm Shallow Groove	89017429	

GENERAL MOTORS

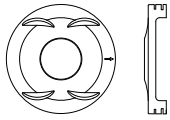
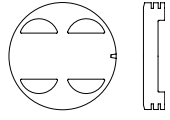
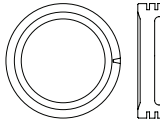
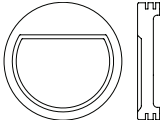
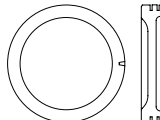
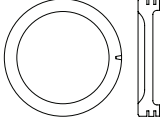
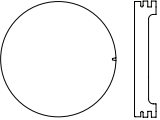
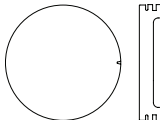
CYL BORE ENGINE	YEAR COMP. RATIO	VIN CODE	NOTES	PART NO. SIZE	RINGS	O.E. ASSY. NO. INTERCHANGE	HEAD SHAPE
V8-281 4.6L 3.6614(IN) 93.0(MM) CADILLAC ENGINE	2006- Present	A	Hypereutectic .126 tall dome Four valve relief Floating Pin "COATED SKIRTS" Cadillac STS - STX COMP HT: 1.232 PIN DIA: .905 Offset	3532HC STD. .25mm .5mm .75mm	1.2mm 1.5mm 2.5mm	89017430 81045C	
V8-283 4.6L 3.8750(IN) 98.4(MM) CHEVY ENGINE	1957-70 8.3		Flat head w/4 valve reliefs. COMP HT: 1.779 PIN DIA: .9273 Offset	1412 STD. .020 .030 .040 .060 .080	2-5/64, 1-3/16	3739886 3840148 3860407 FM 235NP	
L6-292 4.8L 3.8750(IN) 98.4(MM) CHEVY ENGINE	1963-84 7.2		3.110" dia. Head recess .230" deep. Truck engine. Low compression engine. COMP HT: 1.935 PIN DIA: .9273 Center	1437 STD. .020 .030 .040 .060	2-3/32, 1-3/16		
L6-292 4.8L 3.8750(IN) 98.4(MM) CHEVY ENGINE	1963-89 8.0		"D" shaped head recess .300" deep. Truck engine. COMP HT: 2.009 PIN DIA: .9273 Center	1429 STD. .020 .030 .040 .060	2-3/32, 1-3/16	3794494	
L6-292 4.8L 3.8750(IN) 98.4(MM) CHEVY ENGINE	1963-89 7.6		Hypereutectic. 3.200" dia. head recess .312" deep. Not intended for Racing applications COMP HT: 2.010 PIN DIA: .9273 Center	3468H STD. .020 .030 .040 .060	2-3/32, 1-3/16	FM H909P	
L6-292 4.8L 3.8750(IN) 98.4(MM) CHEVY ENGINE	1963-89 7.6		Hypereutectic. 3.200" dia. head recess .312" deep. *Same as 3468H with "COATED SKIRTS". Not intended for Racing applications COMP HT: 2.010 PIN DIA: .9273 Center	3468HC STD. .020 .030 .040 .060	2-3/32, 1-3/16	FM H909CP	
V8-293 4.8L 3.7799(IN) 96.01(MM) CHEVY ENGINE	1999-03 9.45	V	Hypereutectic. Flat head. Truck engine. "COATED SKIRTS". COMP HT: 1.324 PIN DIA: .9452 Offset	3482HC STD. .5mm .75mm 1.0mm	2-1.5mm 1-3.0mm Shallow Groove	88894404 FM H855CP	
V8-293 4.8L 3.7800(IN) 96.06(MM) CHEVY ENGINE	1999-06 2005-09 9.45	V C K	Hypereutectic. Flat Top "COATED SKIRTS". Floating Pin. COMP HT: 1.323 PIN DIA: .9429	3520HC STD. .5mm .75mm 1.0mm	2-1.5mm 1-3.0mm Shallow Groove	89017577 FM H1132CT	

GENERAL MOTORS

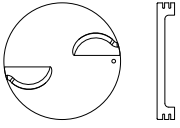
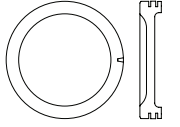
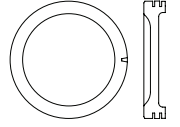
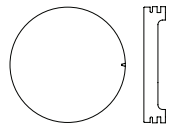
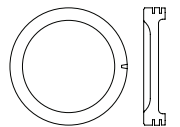
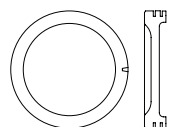
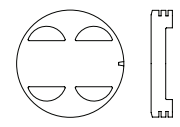
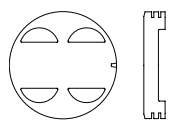
CYL BORE ENGINE	YEAR COMP. RATIO	VIN CODE	NOTES	PART NO. SIZE	RINGS	O.E. ASSY. NO. INTERCHANGE	HEAD SHAPE
V8-292 4.8L 3.7795(IN) 96(MM) CHEVY ENGINE	2010-14	A	Hypereutectic with Anodized Head and Top Ring Groove Flat Top with two valve reliefs Floating Pin "COATED SKIRTS" COMP HT: 1.328 PIN DIA: .943	3526HCA STD. .5mm .75mm 1.0mm	1.5mm 1.5mm 3.0mm	19208675	
V8-298 4.9L 3.6220(IN) 92.0(MM) CADILLAC ENGINE	1991-94 9.5		2.940 dia. head recess .020 deep. Non-turbo. COMP HT: 1.240 PIN DIA: .8662 Offset	1822 STD. .076mm .25mm .5mm	2-1.5mm 1-3.0mm	3521776	
V8-300 4.9L 3.7500(IN) 95.25(MM) BUICK ENGINE	1964-67 8.3		3.060" dia. head recess .230" deep. COMP HT: 1.835 PIN DIA: .9398 Offset	1724 STD. .020 .030 .040 .060	2-5/64, 1-3/16	1399524 FM 279P	
V8-301 4.9L 4.0000(IN) 101.6(MM) PONTIAC ENGINE	1977-81 8.0	W	Flat head. COMP HT: 1.570 PIN DIA: .9273 Offset	1527 STD. .020 .030 .040 .060	2-5/64 1-3/16	547147 10005635 10010447 1114P FM 457P	
V8-301 4.9L 4.0000(IN) 101.6(MM) PONTIAC ENGINE	1980-81 7.5		LU8 turbocharged engine. Full circular dish .112 deep. COMP HT: 1.570 PIN DIA: .9273 Offset	1531 STD. .020 .030 .040 .060	2-5/64 1-3/16 Shallow Groove	10013653/59	
V8-305 5.0L 3.7360(IN) 94.9(MM) CHEVY ENGINE	1976-86 8.4		3.160" dia. head recess .090" deep. COMP HT: 1.540 PIN DIA: .9273 Offset	1449 STD. .020 .030 .040 .060	2-5/64, 1-3/16	364702 14019883 FM 454NP	
V8-305 5.0L 3.7360(IN) 94.9(MM) CHEVY ENGINE	1982-86 9.5		Flat head w/4 valve reliefs. COMP HT: 1.540 PIN DIA: .9273 Offset	1482 STD. .020 .030 .040 .060	2-5/64 1-3/16	FM 534NP	
V8-305 5.0L 3.7360(IN) 94.9(MM) CHEVY ENGINE	1982-86 9.5		Hypereutectic. Flat head w/4 valve reliefs. Not intended for Racing applications. COMP HT: 1.540 PIN DIA: .9273 Offset	1482H STD. .020 .030 .040 .060	2-5/64, 1-3/16	14044649 14081291 FM H534P	

GENERAL MOTORS

CYL BORE ENGINE	YEAR COMP. RATIO	VIN CODE	NOTES	PART NO. SIZE	RINGS	O.E. ASSY. NO. INTERCHANGE	HEAD SHAPE
V8-305 5.0L 3.7360(IN) 94.9(MM) CHEVY ENGINE	1982-86 9.5		Hypereutectic. Flat head w/4 valve reliefs. Coated skirts. COMP HT: 1.540 PIN DIA: .9273 Offset	1482HC STD. .020 .030 .040 .060	2-5/64 1-3/16	FM H690CP	
V8-305 5.0L 3.7360(IN) 94.9(MM) CHEVY ENGINE	1987-95 8.4 8.6 9.3	H	3.100" dia. head recess .040" deep w/4 valve reliefs. COMP HT: 1.540 PIN DIA: .9273 Offset	1493 STD. .020 .030 .040 .060	2-5/64, 1-3/16	364702 14094013 14094015 FM 536NP	
V8-305 5.0L 3.7360(IN) 94.9(MM) CHEVY ENGINE	1987-95 8.4 8.6 9.3	H	3.100" dia. head recess .040" deep w/4 valve reliefs. *Same as 1493 with "COATED SKIRTS". COMP HT: 1.540 PIN DIA: .9273 Offset	1493C STD. .020 .030 .040 .060	2-5/64, 1-3/16	364702 14094013 14094015 FM 536NCP	
V8-305 5.0L 3.7360(IN) 94.9(MM) CHEVY ENGINE	1996-01 9.4	M W	3.130" dia. head recess .040" deep. COMP HT: 1.540 PIN DIA: .9273 Offset	3441 STD. .020 .030 .040 .060	2-5/64, 1-3/16 Shallow Groove	12528891 FM 817P	
V8-305 5.0L 3.7360(IN) 94.9(MM) GM ENGINE			305 engine using a 350 crank. Not O.E. weight. 3.125" dia. head recess .095" deep w/4 valve reliefs. COMP HT: 1.540 PIN DIA: .9273 Offset	3513 STD. .020 .030 .040 .060	2-5/64 1-3/16	FM 611P	
V8-305 5.0L 3.7360(IN) 94.9(MM) GM ENGINE			305 engine using a 350 crank. Not O.E. weight. 2.520" dia. head recess .065" deep w/4 valve reliefs. COMP HT: 1.540 PIN DIA: .9273 Offset	3514 STD. .020 .030 .040 .060	2-5/64 1-3/16	FM 627NP	
V8-307 5.0L 3.8750(IN) 98.4(MM) CHEVY ENGINE	1968-73 8.7		Flat head w/4 valve reliefs. COMP HT: 1.655 PIN DIA: .9273 Offset	1438 STD. .020 .030 .040 .060	2-5/64, 1-3/16	3927120 3923294 6271087 FM 295AP	
V8-307 5.0L 3.8000(IN) 96.52(MM) OLDSMOBILE ENGINE	1980-84 7.9		2.700" dia. head recess .110" deep. Floating Pin. COMP HT: 1.595 PIN DIA: .9805 Offset	1636 STD. .020 .030 .040 .060	2-5/64 1-3/16	22506658 FM 472P	

3535HC - 5.3L 1999-03. Same as 3472HC but with floating .945 pin.

GENERAL MOTORS

CYL BORE ENGINE	YEAR COMP. RATIO	VIN CODE	NOTES	PART NO. SIZE	RINGS	O.E. ASSY. NO. INTERCHANGE	HEAD SHAPE
V8-307 5.0L 3.8000(IN) 96.5(MM) OLDSMOBILE ENGINE	1985-90 8.0		Recessed head .270" deep. COMP HT: 1.605 PIN DIA: .9805 Offset	1639 STD. .020 .030 .040 .060	2-5/64 1-3/16	22527480R 22527479L	
V8-307 5.0L 3.8000(IN) 96.5(MM) OLDSMOBILE ENGINE	1985-90 8.0		Hypereutectic. Recessed head .270" deep. "COATED SKIRTS". Not intended for Racing applications COMP HT: 1.605 PIN DIA: .9805 Offset	1639HC STD. .020 .030 .040 .060	2-5/64 1-3/16	22527480R 22527479L FM H801CP	
V8-325 5.3L 3.7800(IN) 96.01(MM) CHEVY ENGINE	1999-03 9.45	T	Hypereutectic. 3.050" dia. head recess .068" deep. Truck engine. "COATED SKIRTS". Not intended for Racing applications. COMP HT: 1.328 PIN DIA: .9451 Offset	3472HC STD. .5mm .75mm 1.0mm	2-1.5mm 1-3.0mm Shallow Groove	88894397 FM H856CP	
NEW V8-327 5.3L 3.780 96.01(MM) GM ENGINE	1999-03 9.45	T	Same as 3472HC but with floating pin. DO NOT use with press pin rods. Floating rod only. Hypereutectic. 3.050" dia. head recess .068" deep. Truck engine "COATED SKIRTS" Not intended for racing applications COMP HT: 1.328 PIN DIA: .945 Offset	3535HC STD. .50mm .75mm 1.0mm	1-1.5mm 1-1.5mm 1-3.0mm Shallow Oil Groove		
V8-325 5.3L 3.7800(IN) 96.01(MM) CHEVY ENGINE	2004-07 9.45	P T Z	Hypereutectic. 3.100" dia. head recess .068" deep cup LM7, L59, LM4 "COATED SKIRTS". Floating Pin. Not intended for racing applications. COMP HT: 1.323 PIN DIA: .9429	3519HC STD. .25mm .5mm .75mm 1.0mm	2-1.5mm 1-3.0mm Shallow Groove	89017579 FM H1127CT	
V8-325 5.3L 3.7800(IN) 96.01(MM) CHEVY ENGINE	2005-09 9.45 9.9	B M J O 3 C	Hypereutectic. Flat Top. High Output "Flex Fuel" "COATED SKIRTS". Floating Pin. LS4, LM4, L33, LH8, LH6, LMG, LY5 Not intended for racing applications. COMP HT: 1.323 PIN DIA: .9429	3520HC STD. .25mm .5mm .75mm 1.0mm	2-1.5mm 1-3.0mm Shallow Groove	89017577 FM H1132CP	
V8-325 5.3L 3.7795(IN) 96.0(MM) CHEVY ENGINE	2010-14 9.45	0 3 4 P 7 J M	Hypereutectic with ANODIZED CROWN AND TOP RING GROOVE flat top with two valve reliefs Floating Pin "COATED SKIRTS" COMP HT: 1.328 PIN DIA: .943 Offset	3526HCA STD. .5mm .75mm 1.0mm	1.5mm 1.5mm 3.0mm	19208675 FMA 24A	
V8-327 5.4L 4.0000(IN) 101.6(MM) CHEVY ENGINE	1962-68 8.0		3.150" dia. head recess .065" deep w/2 valve reliefs. COMP HT: 1.655 PIN DIA: .9273 Center	3413 STD. .020 .030 .040 .060	2-5/64, 1-3/16	3816974	

GENERAL MOTORS

CYL BORE ENGINE	YEAR COMP. RATIO	VIN CODE	NOTES	PART NO. SIZE	RINGS	O.E. ASSY. NO. INTERCHANGE	HEAD SHAPE
V8-327 5.4L 4.0000(IN) 101.6(MM) CHEVY ENGINE	1962-69 8.7		Flat head w/4 valve reliefs. COMP HT: 1.654 PIN DIA: .9273 Offset	1423 STD. .020 .030 .040 .060 .080	2-5/64, 1-3/16	3799491 FM 310NP	
V8-340 5.6L 3.7500(IN) 95.25(MM) BUICK ENGINE	1966-67 8.4		3.060" dia. head recess .230" deep. COMP HT: 1.835 PIN DIA: .9398 Offset	1724 STD. .020 .030 .040 .060	2-5/64, 1-3/16	1395184 FM 279P	
V8-346 5.7L 3.8976(IN) 99.0(MM) GM ENGINE	1997-04 10.0	G S	Hypereutectic. LS1 engine. Flat head. Coated skirts. Press Pin. COMP HT: 1.330 PIN DIA: .9449 Offset	3498HC STD. .25mm .5mm .75mm 1.0mm	2-1.5mm 1-3.0mm	88984245 FM H868CP	
V8-346 5.7L 3.8976(IN) 99.0(MM) GM ENGINE	2004-06 10.5	S	Hypereutectic. LS6 engine. Flat head. Coated skirts. Floating Pin. COMP HT: 1.330 PIN DIA: .9430 Offset	3499HC STD. .25mm .5mm .75mm 1.0mm	2-1.5mm 1-3.0mm	89017581	
V8-350 5.7L 3.8000(IN) 96.52(MM) BUICK ENGINE	1968-81 8.1 9.0 10.25 8.5 8.0		3.050" dia. head recess .215" deep. COMP HT: 1.805 PIN DIA: .9398 Offset	1746 STD. .020 .030 .040 .060	2-5/64, 1-3/16	1249538 FM 657P	
V8-350 5.7L 3.8000(IN) 96.5(MM) BUICK ENGINE	1968-81 8.5		Hypereutectic. 3.050" dia. head recess .205" deep. Not intended for Racing applications. COMP HT: 1.805 PIN DIA: .9398 Offset	1749H STD. .020 .030 .040 .060	2-5/64, 1-3/16	1249538 1394558 25501423 1394208 25527178 450 NP	
V8-350 5.7L 4.0000(IN) 101.6(MM) CHEVY ENGINE	1969-70 8.8		Flat head w/4 valve reliefs. Truck & Passenger. COMP HT: 1.540 PIN DIA: .9273 Offset	1436 STD. .020 .030 .040 .060 .080	2-5/64, 1-3/16	3911020 FM 345NP	
V8-350 5.7L 4.0000(IN) 101.6(MM) CHEVY ENGINE	1969-70 8.8		Flat head w/4 valve reliefs. Truck & Passenger. *Same as 1436 with "COATED SKIRTS". COMP HT: 1.540 PIN DIA: .9273 Offset	1436C STD. .020 .030 .040 .060 .080	2-5/64, 1-3/16	3911020	

3536HC - 350 10:1 Flat Top. Floating Pin. 1.5mm 1.5mm 3.0mm Rings

GENERAL MOTORS

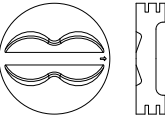
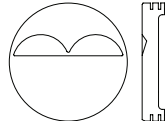
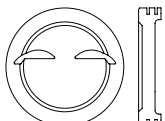
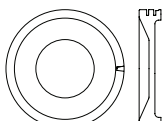
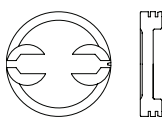
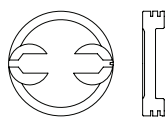
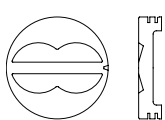
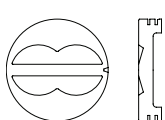
CYL BORE ENGINE	YEAR COMP. RATIO	VIN CODE	NOTES	PART NO. SIZE	RINGS	O.E. ASSY. NO. INTERCHANGE	HEAD SHAPE
V8-350 5.7L 4.000 101.6(MM) CHEVY ENGINE	HI PERF		Hypereutectic. MACHINED 6.8CC VALVE POCKETS 2.120" X .225" DEEP 5.7" Press or Floating rod. "Coated Skirts" 10:1 with 64cc head. COMP HT: 1.560 PIN DIA: .927 Offset	3536HC STD. .020 .030 .040 .060	1-1.5mm 1-1.5mm 1-3.0mm		
V8-350 5.7L 4.0000(IN) 101.6(MM) CHEVY ENGINE	1969-78 9.0		Flat head w/2 valve reliefs. Truck engine. COMP HT: 1.540 PIN DIA: .9273 Center	1442 STD. .020 .030 .040 .060	2-5/64, 1-3/16	3947746 FM 399P	
V8-350 5.7L 4.0000(IN) 101.6(MM) CHEVY ENGINE	1969-83 8.0		3.030" head recess .120" deep w/2 valve reliefs. Truck engine. COMP HT: 1.540 PIN DIA: .9273 Center	1441 STD. .020 .030 .040 .060	2-5/64, 1-3/16	3947786 FM 398P	
V8-350 5.7L 4.0000(IN) 101.6(MM) CHEVY ENGINE	1969-90 8.4		For use with 305 heads. 3.300" dia. head recess .270" deep. COMP HT: 1.540 PIN DIA: .9273 Offset	1472 STD. .020 .030 .040 .060 .080	2-5/64, 1-3/16		
V8-350 5.7L 4.0000(IN) 101.6(MM) CHEVY ENGINE	1969-90 8.5 9.0 9.5 10.0		Hypereutectic. 3.140" dia. head recess .070" deep w/4 valve reliefs. Use 1986 & earlier rings. Not intended for Racing applications COMP HT: 1.540 PIN DIA: .9273 Offset	1476H STD. .020 .030 .040 .060	2-5/64, 1-3/16	3991488, 6271097 14077448 10159424 10049073 12509282 10049079 10049076 12514101 125420264 FM H423NP	
V8-350 5.7L 4.0000(IN) 101.6(MM) CHEVY ENGINE	1969-90 8.5 9.0 9.5 10.0		Hypereutectic. 3.140" dia. head recess .070" deep w/4 valve reliefs. Use 1986 & earlier rings. *Same as 1476H with "COATED SKIRTS". Not intended for Racing applications COMP HT: 1.540 PIN DIA: .9273 Offset	1476HC STD. .020 .030 .040 .060	2-5/64, 1-3/16	3991488, 6271097 14077448 10159424 10049073 12509282 10049079 10049076 12514101 125420264 FM H423NCP	
V8-350 5.7L 4.0000(IN) 101.6(MM) CHEVY ENGINE	1969-90 9.0 10.3 11.1		Hypereutectic. Flat head w/4 valve reliefs. Not intended for Racing applications. COMP HT: 1.540 PIN DIA: .9273 Offset	1479H STD. .020 .030 .040 .060	2-5/64, 1-3/16	3911020	
V8-350 5.7L 4.0000(IN) 101.6(MM) CHEVY ENGINE	1969-90		Hypereutectic. Flat head w/4 valve reliefs. *Not De-Stroke*. Not intended for Racing applications. COMP HT: 1.560 PIN DIA: .9273 Offset	3437H STD. .020 .030 .040 .060	2-5/64 1-3/16	3911020	

GENERAL MOTORS

CYL BORE ENGINE	YEAR COMP. RATIO	VIN CODE	NOTES	PART NO. SIZE	RINGS	O.E. ASSY. NO. INTERCHANGE	HEAD SHAPE
V8-350 5.7L 4.0000(IN) 101.6(MM) CHEVY ENGINE	1969-90		Hypereutectic. Flat head w/4 valve reliefs. *Not De-Stroke*. *Same as 3437H with "COATED SKIRTS". Not intended for Racing applications. COMP HT: 1.560 PIN DIA: .9273 Offset	3437HC STD. .020 .030 .040 .060	2-5/64 1-3/16	3911020 FM H345ACP	
V8-350 5.7L 4.0000(IN) 101.6(MM) CHEVY ENGINE	1971-95 7.9		3.160" dia. head recess .080" deep w/4 valve reliefs. Use 1986 & earlier rings. COMP HT: 1.540 PIN DIA: .9273 Offset	1470 STD. .020 .030 .040 .060 .080	2-5/64, 1-3/16	3991488, 6271097 14077448, 10159424 10049073, 12509282 10049076 10049079 14094004 12514101 12520264 FM 423NP	
V8-350 5.7L 4.0000(IN) 101.6(MM) CHEVY ENGINE	1972-96		Hypereutectic. 3.300" dia. head recess .185" deep w/2 valve reliefs. Not intended for Racing applications. COMP HT: 1.540 PIN DIA: .9273 Offset	3462H STD. .020 .030 .040 .060 .080	2-5/64, 1-3/16 Shallow Groove	FM H580P	
V8-350 5.7L 4.0000(IN) 101.6(MM) CHEVY ENGINE	1972-96		Hypereutectic. 3.300" dia. head recess .185" deep w/2 valve reliefs. Not intended for Racing applications. *Same as 3462H with "COATED SKIRTS". COMP HT: 1.540 PIN DIA: .9273 Offset	3462HC STD. .020 .030 .040 .060 .080	2-5/64, 1-3/16 Shallow Groove	FM H580CP	
V8-350 5.7L 4.0000(IN) 101.6(MM) CHEVY ENGINE	1986-96 8.5	K	3.250" dia. head recess .125" deep w/2 valve trough reliefs. COMP HT: 1.540 PIN DIA: .9273 Offset	1487 STD. .020 .030 .040 .060	2-5/64, 1-3/16	14093989 10159430	
V8-350 5.7L 4.0000(IN) 101.6(MM) CHEVY ENGINE	1990-97 9.5 10.25	P	Hypereutectic. Flat head w/4 valve reliefs. Corvette LTI. Not intended for Racing applications. COMP HT: 1.540 PIN DIA: .9273 Offset	1489H STD. .020 .030 .040 .060	1-2.0mm 1-1.5mm 1-4.0mm	10159436 10128452 12521445	
V8-350 5.7L 4.0000(IN) 101.6(MM) CHEVY ENGINE	1990-97 9.5 10.25	P	Hypereutectic. Flat head w/4 valve reliefs. Corvette LTI. Coated skirts. COMP HT: 1.540 PIN DIA: .9273 Offset	1489HC STD. .020 .030 .040 .060	1-2.0mm 1-1.5mm 1-4.0mm	FM H597ACP	
V8-350 5.7L 4.0000(IN) 101.6(MM) CHEVY ENGINE	1992-96		Hypereutectic. 3.100" dia. head recess .080" deep w/4 valve reliefs. Not intended for Racing applications. COMP HT: 1.540 PIN DIA: .9273 Offset	3471H STD. .020 .030 .040 .060	2mm 1.5mm 4mm Shallow Groove	14099025	

GENERAL MOTORS

CYL BORE ENGINE	YEAR COMP. RATIO	VIN CODE	NOTES	PART NO. SIZE	RINGS	O.E. ASSY. NO. INTERCHANGE	HEAD SHAPE
V8-350 5.7L 4.0000(IN) 101.6(MM) CHEVY ENGINE	1996-01 9.4	K R	Hypereutectic. 3.100" dia. head recess .080" deep w/4 valve reliefs. Not intended for Racing applications. COMP HT: 1.540 PIN DIA: .9273 Offset	3470H	2-1.5mm 1-3.0mm Shallow Groove	12522850	
				STD. .020 .030 .040 .060			
V8-350 5.7L 4.0000(IN) 101.6(MM) CHEVY ENGINE	1996-01 9.4	K R	Hypereutectic. 3.100" dia. head recess .080" deep w/4 valve reliefs. SAME AS 3470H WITH "COATED SKIRTS". Not intended for Racing applications. COMP HT: 1.540 PIN DIA: .9273 Offset	3470HC	2-1.5mm 1-3.0mm Shallow Groove	12522850 FM H815ACP	
				STD. .020 .030 .040 .060			
V8-350 5.7L 4.0570(IN) 103.0(MM) OLDSMOBILE ENGINE	1968-80 8.4	R	2.920" dia. head recess .220" deep. COMP HT: 1.595 PIN DIA: .9805 Offset	1633	2-5/64 1-3/16	400591 231101 231433 25506662 FM 332AP	
				STD. .020 .030 .040 .060			
V8-350 Diesel 5.7L 4.057(IN) 103.04(MM) OLDSMOBILE ENGINE	1978-85 22.5:1		DIESEL Flat Top with two valve reliefs Iron insert in top ring groove Floating Pin Right and left pistons COMP HT: 1.770 PIN DIA: 1.095 Offset	1637D	5/64 5/64 3/16	22520324LH 22520325RH	
				STD. .020 .030 .040			
V8-350 5.7L 3.8750(IN) 98.4(MM) PONTIAC ENGINE	1968-77 7.8	P	Flat head w/4 valve reliefs. COMP HT: 1.700 PIN DIA: .9805 Offset	1520	2-5/64 1-3/16	9792415 9794465 478809 493165 499054 FM 357P	
				STD. .020 .030 .040 .060			
V8-364 6.0L 4.0000(IN) 101.6(MM) CHEVY ENGINE	1999-03 9.45	U	Hypereutectic. 3.050" dia. head recess .050" deep. Truck engine. "COATED SKIRTS". Not intended for Racing applications. COMP HT: 1.328 PIN DIA: .9451 Offset	3473HC	2-1.5mm 1-3.0mm Shallow Groove	88894008 FM H857CP	
				STD. .5mm .75mm 1.0mm 1.5mm			
V8-364 6.0L 4.0000(IN) 101.6(MM) CHEVY ENGINE	2003-08 9.45	U	Hypereutectic. 2.780" dia. head recess .058" deep cup, LQ4, LYC, L76 GMC Truck, Hummer H2 Engine "COATED SKIRTS". Floating Pin. Not intended for racing applications. COMP HT: 1.328 PIN DIA: .9429	3516HC	2-1.5mm 1-3.0mm Shallow Groove	89017473 FM H1128CT	
				STD. .25mm .5mm .75mm 1.0mm			
V8-364 6.0L 4.0000(IN) 101.6(MM) CHEVY ENGINE	2002-08 10.0 10.9	N U	Hypereutectic. Flat Top LQ9, LS2 Escalade, Corvette, GTO, SSR, CTS-V "COATED SKIRTS". Floating Pin. Not intended for racing applications. COMP HT: 1.328 PIN DIA: .9429	3517HC	2-1.5mm 1-3.0mm Shallow Groove	FM H1129CT	
				STD. .10mm .25mm .5mm .75mm 1.0mm			

GENERAL MOTORS

CYL BORE ENGINE	YEAR COMP. RATIO	VIN CODE	NOTES	PART NO. SIZE	RINGS	O.E. ASSY. NO. INTERCHANGE	HEAD SHAPE
V8-364 6.0L 4.0000(IN) 101.6(MM) CHEVY ENGINE	2006-08 9.45		Hypereutectic. 3.100" dia. head recess .047 deep cup, two valve reliefs Variable Valve timing. "COATED SKIRTS". Floating Pin. Not intended for racing applications. COMP HT: 1.328 PIN DIA: .9429	3518HC STD. .25mm .5mm .75mm 1.0mm	2-1.5mm 1-3.0mm Shallow Groove	89017850	
V8-364 6.0L 4.0000(IN) 101.6(MM) CHEVY ENGINE	2005-11 H 2 Y		Hypereutectic with ANODIZED CROWN AND TOP RING GROOVE flat top with no valve reliefs Floating Pin "COATED SKIRTS" COMP HT: 1.328 PIN DIA: .943 Offset	3527HCA STD. .25mm .5mm .75mm 1.0mm	1.2mm 1.5mm 2.5mm	19178305 81077C FM H1506CPA	
V8-366 6.0L 3.9370(IN) 100.0(MM) CHEVY ENGINE	1966-85 8.0		Flat head w/1 valve relief. Truck engine. COMP HT: 2.160 PIN DIA: .9898 Center	1435D STD. .020 .030 .040 .060	1-3/32, 2-5/64, 1-3/16 Iron Top Groove	3886172 10106498 FM H958CP	
V8-366 6.0L 3.9375(IN) 100.0(MM) CHEVY ENGINE	1966-85 7.6		Hypereutectic. Flat head piston w/2 valve reliefs. Truck engine. "COATED SKIRTS". COMP HT: 2.100 PIN DIA: .9898 Center	3481HC STD. .020 .030 .040 .060	1-3/32, 2-5/64, 1-3/16	FM H719CP	
V8-366 6.0L 3.9375(IN) 100.0(MM) CHEVY ENGINE	1985-90 8.0 Sm. Chmbr. 9.0		Dome head .095" high w/1 valve relief. Propane engine and 1985-90 gas truck engine. Except H5D. COMP HT: 2.160 PIN DIA: .9898 Center	1490D STD. .020 .030 .040 .060	1-3/32 2-5/64 1-3/16 Iron Top Groove	10106480 10046482 10108926 14100826	
V8-366 6.0L 3.9380(IN) 100.0(MM) CHEVY ENGINE	1985-90 8.0		Hypereutectic. Dome head .098" w/1 valve relief. Truck engine w/H5D Emissions. "COATED SKIRTS" COMP HT: 2.135 PIN DIA: .9898 Center	3461HC STD. .020 .030 .040 .060	1-3/32, 2-5/64, 1-3/16	FM H721CP	
V8-366 6.0L 3.9380(IN) 100.0(MM) CHEVY ENGINE	1991-93 8.0		Hypereutectic. Dome head .095" w/1 valve relief. Truck engine. Except H5D. COMP HT: 2.160 PIN DIA: .9898 Center	3410H STD. .020 .030 .040 .060	1-3/32 2-5/64 1-3/16 Shallow Groove	10126748 H 811CP	
V8-366 6.0L 3.9375(IN) 100.0(MM) CHEVY ENGINE	1991-93 8.0		Dome head .095" w/1 valve relief. Truck engine. Except H5D. Use early style rings. COMP HT: 2.160 PIN DIA: .9898 Center	3448D STD. .020 .030 .040 .060	1-3/32 2-5/64 1-3/16 Iron Top Groove	FM H811CP	

GENERAL MOTORS

CYL BORE ENGINE	YEAR COMP. RATIO	VIN CODE	NOTES	PART NO. SIZE	RINGS	O.E. ASSY. NO. INTERCHANGE	HEAD SHAPE
V8-366 6.0L 3.9375(IN) 100.0(MM) CHEVY ENGINE	1991-98		Hypereutectic. Dome head .110" w/1 valve relief. "COATED SKIRTS". Truck engine. COMP HT: 2.125 PIN DIA: .9898 Center	3479HC STD. .020 .030 .040 .060	1-3/32 2-5/64 1-3/16 Shallow Groove	FM H811CP	
V8-378 6.2L 4.065(IN) 103.25(MM) CHEVY ENGINE	2008-10 10.7	W	Hypereutectic. Flat top. "COATED SKIRTS". Floating pin. Offset pin. LS3 Engine. Not intended for racing applications. COMP HT: 1.330 PIN DIA: .9430 Offset	3523HC STD. .38mm .5mm .75mm 1.0mm	2-1.5mm 1-2.5mm	19207287	
V8-378 6.2L 4.065(IN) 103.25(MM) CHEVY ENGINE	2008-09	2	Hypereutectic with ANODIZED CROWN AND TOP RING GROOVE flat top with two valve reliefs Floating Pin "COATED SKIRTS" COMP HT: 1.328 PIN DIA: .943 Offset	3530HCA STD. .10mm .25mm .5mm .75mm	1.5mm 1.5mm 2.5mm	19178597 810968	
V8-379 6.2L 3.9764(IN) 101.0(MM) CHEVY ENGINE	1982-93 20.1		Diesel engine. Flat head w/Ricardo Cup. Keystone top groove. Min. clearance cylinders 1-6 (.0045") and cylinders 7 and 8 (.0055"). See note on page 104. COMP HT: 2.119 PIN DIA: 1.220 Center	1467D STD. .5mm .75mm 1.0mm 1.5mm	Keystone 1-2.0mm 1-4.0mm Iron Top Groove	14053377 23500391 23500393 FM H587P	
V8-389 6.4L 4.0625(IN) 103.188MM) GM PONTIAC ENGINE	1959-66		Flat Top 4 Valve Reliefs .060 Offset Pin COMP HT: 1.700 PIN DIA: .980 Offset	1516 STD. .020 .030 .040 .060	2-5/64 1-3/16	FM 288P	
V8-395 6.5L 4.0551(IN) 103.0(MM) CHEVY ENGINE	1992-01		Diesel Turbo and Non-Turbo. Flat head w/Ricardo Cup .055" deep. Hard-Anodized head. COMP HT: 2.115 PIN DIA: 1.2205 Center	3436D STD. .5mm .75mm 1.0mm 1.5mm	Keystone 1-2.0mm 1-4.0mm Iron Top Groove	10183937 12550059 12550061 10236521 FM 2773PNA	
V8-396 6.5L 4.0938(IN) 104.0(MM) CHEVY ENGINE	1965-69 9.6 w/96.4cc		.188" high crown. Used in either left or right cylinder bank. COMP HT: 1.747 PIN DIA: .9898 Offset	1433 STD. .020 .030 .040 .060	2-5/64, 1-3/16	3878227 3878228 FM 460P	
V8-396 6.5L 4.1250(IN) 104.8(MM) CHEVY ENGINE	1970 9.3 w/96.4cc		.132" high crown. Use Std. size piston for .030" o/s 396 application. Used in either left or right cylinder bank. COMP HT: 1.747 PIN DIA: .9898 Offset	1445 STD. .020 .030 .040 .060	2-5/64, 1-3/16	3969981 3993849 FM 402P	

GENERAL MOTORS

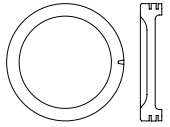
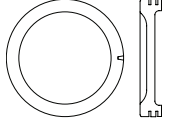
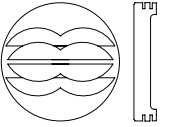
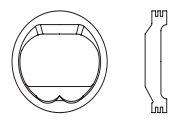
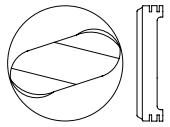
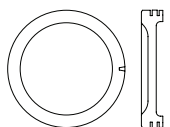
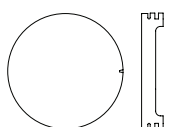
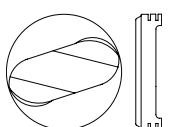
CYL BORE ENGINE	YEAR COMP. RATIO	VIN CODE	NOTES	PART NO. SIZE	RINGS	O.E. ASSY. NO. INTERCHANGE	HEAD SHAPE
V8-400 6.6L 4.1250(IN) 104.8(MM) CHEVY ENGINE	1970-80 8.5		Small Block. 3.460" dia. head recess .150" deep. COMP HT: 1.540 PIN DIA: .9273 Offset	1443 STD. .020 .030 .040 .060	2-5/64, 1-3/16	3972160 3991457 329245 FM 400AP	
V8-400 6.6L 4.1250(IN) 104.8(MM) CHEVY ENGINE	1970-80 8.5		Small Block. Hypereutectic. 3.460" dia. head recess .150" deep. Coated skirts. COMP HT: 1.540 PIN DIA: .9273 Offset	1443HC STD. .020 .030 .040 .060	2-5/64 1-3/16	 FM H400CP	
V8-400 6.6L 4.1200(IN) 104.6(MM) PONTIAC ENGINE	1967-79 8.2		Flat top with 8 valve reliefs. Fits both 14° and 20° heads. COMP HT: 1.700 PIN DIA: .9805 Offset	1526 STD. .020 .030 .040 .060	2-5/64 1-3/16	9788366 9788369 478810 499053 FM 411NP	
V8-401 6.6L 4.1870(IN) 106.35(MM) BUICK ENGINE	1959-66 10.2 9.8		Domed head .370 High 9.8 to 1 comp. Nailhead. COMP HT: 1.912 PIN DIA: .9996	1717 STD. .020 .030 .040 .060 .080 .100	5/64 5/64 3/16	1185486 FM 69P	
V8-402 6.6L 4.1250(IN) 104.8(MM) CHEVY ENGINE	1970-72 8.3 9.4 w/96.4cc		Big Block. .132" high crown. Used in either left or right cyl. bank. COMP HT: 1.747 PIN DIA: .9898 Offset	1445 STD. .020 .030 .040 .060	2-5/64, 1-3/16	3969981-2 3993861-2 FM 402P	
V8-403 6.6L 4.3510(IN) 110.5(MM) OLDSMOBILE ENGINE	1977-79 7.9		3.230" dia. head recess .146" deep. COMP HT: 1.595 PIN DIA: .9805 Offset	1635 STD. .020 .030 .040 .060	2-5/64 1-3/16	556265 FM 466NP	
V8-425 7.0L 4.0820(IN) 103.7(MM) CADILLAC ENGINE	1977-79 8.2		Flat head. COMP HT: 2.003 PIN DIA: .9997 Offset	1818 STD. .020 .030 .040 .060	2-5/64, 1-3/16	3634230 3634232 FM 473P	
V8-427 7.0L 4.2500(IN) 107.95(MM) CHEVY ENGINE	1966-69 9.5		.140" crown. Used in either left or right cylinder bank. COMP HT: 1.750 PIN DIA: .9898 Offset	1434 STD. .020 .030 .040 .060	2-5/64, 1-3/16	3888327-8 FM 412P	

GENERAL MOTORS

CYL BORE ENGINE	YEAR COMP. RATIO	VIN CODE	NOTES	PART NO. SIZE	RINGS	O.E. ASSY. NO. INTERCHANGE	HEAD SHAPE
V8-427 7.0L 4.2500(IN) 107.95(MM) CHEVY ENGINE	1968-84 8.0		Flat head w/1 valve relief. Truck engine. Tall deck. Truck block. COMP HT: 2.160 PIN DIA: .9898 Center	1440D STD. .020 .030 .040 .060 .080	1-3/32, 2-5/64, 1-3/16 Iron Top Groove	3893251 FM H989CP	
V8-427 7.0L 4.2500(IN) 107.95(MM) CHEVY ENGINE	1984-93		2.900" off center combustion recess .100" deep w/1 valve relief. Truck engine. Tall deck. Truck block. COMP HT: 2.160 PIN DIA: .9898 Center	3401D STD. .020 .030 .040 .060	1-3/32, 2-5/64, 1-3/16 Iron Top Groove	10106490 3893251 14087482 FM H604CP	
V8-430 7.0L 4.1875(IN) 106.4(MM) BUICK ENGINE	1967-69 9.9		3.480" dia. head recess .090" deep. COMP HT: 1.942 PIN DIA: .9997 Offset	1728 STD. .020 .030 .040 .060	2-5/64, 1-3/16	1395521 1394210 FM 368P	
V8-454 7.4L 4.2500(IN) 107.95(MM) CHEVY ENGINE	1970-83 9.0 8.2		Flat head piston w/2 valve reliefs. Used in either left or right cylinder bank. For 1970 replace in full sets only. COMP HT: 1.627 PIN DIA: .9898 Offset	1448 STD. .020 .030 .040 .060 .080 .100 .110	2-5/64, 1-3/16	3976015-6 3993874 353058 340206 FM 426NP	
V8-454 7.4L 4.2500(IN) 107.95(MM) CHEVY ENGINE	1970-83 9.0 8.2		Hypereutectic. Flat head piston w/2 valve reliefs. Used in either left or right cylinder bank. For 1970 replace in full sets only. COMP HT: 1.627 PIN DIA: .9898 Offset	1448H STD. .020 .030 .040 .060 .080 .100 .110	2-5/64 1-3/16	 FM H661P	
V8-454 7.4L 4.2500(IN) 107.95(MM) CHEVY ENGINE	1970-83 9.0 8.2		Hypereutectic. Flat head piston w/2 valve reliefs. Used in either left or right cylinder bank. For 1970 replace in full sets only. Coated skirts. COMP HT: 1.627 PIN DIA: .9898 Offset	1448HC STD. .020 .030 .040 .060 .080 .100 .110	2-5/64 1-3/16	 FM H661CP	
V8-454 7.4L 4.2500(IN) 107.95(MM) CHEVY ENGINE	1981-90 8.9 9.1		Hypereutectic. 2.000" dia. head recess .065" deep w/2 valve reliefs. Truck engine. *Same as 3403H with "COATED SKIRTS". Not intended for Racing applications. COMP HT: 1.627 PIN DIA: .9898 Offset	3403HC STD. .020 .030 .040 .060	2-5/64, 1-3/16	14071100 10106471 14071100 10048941 340209 FM H518CP	
V8-454 7.4L 4.2500(IN) 107.95(MM) CHEVY ENGINE	1991-98 8.75	J N	Hypereutectic. L19 engine. 2.000" dia. head recess .050" deep w/2 valve reliefs. Not intended for Racing applications. COMP HT: 1.627 PIN DIA: .9898 Offset	3408H STD. .020 .030 .040 .060	2-5/64, 1-3/16 Shallow Groove	12506746 10126746 10166822 12522358	

GENERAL MOTORS

CYL BORE ENGINE	YEAR COMP. RATIO	VIN CODE	NOTES	PART NO. SIZE	RINGS	O.E. ASSY. NO. INTERCHANGE	HEAD SHAPE
V8-454 7.4L 4.2500(IN) 107.95(MM) CHEVY ENGINE	1991-98 8.75	J N	Hypereutectic. L19 engine. 2.000" dia. head recess .050" deep w/2 valve reliefs. *Same as 3408H with "COATED SKIRTS". Not intended for Racing applications. COMP HT: 1.627 PIN DIA: .9898 Offset	3408HC STD. .020 .030 .040 .060	2-5/64, 1-3/16 Shallow Groove	12506746 10126746 10166822 12522358 FM H727CP	
V8-454 7.4L 4.2500(IN) 107.95(MM) CHEVY ENGINE	1996-00 9.1	B J	Hypereutectic. Flat head w/2 valve reliefs. Used in left or right cylinder bank. Not intended for Racing applications. COMP HT: 1.627 PIN DIA: .9898 Offset	3440H STD. .020 .030 .040 .050 .060	2-5/64 1-3/16 Shallow Groove	12555794	
V8-454 7.4L 4.2500(IN) 107.95(MM) CHEVY ENGINE	1996-00 9.1	B J	Hypereutectic. Flat head w/2 valve reliefs. Used in left or right cylinder bank. Not intended for Racing applications. *Same as 3440H with "COATED SKIRTS". COMP HT: 1.627 PIN DIA: .9898 Offset	3440HC STD. .020 .030 .040 .050 .060	2-5/64 1-3/16 Shallow Groove	12555794 FM H749CP	

More 454 listings in **MerCruiser**, page 83.

V8-455 7.5L 4.3130(IN) 109.5(MM) BUICK ENGINE	1970-76 8.4		3.610" dia. head recess .245" deep. COMP HT: 1.955 PIN DIA: .9997 Offset	1730 STD. .020 .030 .040 .060	2-5/64, 1-3/16	1394671 1394852 FM 392AP	
V8-455 7.5L 4.3130(IN) 109.5(MM) BUICK ENGINE	1970-76 8.4		Hypereutectic. 3.610" dia. head recess .245" deep. COMP HT: 1.955 PIN DIA: .9997 Offset	1730H STD. .020 .030 .040 .060	2-5/64 1-3/16	FM 392AP	
V8-455 7.5L 4.1250(IN) 104.8(MM) OLDSMOBILE ENGINE	1968-76 8.4		3.031" dia. head recess .320" deep. COMP HT: 1.720 PIN DIA: .9805 Offset	1630 STD. .020 .030 .040 .060	2-5/64 1-3/16	400571 231110 FM 344P	
V8-455 7.5L 4.1250(IN) 104.8(MM) OLDSMOBILE ENGINE	1968-76 10.1		2.940" dia. head recess .120" deep. COMP HT: 1.720 PIN DIA: .9805 Offset	1631 STD. .020 .030 .040 .060	2-5/64 1-3/16	400561 FM 369P	

GENERAL MOTORS

CYL BORE ENGINE	YEAR COMP. RATIO	VIN CODE	NOTES	PART NO. SIZE	RINGS	O.E. ASSY. NO. INTERCHANGE	HEAD SHAPE
V8-455 7.5L 4.1500(IN) 105.4(MM) PONTIAC ENGINE	1970-76 8.0		Flat head w/4 valve reliefs. COMP HT: 1.480 PIN DIA: .9805 Offset	1525 STD. .020 .030 .040 .060	1-5/64 1-1/16 1-3/16	478812 485804 499052 FM 417NP	
V8-472 7.7L 4.3000(IN) 109.2(MM) CADILLAC ENGINE	1968-74 8.5		Rectangular head recess .380" deep. COMP HT: 2.004 PIN DIA: .9997 Offset	1814 STD. .020 .030 .040 .060	2-5/64, 1-3/16	3633091 3633454 3633556 FM 351NP	
V8-496 8.1L 4.2500(IN) 107.95(MM) CHEVY ENGINE	2001-04 9.1	G	Hypereutectic. Flat head w/2 valve reliefs. Truck engine. "COATED SKIRTS". Floating Pin. COMP HT: 1.345 PIN DIA: 1.0400 Offset	3494HC STD. .010 .020 .030 .040 .060	2-2.0mm 1-4.0mm Shallow Groove	12569473 FM H880CP	
V8-496 8.1L 4.250(IN) 107.95(MM) CHEVY ENGINE	2001-04 9.1	G	Hypereutectic. Flat head w/ 2 valve reliefs. ANODIZED CROWN AND TOP RING GROOVE Truck engine. "COATED SKIRTS" Floating Pin COMP HT: 1.345 PIN DIA: 1.0400 Offset	3494HCA STD. .010 .020 .040 .060	2-2.0mm 1-4.0mm Shallow Groove	12569473 FM H880CP	
V8-500 8.2L 4.3000(IN) 109.2(MM) CADILLAC ENGINE	1970-73 8.5		Oblong head recess .397" deep. COMP HT: 1.883 PIN DIA: .9997 Offset	1815 STD. .020 .030 .040 .060	2-5/64, 1-3/16	3633561 FM 609P	
V8-500 8.2L 4.3000(IN) 109.2(MM) CADILLAC ENGINE	1974-76 8.1		2.500" dia. head recess .110" deep. COMP HT: 1.882 PIN DIA: .9997 Offset	1817 STD. .020 .030 .040 .060	2-5/64, 1-3/16	3633913 3633951 FM 609P	

HOLDEN

L6-186 3.0L 3.6267(IN) 92.11(MM) HOLDEN ENGINE			Hypereutectic OHV Unleaded Petrol Dish - 2.500" dia. by .075" deep Press Pin COMP HT: 1.780 PIN DIA: .866 Offset	1768H STD. .030 .040 .060	5/64 5/64 3/16	RP3001	
---	--	--	--	--	----------------------	--------	--

CYL BORE ENGINE	YEAR COMP. RATIO	VIN CODE	NOTES	PART NO. SIZE	RINGS	O.E. ASSY. NO. INTERCHANGE	HEAD SHAPE
V6-186 3.0L 3.6267(IN) 92.11(MM) HOLDEN ENGINE			Hypereutectic Flat Top No Valve Reliefs Press Pin COMP HT: 1.780 PIN DIA: .866 Offset	1769H STD. .030 .040 .060 .080	5/64 5/64 3/16	RP3000	
V6-195 3.2L 3.5039(IN) 89(MM) HOLDEN ENGINE	2006- Present		Hypereutectic .018" dome with four valve reliefs DOHC 24VCT EFI ULP Engine Code - LU1 "COATED SKIRTS" COMP HT: 1.262 PIN DIA: .945 Offset	1766HC STD. .25mm .5mm	1.2mm 1.5mm 2.5mm	RP3200	
L-6 202 3.3L 3.6270(IN) 92.126(MM) BUICK HOLDEN ENGINE			Hypereutectic Flat Top .050 Offset Pin COMP HT: 1.685 PIN DIA: .866 Offset Not intended for racing applications	1756H STD. .020 .030 .040 .060	2-1.5mm 1-4.0mm	RA9119A	
L-6 202 3.3L 3.6270(IN) 92.126(MM) BUICK HOLDEN ENGINE			Hypereutectic, Dish 2.625" dia. .020" deep .050 Offset Pin COMP HT: 1.685 PIN DIA: .866 Offset Not Intended for racing applications	1762H STD. .020 .030 .040 .060	2-1.5mm 1-4.0mm	RA9096A	
L-6 202 3.3L 3.6267(IN) 92.118(MM) BUICK HOLDEN ENGINE			Hypereutectic, Dish 3.180" dia. .059" Deep Center Contoured to .140 outer Dish Depth .060 Offset Pin COMP HT: 1.660 PIN DIA: .866 Offset	1763H STD. .020 .030 .040 .060	2-5/64 1-3/16	RP3301	
V6-220 3.6L 3.7008(IN) 94.0(MM) BUICK HOLDEN ENGINE			Hypereutectic, Dish 3.280" dia. .039" Deep Dish 4 Valve Reliefs .030 Offset Floating Pin "COATED SKIRTS" COMP HT: 1.262 PIN DIA: .944 Offset	1765HC STD. .25mm .5mm .75mm 1.0mm	1-1.2mm 1-1.5mm 1-2.5mm	RP3601	
V6-220 3.6L 3.7008(IN) 94.0(MM) BUICK HOLDEN ENGINE	2004-11	7 D V	Hypereutectic, Flat Top 4 Valve Reliefs .030 Offset Floating Pin "COATED SKIRTS" LY7 Engine. COMP HT: 1.262 PIN DIA: .944 Offset	1758HC STD. .25mm .5mm .75mm 1.0mm	1-1.2mm 1-1.5mm 1-2.5mm	RP3600S	
V6-231 3.8L 3.8000(IN) 96.52(MM) BUICK ENGINE	1988-93 8.5	C L	Hypereutectic. 3.100" dia. head recess .250" deep. SFI. Not intended for Racing applications. COMP HT: 1.366 PIN DIA: .9054 Offset	1738H STD. .5mm .75mm 1.0mm 1.5mm	2-1.5mm 1-3.0mm Shallow Groove	25533087 24501072 FM H558P	

HOLDEN

CYL BORE ENGINE	YEAR COMP. RATIO	VIN CODE	NOTES	PART NO. SIZE	RINGS	O.E. ASSY. NO. INTERCHANGE	HEAD SHAPE
V6-231 3.8L 3.8000(IN) 96.52(MM) BUICK HOLDEN ENGINE			Hypereutectic, Center Raised Dish Contoured .315" Deep Outer Dish 3.150" Diameter Dish COMP HT: 1.449 PIN DIA: .905 Offset	1751H	1-1.2mm	RP3801A	
				STD. .020 .030 .040 .060	1-1.5mm 1-3mm		
V6-231 3.8L 3.8000(IN) 96.52(MM) BUICK HOLDEN ENGINE		V-N V-R	Hypereutectic. 2.948" Dia. Dish .213" Deep. .020 Offset Pin COMP HT: 1.425 PIN DIA: .905 Offset Not intended for racing applications	1752H	1-1.2mm	RP9380	
				STD. .020 .030 .040 .060	1-1.5mm 1-3mm		
V6-231 3.8L 3.8000(IN) 96.52(MM) BUICK HOLDEN ENGINE	1985-88	V-N V-P	Hypereutectic, Center Raised Dish Contoured .252" Deep Outer Dish 3.070" Diameter Dish .020 Offset Pin COMP HT: 1.398 PIN DIA: .905 Offset	1753H	2-1.5mm	RP3800A	
				STD. .020 .030 .040 .060	1-3mm		
V6-231 3.8L 3.8000(IN) 96.52(MM) BUICK HOLDEN ENGINE			Hypereutectic, 3.208" Dia. Dish 2.61cc .020" Deep Dish Holden Ecotec Engine .030 Offset Floating Pin "COATED SKIRTS" COMP HT: 1.087 PIN DIA: .905 Offset	1754HC	1-1.2mm	RP9381S	
				STD. .010 .020 .030 .040	1-1.5mm 1-2mm		
V6-231 3.8L 3.8000(IN) 96.52(MM) BUICK HOLDEN ENGINE			Hypereutectic, 3.187" Dia. Dish 7.25cc .062" Deep Dish Holden Ecotec Engine .030 Offset Floating Pin COMP HT: 1.080 PIN DIA: .866 Offset	1755H	1-1.2mm	RP3802	
				STD. .010 .020 .030 .040	1-1.5mm 1-2mm		
V8-253 4.1L 3.6270(IN) 92.126(MM) BUICK HOLDEN ENGINE			Hypereutectic Flat Top .050 Offset Pin COMP HT: 1.685 PIN DIA: .927 Offset Not intended for racing applications	1757H	2-1.5mm	RP9119A	
				STD. .020 .030 .040 .060	1-4mm		
V8-253 4.1L 3.627(IN) 92.12(MM) HOLDEN ENGINE	1969-86		Hypereutectic OHV 2V Low Comp Unleaded Fuel Dish - 2.500" dia. by .083" deep Press Pin COMP HT: 1.686 PIN DIA: .927 Offset	1767HC	5/64	RP4201	
				STD. .020 .030 .040 .060	5/64 3/16		
V8-299 4.9L 4.0005(IN) 101.613(MM) BUICK HOLDEN ENGINE			Hypereutectic. 2.756" Dia. Dish .118" Deep Dish .050 Offset Pin COMP HT: 1.719 PIN DIA: .927 Offset Not intended for racing applications	1764H	2-1.5mm	RP4901	
				STD. .020 .030 .040 .060	1-4mm		

HOLDEN

CYL BORE ENGINE	YEAR COMP. RATIO	VIN CODE	NOTES	PART NO. SIZE	RINGS	O.E. ASSY. NO. INTERCHANGE	HEAD SHAPE
V8-299 4.9L 4.0005(IN) 101.613(MM) BUICK HOLDEN ENGINE			Hypereutectic, Flat Top No Valve Reliefs .050 Offset Pin COMP HT: 1.719 PIN DIA: .927 Offset Not intended for racing applications	1760H STD. .020 .030 .040 .060	2-1.5mm 1-4mm		
V8-308 5.0L 4.0005(IN) 101.613(MM) BUICK HOLDEN ENGINE			Hypereutectic, Flat Top No Valve Reliefs .050 Offset Pin COMP HT: 1.692 PIN DIA: .927 Offset Not intended for racing applications	1759H STD. .020 .030 .040 .060	2-1.5mm 1-4mm		
V8-308 5.0L 4.0005(IN) 101.613(MM) BUICK HOLDEN ENGINE			Hypereutectic. 2.877" Dia. Dish .178" Deep. .050 Offset Pin COMP HT: 1.692 PIN DIA: .927 Offset Not intended for racing applications	1761HC STD. .020 .030 .040 .060	2-1.5mm 1-4mm		

HONDA

L4-91.5 1493cc 2.9528(IN) 75.0(MM) HONDA ENGINE	1988-91 9.6		D15B1, B2, B7, B8 engine. OHC. Flat head w/4 valve reliefs. COMP HT: 1.195 PIN DIA: .7480 Offset	9083 STD. .5mm .75mm 1.0mm	1-1.2mm 1-1.5mm 1-2.8mm	13101-PM8-A01 13101-PM3-020 FM 836P	
L4-91.5 1493cc 2.9528(IN) 75.0(MM) HONDA ENGINE	1988-91 9.6		Hypereutectic. D15B1, B2, B7, B8 engine.. OHC. Flat head w/4 valve reliefs. "COATED SKIRTS" COMP HT: 1.195 PIN DIA: .7480 Offset	9083HC STD. .5mm .75mm 1.0mm	1-1.2mm 1-1.5mm 1-2.8mm Shallow Groove	FM H836CP	
L4-131.5 2156cc 3.3465(IN) 85.0(MM) HONDA ENGINE	1990-93 8.8		Hypereutectic. F22A1 engine. Accord all except SE. 2.840" dia. head recess .130" deep w/4 valve reliefs. Not intended for Racing applications. COMP HT: 1.190 PIN DIA: .8662 Offset	9076H STD. .5mm .75mm 1.0mm	2-1.2mm 1-2.8mm	13101-PT3-A00 13101-PT3-A01 FM H828P	



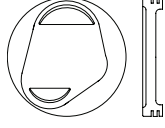
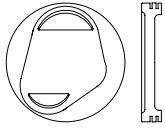

HYUNDAI

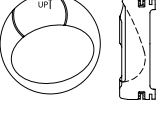
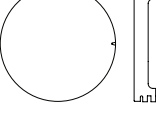
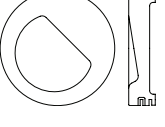
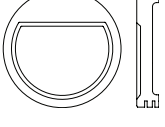
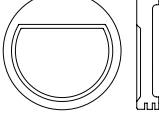
CYL BORE ENGINE	YEAR COMP. RATIO	VIN CODE	NOTES	PART NO. SIZE	RINGS	O.E. ASSY. NO. INTERCHANGE	HEAD SHAPE
V6-181 2972cc 3.5866(IN) 91.1(MM) MITSUBISHI ENGINE	1989-92 8.9		G6AT Engine. EFI. Triangular head recess .098" deep w/2 valve reliefs. COMP HT: 1.247 PIN DIA: .8665 Offset	3201 STD. .5mm .75mm 1.0mm	2-1.5mm 1-4.0mm	MD119671R MD152563L FM 6678P	
V6-181 2972cc 3.5866(IN) 91.1(MM) MITSUBISHI ENGINE	1990 8.85		Hypereutectic. Triangular head recess .098" deep w/2 valve reliefs. "COATED SKIRTS". Not intended for Racing applications. COMP HT: 1.247 PIN DIA: .8665 Offset	3201HC STD. .5mm .75mm 1.0mm	2-1.5mm 1-4.0mm	 FM H834CP	

INTERNATIONAL / NAVISTAR

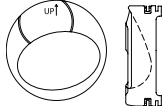
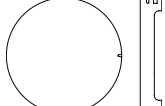
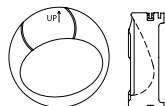
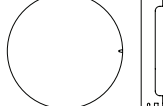
L4-152 2.5 L 3.8750(IN) 98.4(MM) IHC ENGINE	8.2		Contoured head. Not destroyed. Scout. COMP HT: 2.200 PIN DIA: 1.0625 Center	7185D STD. .020 .030 .040 .050 .060	2-3/32 1-3/16 Iron Top Groove	216160R11 FM 992P	
L4-152 2.5 L 3.8750(IN) 98.4(MM) IHC ENGINE	8.2		Flat head. Not destroyed. Exhaust emission engine. COMP HT: 1.891 PIN DIA: 1.0625 Center	7187D STD. .020 .030 .040 .060	2-3/32 1-3/16 Iron Top Groove	334218-C2 334218-C31 FM H997CP	
L4-196 3.2 L 4.1250(IN) 104.8(MM) IHC ENGINE	8.0		Offset "D" shaped head recess .340" deep. Not destroyed. Exhaust emission engine. COMP HT: 1.907 PIN DIA: 1.0625 Center	7186D STD. .020 .030 .040 .060	2-3/32 1-3/16 Iron Top Groove	337144-C1 FM H861CP	
L6-232 3.8L 3.7500(IN) 95.25(MM) AMC ENGINE	8.3		"D" shaped head recess .120" deep. Replace in full sets only. COMP HT: 1.581 PIN DIA: .9310 Offset	2226 STD. .020 .030 .040 .060	2-5/64, 1-3/16	3204957 4488672 8127654 FM 456NP	
L6-258 4.2L 3.7500(IN) 95.25(MM) AMC ENGINE	8.3		"D" shaped head recess .120" deep. Replace in full sets only. COMP HT: 1.581 PIN DIA: .9310 Offset	2226 STD. .020 .030 .040 .060	2-5/64, 1-3/16	4488672 8127654 3204957 FM 456NP	

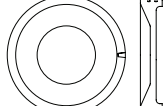

INTERNATIONAL / NAVISTAR

CYL BORE ENGINE	YEAR COMP. RATIO	VIN CODE	NOTES	PART NO. SIZE	RINGS	O.E. ASSY. NO. INTERCHANGE	HEAD SHAPE
V8-304 5.0 L 3.8750(IN) 98.4(MM) IHC ENGINE	8.2		V304 engine. Contoured head. Not destroyed. COMP HT: 2.200 PIN DIA: 1.0625 Center	7058D STD. .020 .030 .040 .060	2-3/32 1-3/16 Iron Top Groove	216160R11 FM 992P	
V8-304 4.9 L 3.8750(IN) 98.4(MM) IHC ENGINE	8.2		Flat head. Not destroyed. Exhaust emission engine. COMP HT: 1.891 PIN DIA: 1.0625 Center	7082D STD. .020 .030 .040 .060	2-3/32 1-3/16 Iron Top Groove	334218-C2 334218-C31 FM H997CP	
V8-345 5.6 L 3.8750(IN) 98.4(MM) IHC ENGINE	8.2		V345 engine. Contoured head. Not destroyed. COMP HT: 2.200 PIN DIA: 1.0625 Center	7058D STD. .020 .030 .040 .060	2-3/32 1-3/16 Iron Top Groove	216160R11 FM 992P	
V8-345 5.6 L 3.8750(IN) 98.4(MM) IHC ENGINE	8.2		Flat head. Not destroyed. Exhaust emission engine. COMP HT: 1.891 PIN DIA: 1.0625 Center	7082D STD. .020 .030 .040 .060	2-3/32 1-3/16 Iron Top Groove	334218-C2 334218-C31 FM H997CP	
V8-392 6.4 L 4.1250(IN) 104.8(MM) IHC ENGINE	8.0		Offset "D" shaped head recess .340" deep. Not destroyed. Exhaust emission engine. COMP HT: 1.907 PIN DIA: 1.0625 Center	7080D STD. .020 .030 .040 .060	2-3/32 1-3/16 Iron Top Groove	337144-C1 FM H996CP	
V8-404 6.6 L 4.1250(IN) 104.8(MM) IHC ENGINE	1975-80 8.0		MV404 engine. 3.500" dia. head recess .325" deep. Not destroyed. COMP HT: 1.920 PIN DIA: 1.0201 Center	7084D STD. .020 .030 .040 .060	2-3/32 1-3/16 Iron Top Groove	446494C93 FM H999P	
V8-421 6.9L 4.0000(IN) 101.6(MM) IHC ENGINE	1983-86 19.7		Truck Diesel. Swirl chamber. (6.6cc cup). B Series. (Supersedes 7085D, different Lockring grooves). COMP HT: 1.945 PIN DIA: 1.1101 Center	7096D STD. .010 .020 .030 .040 .060	2-5/64 1-7/64 Iron Top Groove	1805212C1 1805851C1 FM H729CP	
V8-445 7.3L 4.1100(IN) 104.4(MM) IHC ENGINE	1989-94		Non-Turbo Diesel. Ricardo cup. Truck engine. COMP HT: 1.950 PIN DIA: 1.1101 Center	7098D STD. .010 .020 .030 .040	1-3.0mm 1-2.0mm 1-3.5mm Iron Top Groove	E9TZ6102A F2TZ6102A FM 2745PN	

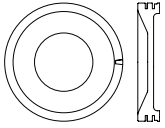
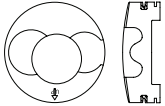
INTERNATIONAL / NAVISTAR

CYL BORE ENGINE	YEAR COMP. RATIO	VIN CODE	NOTES	PART NO. SIZE	RINGS	O.E. ASSY. NO. INTERCHANGE	HEAD SHAPE
V8-446 7.3 L 4.1250(IN) 104.8(MM) IHC ENGINE	1975-80 8.0		MV446 engine. 3.500" dia. head recess .325" deep. Not destroyed. COMP HT: 1.920 PIN DIA: 1.0201 Center	7084D STD. .020 .030 .040 .060	2-3/32 1-3/16 Iron Top Groove	446494C93 FM H999P	
V8-551 9.0 L 4.5100(IN) 114.6(MM) IHC ENGINE			Spherical dome w/combustion bowl and 2 valve reliefs. Not destroyed. COMP HT: 2.866 PIN DIA: 1.5000 Center	7099D STD. .020 .030	Keystone 1-3/32 1-3/16 Iron Top Groove	FM 2673PN	

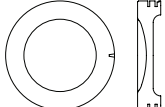
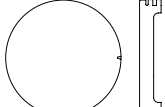
ISUZU

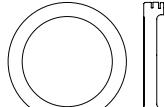
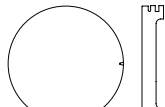
L4-110 1817cc 3.3071(IN) 84.0(MM) ISUZU ENGINE	1976-82 8.4		G180Z engine. 2.800" dia. head recess .068" deep. COMP HT: 1.435 PIN DIA: .8665 Offset	1462 STD. .5mm .75mm 1.0mm 1.5mm	2-2.0mm 1-4.0mm	94201040 94215088 FM 480P	
L4-119 1949cc 3.4252(IN) 87.0(MM) ISUZU ENGINE	1982-86 9.2		G200Z Engine. Flat head. *Use 1982 ring pack for all years. COMP HT: 1.438 PIN DIA: .8665 Offset	1461 STD. .5mm .75mm 1.0mm	2-2.0mm 1-4.0mm *1982 Ring Pack	94213831 94237469 FM 12216P	
L4-140 2254cc 3.5157(IN) 89.3(MM) ISUZU ENGINE	1986-94 8.6		4ZD1 engine. OHC. 3.050" dia. head recess .140" deep. Fits all 2.3 engines to 7/94 except Calif. to 8/93. COMP HT: 1.516 PIN DIA: .9055 Offset	9084 STD. .5mm .75mm 1.0mm	2-1.5mm 1-4.0mm	8-94438-625-1 FM 12741P	
L4-158.6 2559cc 3.6457(IN) 92.6(MM) ISUZU ENGINE	1988-94 8.3		4ZE1 engine. OHC. 3.180" dia. head recess .030" deep. Non-turbo. COMP HT: 1.416 PIN DIA: .9055 Offset	9085 STD. .5mm .75mm 1.0mm	2-1.5mm 1-4.0mm	8-94163-189-3 FM 13508P	
V6-173 2835cc 3.5039(IN) 89.0(MM) CHEVY ENGINE	1985-93 8.5	R	Flat head. COMP HT: 1.599 PIN DIA: .9055 Offset	1478 STD. .5mm .75mm 1.0mm 1.5mm	1-1.5mm 1-2.0mm 1-4.75mm Shallow Groove	14092910 8-14092-910-0 FM 516P	

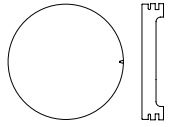
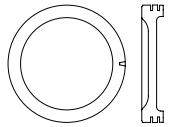
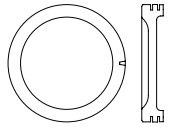
CYL BORE ENGINE	YEAR COMP. RATIO	VIN CODE	NOTES	PART NO. SIZE	RINGS	O.E. ASSY. NO. INTERCHANGE	HEAD SHAPE
V6-173 2.8L 3.5039(IN) 89.0(MM) CHEVY ENGINE	1985-93 8.5	R	Flat head. Similar to 1463 except ring pack. *Same as 1478 with "COATED SKIRTS". COMP HT: 1.599 PIN DIA: .9055 Offset	1478C STD. .5mm .75mm 1.0mm 1.5mm	1-1.5mm 1-2.0mm 1-4.75mm Shallow Groove	14092910 FM 516CP	
V6-191 3130cc 3.5039(IN) 89.0(MM) CHEVY ENGINE	1990-94 8.8	Z	2.950" dia. head recess .105" deep. Iron Head. TBI. APV only. COMP HT: 1.450 PIN DIA: .9054 Offset	1486 STD. .5mm .75mm 1.0mm 1.5mm	2-1.5mm 1-4.0mm Shallow Groove	8-10070-145-0 10087699	
V6-191 3130cc 3.5039(IN) 89.0(MM) CHEVY ENGINE	1990-94 8.8	Z	Hypereutectic. 2.950" dia. head recess .105" deep. Iron Head. TBI. APV only. "COATED SKIRTS". Not intended for Racing applications. COMP HT: 1.450 PIN DIA: .9054 Offset	1486HC STD. .5mm .75mm 1.0mm 1.5mm	2-1.5mm 1-4.0mm Shallow Groove	8-10070-145-0 10087699 FM H562CP	

MAZDA

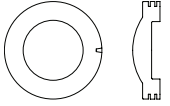
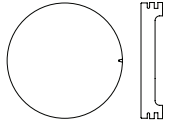
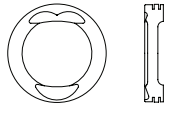
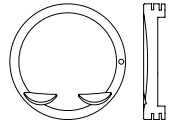
L4-109.6 1797cc 3.0709(IN) 78.0(MM) MAZDA ENGINE	1972-80 8.3		VB engines. Domed head .310" high. COMP HT: 1.455 PIN DIA: .8665 Offset	1168 STD. .5mm .75mm 1.0mm 1.5mm	2-1.5mm 1-4.0mm	3879-23-2000 FM 485P	
L4-122 1970cc 3.1496(IN) 80.0(MM) FORD ENGINE	1979-82 8.0		Flat head. Use early design ring pack. COMP HT: 1.406 PIN DIA: .7868 Offset	1182 STD. .5mm .75mm 1.0mm 1.5mm	1-1.2mm 1-1.5mm 1-4.0mm	D97Z6108A FM 12215P	
L4-122 1998cc 3.3858(IN) 86.0(MM) MAZDA ENGINE	1983-87 8.6		FE engine. 2.380" dia. head recess .100" deep w/3 valve reliefs. COMP HT: 1.320 PIN DIA: .8657 Offset	9125 STD. .5mm .75mm 1.0mm	2-1.5mm 1-4.0mm	FEY311SAOA FM 12306P	
L4-122 2.0L 3.4449(IN) 87.5(MM) MAZDA ENGINE	2004-08	L F	Hypereutectic, 2.960" Dia. .010 Deep Dish w/2 valve reliefs. .030 Offset Pin "COATED SKIRTS" COMP HT: 1.122 PIN DIA: .826 Offset	9134HC STD. .5mm 1.0mm	2-1.2mm 1-2.5mm		

MAZDA

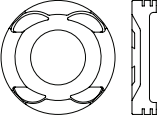
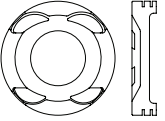
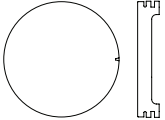
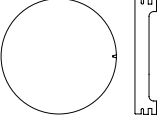
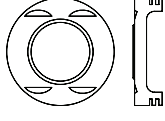
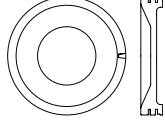
CYL BORE ENGINE	YEAR COMP. RATIO	VIN CODE	NOTES	PART NO. SIZE	RINGS	O.E. ASSY. NO. INTERCHANGE	HEAD SHAPE
L4-134 2184cc 3.3858(IN) 86.0(MM) MAZDA ENGINE	1987-92 8.6	C L	F2 engine. 2.610" dia. head recess .247" deep w/4 valve reliefs. Non-turbo. COMP HT: 1.420 PIN DIA: .8657 Offset	3100 STD. .5mm .75mm 1.0mm	2-1.5mm 1-4.0mm	E92Z6108A FM 548P	
L4-134 2184cc 3.3858(IN) 86.0(MM) MAZDA ENGINE	1988-92 7.8	C L	Hypereutectic. F2 engine. 2.570" dia. head recess .355" deep w/4 valve reliefs. Turbo. Not intended for Racing applications. COMP HT: 1.420 PIN DIA: .8657 Offset	3121H STD. .5mm .75mm 1.0mm	2-1.5mm 1-4.0mm	E92Z6108D FM H549P	
V6-182 3.0L 3.5039(IN) 89.0(MM) FORD ENGINE	1986-95 9.3	H R	Hypereutectic. Flat head. Not intended for Racing applications. COMP HT: 1.535 PIN DIA: .9122 Offset	1193H STD. .5mm .75mm 1.0mm	2-1.5mm 1-4.0mm Shallow Groove	E6DZ6108A-B E7DZ6108A-B F47Z6108A FM H497P	
V6-182 3.0L 3.5039(IN) 89.0(MM) FORD ENGINE	1986-95 9.3	H R	Hypereutectic. Flat head. Not intended for Racing applications. "COATED SKIRTS". COMP HT: 1.535 PIN DIA: .9122 Offset	1193HC STD. .5mm .75mm 1.0mm	2-1.5mm 1-4.0mm Shallow Groove	E6DZ6108A-B E7DZ6108A-B F47Z6108A FM H497P	
V6-181 3.0L 3.5039(IN) 89.0(MM) MAZDA FORD ENGINE	1996-06 10.0	S	Hypereutectic. Duratec Engine .028" High dome w/4 valve reliefs. "COATED SKIRTS". Not intended for Racing applications. Floating Pin. COMP HT: 1.171 PIN DIA: .8272 Offset	3182HC STD. .25mm .5mm .75mm 1.0mm	1-1.2mm 1-1.5mm 1-3.0mm Shallow Groove	XW4Z-6100-CA FM H881CP	
V6-244 4.0L 3.9527(IN) 100.4(MM) FORD ENGINE	1995-97 9.0		Hypereutectic. B4000. 3.130" dia. head recess .330" deep. Truck. COMP HT: 1.450 PIN DIA: .9450 Offset	3151H STD. .5mm .75mm 1.0mm	1-1.6mm 1-1.75mm 1-3.5mm	F5TZ6100A ZZMB-23-200 FM H667P	

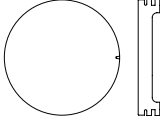

MERCURISER

L4-181 3.0L 4.0000(IN) 101.6(MM) CHEVY ENGINE			Hypereutectic. Flat head. Not destroyed. Coated skirts. Marine Engine. COMP HT: 1.625 PIN DIA: .9272	3493HC STD. .020 .030 .040 .060	2-5/64, 1-3/16	736-2343 Casting# 14096624 FM H897CP	
--	--	--	---	---	-------------------	---	---

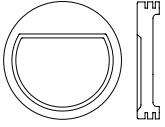
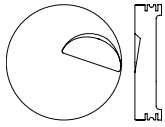
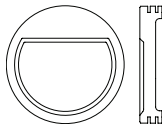
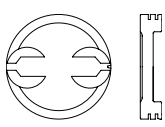
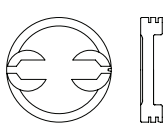
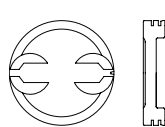
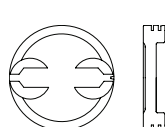
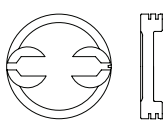

MERCURISER

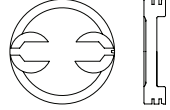
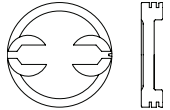
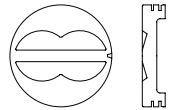
CYL BORE ENGINE	YEAR COMP. RATIO	VIN CODE	NOTES	PART NO. SIZE	RINGS	O.E. ASSY. NO. INTERCHANGE	HEAD SHAPE
L4-181 3.0L 4.0000(IN) 101.6(MM) CHEVY ENGINE	1982-89		Hypereutectic. Mercruiser marine engine. 3.200" dia. head recess .130" deep (14cc cup). Not destroyed. COMP HT: 1.625 PIN DIA: .9273 Offset	1491H STD. .020 .030 .040 .060	2-5/64, 1-3/16	3963663 FM H896CP	
L4-224 3.7L 4.3600(IN) 110.7(MM) MERCURY MARINE			Hypereutectic. Marine engine. Flat head w/1 valve relief. COMP HT: 1.755 PIN DIA: 1.0402 Center	3164H STD. .020 .030 .040 .060	2-5/64, 1-3/16		
L6-250 4.1L 3.8750(IN) 98.4(MM) CHEVY ENGINE			"D" shaped head recess .060" deep. "COATED SKIRTS". COMP HT: 1.640 PIN DIA: .9273 Offset	1446C STD. .020 .030 .040 .060	2-5/64, 1-3/16	FM 403CP	
V6-262 4.3L 4.0000(IN) 101.6(MM) CHEVY ENGINE			Hypereutectic. Marine engine. 3.100" dia. head recess .080" deep w/4 valve reliefs. COMP HT: 1.540 PIN DIA: .9273 Offset	3455H STD. .020 .030 .040 .060	2-1.5mm 1-3.0mm Shallow Groove		
V6-262 4.3L 4.0000(IN) 101.6(MM) CHEVY ENGINE			Hypereutectic. 3.140" dia. head recess .070" deep w/4 valve reliefs. Use 1986 & earlier rings. COMP HT: 1.540 PIN DIA: .9273 Offset	3490H STD. .020 .030 .040 .060	2-5/64, 1-3/16		
V6-262 4.3L 4.0000(IN) 101.6(MM) CHEVY ENGINE			Hypereutectic. 3.140" dia. head recess .070" deep w/4 valve reliefs. Use 1986 & earlier rings. *Same as 3490H with "COATED SKIRTS". COMP HT: 1.540 PIN DIA: .9273 Offset	3490HC STD. .020 .030 .040 .060	2-5/64, 1-3/16	H640ACP	
V8-305 5.0L 3.7360(IN) 94.9(MM) CHEVY ENGINE			3.100" dia. head recess .040" deep w/4 valve reliefs. "COATED SKIRTS". COMP HT: 1.540 PIN DIA: .9273 Offset	1493C STD. .020 .030 .040 .060	2-5/64, 1-3/16	FM 536NCP	
V8-305 5.0L 3.7360(IN) 94.9(MM) CHEVY ENGINE			Hypereutectic. Marine engine. 2.830" dia. head recess .140" deep w/4 valve reliefs. COMP HT: 1.560 PIN DIA: .9273 Offset	3452H STD. .020 .030 .040 .060	2-5/64, 1-3/16		

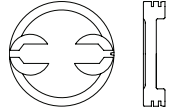
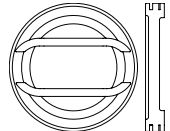
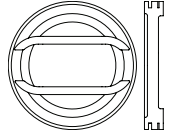
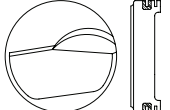
MERCURISER

CYL BORE ENGINE	YEAR COMP. RATIO	VIN CODE	NOTES	PART NO. SIZE	RINGS	O.E. ASSY. NO. INTERCHANGE	HEAD SHAPE
V8-305 5.0L 3.7360(IN) 94.9(MM) CHEVY ENGINE			Hypereutectic. Marine engine. 2.830" dia. head recess .140" deep w/4 valve reliefs. *Same as 3452H with "COATED SKIRTS". COMP HT: 1.560 PIN DIA: .9273 Offset	3452HC STD. .020 .030 .040 .060	2-5/64, 1-3/16	FM H826CP	
V8-350 5.7L 4.0000(IN) 101.6(MM) CHEVY ENGINE			Hypereutectic. 3.140" dia. head recess .070" deep w/4 valve reliefs. Use 1986 & earlier rings. "COATED SKIRTS". COMP HT: 1.540 PIN DIA: .9273 Offset	1476HC STD. .020 .030 .040 .060	2-5/64, 1-3/16	FM H423NCP	
V8-350 5.7L 4.0000(IN) 101.6(MM) CHEVY ENGINE			Hypereutectic. Marine engine. Flat head w/4 valve reliefs. "COATED SKIRTS" COMP HT: 1.560 PIN DIA: .9273 Offset	3437HC STD. .020 .030 .040 .060	2-5/64 1-3/16	FM H345ACP	
V8-350 5.7L 4.0000(IN) 101.6(MM) CHEVY ENGINE			Hypereutectic. Marine engine. 3.010" dia. head recess .062" deep w/2 valve reliefs. "COATED SKIRTS" COMP HT: 1.558 PIN DIA: .9273 Center	3456HC STD. .020 .030 .040 .060	2-5/64, 1-3/16	FM H819CP	
V8-350 5.7L 4.0000(IN) 101.6(MM) CHEVY ENGINE			Hypereutectic. Marine engine. 2.710" dia. head recess .082" deep w/4 valve reliefs. COMP HT: 1.550 PIN DIA: .9273 Offset	3457H STD. .020 .030 .040 .060	2-1.5mm 1-3.0mm Shallow Groove		
V8-350 5.7L 4.0000(IN) 101.6(MM) CHEVY ENGINE			Hypereutectic. Marine engine. 3.300" dia. head recess .185" deep w/2 valve reliefs. COMP HT: 1.540 PIN DIA: .9273 Offset	3462H STD. .020 .030 .040 .060 .080	2-5/64, 1-3/16 Shallow Groove	FM H580P	
V8-350 5.7L 4.0000(IN) 101.6(MM) CHEVY ENGINE			Hypereutectic. Marine engine. 3.300" dia. head recess .185" deep w/2 valve reliefs. *Same as 3462H with "COATED SKIRTS". COMP HT: 1.540 PIN DIA: .9273 Offset	3462HC STD. .020 .030 .040 .060 .080	2-5/64, 1-3/16 Shallow Groove	FM H580CP	
V8-454 7.4L 4.2500(IN) 107.95(MM) CHEVY ENGINE			Hypereutectic. Marine engine. .133" high dome w/1 valve relief. Centered Pin. COMP HT: 1.645 PIN DIA: .9898	3458H STD. .020 .030 .040 .060	2-5/64, 1-3/16		

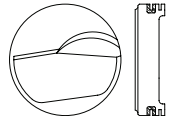
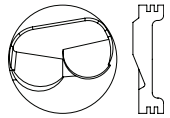
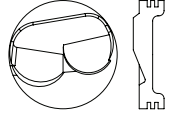
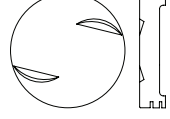
MERCURISER

CYL BORE ENGINE	YEAR COMP. RATIO	VIN CODE	NOTES	PART NO. SIZE	RINGS	O.E. ASSY. NO. INTERCHANGE	HEAD SHAPE
V8-454 7.4L 4.2500(IN) 107.95(MM) GM ENGINE			Hypereutectic, .133" High Dome 1 Valve Relief "COATED SKIRTS" Centered Pin Mercury Marine Engine COMP HT: 1.645 PIN DIA: .990	3458HC STD. .020 .030 .040 .060	2-5/64, 1-3/16		
V8-454 7.4L 4.2500(IN) 107.95(MM) CHEVY ENGINE			Hypereutectic. Marine engine. .230" high dome w/2 valve reliefs. "COATED SKIRTS". Centered Pin. COMP HT: 1.645 PIN DIA: .9898	3475HC STD. .020 .030 .040 .060	2-5/64, 1-3/16	FM H693CP	
V8-454 7.4L 4.2500(IN) 107.95(MM) CHEVY ENGINE			Hypereutectic. Marine engine. .340" high dome w/2 valve reliefs. "COATED SKIRTS". Centered Pin. COMP HT: 1.645 PIN DIA: .9898	3474HC STD. .020 .030 .040 .060	2-5/64, 1-3/16	FM H581CP	
V8-460 7.5L 4.3600(IN) 110.7(MM) FORD ENGINE			Hypereutectic. Flat head w/2 valve reliefs. Marine engine. COMP HT: 1.752 PIN DIA: 1.0402 Offset	3191H STD. .020 .030 .040 .060	2-5/64 1-3/16	FM H535P	
V8-460 7.5L 4.3600(IN) 110.7(MM) FORD ENGINE			Hypereutectic, Flat Top 2 Valve Reliefs "COATED SKIRTS" .060 Offset Pin Marine piston was H now HC COMP HT: 1.752 PIN DIA: 1.040 Offset	3191HC STD. .020 .030 .040 .060	2-5/64 1-3/16	FM H535CP	

MITSUBISHI

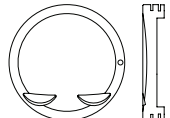
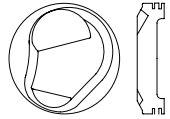
L4-90 1.5L 2.9724(IN) 75.5(MM) MITSUBISHI ENGINE	1990-93 9.2	A	Hypereutectic. 2.560" dia. head recess .020" deep w/2 valve reliefs. Not intended for Racing applications. COMP HT: 1.133 PIN DIA: .7090 Offset	3213H STD. .5mm .75mm 1.0mm	1-1.2mm 1-1.5mm 1-3.0mm	MD144901 FM H13130P	
L4-110 1755cc 3.1732(IN) 80.6(MM) MITSUBISHI ENGINE	1989-94 9.0	B C	4G37 Engine. Dome head .150" high w/2 valve reliefs COMP HT: 1.320 PIN DIA: .7485 Offset	3216 STD. .5mm .75mm 1.0mm	2-1.5mm 1-4.0mm	MD100416	

MITSUBISHI

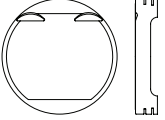
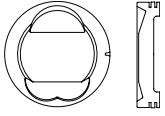
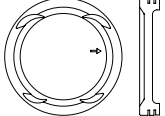
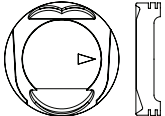
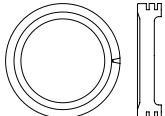
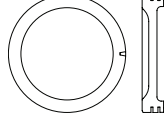
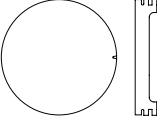
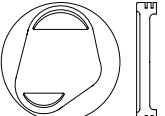

CYL BORE ENGINE	YEAR COMP. RATIO	VIN CODE	NOTES	PART NO. SIZE	RINGS	O.E. ASSY. NO. INTERCHANGE	HEAD SHAPE
L4-110 1834cc 3.1890(IN) 81.0(MM) MITSUBISHI ENGINE	1990-94 9.5	C D	16 Valve SOHC. 113 HP. Dome head .010" high w/2 valve reliefs. COMP HT: 1.210 PIN DIA: .7480 Offset	3220 STD. .5mm .75mm 1.0mm	2-1.2mm 1-2.8mm	MD190610 MD183457 MD174995	
L4-122 1997cc 3.3465(IN) 85.0(MM) MITSUBISHI ENGINE	1983-92 8.5	V	G63B, 4G63 SOHC engine. 2.500" dia. head recess .050" deep w/3 valve reliefs. Use late model ring set. COMP HT: 1.360 PIN DIA: .8267 Offset	3217 STD. .5mm .75mm 1.0mm	2-1.5mm 1-4.0mm Late Style	MD040591 MD100372 FM 13168P	
L4-122 1997cc 3.3465(IN) 85.0(MM) MITSUBISHI ENGINE	1989-92 7.8		Hypereutectic. 4G63 engine. 2.950" dia. head recess .210" deep w/4 valve reliefs. Not intended for Racing applications. COMP HT: 1.360 PIN DIA: .8271 Offset	9123H STD. .5mm .75mm 1.0mm	1-1.2mm 1-1.5mm 1-3.0mm	MD133402 13507P	
L4-143 2351cc 3.4055(IN) 86.5(MM) MITSUBISHI ENGINE	1989-92 8.5	G W	Flat head w/3 valve reliefs. COMP HT: 1.370 PIN DIA: .8267 Offset	3225 STD. .5mm .75mm 1.0mm	2-1.5mm 1-4.0mm	MD105377 FM 12958P	
L4-143 2351cc 3.4055(IN) 86.5(MM) MITSUBISHI ENGINE	1992-01 9.5	G	4G64 Engine. 3.100" dia. head recess .160" deep COMP HT: 1.360 PIN DIA: .8665 Offset	3221 STD. .5mm .75mm 1.0mm	1-1.2mm 1-1.5mm 1-2.8mm	MD188115 MD188998 MD303071	
L4-156 2555cc 3.5866(IN) 91.1(MM) MITSUBISHI ENGINE	1983-89 8.2		Hypereutectic. 2.800" dia. head recess .200" deep. 1984-87 EFI. Turbo. Not intended for Racing applications. COMP HT: 1.365 PIN DIA: .8665 Offset	3210H STD. .5mm .75mm 1.0mm	2-1.5mm 1-4.0mm	MD061248 MD128450 FM 12220P	
L4-156 2555cc 3.5866(IN) 91.1(MM) MITSUBISHI ENGINE	1984-89 8.2		Hypereutectic. Flat head. Not intended for Racing applications. COMP HT: 1.418 PIN DIA: .8665 Offset	1288H STD. .5mm .75mm 1.0mm 1.5mm	2-1.5mm 1-4.0mm	MD071172 MD026921 FM H605P	
V6-181 2972cc 3.5866(IN) 91.1(MM) MITSUBISHI ENGINE	1988-93 8.9	B H S	6G72 engine. Triangular head recess .098" deep w/2 valve reliefs. COMP HT: 1.247 PIN DIA: .8665 Offset	3201 STD. .5mm .75mm 1.0mm	2-1.5mm 1-4.0mm	MD119671R MD152563L FM 6678P	

CYL BORE ENGINE	YEAR COMP. RATIO	VIN CODE	NOTES	PART NO. SIZE	RINGS	O.E. ASSY. NO. INTERCHANGE	HEAD SHAPE
V6-181 2972cc 3.5866(IN) 91.1(MM) MITSUBISHI ENGINE	1989-90 8.85		Hypereutectic. Triangular head recess .098" deep w/2 valve reliefs. "COATED SKIRTS". Not intended for Racing applications. COMP HT: 1.247 PIN DIA: .8665 Offset	3201HC STD. .5mm .75mm 1.0mm	2-1.5mm 1-4.0mm	FM H834CP	
V6-181 2972cc 3.5866(IN) 91.1(MM) MITSUBISHI ENGINE	1993-99 8.85		Hypereutectic. 6G72 and 6G72S SOHC Engines. Triangular head recess .125" deep w/2 valve reliefs. "COATED SKIRTS". Not intended for Racing applications. COMP HT: 1.247 PIN DIA: .8665 Offset	3224HC STD. .5mm .75mm 1.0mm	1-1.2mm 1-1.5mm 1-3.0mm	FM H694CP	
L4-97 1597cc 2.9921(IN) 76.0(MM) NISSAN ENGINE	1983-88 9.4		E16, E16I & E16S engines. 2.350" dia. head recess .360" deep. 1987-88 EFI. COMP HT: 1.262 PIN DIA: .7480 Offset	9072 STD. .5mm .75mm 1.0mm	2-1.5mm 1-4.0mm	12010-33M22 12010-31M12 FM 12328P	
L4-97.1 1595cc 3.2677(IN) 83.0(MM) NISSAN ENGINE	1969-73 8.3		L16 engine. 2.750" dia. head recess .055" deep. COMP HT: 1.480 PIN DIA: .8267 Offset	9044 STD. .5mm .75mm 1.0mm 1.5mm	2-2.0mm 1-4.0mm	12010-23002 FM 12114NP	
L4-97.5 1597cc 2.9921(IN) 76.0(MM) NISSAN ENGINE	1986-92		E16 engine. Spherical head recess .370" deep w/2 valve reliefs. COMP HT: 1.279 PIN DIA: .7480 Offset	9128 STD. .5mm .75mm 1.0mm	2-1.5mm 1-4.0mm	12011B03G2	
L4-97.5 1597cc 2.9921(IN) 76.0(MM) NISSAN ENGINE	1987-93		Hypereutectic. E16 engine. Spherical head recess .314" deep. Turbo COMP HT: 1.279 PIN DIA: .7480 Offset	9127H STD. .5mm .75mm 1.0mm	2-1.5mm 1-4.0mm	12011B19G0	
L4-97.5 1597cc 2.9921(IN) 76.0(MM) NISSAN ENGINE	1989-94 9.5		GA16DE engine. DOHC & F.I. 2.550" dia. head recess .190" deep. Full floating pin. COMP HT: 1.140 PIN DIA: .7480 Offset	9126 STD. .5mm .75mm 1.0mm	2-1.5mm 1-2.8mm	A2010-57Y00	
L4-97.6 1600cc 3.0709(IN) 78.0(MM) NISSAN ENGINE	1970-78		Flat head. For Export. From Factory only. COMP HT: 1.566 PIN DIA: .8267 Offset	9079 STD. .5mm .75mm 1.0mm 1.5mm	2-2.0mm 1-4.0mm	12011E3001	

NISSAN

CYL BORE ENGINE	YEAR COMP. RATIO	VIN CODE	NOTES	PART NO. SIZE	RINGS	O.E. ASSY. NO. INTERCHANGE	HEAD SHAPE
L4-110 1800cc 3.1693(IN) 80.5(MM) NISSAN ENGINE	1981-93		J18 engine. Flat head. COMP HT: 1.279 PIN DIA: .8270 Offset	9129 STD. .5mm .75mm 1.0mm	1-1.5mm 1-2.0mm 1-4.0mm	12011J22G0	
L4-119 1952cc 3.3465(IN) 85.0(MM) NISSAN ENGINE	1974-79 8.5		L20 engine. 2.910" dia. head recess .100" deep. COMP HT: 1.482 PIN DIA: .8267 Offset	9048 STD. .5mm .75mm 1.0mm 1.5mm	2-2.0mm 1-4.0mm	12010-U6001	
L4-119 1952cc 3.3465(IN) 85.0(MM) NISSAN ENGINE	1977-80		L20B engine. 2.920" dia. head recess .175" deep. COMP HT: 1.482 PIN DIA: .8267 Offset	9071 STD. .5mm .75mm 1.0mm 1.5mm	2-2.0mm 1-4.0mm		
L4-121 1982cc 3.2677(IN) 83.0(MM) NISSAN ENGINE	1967-70		U20 engine. 2.750" dia. head recess .055" deep. COMP HT: 1.480 PIN DIA: .8267 Offset	9044 STD. .5mm .75mm 1.0mm 1.5mm	2-2.0mm 1-4.0mm	12010-23002 FM 12114NP	
L6-146 2393cc 3.2677(IN) 83.0(MM) NISSAN ENGINE	1970-73 9.0		240Z with L24 engine. Flat head w/2 valve reliefs. COMP HT: 1.515 PIN DIA: .8267 Offset	9045 STD. .5mm .75mm 1.0mm 1.5mm	2-2.0mm 1-4.0mm	12010-H2711	
L4-146 2389cc 3.5039(IN) 89.0(MM) NISSAN ENGINE	1983-90 8.3		Z24 & Z24I Engine. 3.030" dia. head recess .170" deep w/4 valve reliefs. Use late style ring set. COMP HT: 1.327 PIN DIA: .8267 offset	9114 STD. .5mm .75mm 1.0mm	1-2.0mm 1-1.5mm 1-4.0mm	12010-30W01 FM 13013P	
L4-146 2389cc 3.5039(IN) 89.0(MM) NISSAN ENGINE	1989-97 8.3		KA24E engine. SOHC. 3.110" dia. head recess .025" deep. Full floating pin. Lockrings included. For car application. COMP HT: 1.327 PIN DIA: .8267 offset	9115 STD. .5mm .75mm 1.0mm	2-1.5mm 1-2.8mm	A2010-30R10 FM 13503P	
L4-146 2389cc 3.5039(IN) 89.0(MM) NISSAN ENGINE	1989-97 8.3		KA24E engine. SOHC. 3.110" dia. head recess .025" deep. Press fit pin. For truck application. COMP HT: 1.327 PIN DIA: .8267 offset	9116 STD. .5mm .75mm 1.0mm	2-1.5mm 1-2.8mm	12010-86G20	

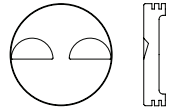
NISSAN

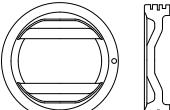
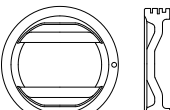
CYL BORE ENGINE	YEAR COMP. RATIO	VIN CODE	NOTES	PART NO. SIZE	RINGS	O.E. ASSY. NO. INTERCHANGE	HEAD SHAPE
L6-156 2565cc 3.2677(IN) 83.0(MM) NISSAN ENGINE	1974-75 8.8		260Z with L26 engine. Flat head w/2 valve reliefs. COMP HT: 1.515 PIN DIA: .8267 Offset	9045 STD. .5mm .75mm 1.0mm 1.5mm	2-2.0mm 1-4.0mm	12010-H2711	
V6-180.5 2960cc 3.4252(IN) 87.0(MM) NISSAN ENGINE	1984-94	H	VG30E engine. Flat head w/2 valve reliefs. Non-turbo. Use late style rings. COMP HT: 1.250 PIN DIA: .8259 Offset	9075 STD. .5mm .75mm 1.0mm	2-1.5mm 1-2.8mm Shallow Groove	12010-21P61-2-3 12010-V8061 FM 12490P FM H832CP	
V6-201 3.3L 3.6024(IN) 91.5(MM) NISSAN ENGINE	1996-06 8.9:1	T	Hypereutectic, Dish ANODIZED CROWN AND TOP RING GROOVE contoured 3.150" dia .079" deep Floating Pin "COATED SKIRTS" COMP HT: 1.250 PIN DIA: .826 Offset	9137HCA STD. .5mm .75mm 1.0mm	1.5mm 1.5mm 2.8mm	A2010-5S701 U-1 / 4	
V8-342 5.6L 3.8583 (IN) 98 (MM) NISSAN ENGINE	2003-10		Hypereutectic ANODIZED CROWN AND TOP RING GROOVE Dish - 3.163" Dia, .165" Deep Titan Floating Pin with "Coated Skirts" COMP HT: 1.230 PIN DIA: .866 Offset	9140HCA STD. .25mm .5mm .75mm 1.0mm	1.5mm 1.5mm 2.5mm	12010-7S000 24733E	

ROVER

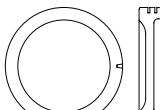
V8-215 3.5L 3.5000(IN) 88.9(MM) BUICK ENGINE	1987-88 8.8		2.812" dia. head recess .150" deep. COMP HT: 1.843 PIN DIA: .8750 Center	1718 STD. .020 .030 .040 .060	2-5/64, 1-3/16	1389184 1399081 FM 71P	
---	--------------------	--	---	---	-------------------	----------------------------------	---

SUBARU

CYL BORE ENGINE	YEAR COMP. RATIO	VIN CODE	NOTES	PART NO. SIZE	RINGS	O.E. ASSY. NO. INTERCHANGE	HEAD SHAPE
NEW H4-151 2.5L 3.917 99.5(MM) SUBARU ENGINE	1999-05	6	Upgraded piston with coated skirts and ANODIZED TOP RING AND CROWN. SOHC 10:1 Floating Pin COMP HT: 1.161 PIN DIA: .906 Offset	9143HCA STD. .25mm .50mm .75mm 1.0mm	1-1.2mm 1-1.2mm 1-2.0mm	12006AB510 12006AC470 1200AC070	
NEW H4-151 2.5L 3.917 99.5(MM) SUBARU ENGINE	2006-10	6	Upgraded piston with coated skirts and ANODIZED TOP RING AND CROWN. SOHC 10:1 Floating Pin Power Improved Dome COMP HT: 1.209 PIN DIA: .906 Offset	9144HCA STD. .25mm .50mm .75mm 1.0mm	1-1.2mm 1-1.2mm 1-2.0mm	12013AB250R 12018AB250L	
NEW H4-151 2.5 L 3.9170(IN) 99.5(MM) SUBARU ENGINE	2006-11 10	3	Hypereutectic dish. Anodized head and top ring groove. SOHC 10:1 EJ253 Factory Dome Shape COMP HT: 1.200 PIN DIA: .906 Offset	9145HCA STD. .25mm .50mm .75mm 1.0mm	1-1.2mm 1-1.2mm 1-2.0mm		

SUZUKI

L3-61 993cc 2.9134(IN) 74.0(MM) SUZUKI ENGINE	1989-94 9.5	6 2	G10 Engine. Offset head recess .070" deep w/2 valve reliefs. 3 ring piston. COMP HT: 1.115 PIN DIA: .6695 Offset	3415 STD. .5mm .75mm 1.0mm	1-1.2mm 1-1.5mm 1-2.8mm 3 RING PISTON	12100-61820-0A0 FM 13509P	
L4-79 1.3L 2.9134(IN) 74.0(MM) SUZUKI ENGINE	1992-02 9.5		SY413 Engine. Offset head recess .070" deep w/2 valve reliefs. 3 ring piston. COMP HT: 1.115 PIN DIA: .6695 Offset	3542 STD. .5mm .75mm 1.0mm	1-1.2mm 1-1.5mm 1-2.8mm 3 RING PISTON		
L4-97.6 1599cc 2.9528(IN) 75.0(MM) SUZUKI ENGINE	1989-95 8.9	U 6	Hypereutectic. G16KC engine. 2.346" dia. head recess .120" deep w/2 valve reliefs. Not intended for Racing applications. COMP HT: 1.103 PIN DIA: .7480 Offset	3414H STD. .5mm .75mm 1.0mm	1-1.2mm 1-1.5mm 1-2.8mm	12111-60A02-0A0 FM H586P	

CYL BORE ENGINE	YEAR COMP. RATIO	VIN CODE	NOTES	PART NO. SIZE	RINGS	O.E. ASSY. NO. INTERCHANGE	HEAD SHAPE
L4-89 1456cc 2.8740(IN) 73.0(MM) TOYOTA ENGINE	1987-94 9.3		3E & 3EE engine. SOHC Head recess .120" deep w/2 valve reliefs. F.I. and Carb. COMP HT: 1.161 PIN DIA: .7090 Offset	9124 STD. .5mm .75mm 1.0mm	2-1.5mm 1-3.0mm	13101-11081-02 FM 12895P	
L4-97.5 1587cc 3.1890(IN) 81.0(MM) TOYOTA ENGINE	1988-93 9.5		4AF & 4AFE engine. DOHC. Head recess .111" deep. COMP HT: 1.185 PIN DIA: .7090 Offset	9117 STD. .5mm .75mm 1.0mm	2-1.5mm 1-3.0mm	13101-16090-02 FM 12764P	
L4-97.6 1587cc 3.1890(IN) 81.0(MM) TOYOTA ENGINE	1983-88 9.0		4ALC engine. Heart shaped head recess .129" deep. COMP HT: 1.193 PIN DIA: .7090 Offset	9066 STD. .5mm .75mm 1.0mm	2-1.5mm 1-2.8mm	13101-16010-02 94840037 FM 12324P	
L4-97.6 1.6L 3.1890(IN) 81.0(MM) TOYOTA ENGINE	1993-97 9.5		4AFE DOHC engine. 2.680" dia. head recess .100" deep w/4 valve reliefs. COMP HT: 1.190 PIN DIA: .7875 Offset	9109 STD. .5mm .75mm 1.0mm	1-1.2mm 1-1.5mm 1-3.0mm	13101-16160-01	
L4-110 1.8L 3.1890(IN) 81.0(MM) TOYOTA ENGINE	1993-97 9.5		7AFE engine. DOHC. 2.650" dia. head recess .130" deep w/4 valve reliefs. COMP HT: 1.190 PIN DIA: .7875 Offset	9107 STD. .5mm .25mm .75mm 1.0mm	1-1.2mm 1-1.5mm 1-3.0mm	13101-16150-01 FM 13504P	
L4-133.6 2189cc 3.4842(IN) 88.5(MM) TOYOTA ENGINE	1975-80 8.4		2OR engine. Dome head .110" high. COMP HT: 1.510 PIN DIA: .8665 Offset	9049 STD. .5mm .75mm 1.0mm 1.5mm	1-2.0mm 1-2.5mm 1-4.0mm	13101-38020 13103-38020 FM 12175P	
L4-136 2237cc 3.5827(IN) 91.0(MM) TOYOTA ENGINE	1986-90 8.8	Y	4YEC engine. Head recess .240" deep. COMP HT: 1.368 PIN DIA: .8665 Offset	9068 STD. .5mm .75mm 1.0mm	2-1.5mm 1-4.0mm	13101-73030 13101-73031-01 13101-73031-02 13101-73031-03	
L4-144 2367cc 3.6220(IN) 92.0(MM) TOYOTA ENGINE	1981-84 9.0		22R engine. Dome head .254" high w/2.300" dia. head recess .200" deep. COMP HT: 1.526 PIN DIA: .8665 Offset	9053 STD. .5mm .75mm 1.0mm 1.5mm	1-2.0mm 1-2.5mm 1-4.0mm	13101-35010 13101-35020 FM 12326P	

TOYOTA

CYL BORE ENGINE	YEAR COMP. RATIO	VIN CODE	NOTES	PART NO. SIZE	RINGS	O.E. ASSY. NO. INTERCHANGE	HEAD SHAPE
L4-144 2367cc 3.6220(IN) 92.0(MM) TOYOTA ENGINE	1981-84 9.0		Hypereutectic. 22R engine. Dome head .254" high w/2.300" dia. head recess .200" deep. COMP HT: 1.536 PIN DIA: .8665 Offset	9059H STD. .5mm .75mm 1.0mm 1.5mm	1-2.0mm 1-2.5mm 1-4.0mm	13101-35010 13101-35020 FM 12326P	
L4-144 2367cc 3.6220(IN) 92.0(MM) TOYOTA ENGINE	1985-94 9.3		22R, 22RE, 22REC engine. 2.500" dia. head recess .070" deep w/2 valve reliefs. COMP HT: 1.355 PIN DIA: .8665 Offset	9070 STD. .5mm .75mm 1.0mm 1.5mm	2-1.5mm 1-4.0mm	13101-35032-01 13101-35032-02 FM 12886P	
L4-144 2367cc 3.6220(IN) 92.0(MM) TOYOTA ENGINE	1985-94 7.5		22RTEC engine. 2.900" dia. head recess .218" deep w/2 valve reliefs. Turbo COMP HT: 1.355 PIN DIA: .8665 Offset	9113 STD. .5mm .75mm 1.0mm	2-1.5mm 1-4.0mm	13101-35032-02	
V6-153 2507cc 3.4449(IN) 87.5(MM) TOYOTA ENGINE	1989-91 9.0		Hypereutectic. 2VZFE engine. DOHC. Head recess .090" deep w/4 valve reliefs. Full floating pin. Not intended for Racing applications. COMP HT: 1.260 PIN DIA: .8270 Offset	9122H STD. .5mm .75mm 1.0mm	2-1.5mm 1-3.0mm	13101-62020	
L6-168 2759cc 3.2677(IN) 83.0(MM) TOYOTA ENGINE	1982-90 8.8		5MGE engine. Dome head .143" high w/2 valve reliefs. Full floating pin. COMP HT: 1.280 PIN DIA: .8665 Offset	9074 STD. .5mm .75mm 1.0mm 1.5mm	2-1.5mm 1-4.0mm	13101-43041-02 13101-43051-02 FM 12963P	
L6-180 2954cc 3.2677(IN) 83.0(MM) TOYOTA ENGINE	1986-93 9.0		7MGE engine. Head recess .120" deep w/4 valve reliefs. COMP HT: 1.280 PIN DIA: .8665 Offset	9088 STD. .5mm .75mm 1.0mm 1.5mm	2-1.5mm 1-4.0mm	13101-42070-02	
V6-180 2959cc 3.4449(IN) 87.5(MM) TOYOTA ENGINE	1987-92 9.0		3VZE engine. Head recess .147" deep w/2 valve reliefs. COMP HT: 1.328 PIN DIA: .8271 Centered	9069 STD. .5mm .75mm 1.0mm	2-1.5mm 1-4.0mm	13101-65030-02 13101-65030-03 13101-65010 FM 613519P	
V6-180 2958cc 3.4449(IN) 87.5(MM) TOYOTA ENGINE	1992-93 9.6		Hypereutectic. 3VZFE engine. DOHC. Head recess .130" deep w/4 valve reliefs. Full floating pin. Not intended for Racing applications. COMP HT: 1.319 PIN DIA: .8660 Offset	9121H STD. .5mm .75mm 1.0mm	2-1.5mm 1-4.0mm	13101-62040-03	

TRIUMPH

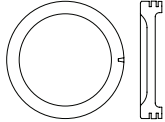
CYL BORE ENGINE	YEAR COMP. RATIO	VIN CODE	NOTES	PART NO. SIZE	RINGS	O.E. ASSY. NO. INTERCHANGE	HEAD SHAPE
V8-215 3.5L 3.5000(IN) 88.9(MM) BUICK ENGINE	1987-88 8.8		2.812" dia. head recess .150" deep. COMP HT: 1.843 PIN DIA: .8750 Center	1718 STD. .020 .030 .040 .060	2-5/64, 1-3/16	1389184 1399081 FM 71P	

VOLKSWAGEN

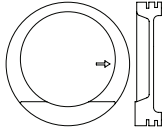
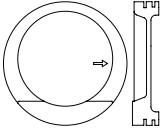
L4-109.8 1.8 L 3.1890(IN) 81.0(MM) VOLKSWAGEN ENGINE	1982-87 to 1993		Step head with 2.350" dia. head recess .360" deep. To 1993 Fox only. Floating Pin. COMP HT: 1.311 PIN DIA: .7874 Offset	9078 STD. .5mm .75mm 1.0mm	1-1.5mm 1-1.75mm 1-3.0mm	026107103Q 027107103O	
L4-109.8 1.8 L 3.1890(IN) 81.0(MM) VOLKSWAGEN ENGINE	1984-89		Step head with 2.430" dia. head recess .360" deep. Floating Pin. COMP HT: 1.311 PIN DIA: .7874 Offset	9077 STD. .5mm .75mm 1.0mm	1-1.5mm 1-1.75mm 1-3.0mm		

NUMERICAL LISTING



Part No.	Division	Cyl	Cu. In.	Liter/cc	Years	Pg.
1000	FORD	L4	200	3.3L	1928-32	30
1058	FORD	V8	239	3.9L	1939-53	32
1066	FORD	V8	312	5.1L	1956-60	40
1072	FORD	V8	292	4.8L	1955-62	36
1079	FORD	L6	223	3.7L	1954-64	31
1106	FORD	V8	260	4.3L	1962-64	35
1116	FORD	V8	390	6.4L	1961-65	44
1119	FORD	L6	170	2.8L	1961-72	29
1120	FORD	L6	200	3.3L	1963-83	30
1120	FORD	L6	250	4.1L	1969-82	34
1129	FORD	V8	352	5.8L	1958-66	42
1130	FORD	V8	390	6.4L	1966-70	44
1131	FORD	V8	360	5.9L	1968-76	42
1131	FORD	V8	390	6.4L	1966-70	44
1131H	FORD	V8	360	5.9L	1968-76	42
1131H	FORD	V8	390	6.4L	1966-70	44
1136	FORD	V8	330	5.4L	1964-78	40
1138	FORD	V8	428	7.0L	1966-70	46
1139	FORD	V8	390	6.4L	1968-76	45
1143	FORD	V8	460	7.5L	1968-87	47
1143HC	FORD	V8	460	7.5L	1968-87	47
1144	FORD	V8	351W	5.8L	1969-71	41
1144HC	FORD	V8	351W	5.8L	1969-71	41
1146	FORD	V8	351C	5.8L	1970	40
1146HC	FORD	V8	351C	5.8	1970	40
1147	FORD	L6	240	3.9L	1969-74	32
1147	FORD	L6	300	4.9L	1975-76	37
1156	FORD	L4	122	2.0L	1971-74	27
1157	FORD	V8	289	4.7L	1964-68	36
1158	FORD	V8	302	5.0L	1968-76	38
1159	FORD	V8	351C	5.8L	1970-74	41
1160	FORD	V8	400	6.6L	1971-82	45
1161	FORD	V8	429	7.0L	1968-73	46
1163	FORD	L4	140	2.3L	1974-89	28
1164	FORD	V6	171	2.8L	1974-75	29
1167	FORD	V8	351M	5.8L	1975-81	41
1168	FORD	L4	109.6	1.8L	1972-80	26
1168	MAZDA	L4	109.6	1797 ^{cc}	1972-80	85
1170	FORD	L6	300	4.9L	1977-86	37
1171	FORD	V8	351W	5.8L	1977-93	41
1171HC	FORD	V8	351W	5.8L	1977-93	41
1173D	FORD	V8	370	6.1L	1979-91	43
1173H	FORD	V8	370	6.1L	1979-91	43
1174	FORD	V6	171	2.8L	76-79,83-85	29
1175D	FORD	V8	429	7.0L	1979-90	46
1176	FORD	V8	255	4.2L	1980-82	34
1177	FORD	V8	289	4.7L	1964-68	36
1177	FORD	V8	302	5.0L	1977-86	38
1177H	FORD	V8	289	4.7	1964-68	36
1177H	FORD	V8	302	5.0	1977-86	38
1177HC	FORD	V8	289	4.7	1964-68	36
1177HC	FORD	V8	302	5.0	1977-86	38

Part No.	Division	Cyl	Cu. In.	Liter/cc	Years	Pg.
1181	FORD	L4	97.6	1.6L	1981-85	26
1182	FORD	L4	122	2.0L	1979-82	27
1182	MAZDA	L4	122	1970 ^{cc}	1979-82	85
1183	FORD	V6	232	3.8L	1982-87	31
1184	FORD	L4	122	2.0L	1982-88	27
1184H	FORD	L4	122	2.0L	1982-88	27
1185	FORD	L4	141	2.3L	1983-94	28
1186	FORD	L6	300	4.9L	1987-96	38
1186H	FORD	L6	300	4.9L	1987-96	38
1190	FORD	L4	116	1.9L	1985-86	26
1191	FORD	L4	116	1.9L	1985-86	26
1192	FORD	L4	153	2.5L	1986-91	29
1193H	FORD	V6	182	3.0L	1986-95	30
1193H	MAZDA	V6	182	3.0L	1986-95	86
1193HC	FORD	V6	182	3.0L	1986-95	30
1193HC	MAZDA	V6	182	3.0L	1986-95	86
1194H	FORD	L4	116	1.9L	1987-90	26
1195	FORD	V8	302	5.0L	1986-94	39
1195C	FORD	V8	302	5.0L	1986-94	39
1197	FORD	L4	140	2.3L	1984-92	28
1199	FORD	V6	177	2.9L	86-92,88-89	29
1250	CHRYSLER	L6	170	2.8L	1960-69	18
1250	CHRYSLER	L6	198	3.2L	1970-74	19
1250	CHRYSLER	L6	225	3.7L	1960-87	20
1263	CHRYSLER	V8	440	7.2L	1966-71	24
1266	AMC/JEEP/EAGLE	V8	318	5.2L	1967-94	12
1266	CHRYSLER	V8	318	5.2L	1967-84	22
1266C	AMC/JEEP/EAGLE	V8	318	5.2L	1967-84	13
1266C	CHRYSLER	V8	318	5.2L	1967-84	22
1267	CHRYSLER	V8	340	5.6L	1968-71	23
1271	CHRYSLER	V8	383	6.3L	1959-71	24
1272D	CHRYSLER	V8	413	6.8L	1960-77	24
1273	CHRYSLER	V8	360	5.9L	1971-81	23
1274	CHRYSLER	V8	400	6.6L	1972-80	24
1276	CHRYSLER	V8	440	7.2L	1972-80	24
1278	CHRYSLER	V8	318	5.2L	1963-78	22
1279	CHRYSLER	V8	360	5.9L	1971-94	23
1279HC	CHRYSLER	V8	360	5.9L	1971-94	23
1280	CHRYSLER	L6	218	3.6L	1942-54	19
1280	CHRYSLER	L6	230	3.8L	1934-60	20
1281	CHRYSLER	L6	237	3.9L	1942-51	21
1281	CHRYSLER	L6	251	4.1L	1942-54	21
1281	CHRYSLER	L6	264	4.3L	1952-60	21
1287	CHRYSLER	L4	135	2.2L	1981-86	15
1288H	CHRYSLER	L4	156	2.6L	1981-89	18
1288H	MITSUBISHI	L4	156	2555 ^{cc}	1984-89	90
1290H	CHRYSLER	L4	135	2.2L	1984-85	16
1291H	CHRYSLER	L4	135	2.2L	1986-90	16
1292	CHRYSLER	L4	153	2.5L	1986-88	17
1293	CHRYSLER	L4	135	2.2L	1986-94	16
1294	CHRYSLER	L6	225	3.7L	1960-87	20
1410	GM	V8	265	4.3L	1955-57	63

Part No.	Division	Cyl	Cu. In.	Liter/cc	Years	Pg.
1412	GM	V8	283	4.6L	1957-70	65
1413	GM	L6	235	3.9L	1941-62	59
1422	GM	L6	261	4.3L	1954-62	61
1423	GM	V8	327	5.4L	1962-69	69
1429	GM	L6	292	4.8L	1963-89	65
1433	GM	V8	396	6.5L	1965-69	74
1434	GM	V8	427	7.0L	1966-69	75
1435D	GM	V8	366	6.0L	1966-85	73
1436	GM	V8	350	5.7L	1969-70	69
1436C	GM	V8	350	5.7L	1969-70	69
1437	GM	L6	292	4.8L	1963-84	65
1438	GM	V8	307	5.0L	1968-73	67
1440D	GM	V8	427	7.0L	1968-84	76
1441	GM	V8	350	5.7L	1969-83	70
1442	GM	V8	350	5.7L	1969-78	70
1443	GM	V8	400	6.6L	1970-80	75
1443HC	GM	V8	400	6.6L	1970-80	75
1445	GM	V8	396	6.5L	1970	74
1445	GM	V8	402	6.6L	1970-72	75
1446	GM	L6	250	4.1L	1966-84	60
1446C	GM	L6	250	4.1L	1966-84	60
1446C	MERCURISER	L6	250	4.1L		87
1448	GM	V8	454	7.4L	1970-83	76
1448H	GM	V8	454	7.4L	1970-83	76
1448HC	GM	V8	454	7.4L	1970-83	76
1449	GM	V8	305	5.0L	1976-86	66
1455	GM	L4	97.6	1.6L	1976-78	48
1456	GM	V6	200	3.3L	1978-79	55
1458	GM	L4	097.6	1.6L	1979-87	48
1461	GM	L4	119	1.9L	1982-85	50
1461	ISUZU	L4	119	1949cc	1982-86	84
1462	GM	L4	110	1.8L	1976-82	49
1462	ISUZU	L4	110	1817cc	1976-82	84
1463	AMC/JEEP/EAGLE	V6	173	2.8L	1982-86	10
1463	GM	V6	173	2.8L	1980-88	53
1463C	AMC/JEEP/EAGLE	V6	173	2.8L	1982-86	10
1463C	GM	V6	173	2.8L	1980-88	53
1467D	GM	V8	379	6.2L	1982-93	74
1468	GM	L4	121	2.0L	1983-84	50
1469	GM	L4	121	2.0L	1985-86	50
1470	GM	V8	350	5.7L	1971-95	71
1472	GM	V8	350	5.7L	1969-90	70
1476H	GM	V8	350	5.7L	1969-90	70
1476HC	GM	V8	350	5.7L	1969-90	70
1476HC	MERCURISER	V8	350	5.7L		88
1478	GM	V6	173	2.8L	1985-93	53
1478	ISUZU	V6	173	2835cc	1985-93	84
1478C	GM	V6	173	2.8L	1985-93	54
1478C	ISUZU	V6	173	2.8L	1985-93	85
1479H	GM	V8	350	5.7L	1969-90	70
1481	GM	L4	121	2.0L	1987-89	50
1482	GM	V8	265	4.3L	1994-96	63

Part No.	Division	Cyl	Cu. In.	Liter/cc	Years	Pg.
1482	GM	V8	305	5.0L	1982-86	66
1482H	GM	V8	265	4.3L	1994-96	63
1482H	GM	V8	305	5.0L	1982-86	66
1482HC	GM	V8	265	4.3L	1994-96	63
1482HC	GM	V8	305	5.0L	1982-86	67
1486	GM	V6	191	3.1L	1990-95	55
1486	ISUZU	V6	191	3130cc	1990-94	85
1486HC	GM	V6	191	3.1L	1990-95	55
1486HC	ISUZU	V6	191	3130cc	1990-94	85
1487	GM	V8	350	5.7L	1986-96	71
1488	GM	L4	134	2.2L	1990-94	51
1489H	GM	V8	350	5.7L	1990-97	71
1489HC	GM	V8	350	5.7L	1990-97	71
1490D	GM	V8	366	6.0L	1985-90	73
1491H	MERCURISER	L4	181	3.0L	1982-89	87
1492	GM	V6	173	2.8L	1988-89	54
1492C	GM	V6	173	2.8L	1988-89	54
1493	GM	V8	305	5.0L	1987-95	67
1493C	GM	V8	305	5.0L	1987-95	67
1493C	MERCURISER	V8	305	5.0L		87
1496	GM	V6	191	3.1L	1988-95	54
1496HC	GM	V6	191	3.1L	1988-95	54
1516	PONTIAC	V8	389	6.4	1959-66	74
1520	GM	V8	350	5.7L	1968-77	72
1525	GM	V8	455	7.5L	1970-76	78
1526	GM	V8	400	6.6L	1967-79	75
1527	GM	V8	301	4.9L	1977-81	66
1528	AMC/JEEP/EAGLE	L4	151	2.5L	1980-83	9
1528	GM	L4	151	2.5L	1979-86	52
1528HC	AMC/JEEP/EAGLE	L4	151	2.5L	1980-83	9
1528HC	GM	L4	151	2.5L	1979-86	52
1531	GM	V8	301	4.9L	1980-81	66
1532	AMC/JEEP/EAGLE	L4	151	2.5L	1981-83	10
1532	GM	L4	151	2.5L	1982-86	53
1533H	AMC/JEEP/EAGLE	L4	151	2.5L	1979-93	9
1533H	GM	L4	151	2.5L	1979-93	53
1533HC	AMC/JEEP/EAGLE	L4	151	2.5L	1979-93	9
1533HC	GM	L4	151	2.5L	1979-93	53
1536H	GM	L4	121	2.0L	1987-91	50
1537H	GM	L4	121	2.0L	1992-94	51
1537HC	GM	L4	121	2.0L	1992-94	51
1538H	GM	L4	121	2.0L	1987-90	50
1539	GM	L4	151	2.5L	1977-78	52
1540HC	GM	L4	151	2.5L	1979-86	52
1630	GM	V8	455	7.5L	1968-76	77
1631	GM	V8	455	7.5L	1968-76	77
1633	GM	V8	350	5.7L	1968-80	72
1634	GM	V8	260	4.3L	1972-83	61
1635	GM	V8	403	6.6L	1977-79	75
1636	GM	V8	307	5.0L	1980-84	67
1637D	OLDSMOBILE	V8	350	5.7L	1978-85	72
1639	GM	V8	307	5.0L	1985-90	68

NUMERICAL LISTING



Part No.	Division	Cyl	Cu. In.	Liter/cc	Years	Pg.
1639HC	GM	V8	307	5.0L	1985-90	68
1642H	GM	L4	138	2.3L	1988-94	52
1717	GM	V8	401	6.6L	1959-66	75
1718	GM	V8	215	3.5L	1961-63	57
1718	ROVER	V8	215	3.5L	1987-88	93
1718	TRIUMPH	V8	215	3.5L	1987-88	97
1724	GM	V8	300	4.9L	1964-67	66
1724	GM	V8	340	5.6L	1966-67	69
1728	GM	V8	430	7.0L	1967-69	76
1730	GM	V8	455	7.5L	1970-76	77
1730H	GM	V8	455	7.5L	1970-76	77
1731	GM	V6	231	3.8L	1975-87	58
1732H	GM	V6	252	4.1L	1980-84	60
1732HC	GM	V6	252	4.1L	1980-84	61
1734	GM	V6	181	3.0L	1982-87	54
1735H	GM	V6	231	3.8L	1978-87	58
1735HC	GM	V6	231	3.8L	1978-87	58
1736	GM	V6	181	3.0L	1985-88	54
1738H	GM	V6	231	3.8L	1988-93	58
1738H	HOLDEN	V6	231	3.8L	1988-93	79
1738HC	GM	V6	231	3.8L	1988-93	59
1740H	GM	V6	231	3.8L	1975-87	58
1743H	GM	V6	204	3.3L	1989-93	55
1744H	GM	V6	231	3.8L	1993-95	59
1745H	GM	V6	231	3.8L	1995-01	59
1745HC	GM	V6	231	3.8L	1995-01	59
1746	AMC/JEEP/EAGLE	V8	350	5.7L	1968-71	13
1746	GM	V8	350	5.7L	1968-81	69
1747H	GM	V6	232	3.8L	1996-01	59
1747HC	GM	V6	232	3.8L	1996-01	59
1748	AMC/JEEP/EAGLE	V6	225	3.7L	1966-71	10
1748	GM	V6	225	3.7L	1964-67	57
1749H	GM	V8	350	5.7L	1968-81	69
1750HC	GM	V6	231	3.8L	1992-94	59
1751H	BUICK/HOLDEN	V6	231	3.8		80
1752H	BUICK/HOLDEN	V6	231	3.8		80
1753H	BUICK/HOLDEN	V6	231	3.8		80
1754HC	BUICK/HOLDEN	V6	231	3.8		80
1755H	BUICK/HOLDEN	V6	231	3.8		80
1756H	HOLDEN	L6	202	3.3		79
1757H	HOLDEN	V8	253	4.1		80
1758HC	BUICK/HOLDEN	L6	220	3.6		79
1759H	BUICK/HOLDEN	V8	308	5.0		81
1760H	BUICK/HOLDEN	V8	299	4.9		81
1761H	BUICK/HOLDEN	V8	308	5.0		81
1762H	BUICK/HOLDEN	L6	202	3.3		79
1763H	BUICK/HOLDEN	L6	202	3.3		79
1764H	BUICK/HOLDEN	V8	299	4.9		80
1765HC	BUICK/HOLDEN	L6	220	3.6		79
1766HC	HOLDEN	V6	195	3.2	2006-Present	79
1767HC	HOLDEN	V8	253	4.1	1968-86	80
1768H	HOLDEN	L6	186	3.0		78

Part No.	Division	Cyl	Cu. In.	Liter/cc	Years	Pg.
1769H	HOLDEN	V6	186	3.0		79
1814	GM	V8	472	7.7L	1968-74	78
1815	GM	V8	500	8.2L	1970-73	78
1817	GM	V8	500	8.2L	1974-76	78
1818	GM	V8	425	7.0L	1977-79	75
1820	GM	V8	250	4.1L	1982-87	60
1822	GM	V8	273	4.5L	1990-94	64
1822	GM	V8	298	4.9L	1991-94	66
1823	GM	V8	273	4.5L	1987-89	64
1825	GM	V6	181	3.0L	1997-01	54
1826H	GM	V8	281	4.6L	1993-96	64
1826HC	GM	V8	281	4.6L	1993-96	64
1900HC	GM	L4	116	1.9L	1991-98	49
1901HC	GM	L4	116	1.9L	1991-93	49
1902HC	GM	L4	116	1.9L	1994-98	50
1903HC	GM	L4	116	1.9L	1999-02	50
2103	AMC/JEEP/EAGLE	L6	226	3.7L	1946-65	11
2103	CONTINENTAL	L6	226	3.7L	1946-65	25
2225	AMC/JEEP/EAGLE	V8	360	5.9L	1970-91	13
2225C	AMC/JEEP/EAGLE	V8	360	5.9L	1970-91	13
2226	AMC/JEEP/EAGLE	L6	232	3.8L	1965-79	11
2226	IHC/ NAVISTAR	L6	232	3.8L		82
2226	AMC/JEEP/EAGLE	L6	258	4.2L	1971-78	12
2226	IHC/ NAVISTAR	L6	258	4.2L		82
2227	AMC/JEEP/EAGLE	L6	258	4.2L	1979-90	12
2228	AMC/JEEP/EAGLE	L4	151	2.5L	1983-95	9
2228	CHRYSLER	L4	151	2.5L	1983-95	17
2228C	AMC/JEEP/EAGLE	L4	151	2.5L	1983-95	9
2228C	CHRYSLER	L4	151	2.5L	1983-95	17
2229	AMC/JEEP/EAGLE	L6	242	4.0L	1987-95	11
2229C	AMC/JEEP/EAGLE	L6	242	4.0L	1987-95	12
2234	AMC/JEEP/EAGLE	V8	304	5.0L	1970-79	12
2606	AMC/JEEP/EAGLE	L4	134	2.2L	1941-71	8
3100	FORD	L4	134	2.2L	1988-92	27
3100	MAZDA	L4	134	2184cc	1987-92	86
3101HC	FORD	V8	289	4.7L	1964-68	36
3101HC	FORD	V8	302	5.0L	1968-92	38
3109	FORD	V8	460	7.5L	1988-93	47
3109H	FORD	V8	460	7.5L	1988-93	47
3109HC	FORD	V8	460	7.5L	1988-93	47
3117H	FORD	L6	300	4.9L	1969-92	37
3118H	FORD	L6	300	4.9L	1969-92	37
3119	FORD	L4	116	1.9L	1987-96	26
3119H	FORD	L4	116	1.9L	1987-96	26
3121H	FORD	L4	134	2.2L	1988-92	28
3121H	MAZDA	L4	134	2184cc	1988-92	86
3124H	FORD	L4	140	2.3L	79-82,89-95	28
3126	FORD	L4	079	1.3L	1988-95	26
3128H	FORD	V6	232	3.8L	1988-95	31
3128HC	FORD	V6	232	3.8L	1988-95	31
3133H	FORD	V8	302	5.0L	1987-95	39
3133HC	FORD	V8	302	5.0L	1987-95	39

Part No.	Division	Cyl	Cu. In.	Liter/cc	Years	Pg.
3135H	FORD	V8	281	4.6L	1990-97	35
3135HC	FORD	V8	281	4.6L	1990-97	35
3136	FORD	L6	300	4.9L	1969-87	37
3141D	FORD	L6	300	4.9L	1969-87	37
3144D	FORD	V8	361	5.9L	1964-78	43
3145D	FORD	V8	389	6.4L	1964-78	44
3145D	FORD	V8	391	6.4L	1975-78	45
3150H	FORD	V8	429	7.0L	1993-98	46
3150HC	FORD	V8	429	7.0L	1993-98	47
3151H	FORD	V6	244	4.0L	1995-98	33
3151H	MAZDA	V6	244	4.0L	1995-97	86
3152H	FORD	V6	256	4.2L	1996-02	34
3152HC	FORD	V6	256	4.2L	1996-02	35
3154H	FORD	V8	351W	5.8L	1994-97	42
3155HC	FORD	V6	244	4.0L	1997-02	33
3156H	FORD	V6	244	4.0L	1990-94	33
3156HC	FORD	V6	244	4.0L	1990-94	33
3157H	FORD	V8	460	7.5L	1993-97	47
3157HC	FORD	V8	460	7.5L	1993-97	48
3158H	FORD	L6	300	4.9L	1969-79	37
3158HC	FORD	L6	300	4.9L	1969-79	37
3159H	FORD	V6	232	3.8L	1996-02	32
3159HC	FORD	V6	232	3.8L	1996-02	32
3160HC	FORD	V8	330	5.4L	1997-04	40
3161HC	FORD	V10	415	6.8L	1997-01	45
3162H	FORD	L4	122	2.0L	1995-97	27
3163	FORD	V8	335	5.5L	1969-95	40
3164H	MERCURISER	L4	224	3.7L		87
3165H	FORD	V8	302	5.0L	1987-95	39
3165HC	FORD	V8	302	5.0L	1987-95	39
3166H	FORD	V8	351W	5.8L	1994-97	42
3166HC	FORD	V8	351W	5.8L	1994-97	42
3167H	FORD	L4	122	2.0L	1997-02	27
3167HC	FORD	L4	122	2.0L	1997-02	27
3168	FORD	L4	152	2.5L	1998-01	28
3168H	FORD	L4	152	2.5L	1998-01	28
3168HC	FORD	L4	152	2.5L	1998-01	29
3169	FORD	V8	302	5.0L	1986-91	39
3170HC	FORD	V8	429	7.0L	1979-92	46
3171H	FORD	L6	300	4.9L	1996-97	38
3172HC	FORD	V8	370	6.1L	1979-92	43
3173HC	FORD	V8	302	5.0L	1996-00	39
3174HC	FORD	V8	281	4.6L	1991-00	35
3175HC	FORD	V8	281	4.6L	2001-03	35
3176H	FORD	V8	359	5.9L	1973-78	42
3176H	FORD	V8	361	5.9L	1964-78	43
3177H	FORD	V8	389	6.4L	1975-78	44
3177H	FORD	V8	391	6.4L	1964-78	45
3179HC	FORD	V8	281	4.6L	1993-97	35
3180HC	FORD	V8	281	4.6L	1997-01	35
3181H	FORD	V6	232	3.8L	1989-95	32
3181HC	FORD	V6	232	3.8L	1989-95	32

Part No.	Division	Cyl	Cu. In.	Liter/cc	Years	Pg.
3182HC	FORD	V6	181	3.0L	1996-03	86
3183HC	FORD	V6	155	2.5L	1998-00	29
3184HC	FORD	V6	155	2.5L	1995-99	29
3185H	FORD	L4	140	2.3L	1995-97	28
3186	FORD	V8	256	4.2L	1954-55	34
3187	FORD	V8	221	3.6L	1962-63	31
3188	FORD	L6	240	3.9L	1966-68	32
3189H	FORD	V8	429	7.0L	1979-92	46
3189HC	FORD	V8	429	7.0L	1979-92	46
3190HC	FORD	V8	330	5.4L	1997-05	40
3191H	MERCURISER	V8	460	7.5L		89
3191HC	MERCURISER	V8	460	7.5L		89
3192H	FORD	V8	360	5.9L	1968-76	43
3192H	FORD	V8	390	6.4L	1966-70	44
3193	FORD	V8	390	6.4L	1968-76	45
3194H	FORD	V8	359	5.9L	1973-78	42
3194H	FORD	V8	361	5.9L	1964-78	43
3195H	FORD	V8	389	6.4L	1975-78	44
3195H	FORD	V8	391	6.4L	1964-78	45
3196HC	FORD	V10	415	6.8L	1997-05	45
3197HC	FORD	V6	183	3.0L	1999-05	30
3201	CHRYSLER	V6	181	3.0L	1987-93	18
3201	HYUNDAI	V6	181	2972cc	1989-92	82
3201	MITSUBISHI	V6	181	2972cc	1988-93	90
3201HC	CHRYSLER	V6	181	3.0L	1987-93	18
3201HC	HYUNDAI	V6	181	2972cc	1990	82
3201HC	MITSUBISHI	V6	181	2972cc	1989-90	91
3209	CHRYSLER	V6	230	3.8L	1991-99	20
3209C	CHRYSLER	V6	230	3.8L	1991-99	20
3210H	CHRYSLER	L4	156	2.6L	76-87,84-89	18
3210H	MITSUBISHI	L4	156	2555cc	1983-89	90
3211	CHRYSLER	L4	153	2.5L	1989-95	17
3211C	CHRYSLER	L4	153	2.5L	1989-95	17
3212	AMC/JEEP/EAGLE	V6	201	3.3L	1990-94	10
3212	CHRYSLER	V6	201	3.3L	1990-97	19
3212C	AMC/JEEP/EAGLE	V6	201	3.3L	1990-94	10
3212C	CHRYSLER	V6	201	3.3L	1990-97	19
3213H	AMC/JEEP/EAGLE	L4	090	1.5L	1991-95	8
3213H	CHRYSLER	L4	090	1.5L	1991-95	15
3213H	MITSUBISHI	L4	090	1.5L	1990-93	89
3214HC	AMC/JEEP/EAGLE	V6	213	3.5L	1993-97	10
3214HC	CHRYSLER	V6	213	3.5L	1993-97	19
3215	AMC/JEEP/EAGLE	V6	181	3.0L	1988-92	10
3215	CHRYSLER	V6	181	3.0L	1988-92	18
3216	AMC/JEEP/EAGLE	L4	110	1.8L	1989-94	8
3216	CHRYSLER	L4	110	1.8L	1989-94	15
3216	MITSUBISHI	L4	110	1755cc	1989-94	89
3217	CHRYSLER	L4	122	2.0L	1983-92	15
3217	MITSUBISHI	L4	122	1997cc	1983-92	90
3219D	CHRYSLER	V8	361	5.9L	1960-77	24
3220	AMC/JEEP/EAGLE	L4	110	1.8L	1990-94	8
3220	CHRYSLER	L4	110	1.8L	1990-94	15

NUMERICAL LISTING



Part No.	Division	Cyl	Cu. In.	Liter/cc	Years	Pg.
3220	MITSUBISHI	L4	110	1834cc	1990-94	90
3221	AMC/JEEP/EAGLE	L4	143	2.4L	1993-96	8
3221	CHRYSLER	L4	143	2.4L	1993-96	16
3221	MITSUBISHI	L4	143	2351cc	1992-01	90
3222	AMC/JEEP/EAGLE	V8	360	5.9L	1993-01	13
3222	CHRYSLER	V8	360	5.9L	1993-01	23
3222HC	AMC/JEEP/EAGLE	V8	360	5.9L	1993-01	14
3222HC	CHRYSLER	V8	360	5.9L	1993-01	24
3223H	CHRYSLER	L4	153	2.5L	1989-94	17
3224HC	CHRYSLER	V6	181	3.0L	1992-00	18
3224HC	MITSUBISHI	V6	181	2972cc	1993-99	91
3225	AMC/JEEP/EAGLE	L4	143	2.4L	1992-93	8
3225	CHRYSLER	L4	143	2.4L	1989-92	16
3225	MITSUBISHI	L4	143	2351cc	1989-92	90
3228	AMC/JEEP/EAGLE	L4	122	2.0L	1995-99	8
3228	CHRYSLER	L4	122	2.0L	1996-99	15
3228HC	AMC/JEEP/EAGLE	L4	122	2.0L	1995-99	8
3228HC	CHRYSLER	L4	122	2.0L	1996-99	15
3229HC	CHRYSLER	L4	122	2.0L	1995-00	15
3230C	CHRYSLER	V6	201	3.3L	2000-02	19
3233	CHRYSLER	L4	146	2.4L	1998-00	16
3234H	AMC/JEEP/EAGLE	V8	318	5.2L	1985-02	13
3234H	CHRYSLER	V8	318	5.2L	1985-02	22
3234HC	AMC/JEEP/EAGLE	V8	318	5.2L	1985-02	13
3234HC	CHRYSLER	V8	318	5.2L	1985-02	22
3235HC	CHRYSLER	V6	167	2.7L	1998-04	18
3236H	AMC/JEEP/EAGLE	V6	239	3.9L	1986-02	11
3236H	CHRYSLER	V6	239	3.9L	1986-02	21
3236HC	AMC/JEEP/EAGLE	V6	239	3.9L	1986-02	11
3236HC	CHRYSLER	V6	239	3.9L	1986-02	21
3237HC	CHRYSLER	V10	488	8.0L	1994-01	24
3238HC	AMC/JEEP/EAGLE	L4	151	2.5L	1996-02	9
3238HC	CHRYSLER	L4	151	2.5L	1996-02	17
3239HC	CHRYSLER	V6	215	3.5L	1996-97	19
3241HC	AMC/JEEP/EAGLE	L6	242	4.0L	1996-02	12
3242HC	AMC/JEEP/EAGLE	L6	242	4.0L	1996-02	12
3243HC	AMC/JEEP/EAGLE	L4	151	2.5L	1996-02	9
3243HC	CHRYSLER	L4	151	2.5L	1996-02	17
3244	CHRYSLER	V8	323	5.3L	1942-50	22
3245C	CHRYSLER	V6	230	3.8L	2000-03	20
3246	AMC/JEEP/EAGLE	V6	239	3.9L	1986-02	11
3246	CHRYSLER	V6	239	3.9L	1986-02	21
3247	AMC/JEEP/EAGLE	V8	318	5.2L	1985-02	13
3247	CHRYSLER	V8	318	5.2L	1985-02	22
3248HC	CHRYSLER	V8	345	5.7L	2002-06	23
3249HC	CHRYSLER	L4	146	2.4L	2001-06	16
3250HC	CHRYSLER	L4	146	2.4L	2004-06	16
3251HC	AMC/JEEP/EAGLE	V6	226	3.7L	2002-06	11
3251HC	CHRYSLER	V6	226	3.7L	2002-06	20
3252HC	AMC/JEEP/EAGLE	V8	287	4.7L	1999-06	12
3252HC	CHRYSLER	V8	287	4.7L	1999-06	21
3255HC	CHRYSLER	V6	214	3.5	1999-03	19

Part No.	Division	Cyl	Cu. In.	Liter/cc	Years	Pg.
3257HCA	CHRYSLER	V8	345	5.7L	2009-11	23
3258HCA	CHRYSLER	V8	372	6.1L	2009-10	24
3259HC	CHRYSLER	V6	230	3.8L	2007-13	21
3260HCA	CHRYSLER	V8	345	5.7L	2009-11	23
3261HC	CHRYSLER	V8	287	4.7L	2002-04	22
3262HCA	CHRYSLER	V6	218	3.6L	2011-19	20
3322	FORD INDUSTRIAL	L4	79	1.3L	1998-01	25
3323HC	FORD	V8	330	5.4	2006-11	40
3324H	AUS. FORD	L6	241	4.0		33
3325H	AUS. FORD	L6	241	4.0		33
3326H	AUS. FORD	L6	241	4.0		33
3327H	AUS. FORD	L6	200/250	3.2/4.1		34
3328H	AUS. FORD	L6	200/250	3.3/4.1		34
3329H	AUS. FORD	V8	351C	5.8		41
3330	FORD	V8	351W	5.8	1969-76	41
3331H	AUS. FORD	L6	238	3.9	1987	32
3332H	AUS. FORD	L6	250	4.1		34
3333H	AUS. FORD	L6	241	4.0		33
3334HC	AUS. FORD	L6	244	4.0		34
3335HC	FORD	V8	281	4.6	2006-10	36
3336HC	FORD	V6	214	3.5L	2007-10	31
3338HC	FORD	V8	281	4.6L	2014	36
3339HC	FORD	V6	214	3.5L	2007-10	31
3340HCA	FORD	V6	214	3.5L	2010-15	31
3342HCA	FORD	V8	397	6.2L	2010-17	43
3401D	GM	V8	427	7.0L	1984-93	76
3403HC	GM	V8	454	7.4L	1981-90	76
3408H	GM	V8	454	7.4L	1991-98	76
3408HC	GM	V8	454	7.4L	1991-98	77
3409	GM	V6	207	3.4L	1991-95	56
3410H	GM	V8	366	6.0L	1991-93	73
3411H	GM	V6	262	4.3L	1992-96	63
3412	GM	L4	085.5	1.4L		48
3413	GM	V8	327	5.4L	1962-68	68
3414H	GM	L4	097.6	1.6L	1989-95	48
3414H	SUZUKI	L4	097.6	1599cc	1989-95	94
3415	GM	L3	061	1.0L	1989-98	48
3415	SUZUKI	L3	061	993cc	1989-94	94
3420H	GM	V6	207	3.4L	1993-95	56
3422	GM	L4	134	2.2L	1992-97	51
3422H	GM	L4	134	2.2L	1992-97	51
3422HC	GM	L4	134	2.2L	1992-97	51
3436D	GM	V8	395	6.5L	1992-01	74
3437H	GM	V8	350	5.7L	1969-90	70
3437HC	GM	V8	350	5.7L	1969-90	71
3437HC	MERCUISER	V8	350	5.7L		88
3439	GM	V6	207	3.4L	1996-03	56
3439HC	GM	V6	207	3.4L	1996-03	56
3440H	GM	V8	454	7.4L	1996-00	77
3440HC	GM	V8	454	7.4L	1996-00	77
3441	GM	V8	265	4.3L	1996-01	63
3441	GM	V8	305	5.0L	1996-01	67

Part No.	Division	Cyl	Cu. In.	Liter/cc	Years	Pg.
3442H	GM	L4	146	2.4L	1996-98	52
3442HC	GM	L4	146	2.4L	1996-98	52
3443	GM	L4	112	1.8L	1982	49
3443C	GM	L4	112	1.8L	1982	49
3444	GM	V6	229	3.8L	1980-86	57
3445	GM	V6	262	4.3L	1985-95	62
3445C	GM	V6	262	4.3L	1985-95	62
3448D	GM	V8	366	6.0L	1991-93	73
3451H	GM	V6	262	4.3L	1996-07	63
3451HC	GM	V6	262	4.3L	1996-07	63
3452H	MERCruiser	V8	305	5.0L		87
3452HC	MERCruiser	V8	305	5.0L		88
3454	GM	L6	250	4.1L	1966-90	60
3455H	MERCruiser	V6	262	4.3L		87
3456HC	MERCruiser	V8	350	5.7L		88
3457H	MERCruiser	V8	350	5.7L		88
3458H	GM (MERCruiser)	V8	454	7.4L		88
3458HC	GM (MERCruiser)	V8	454	7.4L		89
3459C	GM	V6	191	3.1L	1996-99	55
3459HC	GM	V6	191	3.1L	1996-99	55
3460HC	GM	V6	214	3.5L	1999-02	56
3461HC	GM	V8	366	6.0L	1985-90	73
3462H	GM	V8	350	5.7L	1972-96	71
3462H	MERCruiser	V8	350	5.7L		88
3462HC	GM	V8	350	5.7L	1972-96	71
3462HC	MERCruiser	V8	350	5.7L		88
3463H	GM	V6	262	4.3L	1985-95	62
3463HC	GM	V6	262	4.3L	1985-95	62
3466	GM	V6	229	3.8L	1980-84	57
3467H	GM	V6	229	3.8L	1980-84	57
3468H	GM	L6	292	4.8L	1963-89	65
3468HC	GM	L6	292	4.8L	1963-89	65
3469	GM	V8	244	4.0L	1996-99	60
3470H	GM	V8	350	5.7L	1996-01	72
3470HC	GM	V8	350	5.7L	1996-01	72
3471H	GM	V8	350	5.7L	1992-96	71
3472HC	GM	V8	325	5.3L	1999-03	68
3473HC	GM	V8	364	6.0L	1999-03	72
3474HC	MERCruiser	V8	454	7.4L		89
3475HC	MERCruiser	V8	454	7.4L		89
3476H	GM	V6	262	4.3L	1990-95	62
3476HC	GM	V6	262	4.3L	1990-95	63
3477HC	GM	V6	191	3.1L	1994-96	55
3478HC	GM	L4	134	2.2L	1998-03	51
3479HC	GM	V8	366	6.0L	1991-98	74
3481HC	GM	V8	366	6.0L	1966-85	73
3482HC	GM	V8	293	4.8L	1999-03	65
3483HC	GM	V6	207	3.4L	1991-97	56
3484	GM	V8	244	4.0L	1995	60
3485	GM	L6	230	3.8L	1963-70	58
3486	GM	L4	153	2.5L	1962-70	53
3487	GM	V6	262	4.3L		61

Part No.	Division	Cyl	Cu. In.	Liter/cc	Years	Pg.
3487C	GM	V6	262	4.3L		61
3488	GM	V6	262	4.3L		61
3489	GM	V8	267	4.4L	1979-82	63
3490H	GM	V6	262	4.3L	1985-95	62
3490H	MERCruiser	V6	262	4.3L		87
3490HC	GM	V6	262	4.3L	1985-95	62
3490HC	MERCruiser	V6	262	4.3L		87
3491	GM	V6	262	4.3L	1988-96	62
3492	GM	V6	229	3.8L	1987-94	58
3492C	GM	V6	229	3.8L	1987-94	58
3493HC	MERCruiser	L4	181	3.0L		86
3494HC	GM	V8	496	8.1L	2001-04	78
3494HCA	GM	V8	496	8.1L	2001-04	78
3495HC	GM	L4	134	2.2L	2002-06	51
3496HC	GM	L6	256	4.2L	2002-05	61
3497HC	GM	V8	281	4.6L	2003-05	64
3498HC	GM	V8	346	5.7L	1997-04	69
3499HC	GM	V8	346	5.7L	2004-06	69
3510HC	GM	L5	211	3.5L	2004-05	56
3511HC	GM	L4	171	2.8L	2004-05	53
3512HC	GM	V6	191	3.1L	1999-03	55
3513	GM	V8	305	5.0L		67
3514	GM	V8	305	5.0L		67
3515HC	GM	V8	281	4.6L		64
3516HC	GM	V8	364	6.0L	2003-08	72
3517HC	GM	V8	364	6.0L	2002-06	72
3518HC	GM	V8	364	6.0L	2006-08	73
3519HC	GM	V8	325	5.3L	2004-07	68
3520HC	GM	V8	293	4.8L	2005-08	65
3520HC	GM	V8	325	5.3L	2005-08	68
3523HC	GM	V8	378	6.2L	2008-10	74
3524HC	GM	L6	256	4.2	2006-08	61
3525HC	GM	V6	214	3.5L	2009	56
3526HCA	CHEVY	V8	292	4.8L	2010-14	66
3526HCA	CHEVY	V8	323	5.3L	2010-11	68
3527HCA	CHEVY	V8	364	6.0L	2005-11	73
3530HCA	CHEVY	V8	378	6.2L	2008-09	74
3531HC	CHEVY	V6	238	3.9L	2006-11	60
3532HC	CADILLAC	V8	281	4.6L	2006-Present	65
3536HC	CHEVY	V8	350	5.7L		70
3535HC	GM	V8	325	5.3L	1999-03	68
3537HCA	GM	L4	146	2.4L	2005-15	52
3538HCA	GM	V6	218	3.6L	2007-17	57
3539HCA	GM	V6	218	3.6L	2012-18	57
4501	CONTINENTAL	L4	163	2.6L		25
4537	AMC/JEEP/EAGLE	L6	226	3.7L	1954-65	11
4537	CONTINENTAL	L6	226	3.7L	1954-65	25
4538	CONTINENTAL	L6	245	4.0L		25
7058D	IHC/ NAVISTAR	V8	304	5.0 L		83
7058D	IHC/ NAVISTAR	V8	345	5.6 L		83
7080D	IHC/ NAVISTAR	V8	392	6.4 L		83
7082D	IHC/ NAVISTAR	V8	304	4.9 L		83

NUMERICAL LISTING



Part No.	Division	Cyl	Cu. In.	Liter/cc	Years	Pg.
7082D	IHC/ NAVISTAR	V8	345	5.6 L		83
7084D	IHC/ NAVISTAR	V8	404	6.6 L	1975-80	83
7084D	IHC/ NAVISTAR	V8	446	7.3 L	1975-80	84
7096D	FORD	V8	421	6.9L	1984-87	46
7096D	IHC/ NAVISTAR	V8	421	6.9L	1983-86	83
7098D	FORD	V8	445	7.3L	1989-94	47
7098D	IHC/ NAVISTAR	V8	445	7.3L	1989-94	83
7099D	IHC/ NAVISTAR	V8	551	9.0 L		84
7185D	IHC/ NAVISTAR	L4	152	2.5 L	1965-68	82
7186D	IHC/ NAVISTAR	L4	196	3.2 L	1955-56	82
7187D	IHC/ NAVISTAR	L4	152	2.5 L		82
9044	NISSAN	L4	097.1	1595cc	1969-73	91
9044	NISSAN	L4	121	1982cc	1967-70	92
9045	NISSAN	L6	146	2393cc	1970-73	92
9045	NISSAN	L6	156	2565cc	1974-75	93
9048	NISSAN	L4	119	1952cc	1974-79	92
9049	TOYOTA	L4	133.6	2189cc	1975-80	95
9053	TOYOTA	L4	144	2367cc	1981-84	95
9059H	TOYOTA	L4	144	2367cc	1981-84	96
9066	GM	L4	097.6	1.6L	1983-88	48
9066	TOYOTA	L4	097.6	1587cc	1983-88	95
9068	TOYOTA	L4	136	2237cc	1986-90	95
9069	TOYOTA	V6	180	2959cc	1987-92	96
9070	TOYOTA	L4	144	2367cc	1985-94	96
9071	NISSAN	L4	119	1952cc	1977-80	92
9072	NISSAN	L4	097	1597cc	1983-88	91
9074	TOYOTA	L6	168	2759cc	1982-90	96
9075	NISSAN	V6	180.5	2960cc	1984-94	93
9076H	HONDA	L4	131.5	2156cc	1990-93	81
9077	VOLKSWAGEN	L4	109.8	1.8 L	1984-89	97
9078	VOLKSWAGEN	L4	109.8	1.8 L	82-87 to 93	97
9079	NISSAN	L4	097.6	1600cc	1970-78	91
9082	GM	L4	097.6	1.6L		48
9083	HONDA	L4	091.5	1493cc	1988-91	81
9083HC	HONDA	L4	91.5	1493cc	1988-91	81
9084	ISUZU	L4	140	2254cc	1986-94	84
9085	ISUZU	L4	158.6	2559cc	1988-94	84
9088	TOYOTA	L6	180	2954cc	1986-93	96
9107	GM	L4	110	1.8L	1993-97	49
9107	TOYOTA	L4	110	1.8L	1993-97	95
9109	GM	L4	097.6	1.6L	1992-97	49
9109	TOYOTA	L4	097.6	1.6L	1993-97	95
9113	TOYOTA	L4	144	2367cc	1985-94	96
9114	NISSAN	L4	146	2389cc	1983-90	92
9115	NISSAN	L4	146	2389cc	1989-97	92
9116	NISSAN	L4	146	2389cc	1989-97	92
9117	TOYOTA	L4	097.5	1587cc	1988-93	95
9121H	TOYOTA	V6	180	2958cc	1992-93	96
9122H	TOYOTA	V6	153	2507cc	1989-91	96
9123H	MITSUBISHI	L4	122	1997cc	1989-92	90
9124	TOYOTA	L4	089	1456cc	1987-94	95
9125	MAZDA	L4	122	1998cc	1983-87	85

Part No.	Division	Cyl	Cu. In.	Liter/cc	Years	Pg.
9126	NISSAN	L4	097.5	1597cc	1989-94	91
9127H	NISSAN	L4	097.5	1597cc	1987-93	91
9128	NISSAN	L4	097.5	1597cc	1986-92	91
9129	NISSAN	L4	110	1800cc	1981-93	92
9134HC	MAZDA	L4	122	2.0L	2004-08	85
9137HCA	NISSAN	V6	201	3.3L	1996-06	93
9140HCA	NISSAN	V8	342	5.6L	2003-10	93
9143HCA	SUBARU	H4	151	2.5L	1999-05	94
9144HCA	SUBARU	H4	151	2.5L	2006-10	94
9145HCA	SUBARU	H4	151	2.5L	2006-11	94

1003NP... 1058
 1009P... 1413
 1011P... 1079
 1011P... 3186
 1022NP... 1072
 1031NP... 1066
 1070P... 3136
 1079NP... 2234
 1080P... 4501
 1080P... 4538
 1107NP... 3485
 1108NP... 3486
 1114P... 1527
 12114NP... 9044
 12114NP... 9044
 12175P... 9049
 12215P... 1182
 12216P... 1461
 12220P... 3210H
 12306P... 9125
 12324P... 9066
 12326P... 9053
 12326P... 9059H
 12328P... 9072
 12741P... 9084
 12764P... 9117
 12886P... 9070
 12895P... 9124
 12958P... 3225
 12963P... 9074
 13013P... 9114
 13168P... 3217
 13503P... 9115
 13504P... 9107
 13507P... 9123H
 13508P... 9085
 13509P... 3415
 145P... 1000
 200NP... 2103
 233P... 1410
 235NP... 1412
 244NP... 1250
 246AP... 1129
 2673PN... 7099D
 272AP... 1157
 272AP... 3188
 273AP... 1177
 275NP... 1120
 2773PNA... 3436D
 279P... 1724
 279P... 1748
 285AP... 1266
 285AP... 1266C
 295P... 1438
 302NP... 1119
 302NP... 3187
 310AP... 1423
 32NP... 1281
 332AP... 1633
 336P... 1144
 344P... 1630
 345NPS... 1436
 350NP... 1263
 351NP... 1814
 352AP... 1147
 354P... 1138
 357P... 1520
 362NCP... 2225C

362NP... 2225
 366AP... 1271
 368P... 1728
 369P... 1631
 37P... 1280
 37P... 3244
 381NP... 1130
 381NP... 1139
 392NCP... 1730
 397P... 1156
 398P... 1441
 399P... 1442
 400AP... 1443
 402P... 1445
 403CP... 1446C
 405P... 1279
 406AP... 1274
 411NP... 1526
 412P... 1434
 413AP... 1161
 416P... 1158
 417NP... 1525
 423NP... 1470
 424NP... 1276
 425NP... 1159
 426NP... 1448
 427NP... 1160
 428P... 1267
 433NP... 1164
 433NP... 1174
 449P... 1634
 450NP... 1749
 451P... 1167
 454NP... 1449
 455P... 1455
 456AP... 2226
 457P... 1539
 460P... 1433
 463P... 1171
 464CP... 1463C
 464P... 1463
 465AP... 1528
 466NP... 1635
 470AP... 2227
 472NP... 1636
 473P... 1818
 474P... 1458
 475NP... 1456
 478P... 1176
 480P... 1462
 481P... 1183
 485P... 1168
 488P... 1181
 489P... 1185
 493NP... 1468
 494P... 1190
 495P... 1197
 496P... 1734
 498NP... 1532
 502NP... 1820
 506P... 3169
 507P... 1192
 515P... 1469
 516CP... 1478C
 516P 1478 3128H
 517CP... 1195C
 517P... 1195
 520P... 1199

524P... 1287
 525ACP... 2228C
 525AP... 2228
 526AP... 3247
 527P... 1293
 531CP... 1492C
 532P... 1290H
 533P... 1291H
 534NP... 1482
 534NP... 3466
 536NCP... 1493C
 536NP... 1493
 536NP... 3492
 540P... 1481
 546P... 3126
 548P... 3100
 569P... 1488
 571CP... 3211C
 571P... 3211
 572P... 1823
 574CP... 3212C
 580P... 3491
 590P... 1736
 599P... 1446
 609P... 1817
 610P... 1191
 611P... 3513
 613519P... 9069
 640P... 3445
 642P... 3443
 645P... 3487
 656AP... 3246
 657P... 1746
 6678P... 3201
 677AP... 2229
 677CP... 2229C
 698P... 3444
 69P... 1717
 704P... 4537
 71P... 1718
 803CP... 3209C
 804NP... 3489
 817P... 3441
 836P... 9083
 88NP... 2606
 92P... 1422
 992P... 7058D
 992P... 7185D
 H1111CP 3515HC
 H1118CP 1903HC
 H1120CT 3495HC
 H1127CPA3519HC
 H1128CPA3516HC
 H1129DCPA.3517HC
 H1131CT 3460HC
 H1132CPA.3520HC
 H13130P... 3213H
 H251P... 3219D
 H254P... 1272D
 H273CP... 1177HC
 H336CP... 1144HC
 H345DCP... 3437H
 H345DCP 3437HC
 H392NCP... 1730H
 H395P... 1131H
 H400CP... 1443HC
 H405CP... 1279HC
 H418CP... 1143HC

H423ACP... 1476H
 H423ACP 1476HC
 H471CP... 1732HC
 H471P... 1732H
 H491P... 1184H
 H497P... 1193H
 H497P... 1193HC
 H518CP... 3403HC
 H519P... 1186H
 H521ACP 1735HC
 H521AP... 1735H
 H523CP... 3128HC
 H523P
 H529P... 3119H
 H531P... 1492
 H534NP... 1482HC
 H534P... 3467H
 H534P... 1482H
 H535CP... 3191HC
 H535P... 3191H
 H537P... 3124H
 H542P... 1194H
 H547CP... 1533HC
 H547P... 1533H
 H549P... 3121H
 H553CP... 1528HC
 H553CP... 1540HC
 H554P... 3158H
 H558CP... 1738HC
 H558P... 1738H
 H560P... 1538H
 H561CP... 1496HC
 H562CP... 1486HC
 H564P... 1743H
 H565P... 1536H
 H566P... 1642H
 H570P... 3156H
 H579P... 3223H
 H580CP... 3462HC
 H580P... 3462H
 H581CP... 3474HC
 H582CP... 3109HC
 H582P... 3109H
 H586P... 3414H
 H587P... 1467D
 H591CP... 3135HC
 H597ACP 1489HC
 H604CP... 3401D
 H605P... 1288H
 H606P... 3133H
 H611P... 3513
 H612CP... 3157HC
 H612P... 3157H
 H614CP... 3179HC
 H621P... 3154H
 H622P... 1744H
 H627NP... 3514
 H637AP... 3422H
 H637CP... 3422HC
 H640ACP 3490HC
 H643P... 3467H
 H651CP... 7098D
 H653CP... 3166HC
 H653P... 3166H
 H654CP... 3165H
 H654CP... 3165HC
 H655CP... 3222HC
 H661CP... 1448HC

H661P... 1448H
 H663CP... 3184HC
 H667P... 3151H
 H672P... 3162H
 H674P... 3171H
 H675CP... 3181H
 H675P... 3181HC
 H676P... 3185H
 H684CP... 3483HC
 H687CPA 1750HC
 H689CP... 3237HC
 H692CP... 3477HC
 H693CP... 3475HC
 H694CP... 3224HC
 H695CP... 3476HC
 H695P... 3476H
 H696CP... 3236HC
 H696P... 3236H
 H697CP... 3214HC
 H699P... 3451H
 H705P... 3194H
 H706P... 3195H
 H707P... 1173H
 H719CP... 3481HC
 H721CP... 3461HC
 H723CP... 3189HC
 H723P... 3189H
 H723P... 1175D
 H727CP... 3408HC
 H729CP... 7096D
 H729CP... 7096D
 H730CP... 3170HC
 H734CP... 3150HC
 H734P... 3150H
 H749CP... 3440HC
 H800P... 3420H
 H801CP... 1639HC
 H802CP... 3241HC
 H809CP... 3459HC
 H811CP... 3479HC
 H811CP... 3410H
 H811CP... 3448D
 H814CP... 3234HC
 H814P... 3234H
 H815DCP... 3470H
 H815P... 3451H
 H816CP... 3173HC
 H819CP... 3456HC
 H820CP... 3159HC
 H821CP... 1537HC
 H821P... 1537H
 H822CP... 3238HC
 H823CP... 3243HC
 H824CP... 3463HC
 H824P... 3463H
 H825CP... 3242HC
 H826CP... 3452HC
 H828P... 9076H
 H829CP... 3160HC
 H831CP... 3180HC
 H832CP... 9075
 H834CP... 3201HC
 H836CP... 9083HC
 H837CP... 3442HC
 H837CP... 3442H
 H840CP... 1745HC
 H840CP... 1745H
 H842CP... 3239HC

H843CP... 3155HC
 H844CP... 1900HC
 H845CP... 1902HC
 H846CP... 1901HC
 H847CP... 3439HC
 H848CP... 3167HC
 H849CP... 3183HC
 H850CP... 3152HC
 H851CP... 3478HC
 H852CP... 3229HC
 H853CP... 3228HC
 H855CP... 3482HC
 H856CP... 3472HC
 H857CP... 3473HC
 H858CP... 3174HC
 H861CP... 7186D
 H862CP... 3235HC
 H864CP... 3175HC
 H866CP... 3196HC
 H868CP... 3498HC
 H871CT... 1747HC
 H873CP... 1826HC
 H875CP... 3197HC
 H877CP... 3190HC
 H877P... 1825
 H881CP... 3185HC
 H882CP... 3512HC
 H883CP... 3252HC
 H885CP... 3161HC
 H889CP... 3496HC
 H896CP... 1491H
 H897CP... 3493HC
 H899CPA 3248HC
 H909CP... 3468HC
 H909P... 3468H
 H958CP... 1435D
 H989CP... 1440D
 H994P... 3144D
 H994P... 3176H
 H995P... 3145D
 H995P... 3177H
 H996CP... 7080D
 H997CP... 7082D
 H997CP... 7187D
 H999P... 7084D
 HLC702CP 3172HC
 LC244P... 1294
 LC291NP... 3454
 LC371P... 1278

INTERCHANGE LISTING

SILVOLITE TO FM/SEALED POWER

1000.....145P	1293.....527P	1630.....344P	3145D....H995P	3229HC...H852CP	3481HC...H719CP
1058....1003NP	1294....LC244P	1631.....369P	3150H....H734P	3230C....866CP	3482HC...H855CP
1066....1031NP	1410.....233P	1633.....332AP	3150HC...H734CP	3234H....H814P	3483HC...H684CP
1072....1022NP	1412.....235NP	1634.....449P	3151H....H667P	3234HC...H814CP	3485....1107NP
1079.....1011P	1413.....1009P	1635.....466NP	3152HC...H850CP	3235HC...H862CP	3486....1108NP
1119....302NP	1422.....92P	1636....1472NP	3154H....H621P	3236H....H696P	3487.....645P
1120....275NP	1423.....310AP	1639HC...H801CP	3155HC...H843CP	3236HC...H696CP	3489....804NP
1129....246AP	1433.....460P	1642H....H566P	3156H....H570P	3237HC...H689CP	3490HC...H640ACP
1130....381NP	1434.....412P	1717.....69P	3157H....H612P	3238HC...H822CP	3491.....580P
1131H....H395P	1435D...H958CP	1718.....71P	3157HC...H612CP	3239HC...H842CP	3492....536NP
1136....329NP	1436.....345NP	1724.....279P	3158H....H554P	3241HC...H802CP	3493HC...H897CP
1138.....354P	1438.....295P	1728.....368P	3158HC...H554CP	3242HC...H825CP	3494HC...H880CP
1139....381NP	1440D...H989CP	1730....392NCP	3159HC...H50CP	3243HC...H823CP	3495HC...H1120CT
1143HC...H418CP	1441.....398P	1730H...H392NCP	3160HC...H829CP	3244.....37P	3496HC...H889CP
1144.....336P	1442.....399P	1732H...H471P	3161HC...H885CP	3246....656AP	3498HC...H868CP
1144HC...H336CP	1443.....400AP	1732HC...H471CP	3162H....H672P	3247.....526AP	3512HC...H882CP
1146HC...H555CP	1443HC...H400CP	1734.....496P	3165H....H654P	3248HC...H899CPA	3513.....H611P
1147....352AP	1445.....402P	1735H...H521AP	3165HC...H654CP	3252HC...H883CP	3514....H627NP
1156.....397P	1446.....599P	1735HC H521ACP	3166H....H653P	3255HC...H1121CP	3515HC...H1111CP
1157....272AP	1446C...403CP	1736.....590P	3166HC...H653CP	3330.....416P	3516HC...H1128CPA
1158.....416P	1448....426NP	1738H...H558P	3167HC...H848CP	3252HC...H883CP	3330.....416P
1159....425NP	1448HC...H661CP	1738HC...H558CP	3168HC...H865CP	3401D...H604CP	3252HC...H883CP
1160....427NP	1448H...H661P	1743H...H564P	3169.....506P	3403HC...H518CP	3401D...H604CP
1161....413AP	1449....454NP	1744H...H622P	3170HC...H730CP	3408HC...H727CP	3403HC...H518CP
1164....433NP	1455....455P	1745H...H840CP	3171H....H674P	3410H...H811CP	3408HC...H727CP
1167....451P	1456....475NP	1745HC...H840CP	3172HC HLC702CP	3414H...H586P	3410H...H811CP
1168....485P	1458....474P	1746....657P	3173HC...H816CP	3415....13509P	3414H...H586P
1171.....463P	1461....12216P	1747HC...H871CT	3174HC...H858CP	3420H...H800P	3415....13509P
1173H...H707P	1462.....480P	1748....279P	3175HC...H864CP	3422H...H637AP	3420H...H800P
1174....433NP	1463.....464P	1749....450NP	3176H...H994P	3422HC...H637CP	3422H...H637AP
1175D...H723P	1463C...464CP	1750HC H687CPA	3177H...H995P	3436D...2773PNA	3422HC...H637CP
1176....478P	1467D...H587P	1814....351NP	3179HC...H614CP	3437HC...H345DCP	3436D...2773PNA
1177....273AP	1468....493NP	1817.....609P	3180HC...H831CP	3439HC...H847CP	3437HC...H345DCP
1177HC...H273CP	1469.....515P	1818....473P	3181H...H675CP	3440HC...H749CP	3439HC...H847CP
1181.....488P	1470....423NP	1820.....502P	3181HC...H675P	3441.....817P	3440HC...H749CP
1182....12215P	1476HC H423ACP	1823.....572P	3182HC...H881CP	3442HC...H837CP	3441.....817P
1183.....481P	1478.....516P	1825.....887P	3183HC...H849CP	3443.....642P	3442HC...H837CP
1184H...H491P	1478C...516CP	1826HC...H873CP	3184HC...H663CP	3444.....698P	3443.....642P
1185.....489P	1481.....540P	1900HC...H844CP	3185H...H676P	3445.....640P	3444.....698P
1186H...H519P	1482....534NP	1901HC...H846CP	3186....1011P	3445C...H640ACP	3445.....640P
1190....494P	1482H...H534P	1902HC...H845CP	3187....302NP	3448D...H811CP	3445C...H640ACP
1191.....610P	1482HC...H534NP	1903HC...H1118CP	3188....272AP	3451H...H699P	3448D...H811CP
1192....507P	1486HC...H562CP	2103....200NP	3189H...H723P	3451H...H815P	3451H...H699P
1193H...H497P	1488....569P	2225....362NP	3189HC...H723CP	3452HC...H826CP	3451H...H815P
1194H...H542P	1489HC H597ACP	2225C...362NCP	3190HC...H877CP	3454...LC291NP	3452HC...H826CP
1195.....517P	1491H...H896CP	2226....456AP	3191H...H535P	3456HC...H819CP	3454...LC291NP
1195C...517CP	1492.....531P	2227....470AP	3191HC...H535CP	3459HC...H809CP	3456HC...H819CP
1197....495P	1492C...531CP	2228....525AP	3194H...H705P	3460HC...H1131CT	3459HC...H809CP
1199.....520P	1493....536NP	2228C...525ACP	3195H...H706P	3461HC...H721CP	3460HC...H1131CT
1250....244NP	1493C...536NCP	2229....677AP	3196HC...H886CP	3462H...H580P	3461HC...H721CP
1263....350NP	1496HC...H561CP	2229C...677ACP	3197HC...H875CP	3462HC...H580CP	3462H...H580P
1266....285AP	1516.....288P	2234....1079NP	3201.....6678P	3463H...H824P	3462HC...H580CP
1266C...285AP	1520....357P	2606....88NP	3201HC...H834CP	3463HC...H824CP	3463H...H824P
1267....428P	1525.....417NP	3100.....548P	3209C...803CP	3466....534NP	3463HC...H824CP
1271....366AP	1526....411NP	3101HC...H273CP	3210H...12220P	3467H...H643P	3466....534NP
1272D...H254P	1527.....457P	3109H...H582P	3211.....571P	3468H...H909P	3467H...H643P
1274....406AP	1528....465AP	3109HC...H582CP	3211C...571CP	3468HC...H909CP	3468H...H909P
1276....424NP	1528HC...H553CP	3119H...H529P	3212C...574CP	3470HC...H815DCP	3468HC...H909CP
1278....LC371P	1532....498NP	3121H...H549P	3213H...H13130P	3472HC...H856CP	3470HC...H815DCP
1279....405P	1533H...H547P	3124H...H537P	3214HC...H697CP	3473HC...H857CP	3472HC...H856CP
1279HC...H405CP	1533HC...H547CP	3126.....546P	3217....13168P	3474HC...H581CP	3473HC...H857CP
1280.....37P	1536H...H565P	3128H...H523P	3219D...H251P	3475HC...H693CP	3474HC...H581CP
1281.....32NP	1537H...H821P	3128HC...H523CP	3222HC...H655CP	3476H...H695P	3475HC...H693CP
1287.....524P	1537HC...H821CP	3133H...H606P	3223H...H579P	3476HC...H695CP	3476H...H695P
1288H...H605P	1538H...H560P	3135HC...H591CP	3224HC...H694CP	3477HC...H692CP	3476HC...H695CP
1290H...532P	1539....457P	3136....1070P	3225....12958P	3478HC...H851CP	3477HC...H692CP
1291H...533P	1540HC...H553CP	3144D...H994P	3228HC...H853CP	3479HC...H811CP	3478HC...H851CP

DETERMINING COMPRESSION RATIO

The calculation of compression ratios (C.R.) is based on the following formula:

$$\text{Compression ratio} = \frac{\text{SWEPT VOL.} + \text{TDC VOL.}}{\text{TDC VOL.}}$$

$$\text{Swept Vol.} = \frac{3.1416 \times \text{BORE DIA.} \times \text{BORE DIA.} \times \text{STROKE}}{4}$$

T.D.C. Vol. = Head vol. + gasket vol. + deck vol. + dish/dome vol.

Head Vol. = is published or measured in cubic centimeters (cc)

$$\text{Gasket Vol.} = \frac{3.1416 \times \text{GASKET BORE} \times \text{GASKET BORE} \times \text{COMPRESSED GASKET THICKNESS}}{4}$$

$$\text{Deck Vol.} = \frac{3.1416 \times \text{BORE DIA.} \times \text{BORE DIA.} \times \text{DECK CLEARANCE}}{4}$$

Dish/Dome Vol. = is published or measured in cc's.

NOTE: Any volume below the piston compression height is a positive value and any volume above the piston compression height is a minus value.

DIMENSIONS: When calculating use cubic centimeters or cubic inches but do not mix them. The following conversions are listed:

- 1 inch = 2.54 centimeters
- .061 cubic inch = 1 cubic centimeter (cc)
- 1 cubic inch = 16.387 cubic centimeters

EXAMPLE: Find C.R. for a Chevy 350 using 1470 STD. pistons:

Head Vol. = 64cc = 64 x .061 = **3.904 cubic inches**

Dish/Dome Vol. = 13cc = 13 x .061 = **.793 cubic inches**

Gasket Thickness = **.021"**

Gasket Bore Dia = **4.15"**

Deck Clearance = **.025"**

$$\text{Deck Vol.} = \frac{3.1416 \times 4.00'' \times 4.00'' \times .025''}{4} = \mathbf{.314 \text{ cubic inches}}$$

$$\text{Gasket Vol.} = \frac{3.1416 \times 4.15'' \times 4.15'' \times .021''}{4} = \mathbf{.284 \text{ cubic inches}}$$

$$\text{Swept Vol.} = \frac{3.1416 \times 4.00'' \times 4.00'' \times 3.48''}{4} = \mathbf{43.731 \text{ cubic inches}}$$

$$\text{TDC Vol.} = 3.904 + .793 + .314 + .284 = \mathbf{5.295 \text{ cubic inches}}$$

$$\text{COMPRESSION RATIO} = \frac{43.731 + 5.295}{5.295} = \mathbf{9.258}$$

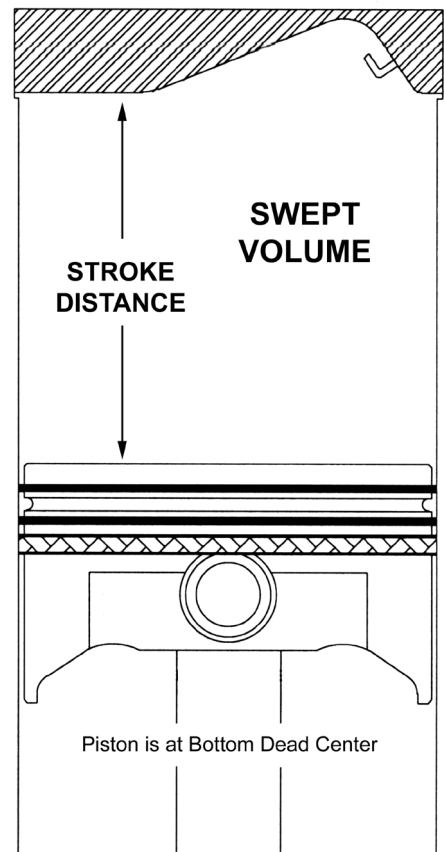
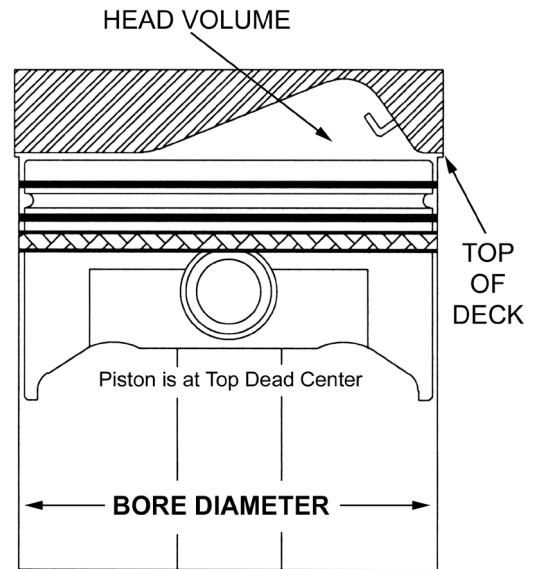

See www.uempistons.com for static and dynamic compression calculators.

CHECKING CLEARANCE FOR SILVOLITE PISTONS

1. Follow the "RECOMMENDED FINISHED BORE DIAMETER" information on the piston container label.

2. PISTON TO CYLINDER CLEARANCE

Honing a cylinder to a finished diameter of the nominal bore size plus the piston oversize will provide proper piston to cylinder clearance for normal operation.

Example: Chevrolet 350
1436 Piston
(4.0000" nominal bore diameter)
+ (.030" oversize) = 4.0300"
Hone the cylinder to 4.0300"
for a .030" oversize piston

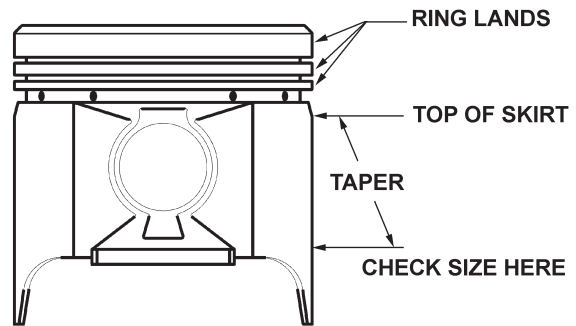

3. Some STD pistons are larger in diameter than the O.E. to allow for the honing of standard cylinder bores for ring seating (without increasing piston to cylinder clearance) Follow the "RECOMMENDED FINISHED BORE DIAMETER" information on the piston container label

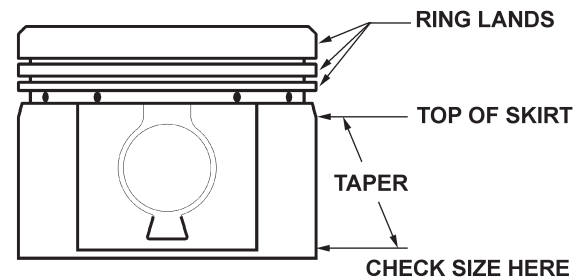

4. When resizing the cylinders of a metric engine it is very important that you use millimeter oversizes for your calculations: **.25mm = .009843** **.5mm = .019685**
.75mm = .029528 **1.0mm = .039370** **1.5mm = .059055**

5. *Pistons used in severe duty or marine applications may require additional clearance*

6. Piston skirt sizes should be measured at the bottom of full-skirted pistons and one-third of the skirt length above the bottom of slipper type pistons. Do not check for size at the tips of the slippers, as they deflect during measurement and during operation.

7. Pistons should be at 70°F when checked for size as a 10° variation from that temperature is enough to cause a measurable size deviation

8. Clearances listed are to be used as a guideline only & are subject to change without notice. Should you find a discrepancy between actual clearances & those shown, please call our toll free number **1-800-648-7970** for clarification.

**1467D PISTON TO WALL CLEARANCE
GM 6.2 LITER DIESEL (379).**

Recommended piston to cylinder wall clearance for the 6.2 liter should be .0045" when piston diameter is measured even with bottom of pin boss (see drawing). **On rear cylinders 7 and 8 an additional .0005" clearance is recommended for normal service and an additional .001" is recommended for heavy/severe duty service.**

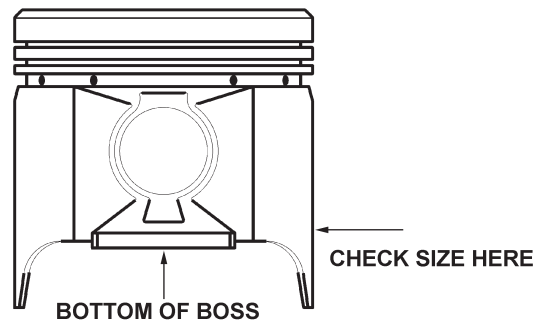

CLEARANCE CHART FOR SILVOLITE PISTONS

Note: Follow the "Recommended Finish Bore Diameter" information on the piston container label.

Piston	Cyl dia (in)	Clearance
1000	3.8750	0.0020
1058	3.1875	0.0015
1066	3.8000	0.0015
1072	3.7500	0.0015
1079	3.6250	0.0015
1106	3.8000	0.0015
1116	4.0500	0.0015
1119	3.5000	0.0015
1120	3.6800	0.0015
1129	4.0000	0.0015
1130	4.0500	0.0015
1131	4.0500	0.0015
1131H	4.0500	0.0013
1136	3.8750	0.0020
1138	4.1300	0.0015
1139	4.0500	0.0015
1143	4.3600	0.0015
1143HC	4.3600	*Coated Skirts
1144	4.0000	0.0015
1144HC	4.0000	*Coated Skirts
1146	4.0000	0.0015
1146HC	4.0000	*Coated Skirts
1147	4.0000	0.0015
1156	3.5750	0.0015
1157	4.0000	0.0015
1158	4.0000	0.0015
1159	4.0000	0.0015
1160	4.0000	0.0015
1161	4.3600	0.0015
1163	3.7795	0.0015
1164	3.6614	0.0015
1167	4.0000	0.0015
1168	3.0709	0.0014
1170	4.0000	0.0015
1171	4.0000	0.0015
1171HC	4.0000	*Coated Skirts
1173D	4.0500	0.0020
1173H	4.0500	0.0017
1174	3.6614	0.0015
1175D	4.3600	0.0025
1176	3.6800	0.0015
1177	4.0000	0.0015
1177H	4.0000	0.0015
1177HC	4.0000	*Coated Skirts
1181	3.1496	0.0026
1182	3.1496	0.0013
1183	3.8110	0.0015
1184	3.5180	0.0015
1184H	3.5180	0.0013
1185	3.6800	0.0015
1186	4.0000	0.0015
1186H	4.0000	0.0013
1190	3.2260	0.0021
1191	3.2260	0.0021
1192	3.6811	0.0015
1193H	3.5039	0.0013
1193HC	3.5039	*Coated Skirts
1194H	3.2260	0.0012
1195	4.0000	0.0015
1195C	4.0000	*Coated Skirts
1197	3.7795	0.0015
1199	3.6614	0.0015

Piston	Cyl dia (in)	Clearance
1250	3.4000	0.0015
1263	4.3200	0.0015
1266	3.9100	0.0015
1266C	3.9100	*Coated Skirts
1267	4.0400	0.0015
1271	4.2500	0.0015
1272D	4.1880	0.0020
1273	4.0000	0.0015
1274	4.3420	0.0015
1276	4.3200	0.0015
1278	3.9100	0.0015
1279	4.0000	0.0015
1279HC	4.0000	*Coated Skirts
1280	3.2500	0.0015
1281	3.4370	0.0015
1287	3.4449	0.0014
1288H	3.5866	0.0010
1290H	3.4449	0.0024
1291H	3.4449	0.0013
1292	3.4449	0.0015
1293	3.4449	0.0015
1294	3.4000	0.0015
1410	3.7500	0.0015
1412	3.8750	0.0015
1413	3.5625	0.0015
1422	3.7500	0.0015
1423	4.0000	0.0015
1429	3.8750	0.0025
1433	4.0937	0.0015
1434	4.2500	0.0015
1435D	3.9370	0.0015
1436	4.0000	0.0015
1436C	4.0000	*Coated Skirts
1437	3.8750	0.0025
1438	3.8750	0.0015
1440D	4.2500	0.0025
1441	4.0000	0.0015
1442	4.0000	0.0015
1443	4.1250	0.0015
1443HC	4.1250	*Coated Skirts
1445	4.1250	0.0015
1446	3.8750	0.0015
1446C	3.8750	*Coated Skirts
1448	4.2500	0.0020
1448H	4.2500	.0020
1448HC	4.2500	*Coated Skirts
1449	3.7360	0.0015
1455	3.2283	0.0010
1456	3.5000	0.0015
1458	3.2283	0.0010
1461	3.4252	0.0015
1462	3.3071	0.0015
1463	3.5039	0.0012
1463C	3.5039	*Coated Skirts
1467D	3.9764	0.0045
1468	3.5039	0.0012
1469	3.5039	0.0012
1470	4.0000	0.0015
1472	4.0000	0.0015
1476H	4.0000	0.0013
1476HC	4.0000	*Coated Skirts
1478	3.5039	0.0012

Piston	Cyl dia (in)	Clearance
1478C	4.0000	*Coated Skirts
1479H	4.0000	0.0013
1481	3.5039	0.0015
1482	3.7360	.0015
1482H	3.7360	0.0015
1482HC	3.7360	*Coated Skirts
1486	3.5039	0.0016
1486HC	3.5039	*Coated Skirts
1487	4.0000	0.0015
1488	3.5039	0.0015
1489H	4.0000	0.0015
1489HC	4.0000	*Coated Skirts
1490D	3.9375	0.0020
1491H	4.0000	0.0020
1492	3.5039	0.0016
1492C	3.5039	*Coated Skirts
1493	3.7360	0.0015
1493C	3.7360	*Coated Skirts
1496	3.5039	0.0016
1496H	3.5039	0.0013
1496HC	3.5039	*Coated Skirts
1516	4.0625	0.0015
1520	3.8750	0.0015
1525	4.1500	0.0015
1526	4.1200	0.0015
1527	4.0000	0.0015
1528	4.0000	0.0025
1528HC	4.0000	*Coated Skirts
1531	4.0000	0.0015
1532	4.0000	0.0025
1533H	4.0000	0.0013
1533HC	4.0000	*Coated Skirts
1536H	3.3858	0.0013
1537H	3.3858	0.0013
1537HC	3.3858	*Coated Skirts
1538H	3.3858	0.0015
1539	4.0000	0.0015
1540HC	4.0000	*Coated Skirts
1630	4.1250	0.0015
1631	4.1250	0.0015
1633	4.0570	0.0015
1634	3.5000	0.0015
1635	4.3510	0.0015
1636	3.8000	0.0015
1637D	4.0570	0.0035
1639	3.8000	0.0015
1639HC	3.8000	*Coated Skirts
1642H	3.6220	0.0013
1717	4.1870	0.0015
1718	3.5000	0.0015
1724	3.7500	0.0015
1728	4.1875	0.0015
1730	4.3130	0.0025
1730H	4.3130	.0025
1731	3.8000	0.0015
1732H	3.9650	0.0013
1732HC	3.9650	*Coated Skirts
1734	3.8000	0.0015
1735H	3.8000	0.0013
1735HC	3.8000	*Coated Skirts
1736	3.8000	0.0015
1738H	3.7992	0.0016

* See page (5) for Coated Piston Clearances. Engines operating in severe duty conditions may require additional Piston to Cylinder Clearance.

CLEARANCE CHART FOR SILVOLITE PISTONS

Note: Follow the "Recommended Finish Bore Diameter" information on the piston container label.

Piston	Cyl dia (in)	Clearance
1738HC	3.8000	*Coated Skirts
1740H	3.8000	0.0015
1743H	3.7000	0.0013
1744H	3.7992	0.0017
1745H	3.7992	0.0015
1745HC	3.7992	*Coated Skirts
1746	3.8000	0.0015
1747H	3.7992	0.0015
1747HC	3.7992	*Coated Skirts
1748	3.7500	0.0015
1749H	3.8000	0.0015
1750HC	3.7992	*Coated Skirts
1751H	3.8000	0.0012
1752H	3.8000	0.0012
1753H	3.8000	0.0015
1754HC	3.8000	*Coated Skirts
1755H	3.8000	0.0015
1756H	3.6270	0.0015
1757H	3.6270	0.0015
1758HC	3.7008	*Coated Skirts
1759H	4.0005	0.0015
1760H	4.0005	0.0015
1761H	4.0005	0.0015
1762H	3.6270	0.0015
1763H	3.6267	0.0015
1764H	4.0005	0.0015
1765HC	3.7008	*Coated Skirts
1766HC	3.5039	*Coated Skirts
1767HC	3.6267	*Coated Skirts
1768H	3.6267	0.0020
1769H	3.6267	0.0020
1814	4.3000	0.0010
1815	4.3000	0.0010
1817	4.3000	0.0010
1818	4.0820	0.0015
1820	3.4646	0.0015
1822	3.6220	0.0013
1823	3.6220	0.0012
1825	3.3858	0.0014
1826H	3.6614	0.0013
1826HC	3.6614	*Coated Skirts
1900HC	3.2283	*Coated Skirts
1901HC	3.2283	*Coated Skirts
1902HC	3.2283	*Coated Skirts
1903HC	3.2283	*Coated Skirts
2103	3.3130	0.0020
2225	4.0800	0.0015
2225C	4.0800	*Coated Skirts
2226	3.7500	0.0015
2227	3.7500	0.0015
2228	3.8750	0.0015
2228C	3.8750	*Coated Skirts
2229	3.8750	0.0015
2229C	3.8750	*Coated Skirts
2234	3.7500	0.0015
2606	3.1250	0.0020
3100	3.3858	0.0016
3101HC	4.0000	*Coated Skirts
3109	4.3600	0.0015
3109H	4.3600	0.0013
3109HC	4.3600	*Coated Skirts
3117H	4.0000	0.0015

Piston	Cyl dia (in)	Clearance
3118H	4.0000	0.0015
3119	3.2260	0.0020
3119H	3.2260	0.0018
3121H	3.3858	0.0013
3124H	3.7795	0.0013
3126	2.7953	0.0013
3128H	3.8110	0.0013
3128HC	3.8110	*Coated Skirts
3133H	4.0000	0.0022
3133HC	4.0000	*Coated Skirts
3135H	3.5512	0.0013
3135HC	3.5512	*Coated Skirts
3136	4.0000	0.0015
3141D	4.0000	0.0015
3144D	4.0500	0.0020
3145D	4.0500	0.0020
3150H	4.3600	0.0020
3150HC	4.3600	*Coated Skirts
3151H	3.9527	0.0015
3152H	3.8122	0.0017
3152HC	3.8122	*Coated Skirts
3154H	4.0000	0.0013
3155HC	3.9527	*Coated Skirts
3156H	3.9527	0.0013
3156HC	3.9527	*Coated Skirts
3157H	4.3600	0.0015
3157HC	4.3600	*Coated Skirts
3158H	4.0000	0.0015
3158HC	4.0000	*Coated Skirts
3159H	3.8110	0.0013
3159HC	3.8110	*Coated Skirts
3160HC	3.5512	*Coated Skirts
3161HC	3.5512	*Coated Skirts
3162H	3.3409	0.0013
3163	3.9000	0.0015
3164H	4.3600	0.0020
3165H	4.0000	0.0022
3165HC	4.0000	*Coated Skirts
3166H	4.0000	0.0013
3166HC	4.0000	*Coated Skirts
3167H	3.3409	0.0016
3167HC	3.3409	*Coated Skirts
3168	3.7795	0.0013
3168H	3.7795	0.0013
3168HC	3.7795	*Coated Skirts
3169	4.0000	0.0015
3170HC	4.3600	*Coated Skirts
3171H	4.0000	0.0015
3172HC	4.0500	*Coated Skirts
3173HC	4.0000	*Coated Skirts
3174HC	3.5512	*Coated Skirts
3175HC	3.5512	*Coated Skirts
3176H	4.0500	0.0015
3177H	4.0500	0.0015
3179HC	3.5512	*Coated Skirts
3180HC	3.5512	*Coated Skirts
3181H	3.8110	0.0015
3181HC	3.8110	*Coated Skirts
3182HC	3.5041	*Coated Skirts
3183HC	3.2400	*Coated Skirts
3184HC	3.2400	*Coated Skirts
3185H	3.7795	0.0015

Piston	Cyl dia (in)	Clearance
3186	3.6250	0.0015
3187	3.5000	0.0015
3188	4.0000	0.0015
3189H	4.3600	0.0020
3189HC	4.3600	*Coated Skirts
3190HC	3.5512	*Coated Skirts
3191H	4.3600	.0015
3191HC	4.3600	*Coated Skirts
3192H	4.0500	.0015
3193	4.0500	.0015
3194H	4.0500	.0015
3195H	4.0500	.0015
3196HC	3.5512	*Coated Skirts
3197HC	3.5039	*Coated Skirts
3201	3.5866	0.0015
3201HC	3.5866	*Coated Skirts
3209	3.7795	0.0015
3209C	3.7795	*Coated Skirts
3210H	3.5866	0.0013
3211	3.4449	0.0013
3211C	3.4449	*Coated Skirts
3212	3.6614	0.0015
3212C	3.6614	*Coated Skirts
3213H	2.9724	0.0010
3214HC	3.7795	*Coated Skirts
3215	3.6614	0.0020
3216	3.1732	0.0015
3217	3.3465	0.0015
3219D	4.1250	0.0020
3220	3.1890	0.0013
3221	3.4055	0.0015
3222	4.0000	0.0015
3222HC	4.0000	*Coated Skirts
3223H	3.4449	0.0013
3224HC	3.5866	*Coated Skirts
3225	3.4055	0.0012
3228	3.4449	0.0010
3228HC	3.4449	*Coated Skirts
3229HC	3.4449	*Coated Skirts
3230C	3.6614	*Coated Skirts
3233	3.4449	0.0012
3234H	3.9100	0.0012
3234HC	3.9100	*Coated Skirts
3235HC	3.3859	*Coated Skirts
3236H	3.9100	0.0013
3236HC	3.9100	*Coated Skirts
3237HC	4.0000	*Coated Skirts
3238HC	3.8750	*Coated Skirts
3239HC	3.7795	*Coated Skirts
3241HC	3.8750	*Coated Skirts
3242HC	3.8750	*Coated Skirts
3243HC	3.8750	*Coated Skirts
3244	3.2500	0.0015
3245C	3.7795	*Coated Skirts
3246	3.9100	0.0015
3247	3.9100	0.0015
3248HC	3.9173	*Coated Skirts
3249HC	3.4449	*Coated Skirts
3250HC	3.4449	*Coated Skirts
3251HC	3.6614	*Coated Skirts
3252HC	3.6614	*Coated Skirts
3255HC	3.7795	*Coated Skirts

* See page (5) for Coated Piston Clearances. Engines operating in severe duty conditions may require additional Piston to Cylinder Clearance.

CLEARANCE CHART FOR SILVOLITE PISTONS

Note: Follow the "Recommended Finish Bore Diameter" information on the piston container label.

Piston	Cyl dia (in)	Clearance
3257HCA	3.9173	*Coated Skirts
3258HCA	4.0551	*Coated Skirts
3259HC	3.7800	*Coated Skirts
3260HCA	3.9170	*Coated Skirts
3261HCA	3.6610	*Coated Skirts
3322	2.9120	0.0013
3323HC	3.5512	*Coated Skirts
3324H	3.6329	0.0017
3325H	3.6329	0.0017
3326H	3.6329	0.0017
3327H	3.6807	0.0015
3328H	3.6807	0.0015
3329H	4.0000	0.0015
3330	4.0000	0.0015
3331H	3.6176	0.0016
3332H	3.6807	0.0015
3333H	3.6323	0.0015
3334HC	3.6319	*Coated Skirts
3335HC	3.5512	*Coated Skirts
3336HC	3.6417	*Coated Skirts
3338HC	3.5512	*Coated Skirts
3339HCA	3.6417	*Coated Skirts
3340HCA	3.6417	*Coated Skirts
3401D	4.2500	0.0025
3403HC	4.2500	*Coated Skirts
3408H	4.2500	0.0025
3408HC	4.2500	*Coated Skirts
3409	3.6220	0.0015
3410H	3.9380	0.0025
3411H	4.0000	0.0015
3412	3.2283	0.0010
3413	4.0000	0.0020
3414H	2.9528	0.0010
3415	2.9134	0.0013
3420H	3.6220	0.0013
3422	3.5039	0.0015
3422H	3.5039	0.0013
3422HC	3.5039	*Coated Skirts
3436D	4.0551	0.0055
3437H	4.0000	0.0015
3437HC	4.0000	*Coated Skirts
3439	3.6220	0.0020
3439HC	3.6220	*Coated Skirts
3440H	4.2500	0.0025
3440HC	4.2500	*Coated Skirts
3441	3.7360	0.0015
3442H	3.5433	0.0013
3442HC	3.5433	*Coated Skirts
3443	3.5039	0.0012
3443C	3.5039	*Coated Skirts
3444	3.7360	0.0015
3445	4.0000	0.0015
3445C	4.0000	*Coated Skirts
3448D	3.9375	0.0020
3451H	4.0000	0.0015
3451HC	4.0000	*Coated Skirts
3452H	3.7360	0.0015
3452HC	3.7360	*Coated Skirts
3454	3.8750	0.0015
3455H	4.0000	0.0015
3456HC	4.0000	*Coated Skirts
3457H	4.0000	0.0015

Piston	Cyl dia (in)	Clearance
3458H	4.2500	0.0025
3458HC	4.2500	*Coated Skirts
3459C	3.5039	*Coated Skirts
3459HC	3.5039	*Coated Skirts
3460HC	3.5230	*Coated Skirts
3461HC	3.9380	*Coated Skirts
3462H	4.0000	0.0013
3462HC	4.0000	*Coated Skirts
3463H	4.0000	0.0013
3463HC	4.0000	*Coated Skirts
3466	3.7360	0.0015
3467H	3.7360	0.0013
3468H	3.8750	0.0025
3468HC	3.8750	*Coated Skirts
3469	3.4250	0.0010
3470H	4.0000	0.0015
3470HC	4.0000	*Coated Skirts
3471H	4.0000	0.0015
3472HC	3.7799	*Coated Skirts
3473HC	4.0000	*Coated Skirts
3474HC	4.2500	*Coated Skirts
3475HC	4.2500	*Coated Skirts
3476H	4.0000	0.0013
3476HC	4.0000	*Coated Skirts
3477HC	3.5039	*Coated Skirts
3478HC	3.5039	*Coated Skirts
3479HC	3.9375	*Coated Skirts
3481HC	3.9375	*Coated Skirts
3482HC	3.7799	*Coated Skirts
3483HC	3.6220	*Coated Skirts
3484	3.4250	0.0010
3485	3.8750	0.0015
3486	3.8750	0.0015
3487	4.0000	0.0015
3487C	4.0000	*Coated Skirts
3488	4.0000	0.0015
3489	3.5000	0.0015
3490H	4.0000	0.0013
3490HC	4.0000	*Coated Skirts
3491	4.0000	0.0015
3492	3.7360	0.0015
3492C	3.7360	*Coated Skirts
3493HC	4.0000	*Coated Skirts
3494HC	4.2500	*Coated Skirts
3494HCA	4.2500	*Coated Skirts
3495HC	3.3858	*Coated Skirts
3496HC	3.6614	*Coated Skirts
3497HC	3.6614	*Coated Skirts
3498HC	3.8976	*Coated Skirts
3499HC	3.8976	*Coated Skirts
3510HC	3.6614	*Coated Skirts
3511HC	3.6614	*Coated Skirts
3512HC	3.5039	*Coated Skirts
3513	3.7360	.0015
3514	3.7360	.0015
3515HC	3.6614	*Coated Skirts
3516HC	4.0000	*Coated Skirts
3517HC	4.0000	*Coated Skirts
3518HC	4.0000	*Coated Skirts
3519HC	3.7800	*Coated Skirts
3520HC	3.7800	*Coated Skirts
3523HC	4.0650	*Coated Skirts

Piston	Cyl dia (in)	Clearance
3524HC	3.6614	*Coated Skirts
3525HC	3.8976	*Coated Skirts
3526HCA	3.7795	*Coated Skirts
3527HCA	4.0000	*Coated Skirts
3530HCA	4.0650	*Coated Skirts
3531HC	3.8976	*Coated Skirts
3532HC	3.6614	*Coated Skirts
3535HC	3.7800	*Coated Skirts
3536HC	4.0000	*Coated Skirts
3537HCA	3.4646	*Coated Skirts
3538HCA	3.7008	*Coated Skirts
3539HCA	3.7008	*Coated Skirts
4501	3.4375	0.0020
4537	3.3130	0.0020
4538	3.4375	0.0020
7058D	3.8750	0.0030
7080D	4.1250	0.0030
7082D	3.8750	0.0030
7084D	4.1250	0.0020
7096D	4.0000	0.0050
7098D	4.1100	0.0055
7099D	4.5100	0.0050
7185D	3.8750	0.0030
7186D	4.1250	0.0030
7187D	3.8750	0.0030
9044	3.2677	0.0015
9045	3.2677	0.0015
9048	3.3465	0.0015
9049	3.4842	0.0014
9053	3.6220	0.0015
9059H	3.6220	0.0015
9066	3.1890	0.0017
9068	3.5827	0.0017
9069	3.4449	0.0009
9070	3.6220	0.0015
9071	3.3465	0.0015
9072	2.9921	0.0015
9074	3.2677	0.0015
9075	3.4252	0.0015
9076H	3.3465	0.0011
9077	3.1890	0.0015
9078	3.1890	0.0015
9079	3.0709	0.0019
9082	3.2283	0.0010
9083	2.9528	0.0010
9083HC	2.9528	*Coated Skirts
9084	3.5157	0.0018
9085	3.6457	0.0014
9088	3.2677	0.0020
9107	3.1890	0.0011
9109	3.1890	0.0011
9113	3.6220	0.0025
9114	3.5039	0.0012
9115	3.5039	0.0012
9116	3.5039	0.0012
9117	3.1890	0.0017
9121H	3.4449	0.0012
9122H	3.4449	0.0012
9123H	3.3465	0.0014
9124	2.8740	0.0015
9125	3.3858	0.0020
9126	2.9921	0.0012

* See page (5) for Coated Piston Clearances. Engines operating in severe duty conditions may require additional Piston to Cylinder Clearance.

CLEARANCE CHART FOR SILVOLITE PISTONS

Note: Follow the "Recommended Finish Bore Diameter" information on the piston container label.

Piston	Cyl dia (in)	Clearance
9127H	2.9921	0.0015
9128	2.9921	0.0015
9129	3.1693	0.0015
9134HC	3.4449	*Coated Skirts
9137HCA	3.6024	*Coated Skirts
9140HCA	3.8583	*Coated Skirts
9143HCA	3.9173	*Coated Skirts
9144HCA	3.9173	*Coated Skirts
9145HCA	3.9173	*Coated Skirts

Piston	Cyl dia (in)	Clearance

Piston	Cyl dia (in)	Clearance

* See page (5) for Coated Piston Clearances. Engines operating in severe duty conditions may require additional Piston to Cylinder Clearance.