

tilton

WINNING HERITAGE • QUALITY • VALUE • SUPPORT



CHOSEN SINCE
BY WINNERS 1972

History

In 1972, McLane (Mac) and Adelle Tilton founded Tilton Engineering in El Segundo, California. Their mission was to supply innovative, high-quality products at fair prices and with sound advice. Mac utilized his vast racing and machining experience, most notably as Crew Chief for the 1971 & 1972 Trans Am championship winning Brock Racing Enterprises (BRE) team, to develop some of the most innovative products of their time. Adelle's excellent business sense and experience helped to insure the long-term future of Tilton Engineering.

As Tilton Engineering's reputation grew, demand for its products increased. Tilton relocated in 1979 to Buellton, California where it is still located today. A new custom-built headquarters was completed in 2017, which includes the full machine shop, assembly area, warehouse, office space and a fully integrated quality assurance department.

Products

Tilton produces a wide range of driveline and brake components, in-cockpit controls and starter motors. Driveline components include clutches, flywheels, bellhousings and hydraulic release bearings. Brake components and in-cockpit controls include pedal assemblies, master cylinders, balance bars, proportioning valves and related accessories. Super Starters by Tilton were introduced in 1981 as the first high torque mini-starter for racing applications.

Tilton products are primarily designed for racing use and can be found worldwide in nearly every form of racing, winning numerous major races and championships each year. Tilton continues to expand its offerings to include products for the high-performance street market, such as with their ST-246 line of twin plate clutches and 6000-Series hydraulic release bearings.

Innovation

Of the numerous innovations Tilton has brought to the racing world, most recognized is the carbon/carbon racing clutch. Tilton's was the first carbon/carbon clutch to be used in F1, winning its first race at the 1987 Detroit Grand Prix in Ayrton Senna's Lotus-Honda. The technology developed by Tilton can be found in most carbon/carbon racing clutches of today. Tilton Engineering was awarded a US Patent and the Louis Schwitzer Award. Today, Tilton continues to introduce innovative products to the racing industry each year.

Engineering/Manufacturing/Quality Control

Tilton Engineering believes that having Engineering, Manufacturing and Quality Control within the same building is the best way to insure the highest quality products are delivered to customers. Our products are designed by experienced engineers, who understand the needs of racers, using the latest solid modeling CAD and Finite Element Analysis (FEA) software. 90% of our machined components are manufactured at our facility in Buellton, California using top-level equipment, including a Toyoda Horizontal Milling Center (HMC) and Mori Seike lathes. After machining, products are quality checked using Browne and Sharpe Coordinate Measuring Machines (CMM) and tested using proprietary equipment.

Service

A great product is nothing without great service behind it and Tilton prides itself in providing excellent customer service. Experienced Tilton employees, most who have been at Tilton for many years, are readily available to assist customers in selecting the most appropriate products and providing technical support. Tilton is supported by a worldwide network of dealers, who are the very best in the industry. These dealers know their customer's and make significant investments in inventory to service them quickly. They, along with Tilton's employees, are there to provide the customer with top-level service and the best purchase experience possible.

Contents

Clutches

ST-246 Clutch Flywheel Kits	3
Sport 5.5 Clutch Assemblies	4
5.5 ULTRA Clutch Assemblies	5
OT-II 7.25" Metallic Clutches	7
OT-III 5.5" Metallic Clutches	9
OT-II 7.25" Cerametallic Clutches	12
OT-II 7.25" Carbon/Carbon Clutches	14
OT-III 5.5" Carbon/Carbon Clutches	15
OT-V 4.5" Carbon/Carbon Clutches	16

Disc Packs

7.25" Cerametallic Disc Packs	18
7.25" Metallic Disc Packs	19
5.5" Metallic Disc Packs	21

Clutch Flywheel-Assemblies

Metallic Clutch-Flywheel-Assemblies	24
Cerametallic Clutch-Flywheel-Assemblies	25
Carbon Clutch-Flywheel-Assemblies	26

Bellhousing

99T 5.5" Bellhousing Kits	27
102T 5.5" Bellhousing Kits	29

Flywheels, Ring Gears & Bolt Kits

Flywheel & Ring Gears	31
Bolt Kits	33

Hydraulic Release Bearings (HRBs)

1000-Series HRBs	36
2000-Series HRBs	37
3000-Series HRBs	38
4000-Series HRBs	39
5000-Series HRBs	40

6000-Series HRBs	41
8000-Series HRBs	43
9000-Series & 700-Series HRBs	44
HRB Mount Adapters & Mechanical Release Bearings ..	45
Release Bearing Service Parts	46

Super Starters®

40000-Series Super Starters	47
XLT Super Starters	48
Cooler Pumps	49

Pedal Assemblies

600-Series

Underfoot (2 & 3 Pedal)	51
Floor-Mount (2 & 3-pedal)	52
Overhung, Firewall & Throttle	53

850-Series

Underfoot (Non-Slider, 2 & 3-Pedal)	55
Underfoot (Slider, 2 & 3-Pedal)	56

800-Series

Floor-Mount (2 & 3-Pedal)	57
Overhung & Firewall	58

900-Series

Floor-Mount, Overhung & Firewall	60
----------------------------------------	----

Master Cylinders

79-Series & 78-Series Master Cylinders	61
76-Series & 75-Series Master Cylinders	62
74-Series & 73-Series Master Cylinders	63
Master Cylinder Service parts	64
Reservoirs (3-Chamber & 1-Chamber)	65
Bias Adjusters, Balance Bars & Valves	66
Master Cylinder Sizing Form	67

There are many considerations when choosing a clutch that best meets your needs. The selection of clutches on the market is quite large, with a wide range of diameters, friction materials and disc counts. The general rule in selecting a racing clutch is to choose the smallest clutch diameter allowed by sanctioning body rules, determine how many discs it takes to meet your engine's torque capacity, and add one additional plate for heat capacity and durability reasons. For street use, larger diameter clutch such as Tilton's ST-246 range of clutches are recommended. The following is a list of factors to consider when selecting the right clutch for your application.

Metallic Racing Clutches: Lug-type clutch design that feature discs with a thin specialized metallic friction material sintered to the core plate. The thin (.104") friction disc offers low weight & inertia, has excellent wear resistance and withstands fairly high temperatures. Metallic clutches are the most commonly used clutch type in circle track and road racing. Tilton offers metallic clutches in their OT-Series 5.5" & 7.25", Sport 5.5 and 5.5 Ultra clutch models.



5.5 ULTRA
Racing Clutch

Cerametallic Racing Clutches: Lug-type clutch design that features discs with a thick ceramic and metallic friction material blend sintered to the core plate. Compared to the metallic clutch of the same number of discs, the thicker (.283") friction material provides increased heat capacity. In addition, the engagement characteristics are less aggressive than metallic clutches. Cerametallic clutches are commonly used in rally, short track off-road, club racing/track day and import drag racing.



7.25" OT-II Cerametallic
Racing Clutch

Carbon/Carbon Clutches: Tilton Engineering designed and patented (4,846,326) the first carbon/carbon clutch in 1989. Features driven and floater plate that are 100% carbon matrix. Tilton carbon/carbon clutches offer many advantages over other friction materials. They are by far the lightest of the clutch types, superior at withstanding high temperatures (will not warp from heat) and have the smoothest engagement characteristics. Although the initial purchase price is higher, their cost per mile is lower, especially when you consider that their smooth engagement can help increase the life of the transmission and other driveline components. Carbon/Carbon clutches are commonly used in road racing, endurance racing, open wheel/formula, rally, short course off-road, 1/2-mile racing, and higher power street/strip applications



7.25" OT-II Carbon
Racing Clutch

ST-246 Performance Street Clutches: Designed specifically for high performance street/strip use. Features a machined aluminum clutch cover that incorporates straps that are attached to the high-mass pressure plate and floater plate to minimum noise. ST-246 clutches are available with either sprung-hub organic discs for street use or solid-hub cerametallic discs for street/strip use. Designed from the ground up as performance twin disc clutch using Tilton 45+ years of experience in racing clutches, ST-246 clutches are competitively priced and are a far superior option to the stamped steel cover "performance" clutches on the market.



ST-246 Twin Disc
Street Clutch

Sanctioning Body Rules: If you are selecting a clutch for use in a sanctioned racing series, you will want to start by checking the clutch rule of the sanctioning body. Most sanctioning body rules specify a minimum clutch diameter. The minimum clutch diameter rule is based on the diameter of the friction/driven discs, not the diameter of the entire clutch. This rule keeps the mass moment-of-inertia to a minimum. In addition, rules typically specify acceptable clutch friction materials. Racing clutch friction materials, as far as racing sanctioning body rules are concerned, are divided into two categories: metallic and carbon/carbon.

Clutch Performance Limits

Torque Capacity: Torque capacity refers to the engine torque that the clutch will hold before slippage occurs. Torque capacity ratings among clutch manufacturers cannot be directly compared. Clutch manufacturers do not have an industry standard with which they set clutch torque ratings. Generally, a Tilton OT-Series clutch does not slip until the torque is 50% above the rated torque capacity, making the rating rather conservative. On the other hand, another clutch manufacturer may rate a clutch at the torque level it starts to slip in an effort to provide a more impressive rating. One can usually use the torque ratings to compare clutches from the same manufacturer, but not from different manufacturers.

Heat Capacity: Heat capacity refers to the amount of heat the clutch can withstand before damage or failure occurs. Heat is generated every time the clutch is engaged (slipped/modulated). The heat generated during engagement is mostly absorbed by the clutch's pressure plate, floater plates and discs. Some heat is also absorbed by the flywheel. The more mass a clutch has, the more heat/temperature it can absorb. As with brakes and tires, higher temperatures do more damage. Same is true with clutches. A clutch with an extra disc will have better heat capacity due to the increased mass, exposing the clutch to lower overall temperatures. Due to its stability under heat, carbon/carbon has the ability to withstand the highest temperatures before being damaged. The racetrack is usually easy on the clutch. It is the paddock (or street) where the clutch must be slipped, raising clutch temperature and causing the most damage. In addition, even if horsepower levels are equal, a heavier car will require more material (to absorb heat) than a lighter car.

Durability: Refers to the service life of the clutch. A smaller diameter clutch, or removing a plate from the clutch, will offer increased performance through a lower inertia. Adding a plate to the clutch, or increasing the diameter of the clutch, will increase the life of the clutch due an increased surface area to wear against. In summary, there is a trade-off to be made between clutch weight and maintenance intervals.

Release Load: Force required on the diaphragm spring to disengage the clutch. Lower release loads put less stress on the engine's thrust bearings and reduces pedal effort.

Clamp Load: Force applied by the clutch's diaphragm spring onto the driven plates.

Diaphragm Spring: The Belleville spring located in the clutch cover.

Driven Plate(s): The plate(s) within the clutch assembly that drive the transmission's input shaft.

Pressure Plate: The plate directly under the clutch's diaphragm spring, containing the fulcrum point where clamp load is placed onto the driven plates. Many Tilton OT-Series clutches are available with two pressure plate ratio options, High or Ultra-High.

Floater Plate: The plate(s) that separate the driven discs on multi-plate clutches.





Tilton has applied their nearly 50 years of experience in racing clutches to develop the ST-246 line of 246mm (9.7") twin disc clutch kits for the high-performance street market. Unlike many of the "performance clutches" on the market, ST-246 clutches were engineered from the ground up as a true performance twin disc clutch and not an OEM-type stamped steel pressure plate with a floater plate added. ST-246 clutches are designed to provide high torque capacity, low wear rate, smooth shifting and good drivability. All ST-246 twin disc clutch kits include a billet chromoly steel flywheel and are available with either sprung-hub organic discs (**850 lb-ft capacity**) or solid-hub cerametallic discs (**1250 lb-ft capacity**).

Features

- ▶ Precision machined aluminum clutch cover provides high-strength, stiffness and better dynamic balance than OE-type stamped steel covers.
- ▶ High-mass main pressure plate and floater plate, machined from the same proprietary material as used in Tilton's racing clutches, provides high heat capacity and resists.
- ▶ Heavy-duty straps attach pressure plate and floater plate to the clutch cover, minimizing noise and providing fast & clean release between shifts.
- ▶ Chromoly steel flywheel provides high-strength and long-term durability. Features a precision register to locate the clutch and provide optimal balance (as opposed to loose fitting bolts & dowels used with stamped steel clutches).
- ▶ Weight and inertia engineered to provide a good balance of performance and drivability.
- ▶ 246mm sprung-hub organic disc (**850 lb-ft**) and solid-hub cerametallic disc (**1250 lb-ft**) options.

Car Specific Applications

Includes: Clutch, discs, flywheel, clutch & flywheel bolts, alignment tool and spline grease.

Application	Weight (lbs)	Organic Disc Kits	Cerametallic Disc Kit
Chevy Camaro GEN6	48.3	55-1000	55-2000
Chevy Camaro GEN5	46.4	55-1005*	55-2005*
Chevy Corvette C7	48.3	55-1000	55-2000
Chevy Corvette C6	46.4	55-1009*	55-2009*
Chevy Corvette C5	46.4	55-1004	55-2004

** Includes 6000-Series hydraulic release bearing*



Engine/Transmission Applications

Engine	Transmission	Weight (lbs)	Organic Disc Kits	Cerametallic Disc Kit
Chevy LS (6-Bolt)	Tremec T56 6-spd/ TKO 5-spd (26-spline)	46.4	55-1004	55-2004
Chevy LSA/LSX (8-Bolt)	Tremec T56 6-spd/ TKO 5-spd (26-spline)	46.4	55-1008	55-2008
Chevy LT1/LT4	Tremec T56 6-spd/ TKO 5-spd (26-spline)	46.4	55-1008	55-2008
Chevy V8 (early)*	Tremec T56 6-spd/ TKO 5-spd (26-spline)	43.4	55-1002	55-2002
Ford Coyote	Tremec T56 6-spd/ TKO 5-spd (26-spline)	47.7	55-1001	55-2001
Ford Small Block*	Tremec T56 6-spd/ TKO 5-spd (26-spline)	44.0	55-1003	55-2003

** Internal Balance*



Typical Applications

- Circle Track
- Road Racing



Features

- Tilton's value-oriented 5.5" racing clutch
- Rigid clutch cover design resists deflection
- Hardened steel thrust buttons in clutch cover legs provide long term durability
- Accepts Tilton and QM 110-tooth cover-mount ring gears
- Direct replacement for QM 8-leg 5.5" Clutches
- 750 lb-ft capacity for a 3-plate clutch. 500 lb-ft capacity for 2-plate clutch

SPORT 5.5 Button Clutch Assemblies

Includes: Clutch, discs, button flywheel, clutch bolts and flywheel bolts

Description	Chevy Early	Chevy Crate	Chevy LS	Ford Small Block
2-disc, 26 spline	57-2136	57-2336	57-2436	57-2536
3-disc, 26-spline	57-1136	57-1336	57-1436	57-1536

SPORT 5.5 Service Parts

Clutch Assemblies

Includes: Clutch and disc pack

Description	Part Number
SPORT 5.5 clutch, 2 disc, 26-spline	67-902HG-36
SPORT 5.5 clutch, 3 disc, 26-spline	67-903HG-36

Button Flywheel

Description	Part Number
Button, 8-leg 5.5", Chevy Early	19002
Button, 8-leg 5.5", Chevy Crate, balanced	19023
Button, 8-leg 5.5", Chevy LS	19044
Button, 8-leg 5.5", Ford Small Block	19045

Disc Packs

Description	Part Number
Disc pack, 2-disc, 26-spline	64140-1-AA-36
Disc pack, 3-disc, 26-spline	64140-1-ABA-36

Clutch Service Parts

Description	Part Number
Pressure Plate	67-118HR
Floater Plate	67-119
Clutch Bolt Kit (3 or 2 disc with RG spacer)	95-035



Typical Applications

- Circle Track
- Road Racing



Features

- Tilton's lightest 5.5" racing clutch
- Rigid clutch cover design resists deflection
- Hardened steel thrust buttons in clutch cover legs provide long-term durability
- Accepts Tilton and QM 99 tooth & 110-tooth cover mount ring gears
- Direct replacement for QM 6-leg 5.5" clutches
- 750 lb-ft capacity for 3-plate clutch. 500 lb-ft capacity for 2-plate clutch

ULTRA 5.5 Button Clutch Assemblies

Includes: Clutch, discs, button flywheel, clutch bolts and flywheel bolts

Description	Chevy Early	Chevy Crate	Chevy LS	Ford Small Block
2-disc, 26 spline	57-4136	57-4336	57-4436	57-4536
3-disc, 26-spline	57-3136	57-3336	57-3436	57-3536

ULTRA 5.5 Service Parts

Clutch Assemblies

Includes: Clutch and disc pack

Description	Part Number
ULTRA 5.5 clutch, 2 disc, 26-spline	67-202HG-36
ULTRA 5.5 clutch, 3 disc, 26-spline	67-203HG-36

Button Flywheel

Description	Part Number
Button, 8-leg 5.5", Chevy Early	19038
Button, 8-leg 5.5", Chevy Crate, balanced	19042
Button, 8-leg 5.5", Chevy LS	19041
Button, 8-leg 5.5", Ford Small Block	19043

Disc Packs

Description	Part Number
Disc pack, 2-disc, 26-spline	64140-1-AA-36
Disc pack, 3-disc, 26-spline	64140-1-ABA-36

Clutch Service Parts

Description	Part Number
Pressure Plate	67-128HR
Floater Plate	67-129
Clutch Bolt Kit (3 or 2 disc with RG spacer)	95-036



In 1986, Tilton Engineering introduced its first OT-Series clutch. The “open type” design of OT-Series clutches provided lower operating temperatures and cleaner operation when compared to the “closed type” clutches that were the standard at the time.

Today, Tilton OT-Series clutches have grown to become some of the most widely used and successful clutches in racing. On any given weekend, Tilton OT-Series clutches can be found winning races, from the local racetrack to world renowned racing circuits. They have earned a reputation for providing the level quality, performance and reliability needed to win championships.

OT-Series metallic clutches offer the low weight, low inertia, torque capacity and strength needed for the most demanding racing applications. OT-Series clutches are available in 5.5” and 7.25” diameters, with 1 to 4 friction discs and multiple diaphragm spring rate options to suit a wide range of applications.

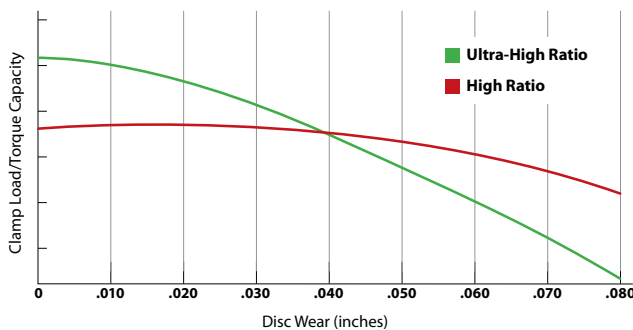

High Ratio Pressure Plate

- Standard pressure plate ratio for 5.5” & 7.25” clutches
- Short release travel for quick engagement and shifting
- Flat clamp load curve for longest wear range

Ultra-High Ratio Pressure Plate

- Optional pressure plate ratio for 7.25” clutches
- 20% more release travel than High Ratio for improved modulation
- 20% more clamp load than High Ratio for higher peak torque capacity
- Clamp load drops more quickly with wear than High Ratio

Features

Open, one-piece clutch cover design provides lower operating temperature, high strength and minimal deflection for quick shifting.

Chrome vanadium diaphragm springs and an engineered pressure plate geometry provide a high clamp load-to-wear ratio, low release load and quick shifting.

High-strength steel is used in both the pressure plates and the floater plates.

.104”-thick friction disc withstands elevated temperatures while providing low inertia and excellent wear resistance.

Hardened steel thrust buttons provide smooth and durable surface for pressure and floater plates.

Every Tilton OT clutch is dynamically balanced to ensure the highest level of performance.

Each OT clutch is individually inspected for proper assembly and balance, and initialed by the quality personnel as confirmation.

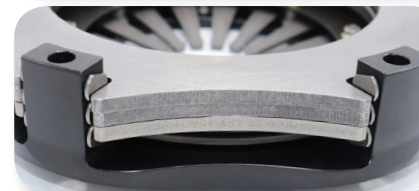



Typical Applications

- Circle Track
- Road Racing
- Open Wheel/Formula
- Drifting
- Off-Road

Features

- Disc Diameter: 7.25" (185mm)
- Disc Count: 1, 2, 3, 4-disc
- Pressure Plate Ratios: High, Ultra-High
- Diaphragm Spring Rates: W, BF, ORA, G, GG, GGG
- Option: Heavy Duty model features high-mass pressure plate that provides additional heat capacity for severe applications

Weight & Inertia

Clutch	Weight (lbs/kg)	Inertia (lb-in ² /kg-m ²)
1 Disc	5.1/2.3	44.1/.0130
2 Disc	7.5/3.4	66.3/.0195
3 Disc	9.9/4.5	87.6/.0258
3 Disc Heavy Duty	10.6/4.8	94.6/.0278
4 Disc	10.6/4.8	94.6/.0278
4 Disc Heavy Duty	13.0/5.9	115.9/.0340



Clutch Service Parts

Description	Part Number
Pressure Plate, High Ratio	66-118HR
Pressure Plate, Ultra High Ratio	66-118UHR
Pressure Plate, High Ratio, Heavy Duty	66-158HR
Floater Plate	66-119

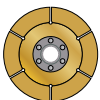

See page 19-20 for available clutch disc packs options

Installation drawing for OT-II 7.25" Metallic Clutches is available at www.tiltonracing.com/technical/installation-drawings



	Pressure Plate	Diaphragm Spring	Torque Capacity (lb-ft/Nm)	Release Load (lb/daN)	Part Number
1-Disc	High	W	200/272	400/180	66-001HW
	High	BF	240/326	480/211	66-001HBF
	High	ORA	280/381	560/247	66-001HORA
	High	G	340/462	680/299	66-001HG
	High	GG	380/517	760/334	66-001HGG
	Ultra High	W	240/326	400/180	66-001UW
	Ultra High	BF	285/388	480/211	66-001UBF
	Ultra High	ORA	335/456	560/247	66-001UORA
	Ultra High	G	380/517	680/299	66-001UG
	Ultra High	GG	455/619	760/334	66-001UGG
2-Disc	High	W	400/544	400/180	66-002HW
	High	BF	480/652	480/211	66-002HBF
	High	ORA	560/762	560/247	66-002HORA
	High	G	680/925	680/299	66-002HG
	High	GG	760/925	760/334	66-002HGG
	Ultra High	W	480/652	400/180	66-002UW
	Ultra High	BF	570/775	480/211	66-002UBF
	Ultra High	ORA	670/911	560/247	66-002UORA
	Ultra High	G	820/1115	680/299	66-002UG
	Ultra High	GG	910/1238	760/334	66-002UGG
3-Disc	High	W	600/816	400/180	66-003HW
	High	BF	720/979	480/211	66-003HBF
	High	ORA	840/1142	560/247	66-003HORA
	High	G	1020/1387	680/299	66-003HG
	High	GG	1140/1550	760/334	66-003HGG
	High	GGG	1245/1693	800/330	66-003HGGG
	Ultra High	W	720/978	400/180	66-003UW
	Ultra High	BF	855/1164	480/211	66-003UBF
	Ultra High	ORA	1005/1368	560/247	66-003UORA
	Ultra High	G	1140/1551	680/299	66-003UG
Ultra High	GG	1365/1857	760/334	66-003UGG	
3-Disc Heavy Duty	High	ORA	840/1142	560/247	66-503HORA
	High	G	1020/1387	680/299	66-503HG
	High	GG	1140/1550	760/334	66-503HGG
	High	GGG	1245/1693	800/352	66-503HGGG
4-Disc Heavy Duty	High	ORA	1120/1523	560/247	66-504HORA
	High	G	1360/1850	680/299	66-504HG
	High	GG	1520/2067	760/334	66-504HGG
	High	GGG	1660/2257	800/352	66-504HGGG

Notes:

- Unless noted, clutches are designed for the use with flywheels that have a .100" (2.54mm) step for the friction surface to register the clutch by the ID of the clutch cover legs. Contact Tilton for options available for "pot type" flywheels.
- Weight and inertia values listed include friction discs (sold separately)
- Release load values listed are based on the use of a release bearing with 44mm contact diameter. Larger contact diameter will increase release load.

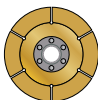

See page 19-20 for available clutch disc packs options

Installation drawing for OT-II 7.25" Metallic Clutches is available at www.tiltonracing.com/technical/installation-drawings

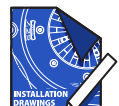



Typical Applications

- Road Racing
- Open Wheel/Formula
- Circle Track
- Endurance

Features

- Disc Diameter: 5.5" (140mm)
- Disc Count: 1, 2, 3, 4-disc
- Pressure Plate Ratios: High
- Diaphragm Spring Rates: W, ORA, G
- Option: Heavy Duty model features high-mass pressure plate that provides additional heat capacity for severe applications.

Weight & Inertia

Clutch	Weight (lbs/kg)	Inertia (lb-in ² /kg-m ²)
1 Disc	4.1/1.9	19.5/0.0057
2 Disc	5.7/2.6	29.8/0.0087
3 Disc	7.3/3.3	40.1/0.0118
3 Disc Heavy Duty	7.7/3.5	42.4/0.0125
4 Disc	8.9/4.0	50.4/0.0148
4 Disc Heavy Duty	9.3/4.2	52.7/0.0154



Clutch Service Parts

Description	Part Number
Pressure Plate, High Ratio	67-118HR
Pressure Plate, High Ratio, Heavy Duty	67-158HR*
Floater Plate	67-119
Floater Plate, Heavy Duty	67-159*

**Only fits Heavy Duty version of 5.5" clutches. Cannot be installed into standard 5.5" clutches.*

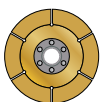

See page 21-22 for available clutch disc packs options

Installation drawing for OT-III 5.5" Metallic Clutches is available at www.tiltonracing.com/technical/installation-drawings

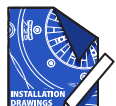

Disc Count	Pressure Plate	Diaphragm Spring	Flywheel Type	Torque Capacity (lb-ft/Nm)	Release Load (lb/daN)	Part Number
	1-Disc	High	W	Step	150/204	480/211
High		ORA	Step	200/272	510/225	67-001HORA
High		G	Step	250/340	850/375	67-001HG
Disc Count	Pressure Plate	Diaphragm Spring	Flywheel Type	Torque Capacity (lb-ft/Nm)	Release Load (lb/daN)	Part Number
	2-Disc	High	W	Step	300/408	480/211
High		ORA	Step	400/544	510/225	67-002HORA
High		G	Step	500/680	850/375	67-002HG
Disc Count	Pressure Plate	Diaphragm Spring	Flywheel Type	Torque Capacity (lb-ft/Nm)	Release Load (lb/daN)	Part Number
	3-Disc	High	W	Step	450/612	480/211
High		W	Pot	450/612	480/211	67-013HW
High		ORA	Step	600/816	600/816	67-003HORA
High		ORA	Pot	600/816	600/816	67-013HORA
High		G	Step	750/1020	850/375	67-003HG
High		G	Pot	750/1020	850/375	67-013HG
Disc Count	Pressure Plate	Diaphragm Spring	Flywheel Type	Torque Capacity (lb-ft/Nm)	Release Load (lb/daN)	Part Number
	3-Disc Heavy Duty	High	W	Step	450/612	480/211
High		W	Pot	450/612	480/211	67-513HW
High		ORA	Step	600/816	510/225	67-503HORA
High		ORA	Pot	600/816	510/225	67-513HORA
High		G	Step	750/1020	850/375	67-503HG
High		G	Pot	750/1020	850/375	67-513HG
Disc Count	Pressure Plate	Diaphragm Spring	Flywheel Type	Torque Capacity (lb-ft/Nm)	Release Load (lb/daN)	Part Number
	4-Disc	High	ORA	Step	800/1088	510/225
High		ORA	Pot	800/1088	510/225	67-014HORA
High		G	Step	1000/1360	850/375	67-004HG
High		G	Pot	1000/1360	850/375	67-014HG
Disc Count	Pressure Plate	Diaphragm Spring	Flywheel Type	Torque Capacity (lb-ft/Nm)	Release Load (lb/daN)	Part Number
	4-Disc Heavy Duty	High	ORA	Step	800/1088	510/225
High		ORA	Pot	800/1088	510/225	67-514HORA
High		G	Step	1000/1360	850/375	67-504HG
High		G	Pot	1000/1360	850/375	67-514HG

Notes:

- Unless noted, clutches are designed for the use with flywheels that have a .100" (2.54mm) step for the friction surface to register the clutch by the ID of the clutch cover legs. Contact Tilton for options available for "pot type" flywheels.
- Weight and inertia values listed include friction discs (sold separately)
- Release load values listed are based on the use of a release bearing with 38mm contact diameter. Larger contact diameter will increase release load.

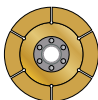

See page 21-22 for available clutch disc packs options

Installation drawing for OT-III 5.5" Metallic Clutches is available at www.tiltonracing.com/technical/installation-drawings

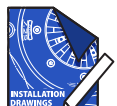

Features



Open, one-piece clutch cover design provides lower operating temperature, high strength and minimal deflection for quick shifting.



Chrome vanadium diaphragm springs and an engineered pressure plate geometry provide a high clamp load-to-wear ratio, low release load and quick shifting.



High-strength steel is used in both the pressure plates and the floater plates.

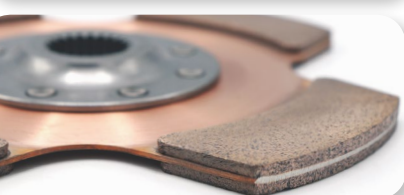

.283"-thick friction disc withstands elevated temperatures while providing low inertia and excellent wear resistance.



Hardened steel thrust buttons provide smooth and durable surface for pressure and floater plates.



Every Tilton OT clutch is dynamically balanced to ensure the highest level of performance.

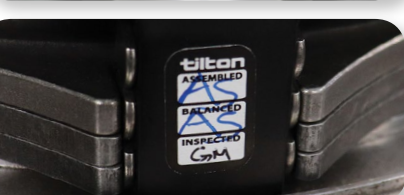

Each OT clutch is individually inspected for proper assembly and balance, and initialed by the quality personnel as confirmation.



Tilton OT-Series cerametallic clutches share many of the same features with OT-Series metallic clutches, but feature thicker friction discs that utilize a unique blend of ceramic and metallic materials. The engagement characteristics of the cerametallic discs provide smoother engagement characteristics than metallic discs, making them a good choice for applications that require some clutch modulation (such as rally, hill climb and autocross). In addition, the thicker friction discs provide a higher heat capacity than metallic discs due to the increased mass they provide.

OT-Series cerametallic clutches offer the low weight, low inertia, torque capacity and the strength needed for the most demanding racing applications. OT-Series cerametallic clutches are available in 7.25" diameter, with 1 or 2 friction discs and multiple diaphragm spring rate options to suit a wide range of applications.

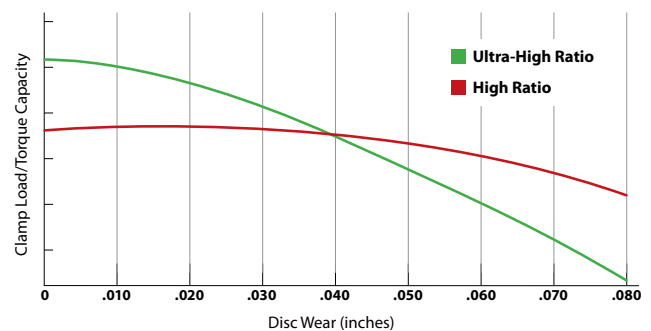

High Ratio Pressure Plate

- Short release travel for quick engagement and shifting
- Flat clamp load curve for longest wear range

Ultra-High Ratio Pressure Plate

- 20% more release travel than High Ratio for improved modulation
- 20% more clamp load than High Ratio for higher peak torque capacity
- Clamp load drops more quickly with wear than High Ratio



Features

- Disc Diameter: 7.25" (185mm)
- Disc Count: 1, 2-disc
- Pressure Plate Ratios: High, Ultra-High
- Diaphragm Spring Rates: W, BF, ORA, G, GG, GGG

Weight & Inertia

Clutch	Weight (lbs/kg)	Inertia (lb-in ² /kg-m ²)
1 Disc	5.6/2.5	52.4/.0154
2 Disc	8.2/3.7	76.3/.0225

Clutch Service Parts

Description	Part Number
Pressure Plate, High Ratio	66-118HR-R
Pressure Plate, Ultra High Ratio	66-118UHR-R
Floater Plate	66-119

Typical Applications

- Rally
- Club Racing
- Road Racing
- Import Drag Racing
- Off-Road

1-Disc	Pressure Plate	Diaphragm Spring	Torque Capacity (lb-ft/Nm)	Release Load (lb/daN)	Part Number
	High	W	200/272	400/180	66-301HW
	High	BF	240/326	480/211	66-301HBF
	High	ORA	280/381	560/247	66-301HORA
	High	G	340/462	680/299	66-301HG
	High	GG	380/517	760/334	66-301HGG
	Ultra High	W	240/326	400/180	66-301UW
	Ultra High	BF	285/388	480/211	66-301UBF
	Ultra High	ORA	335/456	560/247	66-301UORA
	Ultra High	G	380/517	680/299	66-301UG
Ultra High	GG	455/619	760/334	66-301UGG	
2-Disc	Pressure Plate	Diaphragm Spring	Torque Capacity (lb-ft/Nm)	Release Load (lb/daN)	Part Number
	High	W	400/544	400/180	66-302HW
	High	BF	480/652	480/211	66-302HBF
	High	ORA	560/762	560/247	66-302HORA
	High	G	680/925	680/299	66-302HG
	High	GG	760/925	760/334	66-302HGG
	Ultra High	W	480/652	400/180	66-302UW
	Ultra High	BF	570/775	480/211	66-302UBF
	Ultra High	ORA	670/911	560/247	66-302UORA
	Ultra High	G	820/1115	680/299	66-302UG
Ultra High	GG	910/1238	760/334	66-302UGG	

Notes:

- Unless noted, clutches are designed for the use with flywheels that have a .100" (2.54mm) step for the friction surface to register the clutch by the ID of the clutch cover legs. Contact Tilton for options available for "pot type" flywheels.
- Weight and inertia values listed include friction discs (sold separately)
- Release load values listed are based on the use of a release bearing with 44mm contact diameter. Larger contact diameter will increase release load.

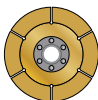

See page 18 for available clutch disc packs options

Installation drawing for OT-II 7.25" Ceramic Metallic Clutches is available at www.tiltonracing.com/technical/installation-drawings



Features



Open, one-piece clutch cover design provides lower operating temperature, high strength and minimal deflection for quick shifting.

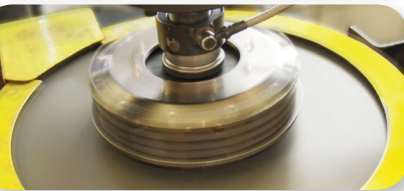

Individually clamp-load and dyno-tested before shipping.



Each clutch is assigned a unique serial number to clutch history through the Tilton database.



Steel pressure plate/shims are available in varying thicknesses, enabling customers to service clutches as carbon stack wears.

Pressure Plate Options

OT-Series carbon/carbon clutches are available in 4.5", 5.5" & 7.25" diameters, with 1 to 4 discs and multiple diaphragm spring rate options to suit a wide range of applications.

High Ratio Pressure Plate

- Standard pressure plate ratio for 4.5"/5.5" carbon clutches
- Short release travel for quick engagement and shifting
- Flat clamp load curve for longest wear range

Ultra-High Ratio Pressure Plate

- Optional pressure plate ratio for [5.5" carbon clutches](#).
- Standard pressure plate ratio for [7.25" carbon clutches](#).
- 20% more release travel than High Ratio for improved modulation
- 20% more clamp load than High Ratio for higher peak torque capacity
- Clamp load drops more quickly with wear than High Ratio

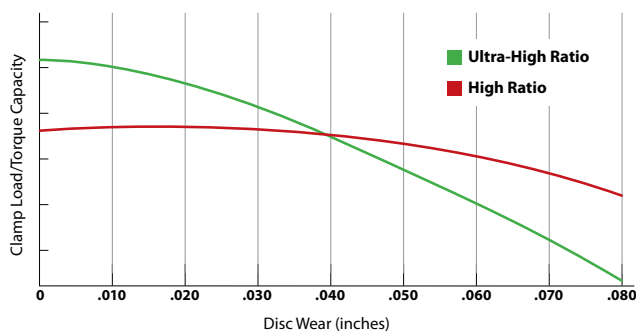

Tilton Engineering invented the carbon/carbon racing clutch and patented the drive system in the mid-80's. It was the first carbon/carbon clutch ever to win a Formula One Grand Prix (Ayrton Senna's Lotus-Honda at the 1987 US Grand Prix in Detroit). Since then, Tilton OT-Series carbon clutches have been continually refined to be the best on the market.

Utilizing the experience Tilton has gained over the 40 plus years, OT-Series carbon/carbon clutches have evolved to be second to none in quality. Each is built using the finest materials and the latest manufacturing processes while holding to strict quality control standards. As part of their build process, OT-Series carbon clutches are rigorously tested and documented before being delivered to the customer.

Tilton OT-Series carbon clutches offer a unique combination of an extremely low inertia, high torque capacity, high heat capacity and smooth engagement characteristics. Because of these features, they can be found used in road racing, endurance racing, off-road and high-performance street applications.

The carbon matrix plates (driven & floater) do not warp from heat, providing consistent shifting and minimizing heat-related clutch failures. The smooth engagement characteristics of the carbon plates provide good drivability and reduce "shock" to other driveline components. Through the use of additional pressure plates (shims) and periodic rebuilds, OT-Series carbon/carbon clutches offer long life under extreme-performance conditions.



Features

- Disc Diameter: 7.25" (185mm)
- Disc Count: 2, 3, 4-disc
- Pressure Plate Ratios: Ultra-High
- Diaphragm Spring Rates: ORA, G, GG, GGG

Weight & Inertia

Clutch	Weight (lbs/kg)	Inertia (lb-in ² /kg-m ²)
2 Disc	6.2/2.8	52.8/.0155
3 Disc	7.6/3.4	63.7/.0186
4 Disc	9.1/4.1	74.9/.0219

Typical Applications

- Road Racing
- Endurance
- Rally/Rallycross
- Extreme Street
- Hill Climb
- Short Course Off-Road

2-Disc	Diaphragm Spring	Torque Capacity (lb-ft/Nm)	Release Load (lb/daN)	Part Number (Step-type Flywheel)	Part Number (Pot-type Flywheel)
	ORA	670/911	560/247	6572USORA-S	6572USORA-P
	G	820/1115	680/299	6572USG-S	6572USG-P
	GG	910/1238	760/334	6572USGG-S	6572USGG-P
	GGG	990/1347	800/352	6572USGGG-S	6572USGGG-P
3-Disc	Diaphragm Spring	Torque Capacity (lb-ft/Nm)	Release Load (lb/daN)	Part Number (Step-type Flywheel)	Part Number (Pot-type Flywheel)
	ORA	1005/1367	560/247	6573USORA-S	6573USORA-P
	G	1230/1673	680/299	6573USG-S	6573USG-P
	GG	1365/1856	760/334	6573USGG-S	6573USGG-P
	GGG	1485/2020	800/352	6573USGGG-S	6573USGGG-P
4-Disc	Diaphragm Spring	Torque Capacity (lb-ft/Nm)	Release Load (lb/daN)	Part Number (Step-type Flywheel)	Part Number (Pot-type Flywheel)
	ORA	1340/1823	560/247	6574USORA-S	6574USORA-P
	G	1640/2230	680/299	6574USG-S	6574USG-P
	GG	1820/2475	760/334	6574USGG-S	6574USGG-P
	GGG	1980/2693	800/352	6574USGGG-S	6574USGGG-P

Notes:

- Clutch includes .360" pressure plate and drive hub (designate spline size when ordering)
- Release load values listed are based on the use of a release bearing with 44mm contact diameter. Larger contact diameter will increase release load.

Pressure Plates (wear compensating shims)

Tilton offers a range of pressure plate thickness that are designed to compensate for carbon stack wear and maintain optimal clutch torque capacity. Pressure plates are available in .010" increments, .360" to .500" thick. For a list of parts numbers, please visit www.tiltonracing.com/product/7-25-inch-carbon-clutch-pressure-plates.

Installation drawing for OT-II 7.25" Carbon/Carbon Clutches is available at www.tiltonracing.com/technical/installation-drawings





Features

- Disc Diameter: 5.5" (140mm)
- Disc Count: 2, 3, 4-Disc
- Pressure Plate Ratios: High, Ultra-High
- Diaphragm Spring Rates: ORA, G

Weight & Inertia

Clutch	Weight (lbs/kg)	Inertia (lb-in ² /kg-m ²)
2 Disc	3.7/1.7	17.8/0052
3 Disc	4.4/2.0	22.0/0065
4 Disc	5.2/2.3	25.3/0074

Typical Applications

- Road Racing
- Endurance
- Open Wheel/Formula

	Diaphragm Spring	Pressure Plate Ratio	Torque Capacity (lb-ft/Nm)	Release Load (lb/daN)	Part Number (Step-type Flywheel)	Part Number (Pot-type Flywheel)
2-Disc	ORA	High	400/272	480/211	6552HSORA-S	6552HSORA-P
	G	High	500/680	850/375	6552HSG-S	6552HSG-P
	ORA	Ultra High	480/652	480/211	6552USORA-S	6552USORA-P
	G	Ultra High	600/816	850/375	6552USG-S	6552USG-P
3-Disc	ORA	High	600/816	480/211	6553HSORA-S	6553HSORA-P
	G	High	750/928	850/375	6553HSG-S	6553HSG-P
	ORA	Ultra High	720/928	480/211	6553USORA-S	6553USORA-P
	G	Ultra High	900/1224	850/375	6553USG-S	6553USG-P
4-Disc	ORA	High	800/1088	480/211	6554HSORA-S	6554HSORA-P
	G	High	1000/1360	850/375	6554HSG-S	6554HSG-P
	ORA	Ultra High	960/1324	480/211	6554USORA-S	6554USORA-P
	G	Ultra High	1200/1632	850/375	6554USG-S	6554USG-P

Notes:

- Clutch includes .187" pressure plate and drive hub (designate spline size when ordering)
- Release load values listed are based on the use of a release bearing with 38mm contact diameter. Larger contact diameter will increase release load.

Pressure Plates (wear compensating shims)

Tilton offers a range of pressure plate thickness that are designed to compensate for carbon stack wear and maintain optimal clutch torque capacity. Pressure plates are available in .010" increments, .187" to .307" thick. For a list of parts numbers, please visit www.tiltonracing.com/product/5-5-inch-carbon-clutch-pressure-plates.





Features

- ▶ Disc Diameter: 4.5" (114mm)
- ▶ Disc Count: 3, 4-disc
- ▶ Pressure Plate Ratios: High
- ▶ Diaphragm Spring Rates: G

Weight & Inertia

Clutch	Weight (lbs/kg)	Inertia (lb-in ² /kg-m ²)
3 Disc	3.2/1.5	12.3/0.036
4 Disc	3.8/1.8	13.0/0.038

Typical Applications

- ▶ Road Racing
- ▶ Open Wheel/Formula

3-Disc	Flywheel Type	Pressure Plate Ratio	Torque Capacity (lb-ft/Nm)	Release Load (lb/daN)	Part Number
	Pot-type	High	690/938	800/352	6513HSG-P
Step-type	High	690/938	800/352	6513HSG-S	
4-Disc	Flywheel Type	Pressure Plate Ratio	Torque Capacity (lb-ft/Nm)	Release Load (lb/daN)	Part Number
	Pot-type	High	920/1251	800/352	6514HSG-P
Step-type	High	920/1251	800/352	6514HSG-S	

Notes:

- Clutch includes .160" pressure plate and drive hub (designate spline size when ordering)
- Release load values listed are based on the use of a release bearing with 38mm contact diameter. Larger contact diameter will increase release load.

Pressure Plates (wear compensating shims)

Tilton offers a range of pressure plate thickness that are designed to compensate for carbon stack wear and maintain optimal clutch torque capacity. Pressure plates are available in .010" increments, .160" to .310" thick.

Thickness	Part Number	Thickness	Part Number
.160"	651-118H-160S	.240"	651-118H-240S
.170"	651-118H-170S	.250"	651-118H-250S
.180"	651-118H-180S	.260"	651-118H-260S
.190"	651-118H-190S	.270"	651-118H-270S
.200"	651-118H-200S	.280"	651-118H-280S
.210"	651-118H-210S	.290"	651-118H-290S
.220"	651-118H-220S	.300"	651-118H-300S
.230"	651-118H-230S	.310"	651-118H-310S

Installation drawing for OT-V 4.5" Carbon/Carbon Clutches is available at www.tiltonracing.com/technical/installation-drawings



Tilton Engineering offers a large selection of disc packs for OT-Series clutches. Every Tilton disc pack benefits from over 30 years of experience in friction material testing and development. The result is disc packs that offer the highest levels of performance and durability.

The proceeding pages contains information on disc packs for popular applications. Due to the wide variety of transmission input fast size and lengths, disc pack configurations can vary significantly with multi-plate clutches. If you do not see your application listed, please contact Tilton Engineering for information and part numbers.

Part Number System

Example:

64185-2-ABA-36

Product Class

Disc Diameter

Material Type

Hub Configuration

Spline Size

Disc Diameter:
140 = 140mm (5.5")
185 = 185mm (7.25")

Friction Material/Type:
2 = 7.25" sintered metallic full-circle disc (6-rivet hub)
3 = 5.5" & 7.25" sintered metallic paddle-type disc
4 = 7.25" sintered ,metallic full circle disc (8-rivet hub)
8 = 7.25" cerametallic paddle-type disc
9 = 5.5" sintered metallic full-circle disc

Hub Type:
A = Outer hub, 6-rivet, .375" thick
B = Inner hub, 6-rivet, .375" thick
C = Inner hub, rivet, .250" thick
F = Long hub, 6-rivet, .550" thick (1-disc clutches only)
H = Outer hub, nested 12-rivet
J = Inner hub, nested, 12-rivet
R = Inner hub, 8-rivet, .250" thick
T = Inner Hub, 8-rivet, .375" thick
V = Outer hub, 8-rivet, .375" thick
W = Long hub, 8-rivet, .550" thick (1-disc clutches only)

Spline Size (# teeth x diameter)		
03 = 10 x 7/8"	18 = 18 x 25/32"	36 = 26 x 15/32"
04 = 10 x 1"	19 = 18 x 1 3/16"	38 = 24 x 26mm
05 = 10 x 1 1/16"	25 = 20 x 7/8"	39 = 28 x 7/8"
06 = 10 x 1 1/8"	26 = 21 x 29/32"	41 = 23 x 24mm x 25°
07 = 10 x 1 1/4"	27 = 21 x 24mm	42 = 22 x 15/16"
08 = 10 x 1 3/8"	28 = 21 x 29mm	47 = 24 x 15/16"
10 = 10 x 29mm	29 = 22 x 1"	51 = 22 x 29.4mm
12 = 14x 25mm	30 = 23 x 1" x 30°	52 = 10 x 35mm
14 = 14 x 30.8"	32 = 24 x 13/16"	55 = 26 x 35mm
17 = 18 x 21mm	33 = 24 x 1" x 27.5°	58 = 29 x 1 1/4"

Hub Configuration:

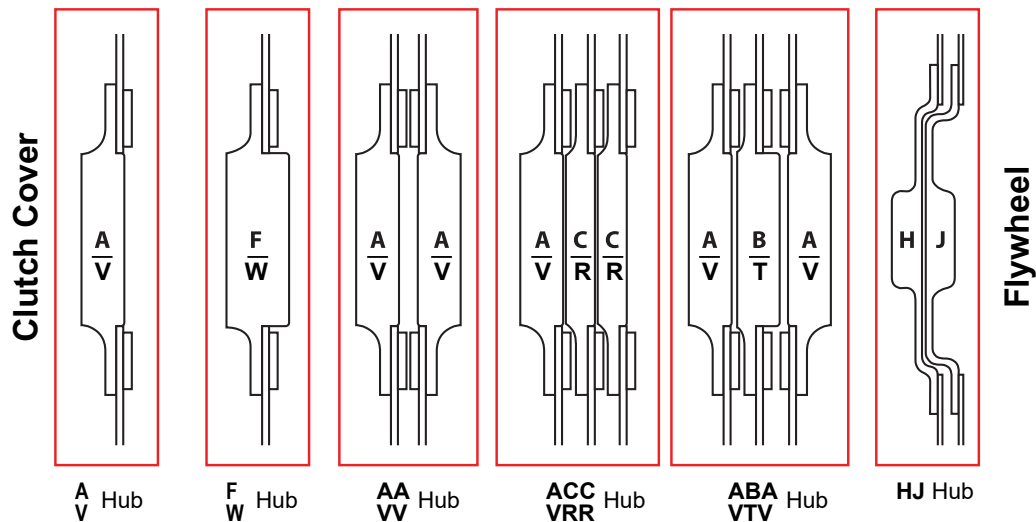

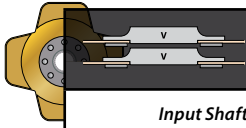

"Back-to-Back" Hub Configuration

PADDLE | 8-rivet

<i>Input Shaft Size (# of teeth x diameter)</i>	<i>1-plate</i>	<i>2-plate</i>
10 x 7/8"	64185-8-V-03	64185-8-VV-03
10 x 1"	64185-8-V-04	64185-8-VV-04
10 x 1 1/16"	64185-8-V-05	64185-8-VV-05
10 x 1 1/8"	64185-8-V-06	64185-8-VV-06
10 x 1 3/8"	64185-8-V-08	64185-8-VV-08
10 x 29mm	64185-8-V-10	64185-8-VV-10
10 x 35mm	64185-8-V-52	64185-8-VV-52
14 x 25mm	64185-8-V-12	64185-8-VV-12
14 x 30.8mm	64185-8-V-14	64185-8-VV-14
18 x 1 3/16"	64185-8-V-19	64185-8-VV-19
20 x 7/8"	64185-8-W-25	64185-8-VV-25
21 x 29/32"	64185-8-V-26	64185-8-VV-26
21 x 24mm	64185-8-V-27	64185-8-VV-27
21 x 29mm	64185-8-V-28	64185-8-VV-28
22 x 15/16"	64185-8-V-42	64185-8-VV-42
22 x 1"	64185-8-V-29	64185-8-VV-29
22 x 29.4mm	64185-8-V-51	64185-8-VV-51
23 x 1" x 30 degree	64185-8-W-30	64185-8-VV-30
23 x 24mm x 25 degree	64185-8-V-41	64185-8-VV-41
24 x 13/16"	64185-8-V-32	64185-8-VV-32
24 x 15/16"	64185-8-V-47	64185-8-VV-47
24 x 1 x 27.5 degree (early Nissan)	64185-8-V-33	64185-8-VV-33
24 x 1 x 30 degree (late Nissan)	64185-8-V-57	64185-8-VV-57
24 x 26mm	64185-8-V-38	64185-8-VV-38
26 x 1 5/32"	64185-8-W-36	64185-8-VV-36
26 x 35mm	64185-8-V-55	64185-8-VV-55
29 x 1 1/4"	64185-8-V-58	64185-8-VV-58

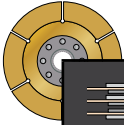

Standard disc that is suitable for most applications.

Six friction pads provide maximum surface area for low wear rate and high heat capacity

FULL CIRCLE | 6-rivet

 "Back-to-Back" Hub Configuration			
Input Shaft Size (# of teeth x diameter)	1-plate	2-plate	3-plate
10 x 7/8"	64185-2-A-03	64185-2-AA-03	N/A
10 x 1"	64185-2-A-04	64185-2-AA-04	N/A
10 x 1 1/4"	64185-2-A-07	64185-2-AA-07	N/A
10 x 1 1/8"	64185-2-A-06	64185-2-AA-06	64185-2-ABA-06
10 x 1 3/8"	64185-2-A-08	64185-2-AA-08	64185-2-ABA-08
10 x 29mm	64185-2-A-10	64185-2-AA-10	64185-2-ABA-10
10 x 35mm	64185-2-A-52	64185-2-AA-52	64185-2-ABA-52
14 x 25mm	64185-2-A-12	64185-2-AA-12	N/A
14 x 30.8mm	64185-2-A-14	64185-2-AA-14	64185-2-ABA-14
18 x 21mm	64185-2-A-17	64185-2-AA-17	N/A
18 x 1 3/16"	64185-2-A-19	64185-2-AA-19	64185-2-ABA-19
20 x 7/8"	64185-2-F-25	64185-2-AA-25	64185-2-ABA-25
21 x 29/32"	64185-2-A-26	64185-2-AA-26	64185-2-ABA-26
21 x 24mm	64185-2-A-27	64185-2-AA-27	N/A
21 x 29mm	64185-2-A-28	64185-2-AA-28	64185-2-ABA-28
22 x 15/16"	64185-2-A-42	64185-2-AA-42	N/A
22 x 1"	64185-2-A-29	64185-2-AA-29	64185-2-ABA-29
22 x 29.4mm	64185-2-A-51	64185-2-AA-51	64185-2-ABA-51
23 x 1" x 30 degree	64185-2-F-30	64185-2-AA-30	64185-2-ABA-30
23 x 24mm x 25 degree	64185-2-A-41	64185-2-AA-41	64185-2-ABA-41
24 x 13/16"	64185-2-A-32	64185-2-AA-32	N/A
24 x 15/16"	64185-2-A-47	64185-2-AA-47	N/A
24 x 1 x 27.5 degree (early Nissan)	64185-2-A-33	64185-2-AA-33	64185-2-ABA-33
24 x 1 x 30 degree (late Nissan)	64185-2-A-57	64185-2-AA-57	64185-2-ABA-57
24 x 26mm	64185-2-A-38	64185-2-AA-38	N/A
26 x 1 5/32"	64185-2-A-36	64185-2-AA-36	64185-2-ABA-36
26 x 35mm	64185-2-A-55	64185-2-AA-55	64185-2-ABA-55
28 x 7/8"	64185-2-A-39	64185-2-AA-39	N/A
29 x 1 1/4"	64185-2-A-58	64185-2-AA-58	64185-2-ABA-58

 "Stacked" Hub Configuration			
Input Shaft Size (# of teeth x diameter)	1-plate	2-plate	3-plate
10 x 1 1/16"	64185-2-A-05	64185-2-AC-05	64185-2-ACC-05
10 x 35 mm	64185-2-A-52	64185-2-AC-52	64185-2-ACC-52
10 x 29mm	64185-2-A-10	64185-2-AC-10	64185-2-ACC-10
18 x 25/32"	64185-2-A-18	64185-2-AC-18	64185-2-ACC-18
20 x 7/8"	64185-2-F-25	64185-2-AC-25	64185-2-ACC-25
21 x 29/32"	64185-2-A-26	64185-2-AC-26	64185-2-ACC-26
23 x 1" x 30 degree	64185-2-F-30	64185-2-AC-30	64185-2-ACC-30
23 x 24mm x 25 degree	64185-2-A-41	64185-2-AC-41	64185-2-ACC-41
24 x 13/16"	64185-2-A-32	64185-2-AC-32	64185-2-ACC-32
24 x 1" (late Nissan)	64185-2-A-57	64185-2-AC-57	64185-2-ACC-57
26 x 22mm	64185-2-A-35	64185-2-AC-35	64185-2-ACC-35
26 x 1 5/32"	64185-2-A-36	64185-2-AC-36	64185-2-ACC-36
26 x 35mm	64185-2-A-55	64185-2-AC-55	64185-2-ACC-55

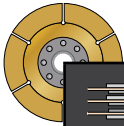

Feature 8-rivet hubs on a larger BCD for additional attachment strength for the most demanding applications.

FULL CIRCLE | 8-rivet

 "Back-to-Back" Hub Configuration				
Input Shaft Size (# of teeth x diameter)	1-plate	2-plate	3-plate	4-plate
10 x 1 1/8"	64185-4-V-06	64185-4-VV-06	64185-4-VTV-06	N/A
10 x 29mm	64185-4-V-10	64185-4-VV-10	64185-4-VTV-10	N/A
10 x 35mm	64185-4-V-52	64185-4-VV-52	64185-4-VTV-52	N/A
20 x 7/8"	64185-4-V-25	64185-4-VV-25	64185-4-VTV-25	N/A
23 x 1" x 30 degree	64185-4-W-30	64185-4-VV-30	64185-4-VTV-30	N/A
23 x 24mm x 25 degree	64185-4-V-41	64185-4-VV-41	N/A	N/A
26 x 1 5/32"	64185-4-V-36	64185-4-VV-36	64185-4-VTV-36	N/A
26 x 35mm	64185-4-V-55	64185-4-VV-55	64185-4-VTV-55	N/A
29 x 1 1/4"	64185-4-V-58	64185-4-VV-58	64185-4-VTV-58	N/A

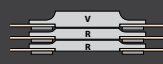
 "Stacked" Hub Configuration				
Input Shaft Size (# of teeth x diameter)	1-plate	2-plate	3-plate	4-plate
10 x 1 1/8"	64185-4-V-06	64185-4-VR-06	64185-4-VRR-06	N/A
10 x 29mm	64185-4-V-10	64185-4-VR-10	64185-4-VRR-10	N/A
14 X 30.8mm	64185-4-V-14	64185-4-VR-14	64185-4-VRR-14	64185-4-VRRR-14
23 x 1" x 30 degree	64185-4-W-30	64185-4-VR-30	64185-4-VRR-30	64185-4-VRRR-30
23 x 24mm x 25 degree	64185-4-V-41	64185-4-VR-41	64185-4-VRR-41	N/A
26 x 1 5/32"	64185-4-V-36	64185-4-VR-36	64185-4-VRR-36	64185-4-VRRR-36
29 x 1 1/4"	64185-4-V-58	64185-4-VR-58	64185-4-VRR-58	64185-4-VRRR-58



Lower inertia than full-circle discs, but have a slightly higher wear rate. Smooth radius between the friction segments also lowers core plate stress cause by misalignment between engine & transmission and/or engine harmonics, resisting core plate cracking.

PADDLE | 8-rivet

 "Back-to-Back" Hub Configuration				
Input Shaft Size (# of teeth x diameter)	1-plate	2-plate	3-plate	4-plate
10 x 1 1/8"	64185-3-V-06	64185-3-VV-06	64185-3-VTV-06	N/A
10 x 29mm	64185-3-V-10	64185-3-VV-10	64185-3-VTV-10	N/A
10 x 35mm	64185-3-V-52	64185-3-VV-52	64185-3-VTV-52	N/A
20 x 7/8"	64185-3-W-25	64185-3-VV-25	64185-3-VTV-25	N/A
23 x 1" x 30 degree	64185-3-V-30	64185-3-VV-30	64185-3-VTV-30	N/A
23 x 24mm x 25 degree	64185-3-V-41	64185-3-VV-41	N/A	N/A
26 x 1 5/32"	64185-3-V-36	64185-3-VV-36	64185-3-VTV-36	N/A
26 x 35mm	64185-3-V-55	64185-3-VV-55	64185-3-VTV-55	N/A
29 x 1 1/4"	64185-3-V-58	64185-3-VV-58	64185-3-VTV-58	N/A

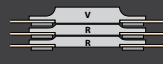
 "Stacked" Hub Configuration				
Input Shaft Size (# of teeth x diameter)	1-plate	2-plate	3-plate	4-plate
10 x 1 1/8"	64185-3-V-06	64185-3-VR-06	64185-3-VRR-06	N/A
10 x 29mm	64185-3-V-10	64185-3-VR-10	64185-3-VRR-10	N/A
23 x 1" x 30 degree	64185-3-W-30	64185-3-VR-30	64185-3-VRR-30	64185-3-VRRR-30
23 x 24mm x 25 degree	64185-3-V-41	64185-3-VR-41	64185-3-VRR-41	N/A
26 x 1 5/32"	64185-3-V-36	64185-3-VR-36	64185-3-VRR-36	64185-3-VRRR-36
29 x 1 1/4"	64185-3-V-58	64185-3-VR-58	64185-3-VRR-58	64185-3-VRRR-58



FULL CIRCLE NESTED | 12-rivet Offset hubs designed to engage short splines on some input shafts.

 "Nested" Hub Configuration for crank bolt clearance				
Input Shaft Size (# of teeth x diameter)	1-plate	2-plate	3-plate	4-plate
20 x 7/8"	64185-2-H-25	64185-2-HJ-25	N/A	N/A
23 x 1" x 30 degree	64185-2-H-30	64185-2-HJ-30	N/A	N/A

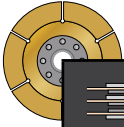

Standard disc that is suitable for most applications.

Six friction pads provide maximum surface area for low wear rate and high heat capacity

FULL CIRCLE | 6-rivet

 "Back-to-Back" Hub Configuration			
Input Shaft Size (# of teeth x diameter)	1-plate	2-plate	3-plate
10 x 7/8"	64140-9-A-03	64140-9-AA-03	N/A
10 x 1"	64140-9-A-04	64140-9-AA-04	N/A
10 x 1 1/4"	64140-9-A-07	64140-9-AA-07	N/A
10 x 1 1/8"	64140-9-A-06	64140-9-AA-06	64140-9-ABA-06
10 x 1 3/8"	64140-9-A-08	64140-9-AA-08	64140-9-ABA-08
10 x 29mm	64140-9-A-10	64140-9-AA-10	64140-9-ABA-10
10 x 35mm	64140-9-A-52	64140-9-AA-52	64140-9-ABA-52
14 x 25mm	64140-9-A-12	64140-9-AA-12	N/A
14 x 30.8mm	64140-9-A-14	64140-9-AA-14	64140-9-ABA-14
18 x 21mm	64140-9-A-17	64140-9-AA-17	N/A
18 x 1 3/16"	64140-9-A-19	64140-9-AA-19	64140-9-ABA-19
20 x 7/8"	64140-9-F-25	64140-9-AA-25	64140-9-ABA-25
21 x 29/32"	64140-9-A-26	64140-9-AA-26	64140-9-ABA-26
21 x 24mm	64140-9-A-27	64140-9-AA-27	N/A
21 x 29mm	64140-9-A-28	64140-9-AA-28	64140-9-ABA-28
22 x 15/16"	64140-9-A-42	64140-9-AA-42	N/A
22 x 1"	64140-9-A-29	64140-9-AA-29	64140-9-ABA-29
22 x 29.4mm	64140-9-A-51	64140-9-AA-51	64140-9-ABA-51
23 x 1" x 30 degree	64140-9-F-30	64140-9-AA-30	64140-9-ABA-30
23 x 24mm x 25 degree	64140-9-A-41	64140-9-AA-41	64140-9-ABA-41
24 x 13/16"	64140-9-A-32	64140-9-AA-32	N/A
24 x 15/16"	64140-9-A-47	64140-9-AA-47	N/A
24 x 1 x 27.5 degree (early Nissan)	64140-9-A-33	64140-9-AA-33	64140-9-ABA-33
24 x 1 x 30 degree (late Nissan)	64140-9-A-57	64140-9-AA-57	64140-9-ABA-57
24 x 26mm	64140-9-A-38	64140-9-AA-38	N/A
26 x 1 5/32"	64140-9-A-36	64140-9-AA-36	64140-9-ABA-36
26 x 35mm	64140-9-A-55	64140-9-AA-55	64140-9-ABA-55
28 x 7/8"	64140-9-A-39	64140-9-AA-39	N/A
29 x 1 1/4"	64140-9-A-58	64140-9-AA-58	64140-9-ABA-58

 "Stacked" Hub Configuration				
Input Shaft Size (# of teeth x diameter)	1-plate	2-plate	3-plate	4-plate
10 x 1 1/16"	64140-9-A-05	64140-9-AC-05	64140-9-ACC-05	N/A
10 x 35 mm	64140-9-A-52	64140-9-AC-52	64140-9-ACC-52	N/A
10 x 29mm	64140-9-A-10	64140-9-AC-10	64140-9-ACC-10	N/A
18 x 25/32"	64140-9-A-18	64140-9-AC-18	64140-9-ACC-18	N/A
20 x 7/8"	64140-9-F-25	64140-9-AC-25	64140-9-ACC-25	N/A
21 x 29/32"	64140-9-A-26	64140-9-AC-26	64140-9-ACC-26	N/A
23 x 1" x 30 degree	64140-9-F-30	64140-9-AC-30	64140-9-ACC-30	64140-9-ACCC-30
23 x 24mm x 25 degree	64140-9-A-41	64140-9-AC-41	64140-9-ACC-41	N/A
24 x 13/16"	64140-9-A-32	64140-9-AC-32	64140-9-ACC-32	N/A
24 x 1" (late Nissan)	64140-9-A-57	64140-9-AC-57	64140-9-ACC-57	N/A
26 x 22mm	64140-9-A-35	64140-9-AC-35	64140-9-ACC-35	N/A
26 x 1 5/32"	64140-9-A-36	64140-9-AC-36	64140-9-ACC-36	64140-9-ACCC-36
26 x 35mm	64140-9-A-55	64140-9-AC-55	64140-9-ACC-55	N/A



Lower inertia than full-circle discs, but have a slightly higher wear rate. Smooth radius between the friction segments also lowers core plate stress cause by misalignment between engine & transmission and/or engine harmonics, resisting core plate cracking.

PADDLE | 8-rivet

"Back-to-Back" Hub Configuration

Input Shaft Size (# of teeth x diameter)	1-plate	2-plate	3-plate
10 x 7/8"	64140-3-A-03	64140-3-AA-03	N/A
10 x 1"	64140-3-A-04	64140-3-AA-04	N/A
10 x 1 1/4"	64140-3-A-07	64140-3-AA-07	N/A
10 x 1 1/8"	64140-3-A-06	64140-3-AA-06	64140-3-ABA-06
10 x 1 3/8"	64140-3-A-08	64140-3-AA-08	64140-3-ABA-08
10 x 29mm	64140-3-A-10	64140-3-AA-10	64140-3-ABA-10
10 x 35mm	64140-3-A-52	64140-3-AA-52	64140-3-ABA-52
14 x 25mm	64140-3-A-12	64140-3-AA-12	N/A
14 x 30.8mm	64140-3-A-14	64140-3-AA-14	64140-3-ABA-14
18 x 21mm	64140-3-A-17	64140-3-AA-17	N/A
18 x 1 3/16"	64140-3-A-19	64140-3-AA-19	64140-3-ABA-19
20 x 7/8"	64140-3-F-25	64140-3-AA-25	64140-3-ABA-25
21 x 29/32"	64140-3-A-26	64140-3-AA-26	64140-3-ABA-26
21 x 24mm	64140-3-A-27	64140-3-AA-27	N/A
21 x 29mm	64140-3-A-28	64140-3-AA-28	64140-3-ABA-28
22 x 15/16"	64140-3-A-42	64140-3-AA-42	N/A
22 x 1"	64140-3-A-29	64140-3-AA-29	64140-3-ABA-29
22 x 29.4mm	64140-3-A-51	64140-3-AA-51	64140-3-ABA-51
23 x 1" x 30 degree	64140-3-F-30	64140-3-AA-30	64140-3-ABA-30
23 x 24mm x 25 degree	64140-3-A-41	64140-3-AA-41	64140-3-ABA-41
24 x 13/16"	64140-3-A-32	64140-3-AA-32	N/A
24 x 15/16"	64140-3-A-47	64140-3-AA-47	N/A
24 x 1" (early Nissan)	64140-3-A-33	64140-3-AA-33	64140-3-ABA-33
24 x 1" (late Nissan)	64140-3-A-57	64140-3-AA-57	64140-3-ABA-57
24 x 26mm	64140-3-A-38	64140-3-AA-38	N/A
26 x 1 5/32"	64140-3-A-36	64140-3-AA-36	64140-3-ABA-36
26 x 35mm	64140-3-A-55	64140-3-AA-55	64140-3-ABA-55
28 x 7/8"	64140-3-A-39	64140-3-AA-39	N/A
29 x 1 1/4"	64140-3-A-58	64140-3-AA-58	64140-3-ABA-58

"Stacked" Hub Configuration

Input Shaft Size (# of teeth x diameter)	1-plate	2-plate	3-plate	4-plate
10 x 1 1/16"	64140-3-A-05	64140-3-AC-05	64140-3-ACC-05	N/A
10 x 35 mm	64140-3-A-52	64140-3-AC-52	64140-3-ACC-52	N/A
10 x 29mm	64140-3-A-10	64140-3-AC-10	64140-3-ACC-10	N/A
18 x 25/32"	64140-3-A-18	64140-3-AC-18	64140-3-ACC-18	N/A
20 x 7/8"	64140-3-F-25	64140-3-AC-25	64140-3-ACC-25	N/A
21 x 29/32"	64140-3-A-26	64140-3-AC-26	64140-3-ACC-26	N/A
23 x 1" x 30 degree	64140-3-F-30	64140-3-AC-30	64140-3-ACC-30	64140-3-ACCC-30
23 x 24mm x 25 degree	64140-3-A-41	64140-3-AC-41	64140-3-ACC-41	N/A
24 x 13/16"	64140-3-A-32	64140-3-AC-32	64140-3-ACC-32	N/A
24 x 1" (late Nissan)	64140-3-A-57	64140-3-AC-57	64140-3-ACC-57	N/A
26 x 22mm	64140-3-A-35	64140-3-AC-35	64140-3-ACC-35	N/A
26 x 1 5/32"	64140-3-A-36	64140-3-AC-36	64140-3-ACC-36	64140-3-ACCC-36
26 x 35mm	64140-3-A-55	64140-3-AC-55	64140-3-ACC-55	N/A

Tilton OT-Series Clutch-Flywheel-Assemblies are designed to be a direct replacement for OEM clutch/flywheels assemblies, retaining the same diameter (ring gear size) as originally equipped with the car.

Assemblies include a Tilton OT-Series clutch, billet steel flywheel and hardware. Some assemblies also include a Tilton hydraulic release bearing that is designed to replace the OEM release bearing system.

Clutch-Flywheel-Assemblies are available with either an OT-Series metallic clutch, cerametallic clutch or carbon/carbon clutch.

OT-Series Metallic Clutch-Flywheel-Assembly



P/N 57-813

OT-Series Cerametallic Clutch-Flywheel-Assembly



P/N 56-821

OT-Series Carbon/Carbon Clutch-Flywheel-Assembly



P/N 57-814



Features

- ▶ OT-series metallic clutch (5.5" or 7.25")
- ▶ Clutch disc pack
- ▶ Billet steel flywheel
- ▶ Hydraulic release bearing (most applications)
- ▶ Aircraft-grade clutch bolt kit

Application	Clutch	Torque Capacity (lb-ft)	Weight (lbs)	Part Number
BMW E36/E46	7.25" 3-disc	840	17.8	56-823
BMW E46 M3	7.25" 3-disc	840	17.8	56-824
Chevy Camaro Gen 5	7.25" 3-disc	1020	18.0	56-816
Chevy Corvette C5	7.25" 3-disc	1020	18.0	56-804
Chevy Corvette C6	7.25" 3-disc	1020	18.0	56-807
Chevy Corvette C7	7.25" 3-disc	1020	21.6	56-809
Mitsubishi EVO 7-9	7.25" 3-disc	1005	20.8	56-358
Mitsubishi EVO 10	7.25" 3-disc	1005	22.1	56-357
Porsche 993/996/997	5.5" 3-disc	750	14.5	57-813
Porsche 993/996/997	7.25" 2-disc	560	15.4	56-813
Porsche 993/996/997 (light FW)	7.25" 3-disc	1020	17.8	56-815
Porsche 993/996/997 (heavy FW)	7.25" 3-disc	1020	28.4	56-815H

Service Parts

CFA	Clutch	Disc Pack	Flywheel	Release Bearing	Clutch Bolt Kits
56-823	66-003HORA	64185-2-ABA-10	51-3568	62-021	95-011
56-824	66-003HORA	64185-2-ABA-52	51-3568	62-022	95-011
56-357	66-003HORA	64185-2-ACC-30	51-4335	61-9012	95-011
56-358	66-003HORA	64185-2-ACC-30	51-4334	61-9012	95-011
56-804	66-003HG	64185-2-ACC-36	51-4452	60-8270	95-006
56-807	66-003HG	64185-2-ACC-36	51-4552	60-8270	95-006
56-809	66-003HG	64185-2-ACC-36	51-4558	60-8290	95-011
56-813	66-012HORA	64185-3-VR-30	51-4008	60-8270	95-070
56-815	66-013HG	64185-3-VRR-30	51-4008	60-8250	95-074
56-815H	66-013HG	64185-3-VRR-30	51-4012	60-8250	95-074
56-816	66-003HG	64185-2-ACC-36	51-4452	60-8260	95-006
57-813	67-013HG	64140-3-ACC-30	51-4011	60-8340	95-071



Features

- ▶ OT-II 7.25" cerametallic clutch
- ▶ Clutch disc pack
- ▶ Billet steel flywheel
- ▶ Hydraulic release bearing (most applications)
- ▶ Aircraft-grade clutch bolt kit

Application	Clutch	Torque Capacity (lb-ft)	Weight (lbs)	Part Number
BMW E36/E46	7.25" 1-disc	335	13.5	56-820
BMW E46 M3	7.25" 2-disc	570	16.1	56-821
BMW E46 M3	7.25" 2-disc	570	16.1	56-822
Honda B16A/B18	7.25" 2-disc	910	18.6	56-300H
Honda B16A/B18	7.25" 2-disc	910	18.6	56-300H-KIT*
Honda K20/K24	7.25" 2-disc	910	14.9	56-309
Honda K20/K24	7.25" 2-disc	910	14.9	56-309H-KIT*
Mitsubishi EVO 7-9	7.25" 2-disc	910	19.1	56-353
Mitsubishi EVO 10	7.25" 2-disc	910	20.4	56-356
Porsche 993/996/997	7.25" 2-disc	680	16.1	56-812
Subaru WRX/STI (2002-on)	7.25" 2-disc	840	19.8	56-371

*Includes hydraulic release bearing/master kit (P/N 61-7770)

Service Parts

CFA	Clutch	Disc Pack	Flywheel	Release Bearing	Clutch Bolt Kits
56-300H	66-302UGG	64185-8-VV-38	51-1166	62-010	95-011
56-300H-KIT	66-302UGG	64185-8-VV-38	51-1166	61-777	95-011
56-309	66-302UGG	64185-8-VV-38	51-1180	62-010	95-011
56-309-KIT	66-302UGG	64185-8-VV-38	51-1180	61-777	95-011
56-353	66-302UGG	64185-8-VW-30H	51-4334	61-9012	95-011
56-356	66-302UGG	64185-8-VW-30H	51-4335	61-9012	95-011
56-371	66-302UG	64185-8-VV-47	51-4122	61-742	95-011
56-812	66-312HG	64185-8-VV-30	51-4008	60-8250	95-074
56-820	66-301UORA	64185-8-W-10	51-3568	62-020	95-010
56-821	66-302UBF	64185-8-VV-10	51-3568	62-021	95-011
56-822	66-302UBF	64185-8-VV-52	51-3568	62-022	95-011



Features

- ▶ OT-series carbon/carbon clutch (5.5" or 7.25")
- ▶ Billet steel flywheel
- ▶ Hydraulic release bearing (most applications)
- ▶ Aircraft-grade clutch bolt kit

Application	Clutch	Torque Capacity (lb-ft)	Weight (lbs)	Part Number
Chevy Camaro Gen 5	7.25" 3-disc	1230	15.6	56-816C
Chevy Corvette C5	7.25" 3-disc	1230	15.6	56-805
Chevy Corvette C6	7.25" 3-disc	1230	15.6	56-808
Chevy Corvette C7	7.25" 3-disc	1230	19.2	56-810
Honda B16A/B18	7.25" 2-disc	910	16.0	56-302H
Honda K20/K24	7.25" 2-disc	910	12.5	56-311
Mitsubishi EVO 7-9	7.25" 2-disc	910	17.1	56-352
Mitsubishi EVO 10	7.25" 2-disc	910	18.4	56-355
Porsche 993/996/997	5.5" 3-disc	750	11.6	57-814
Porsche 993/996/997 (light FW)	7.25" 3-disc	1365	14.3	56-814
Porsche 993/996/997 (heavy FW)	7.25" 3-disc	1365	24.9	56-814H
Subaru WRX/STI (2002-on)	7.25" 2-disc	840	17.8	56-372

Service Parts

CFA	Clutch	Flywheel	Release Bearing	Clutch Bolt Kits
56-302H	6572USGG-S-SDR	51-1166	62-010	95-063
56-311	6572USGG-S-SDR	51-1180	62-010	95-063
56-352	6572USGG-S-SDR	51-4334	61-9002	95-063
56-355	6572USGG-S-SDR	51-4335	61-9002	95-063
56-372	6572USGG-S	51-4122	61-732	95-063
56-805	6573USGG-S	51-4452	60-8220	95-016
56-808	6573USGG-S	51-4452	60-8220	95-016
56-810	6573USGG-S	51-4558	60-8250	95-016
56-814	6573USGG-P	51-4008	60-8200	95-073
56-814H	6573USGG-P	51-4012	60-8200	95-073
56-816C	6573USGG-S	51-4452	60-8210	95-016
57-814	6553HSG-P	51-4011	60-8330	95-072



Typical Applications

- Late Model
- Super Late Model
- Asphalt Modified

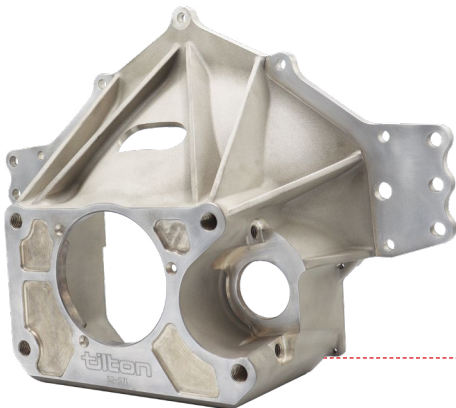
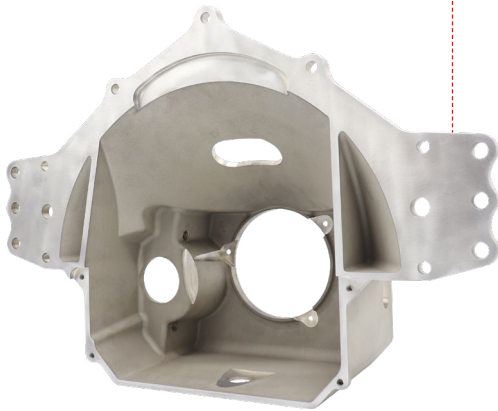

Features

➤ Bellhousing

- Magnesium rear-mount starter bellhousing designed for maximum weight savings
- Compact design provides increase ground clearance and exhaust header clearance. Distance from centerline of crankshaft to bottom of bellhousing is only 4.5"
- Integral mounting ears for use as rear engine mount
- Accepts transmissions with Chevy 4-bolt mounting pattern and 4.68" register diameter
- Blueprinted for parallelism and concentricity
- Weighs 7.6 lbs

➤ Clutch-Flywheel-Assembly

- 5.5 ULTRA metallic clutch. 2-disc and 3-disc options
- Billet steel 99-tooth (8.42") ring gear
- Button Flywheel
- 26-Spline clutch disc pack
- Aircraft-grade clutch bolts
- High-strength ARP flywheel bolts

➤ Hydraulic Release Bearing

- 2300-Series hydraulic release bearing
- 38mm contact diameter bearing
- 3-bolt bellhousing mounted

➤ Starter

- 40000-Series 3.0HP high-torque gear reduction mini starter
- Rear-mounts on bellhousing
- Side-bolt mounting design provides secure mounting to bellhousing and easy access for service

Clutch Type*	Chevy Early	Chevy Crate	Chevy LS	Ford Small Block
5.5 ULTRA 2-disc	52-61620	52-64620	52-63620	52-62620
5.5 ULTRA 3-disc	52-61630	52-64630	52-63630	52-62630

*Fits 1 5/32" x 26 spline input shaft. Contact Tilton for other spline options.

Service Parts

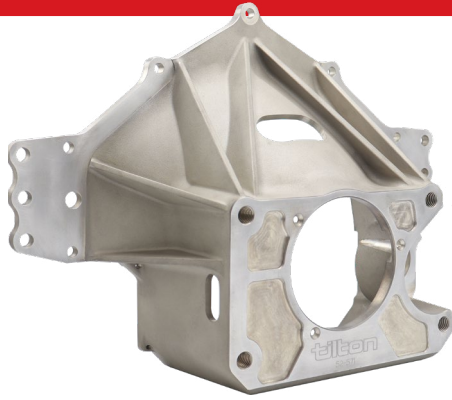

Bellhousings

Description	Part Number
Bellhousing, Chevy, magnesium	52-571
Bellhousing, Ford, magnesium	52-572



Flywheel

Description	Part Number
Button flywheel, Chevy Early	19038
Button flywheel, Chevy Crate, balanced	19042
Button flywheel, Chevy LS	19041
Button flywheel, Ford Small Block	19043
Ring gear, 99-tooth	51-099-2
Ring gear spacer, ULTRA 5.5 2-disc	



Clutch & Disc Packs

Description	Part Number
5.5 ULTRA, 2-disc metallic	67-202HG
Disc pack, 2 discs, 26 spline	64140-1-AA-36
5.5 ULTRA, 3-disc metallic	67-203HG
Disc pack, 3 disc, 26-spline	64140-1-ABA-36



Hydraulic Release Bearing

Description	Part Number
HRB, 5.5 ULTRA 2-disc clutch	60-2340
HRB, 5.5 ULTRA 3-disc clutch	60-2310



Starter

Description	Part Number
Super Starter, bellhousing mount	54-41072



Bolt Kits

Description	Part Number
Clutch bolt kit	95-036
Flywheel bolt kit, all except Chevy LS	95-952-6
Flywheel bolt kit, Chevy LS	95-940-6



Typical Applications

- Trans Am (TA, TA2)
- GT1
- Late Model
- Super Late Model
- Asphalt Modified



Features

- **Bellhousing**
 - Rigid aluminum rear-mount starter bellhousing designed to resist flexing
 - Compact design provides increase ground clearance and exhaust header clearance. Distance from centerline of crankshaft to bottom of bellhousing is only 4.7"
 - Accepts transmissions with Chevy 4-bolt mounting pattern and 4.68" register diameter
 - Blueprinted for parallelism and concentricity
 - Weighs 12.5 lbs
- **Clutch-Flywheel-Assembly**
 - OT-III 5.5" metallic or carbon/carbon clutch. 3-disc and 4-disc options
 - Billet steel 102-tooth (8.64") flywheel
 - 26-spline clutch disc pack
 - Aircraft-grade clutch bolts
 - High-strength ARP flywheel bolts
- **Hydraulic Release Bearing**
 - 5300-Series hydraulic release bearing
 - 38mm contact diameter bearing
 - 4-bolt bellhousing mounted
- **Starter**
 - 40000-Series 3.0HP high-torque gear reduction mini starter
 - Rear-mounts on bellhousing

Clutch Type*	Chevy Early	Chevy Crate	Chevy LS	Ford Small Block
5.5" 2-disc metallic	52-31120	52-41120	52-33120	52-32120
5.5" 3-disc metallic	52-31130	52-41130	52-33130	52-32130
5.5" 4-disc metallic	52-31140	NA	52-33140	52-32140
5.5" 3-disc carbon	52-31230	NA	52-33230	52-32230
5.5" 4-disc carbon	52-31240	NA	52-33240	52-32240

*Fits 1 5/32" x 26 spline input shaft. Contact Tilton for other spline options.

Service Parts



Bellhousings

Description	Part Number
Bellhousing, Chevy, aluminum	52-601
Bellhousing, Ford, aluminum	52-602



Flywheel

Description	Part Number
Flywheel, Chevy Early, 102-tooth	51-651
Flywheel, Chevy Crate, 102-tooth, balanced	51-604
Flywheel, Chevy LS, 102-tooth	51-659
Flywheel, Ford, 102-tooth	51-653



Clutch & Disc Packs

Description	Part Number
Clutch, 5.5" 2-disc metallic	67-002HG
Disc pack, 2 discs, 26-spline	64140-9-AA-36
Clutch, 5.5" 3-disc metallic	67-003HG
Disc pack, 3-disc, 26-spline	64140-9-ABA-36
Clutch, 5.5" 4-Disc metallic	67-004HG
Disc pack 4-discs, 26-spline	64140-9-ACCC-36
Clutch, 5.5" 3-disc carbon	6553HSG-S
Clutch, 5.5" 4-disc carbon	6554HSG-S

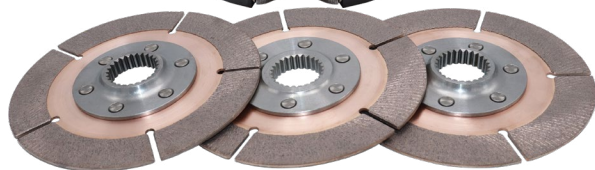

Hydraulic Release Bearing

Description	Part Number
HRB, 5.5" 2-disc metallic clutch	60-5370
HRB, 5.5" 3-disc metallic clutch	60-5340
HRB, 5.5" 4-disc metallic clutch	60-5310
HRB, 5.5" 3-disc carbon clutch	60-5330
HRB, 5.5" 4-disc carbon clutch	60-5300



Starter

Description	Part Number
Super Starter, bellhousing mount	54-41062



Bolt Kits

Description	Part Number
Clutch bolt kit, 5.5" 2-disc metallic	95-002-5
Clutch bolt kit, 5.5" 3-disc metallic	95-003-5
Clutch bolt kit, 5.5" 4-disc metallic	95-004-5
Clutch bolt kit, 5.5" 3-disc carbon	95-061
Clutch bolt kit, 5.5" 4-disc carbon	95-060
Flywheel bolt kit, Chevy Early & Ford	95-952-6
Flywheel bolt kit, Chevy LS	95-940-6
Flywheel bolt kit, Chevy Crate	95-975-6



OE Diameter Flywheels

OE Diameter flywheels are designed to be a direct replacement for the stock flywheels of specific car/engine applications, retaining the same diameter (ring gear size) as originally equipped with the car.

Unless noted, flywheels are neutral balance and have a .100" step for the clutch's friction surface.

Application	Clutch Type	Ring Gear Teeth	Weight (lbs)	Part Number
BMW M50/M52/S50/S52/S54	7.25" 6/12-leg	113	7.9	51-3568
Chevy V8 2-pc Rear Main Seal	7.25" 6/12-leg	153	8.3	51-021-1
Chevy V8 2-pc Rear Main Seal	Tilton ST-246	153	16.6	55-1002
Chevy LS (6-Bolt Crank)	7.25" 6/12-leg	168	8.0	51-4452
Chevy LS (6-Bolt Crank)	Tilton ST-246	168	19.6	51-1004
Chevy LSX/LT (8-Bolt Crank)	7.25" 6/12-leg	168	11.7	51-4558
Chevy LSX/LT (8-Bolt Crank)	Tilton ST-246	168	19.6	51-1008
Chevy Camaro GEN6/Corvette C7	Tilton ST-246	168	21.5	51-1000
Ford Coyote	Tilton ST-246	164	20.9	51-1001
Ford Small Block (Internal Balance)	Tilton ST-246	157	17.2	51-1003
Honda B16A/B18	7.25" 6/12-leg	112	9.8	51-1166
Honda K20/24	7.25" 6/12-leg	120	6.3	51-1180
Mitsubishi EVO-7-9	7.25" 6/12-leg	114	10.9	51-4334
Mitsubishi EVO 10	7.25" 6/12-leg	114	9.4	51-4335
Porsche 993/996/997	7.25" 6/12-leg	132	7.9	51-4008*
Porsche 993/996/997	7.25" 6/12-leg	132	18.5	51-4012*
Porsche 993/996/997	5.5" 8-leg	132	7.2	51-4011*
Subaru WRX (EJ20/25)	7.25" 6/12-leg	124	11.6	51-4122
Toyota 2JZ	7.25" 6/12-leg	115	12	51-5021

*Pot-type flywheel



Reduced Diameter Flywheels

Smaller diameter than OEM type flywheels to provide addition ground clearance and a lower weight & inertia. Requires the use of specialize Tilton Super Starter that mounts in the stock location but is designed to work with the smaller diameter ring gear. *Unless noted, flywheels are neutral balance and have a .100" step for the clutch's friction surface.*

Application	Clutch Type	Ring Gear Teeth	Weight (lbs)	Part Number
Chevy V8 2-pc Rear Main Seal	7.25" 6/12-leg	104	5.7	51-052-1*
Chevy LS (6-bolt crank)	7.25" 6/12-leg	153	9.4	51-4478**
Chevy LSX/LT (8-bolt crank)	7.25" 6/12-leg	153	9.4	51-4479**

*Requires starter P/N 54-40005

**Requires starter P/N 54-40012

110-Tooth 7.25" Flywheels

Designed for use in Tilton 52-7xx Series rear-mount starter bellhousings and 7.25" clutches.

Unless noted, flywheels are neutral balance and have a .100" step for the clutch's friction surface.

Application	Clutch Type	Ring Gear Teeth	Weight (lbs)	Part Number
Chevy V8 2-pc Rear Main Seal	7.25" 6-leg	110	4.7	51-6300
Chevy LS (6-Bolt Crank)	7.25" 6/12-leg	110	5.7	51-6341
Ford Small Block (Internal Balance)	7.25" 6/12-leg	110	4.9	51-6320





102-Tooth 5.5" Flywheels

Designed for use in Tilton 52-6xx Series rear-mount starter bell housings and 5.5" clutches. Unless noted, flywheels are neutral balance and have a .100" step for the clutch's friction surface.

Application	Clutch Type	Ring Gear Teeth	Weight (lbs)	Part Number
Chevy V8 2-pc Rear Main Seal	5.5" 8-leg	102	3.1	51-651
Chevy V8 1-pc Rear Main Seal	5.5" 8-leg	102	4.2	51-604*
Chevy LS (6-Bolt)	5.5" 8-leg	102	4.3	51-659
Ford Small Block (Internal Balance)	5.5" 8-leg	102	3.6	51-653

*Externally balanced

Button Flywheels

Designed to serve as the clutch's friction surface when used in conjunction with flexplate or clutch cover-mounted ring gear. Unless noted, flywheels are neutral balance and have .100" step for the clutch's friction surface.



Application	Clutch Type	Flywheel Offset	Weight (lbs)	Part Number
Chevy V8 2-pc Rear Main Seal	5.5" 8-leg	.840"	2.3	19002
Chevy V8 2-pc Rear Main Seal	5.5" 6-leg	.840"	2.1	19038
Chevy V8 2-pc Rear Main Seal	7.25" 6-leg	.660"	3.7	19003
Chevy V8 1-pc Rear Main Seal	5.5" 8-leg	.820"	2.5	19010
Chevy V8 1-pc Rear Main Seal	5.5" 8-leg	.840"	2.9	19023*
Chevy V8 1-pc Rear Main Seal	5.5" 6-leg	.840"	3.0	19042*
Chevy V8 1-pc Rear Main Seal	7.25" 6-leg	.700"	3.8	19011
Chevy V8 1-pc Rear Main Seal	7.25" 6-leg	.660"	4.0	19046*
Chevy LS (6-Bolt Crank)	5.5" 8-leg	1.240"	2.9	19044
Chevy LS (6-Bolt Crank)	5.5" 6-leg	1.240"	2.7	19041
Chevy LS (6-Bolt Crank)	7.25" 6-leg	1.060"	4.3	19040
Ford Small Block	5.5" 8-leg	1.280"	3.0	19045
Ford Small Block	5.5" 6-leg	1.280"	2.8	19043
Ford Small Block	7.25" 6-leg	1.110"	4.2	19039

*Externally balanced

Clutch Cover-Mount Ring Gears

Designed to mount onto the clutch cover of select Tilton and QM clutches.



Clutch Type	Ring Gear Teeth	Weight (lbs)	Part Number
5.5" 6/8-leg	110	1.7	51-110-1
5.5" 6-leg	99	1.3	51-099-2
7.25" 6-leg	110	1.1	51-110-3

Metallic Clutch Bolt Kits

	Clutch Diameter	Plate Count	Flywheel	Mounting Hole	Size	Length	Length	Part Number
	(inches)	(number)	(type)	(type)	(inches)	(under head)	(grip)	
5.5" Clutches	5.5"	1	Step	Through	5/16"-24	1.72"	1.19"	95-001-5
	5.5"	1	Step	Threaded	5/16"-24	1.47"	.938"	95-015
	5.5"	2	Step/Pot	Through	5/16"-24	1.97"	1.44"	95-002-5
	5.5"	2	Step	Threaded	5/16"-24	1.84"	1.31"	95-009-5
	5.5"	2	Pot	Threaded	5/16"-24	1.72"	1.19"	95-010-5
	5.5"	3	Step	Through	5/16"-24	2.34"	1.81"	95-019
	5.5"	3	Pot	Through	5/16"-24	2.22"	1.69"	95-003-5
	5.5"	3	Step	Threaded	5/16"-24	2.09"	1.56"	95-018
	5.5"	3	Pot	Threaded	5/16"-24	1.97"	1.44"	95-002-5
	5.5"	4	Step	Through	5/16"-24	2.59"	2.06"	95-004-5
	5.5"	4	Pot	Through	5/16"-24	2.47"	1.94"	95-061
	5.5"	4	Step	Threaded	5/16"-24	2.34"	1.81"	95-019
	5.5"	4	Pot	Threaded	5/16"-24	2.22"	1.69"	95-003-5

7.25" Clutches	7.25"	1	Step	Through	5/16"-24	1.47"	.938"	95-026
	7.25"	1	Step	Threaded	5/16"-24	1.34"	.813"	95-009
	7.25"	2	Step	Through	5/16"-24	1.84"	1.31"	95-017
	7.25"	2	Pot	Through	5/16"-24	1.72"	1.19"	95-005
	7.25"	2	Step	Threaded	5/16"-24	1.59"	1.06"	95-028
	7.25"	2	Pot	Threaded	5/16"-24	1.47"	.938"	95-010
	7.25"	3	Step	Through	5/16"-24	2.09"	1.56"	95-018
	7.25"	3	Pot	Through	5/16"-24	1.97"	1.44"	95-006
	7.25"	3	Step	Threaded	5/16"-24	1.84"	1.31"	95-011
	7.25"	3	Pot	Threaded	5/16"-24	1.72"	1.19"	95-014
	7.25"	4	Step	Through	5/16"-24	2.34"	1.81"	95-008
	7.25"	4	Pot	Through	5/16"-24	2.22"	1.69"	95-003-5
	7.25"	4	Step/Pot	Threaded	5/16"-24	2.09"	1.56"	95-012

Cerametallic Clutch Bolt Kits

	Clutch Diameter	Plate Count	Flywheel	Mounting Hole	Size	Length	Length	Part Numbers
	(inches)	(number)	(type)	(type)	(inches)	(under head)	(grip)	
7.25" Clutches	7.25"	1	Step	Through	5/16"-24	1.59"	1.06"	95-028
	7.25"	1	Step	Threaded	5/16"-24	1.47"	.938"	95-010
	7.25"	2	Step	Through	5/16"-24	2.09"	1.56"	95-018
	7.25"	2	Step	Threaded	5/16"-24	1.84"	1.31"	95-011

Note for all bolt kits:

Step-type Flywheel: Clutch friction surface is .100" above clutch mounting surface.

Pot-type Flywheel: Clutch friction surface is equal to clutch mounting surface.



Carbon/Carbon Clutch Bolt Kits

	Clutch Diameter	Plate Count	Flywheel	Mounting Hole	Size	Length	Length	Part Numbers
	(inches)	(number)	(type)	(type)	(inches)	(under head)	(grip)	
5.5" Clutches	5.5"	1	Step/Pot	Through	5/16"-24	1.72"	1.19"	95-001-5
	5.5"	1	Step	Threaded	5/16"-24	1.59"	1.06"	95-029
	5.5"	1	Pot	Threaded	5/16"-24	1.47"	.938"	95-015
	5.5"	2	Step	Through	5/16"-24	2.09"	1.56"	95-018
	5.5"	2	Pot	Through	5/16"-24	1.97"	1.44"	95-002-5
	5.5"	2	Step	Threaded	5/16"-24	1.84"	1.31"	95-009-5
	5.5"	2	Pot	Threaded	5/16"-24	1.72"	1.19"	95-010-5
	5.5"	3	Step	Through	5/16"-24	2.47"	1.94"	95-061
	5.5"	3	Pot	Through	5/16"-24	2.34"	1.81"	95-019
	5.5"	3	Step	Threaded	5/16"-24	2.22"	1.69"	95-003-5
	5.5"	3	Pot	Threaded	5/16"-24	2.09"	1.56"	95-018
	5.5"	4	Step	Through	5/16"-24	2.72"	2.19"	95-060
	5.5"	4	Pot	Through	5/16"-24	2.59"	2.06"	95-004-5
	5.5"	4	Step	Threaded	5/16"-24	2.47"	1.94"	95-061
	5.5"	4	Pot	Threaded	5/16"-24	2.34"	1.81"	95-019

7.25" Clutches	7.25"	1	Step/Pot	Through	5/16"-24	1.72"	1.19"	95-020
	7.25"	1	Step/Pot	Threaded	5/16"-24	1.47"	.938"	95-041
	7.25"	2	Step	Through	5/16"-24	2.09"	1.56"	95-027
	7.25"	2	Pot	Through	5/16"-24	1.97"	1.44"	95-023
	7.25"	2	Step/Pot	Threaded	5/16"-24	1.84"	1.31"	95-063
	7.25"	3	Step/Pot	Through	5/16"-24	2.47"	1.94"	95-016
	7.25"	3	Step/Pot	Threaded	5/16"-24	2.22"	1.69"	95-025
	7.25"	4	Pot	Through	5/16"-24	2.84"	2.31"	95-065
	7.25"	4	Step	Threaded	5/16"-24	2.72"	2.19"	95-064
	7.25"	4	Pot	Threaded	5/16"-24	2.59"	2.06"	95-042

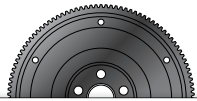

Flywheel Bolt Kits

Bolt kit for mounting Tilton flywheels to the engine crank shaft.

Size	Length	Socket Size	Bolts in Kit	Part Numbers
(inches)	(under head)	(inches)	(number)	
7/16"-20	.875"	1/2" 12-pt	6	95-952-6
7/16"-20	.875"	1/2" 12-pt	8	95-952-8
7/16"-20	.800"	3/4" 12-pt	6	95-975-6
7/16"-20	.800"	3/4" 12-pt	8	95-975-8
11mm x 1.5	.880"	1/2" 12-pt	6	95-940-6

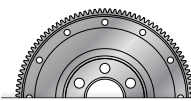

Clutch-to-Flywheel Stud Kits

Clutch-to-Flywheel Stud Kits are designed to press fit into specific Tilton flywheels, such as the 110-tooth flywheel supplied in 52-Series 7.25" Rear-mount Starter Packages.

Clutch Diameter	Plate Count	Part Numbers
(inches)	(number)	
7.25"	3	95-100-6
7.25"	2	95-101-6

Tilton offers an extensive range of hydraulic release bearings, also known as concentric slave cylinders, for use with push-type clutches. Hydraulic release bearings are designed to eliminate the need for mechanical linkages, pivot balls, spacer and external slave cylinders. Tilton hydraulic release bearings are available with a flat-face bearing for use with bent-finger diaphragm 8.5" – 11" OE-type clutches and with radius-face bearings for small diameter racing clutches (4.5", 5.5", 7.25" & 8.5").

Features

- ▶ High-temperature mono-seal features a quad tensioner to insure proper seal tension for the highest level of reliability. Seals have been tested to more than a million actuations without failure
- ▶ Wiper seal (most models) provides protection from debris entering bore.
- ▶ Aluminum body and piston are plated with a proprietary low-friction coating that provides smooth operation and longevity.
- ▶ High quality bearings packed with high-speed grease provide long term service life.
- ▶ Constant contact design provides for quick clutch release and self-adjusts for clutch wear.
- ▶ 1.215 in² piston area (except 9000-Series)

700-Series

Pilot tube mount



1000-Series

Saab 9000 type mount



2000-Series

3-Leg QM-type bellhousing mount



3000-Series

3-leg bulkhead mount



4000-Series

4-bolt bellhousing mount



5000-Series

4-bolt bellhousing mount (low profile)



6000-Series

Adjustable height transmission mount



8000-Series

2-bolt bulkhead mount



9000-Series

2-bolt bulkhead mount (reduced piston area)



Typical Applications

- Transmissions and transaxles designed to accept "Saab 9000-type" release bearings

Features

- **Mount Type:** 3-Bolt "Saab 9000-Type" pattern
- **Piston Area:** 1.215in² (784mm²)
- **Max Stroke:** .600" (15.24mm)
- **Ports:** AN3 (3/8"-24 thread)
- **Weight:** .70 - .95 lbs (varies by model)



1000-Series		Bearing Type: Radius-face Contact Diameter: 2.05" (52mm)		
Part Number	Height	Replacement Bearing	Replacement Piston	Seal Kit
60-1000	2.04" (51.8mm)	62-002	62-612	62-905



1100-Series		Bearing Type: Flat-face Contact Diameter: 1.71" - 2.83" (43.4mm - 71.9mm)		
Part Number	Height	Replacement Bearing	Replacement Piston	Seal Kit
60-1100	1.79" (45.5mm)	62-618	62-6100	62-905



1200-Series		Bearing Type: Radius-face Contact Diameter: 1.75" (44mm)		
Part Number	Height*	Replacement Bearing	Replacement Piston	Seal Kit
60-1200	1.87" (47.5mm)	62-031	62-6000	62-905
60-1210	1.97" (50.0mm)	62-031	62-6001	62-905
60-1220	2.07" (52.3mm)	62-031	62-6002	62-905
60-1230	2.17" (55.1mm)	62-031	62-6003	62-905
60-1240	2.27" (57.7mm)	62-031	62-6004	62-905
60-1250	2.37" (60.2mm)	62-031	62-6005	62-905
60-1260	2.47" (62.7mm)	62-031	62-6006	62-905
60-1270	2.57" (65.3mm)	62-031	62-6007	62-905
60-1280	2.67" (67.8mm)	62-031	62-6008	62-905
60-1290	2.77" (70.4mm)	62-031	62-6009	62-905

*Height can be reduced by .050" (1.27mm) by removing the shim that is located under bearing within the piston



1300-Series		Bearing Type: Radius-face Contact Diameter: 1.50" (38mm)		
Part Number	Height*	Replacement Bearing	Replacement Piston	Seal Kit
60-1300	1.87" (47.5mm)	62-008	62-6000	62-905
60-1310	1.97" (50.0mm)	62-008	62-6001	62-905
60-1320	2.07" (52.3mm)	62-008	62-6002	62-905
60-1330	2.17" (55.1mm)	62-008	62-6003	62-905
60-1340	2.27" (57.7mm)	62-008	62-6004	62-905
60-1350	2.37" (60.2mm)	62-008	62-6005	62-905
60-1360	2.47" (62.7mm)	62-008	62-6006	62-905
60-1370	2.57" (65.3mm)	62-008	62-6007	62-905
60-1380	2.67" (67.8mm)	62-008	62-6008	62-905
60-1390	2.77" (70.4mm)	62-008	62-6009	62-905

*Height can be reduced by .050" (1.27mm) by removing the shim that is located under bearing within the piston

Installation drawing for 1000-Series HRBs is available at www.tiltonracing.com/technical/installation-drawings



Typical Applications

- Mounts inside select Tilton and QM rear-mount starter bellhousings



Features

- **Mount Type:** 3-Bolt "QM-type" pattern
- **Piston Area:** 1.215in² (784mm²)
- **Max Stroke:** .600" (15.24mm)
- **Ports:** AN3 (3/8"-24 thread)
- **Weight:** .75- .85 lbs (varies by model)

Bearing Type: Radius-face
Contact Diameter: 1.75" (44mm)

2200-Series		Replacement Bearing	Replacement Piston	Seal Kit
Part Number	Height*			
60-2200	2.90" (73.7mm)	62-031	62-6000	62-905
60-2210	3.00" (76.2mm)	62-031	62-6001	62-905
60-2220	3.10" (78.7mm)	62-031	62-6002	62-905
60-2230	3.20" (81.3mm)	62-031	62-6003	62-905
60-2240	3.30" (83.8mm)	62-031	62-6004	62-905
60-2250	3.40" (86.4mm)	62-031	62-6005	62-905
60-2260	3.50" (88.9mm)	62-031	62-6006	62-905
60-2270	3.60" (91.4mm)	62-031	62-6007	62-905
60-2280	3.70" (94.0mm)	62-031	62-6008	62-905
60-2290	3.80" (96.5mm)	62-031	62-6009	62-905

*Height can be reduced by .050" (1.27mm) by removing the shim that is located under bearing within the piston

Bearing Type: Radius-face
Contact Diameter: 1.50" (38mm)

2300-Series		Replacement Bearing	Replacement Piston	Seal Kit
Part Number	Height*			
60-2300	2.90" (73.7mm)	62-008	62-6000	62-905
60-2310	3.00" (76.2mm)	62-008	62-6001	62-905
60-2320	3.10" (78.7mm)	62-008	62-6002	62-905
60-2330	3.20" (81.3mm)	62-008	62-6003	62-905
60-2340	3.30" (83.8mm)	62-008	62-6004	62-905
60-2350	3.40" (86.4mm)	62-008	62-6005	62-905
60-2360	3.50" (88.9mm)	62-008	62-6006	62-905
60-2370	3.60" (91.4mm)	62-008	62-6007	62-905
60-2380	3.70" (94.0mm)	62-008	62-6008	62-905
60-2390	3.80" (96.5mm)	62-008	62-6009	62-905

*Height can be reduced by .050" (1.27mm) by removing the shim that is located under bearing within the piston



Typical Applications

- Bulkhead mount inside transmissions or bellhousings

Features

- **Mount Type:** 3-Bolt pattern
- **Piston Area:** 1.215in² (784mm²)
- **Max Stroke:** .600" (15.24mm)
- **Ports:** AN 3 (3/8"-24 thread)
- **Weight:** .75 - 1.0 lbs (varies by model)



3000-Series		Bearing Type: Radius-face Contact Diameter: 2.05" (52mm)		
Part Number	Height*	Replacement Bearing	Replacement Piston	Seal Kit
60-3000	3.00" (76.2mm)	62-002	62-612	62-905



3100-Series		Bearing Type: Flat-face Contact Diameter: 1.71" - 2.83" (43.4mm - 71.9mm)		
Part Number	Height*	Replacement Bearing	Replacement Piston	Seal Kit
60-3100	2.74" (69.6mm)	62-618	62-6100	62-905



3200-Series		Bearing Type: Radius-face Contact Diameter: 1.75" (44mm)		
Part Number	Height*	Replacement Bearing	Replacement Piston	Seal Kit
60-3200	2.82" (71.6mm)	62-031	62-6000	62-905
60-3210	2.92" (74.2mm)	62-031	62-6001	62-905
60-3220	3.02" (76.7mm)	62-031	62-6002	62-905
60-3230	3.12" (79.2mm)	62-031	62-6003	62-905
60-3240	3.22" (81.8mm)	62-031	62-6004	62-905
60-3250	3.32" (84.3mm)	62-031	62-6005	62-905
60-3260	3.42" (86.9mm)	62-031	62-6006	62-905
60-3270	3.52" (89.4mm)	62-031	62-6007	62-905
60-3280	3.62" (91.9mm)	62-031	62-6008	62-905
60-3290	3.72" (94.5mm)	62-031	62-6009	62-905

*Height can be reduced by .050" (1.27mm) by removing the shim that is located under bearing within the piston



3300-Series		Bearing Type: Radius-face Contact Diameter: 1.50" (38mm)		
Part Number	Height*	Replacement Bearing	Replacement Piston	Seal Kit
60-3300	2.82" (71.6mm)	62-008	62-6000	62-905
60-3310	2.92" (74.2mm)	62-008	62-6001	62-905
60-3320	3.02" (76.7mm)	62-008	62-6002	62-905
60-3330	3.12" (79.2mm)	62-008	62-6003	62-905
60-3340	3.22" (81.8mm)	62-008	62-6004	62-905
60-3350	3.32" (84.3mm)	62-008	62-6005	62-905
60-3360	3.42" (86.9mm)	62-008	62-6006	62-905
60-3370	3.52" (89.4mm)	62-008	62-6007	62-905
60-3380	3.62" (91.9mm)	62-008	62-6008	62-905
60-3390	3.72" (94.5mm)	62-008	62-6009	62-905

*Height can be reduced by .050" (1.27mm) by removing the shim that is located under bearing within the piston

Installation drawing for 3000-Series HRBs is available at www.tiltonracing.com/technical/installation-drawings



Typical Applications

- Mounts inside select Tilton and Quicktime bellhousings

Features

- **Mount Type:** 4-Bolt pattern
- **Piston Area:** 1.215in² (784mm²)
- **Max Stroke:** .600" (15.24mm)
- **Ports:** AN3 (3/8"-24 thread)
- **Weight:** 1.15 - 1.45 lbs (varies by model)



4000-Series		Bearing Type: Radius-face Contact Diameter: 2.05" (52mm)		
Part Number	Height*	Replacement Bearing	Replacement Piston	Seal Kit
60-4000	2.80" (71.0mm)	62-002	62-612	62-905



4100-Series		Bearing Type: Flat-face Contact Diameter: 1.71" - 2.83" (43.4mm - 71.9mm)		
Part Number	Height*	Replacement Bearing	Replacement Piston	Seal Kit
60-4100	2.54" (64.5mm)	62-618	62-6100	62-905



4200-Series		Bearing Type: Radius-face Contact Diameter: 1.75" (44mm)		
Part Number	Height*	Replacement Bearing	Replacement Piston	Seal Kit
60-4200	2.62" (66.5mm)	62-031	62-6000	62-905
60-4210	2.72" (69.0mm)	62-031	62-6001	62-905
60-4220	2.82" (71.6mm)	62-031	62-6002	62-905
60-4230	2.92" (74.2mm)	62-031	62-6003	62-905
60-4240	3.02" (76.7mm)	62-031	62-6004	62-905
60-4250	3.12" (79.2mm)	62-031	62-6005	62-905
60-4260	3.22" (81.8mm)	62-031	62-6006	62-905
60-4270	3.32" (84.3mm)	62-031	62-6007	62-905
60-4280	3.42" (86.9mm)	62-031	62-6008	62-905
60-4290	3.52" (89.4mm)	62-031	62-6009	62-905

*Height can be reduced by .050" (1.27mm) by removing the shim that is located under bearing within the piston



4300-Series		Bearing Type: Radius-face Contact Diameter: 1.50" (38mm)		
Part Number	Height*	Replacement Bearing	Replacement Piston	Seal Kit
60-4300	2.62" (66.5mm)	62-008	62-6000	62-905
60-4310	2.72" (69.0mm)	62-008	62-6001	62-905
60-4320	2.82" (71.6mm)	62-008	62-6002	62-905
60-4330	2.92" (74.2mm)	62-008	62-6003	62-905
60-4340	3.02" (76.7mm)	62-008	62-6004	62-905
60-4350	3.12" (79.2mm)	62-008	62-6005	62-905
60-4360	3.22" (81.8mm)	62-008	62-6006	62-905
60-4370	3.32" (84.3mm)	62-008	62-6007	62-905
60-4380	3.42" (86.9mm)	62-008	62-6008	62-905
60-4390	3.52" (89.4mm)	62-008	62-6009	62-905

*Height can be reduced by .050" (1.27mm) by removing the shim that is located under bearing within the piston

Installation drawing for 4000-Series HRBs is available at www.tiltonracing.com/technical/installation-drawings



Typical Applications

- Mounts inside select Tilton and Quicktime bellhousings

Features

- **Mount Type:** Low Profile 4-Bolt Pattern
- **Piston Area:** 1.215in² (784mm²)
- **Max Stroke:** .600" (15.24mm)
- **Ports:** AN3 (3/8"-24 thread)
- **Weight:** .90 - 1.25 lbs (varies by model)



5000-Series		Bearing Type: Radius-face Contact Diameter: 2.05" (52mm)		
Part Number	Height*	Replacement Bearing	Replacement Piston	Seal Kit
60-5000	2.10" (53.3mm)	62-002	62-612	62-905



5100-Series		Bearing Type: Flat-face Contact Diameter: 1.71" - 2.83" (43.4mm - 71.9mm)		
Part Number	Height*	Replacement Bearing	Replacement Piston	Seal Kit
60-5100	1.84" (64.7mm)	62-618	62-6100	62-905



5200-Series		Bearing Type: Radius-face Contact Diameter: 1.75" (44mm)		
Part Number	Height*	Replacement Bearing	Replacement Piston	Seal Kit
60-5200	1.92" (48.8mm)	62-031	62-6000	62-905
60-5210	2.02" (51.3mm)	62-031	62-6001	62-905
60-5220	2.12" (53.8mm)	62-031	62-6002	62-905
60-5230	2.22" (56.4mm)	62-031	62-6003	62-905
60-5240	2.32" (58.9mm)	62-031	62-6004	62-905
60-5250	2.42" (61.5mm)	62-031	62-6005	62-905
60-5260	2.52" (64.0mm)	62-031	62-6006	62-905
60-5270	2.62" (66.5mm)	62-031	62-6007	62-905
60-5280	2.72" (69.1mm)	62-031	62-6008	62-905
60-5290	2.82" (71.6mm)	62-031	62-6009	62-905

*Height can be reduced by .050" (1.27mm) by removing the shim that is located under bearing within the piston



5300-Series		Bearing Type: Radius-face Contact Diameter: 1.50" (38mm)		
Part Number	Height*	Replacement Bearing	Replacement Piston	Seal Kit
60-5300	1.92" (48.8mm)	62-008	62-6000	62-905
60-5310	2.02" (51.3mm)	62-008	62-6001	62-905
60-5320	2.12" (53.8mm)	62-008	62-6002	62-905
60-5330	2.22" (56.4mm)	62-008	62-6003	62-905
60-5340	2.32" (58.9mm)	62-008	62-6004	62-905
60-5350	2.42" (61.5mm)	62-008	62-6005	62-905
60-5360	2.52" (64.0mm)	62-008	62-6006	62-905
60-5370	2.62" (66.5mm)	62-008	62-6007	62-905
60-5380	2.72" (69.1mm)	62-008	62-6008	62-905
60-5390	2.82" (71.6mm)	62-008	62-6009	62-905

*Height can be reduced by .050" (1.27mm) by removing the shim that is located under bearing within the piston

Installation drawing for 5000-Series HRBs is available at www.tiltonracing.com/technical/installation-drawings

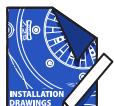

Typical Applications

- Mounts directly onto the front of transmission

Features

- **Mount Type:** Transmission
- **Piston Area:** 1.215in² (784mm²)
- **Max Stroke:** .700" (17.8mm) for 6100-Series HRBs
.600" (15.24mm) for 6000/6200 6300-Series HRBs
- **Ports:** Double o-ring swivel fittings

Description:

Height adjustable hydraulic release bearing designed to mount onto the front of transmissions. Most applications provide 1.25" of height adjustment with the provided stainless steel adjustment sleeve or mounting base that incorporates adjustment sleeve. Includes AN4 stainless braided for supply and bleed lines, bleed fitting and anti-rotation stud.



Car Specific Hydraulic Release Bearing Kits

Designed for direct fits into specific car applications. Heights preset at Tilton factory (minor adjustment may be necessary) for use with OEM clutches or Tilton ST-246 clutches. Includes adapter fitting to connect HRB to factory clutch line.

Application	Part Number
Chevy Camaro GEN5	60-6107
Chevy Camaro GEN6	60-6108
Chevy Corvette C6	60-6109
Chevy Corvette C7	60-6110



6100-Series

Bearing Type: Flat-face
Contact Diameter: 1.71"-2.83" (43.4mm-71.9mm)

Application	Transmission	Height Adjustment (inches)	Part Number
Chevy SB/BB	Tremec TKO/500/600	2.50 - 2.75**	60-6106
Chevy LS/LT	Tremec TKO/500/600	1.77 - 3.00*	60-6101
Chevy	Tremec T56 Magnum	2.16 - 3.13**	60-6105
Chevy	Tremec TR6060	2.66 - 3.63**	60-6111
Chevy	Borg-Warner/Tremec T5	1.77 - 3.00*	60-6103
Ford	Tremec TKO/500/600	1.77 - 3.00*	60-6102
Ford	Tremec T56 Magnum (Pilot tube mount)	1.77 - 3.00*	60-6104
Ford	Tremec T56 Magnum (2-bolt plate mount)	2.16 - 3.13**	60-6105
Ford	Top Loader (1 1/16 x 10 spline)	1.77 - 3.00*	60-6102
Ford	Borg-Warner /Tremec T5	1.77 - 3.00*	60-6104

*Height adjustment on included sleeve that fits onto tube of input shaft bearing retainer. Does not include height of retainer base.

**Height adjustment on included mounting base. Dimension is from mating face of transmission to top of bearing.

Installation drawing for 6000-Series HRBs is available at www.tiltonracing.com/technical/installation-drawings





6000-Series

Bearing Type: Radius-face
Contact Diameter: 2.00" (52mm)

Application	Transmission	Height Adjustment (inches)	Part Number
Chevy SB/BB	Tremec TKO/500/600	2.75 - 3.00**	60-6036
Chevy LS/LT	Tremec TKO/500/600	2.02 - 3.25*	60-6031
Chevy	Tremec T56 Magnum	2.41 - 3.38**	60-6035
Chevy	Tremec TR6060	2.91 - 3.88 **	60-6041
Chevy	Borg-Warner/Tremec T5	2.02 - 3.25*	60-6033
Ford	Tremec TKO/500/600	2.02 - 3.25*	60-6032
Ford	Tremec T56 Magnum (Pilot tube mount)	2.02 - 3.25*	60-6034
Ford	Tremec T56 Magnum (2-bolt plate mount)	2.54 - 3.51**	60-6035
Ford	Top Loader (1 1/16 x 10 spline)	2.02 - 3.25*	60-6032
Ford	Borg-Warner/Tremec T5	2.02 - 3.25*	60-6034

*Height adjustment on included sleeve that fits onto tube of input shaft bearing retainer. Does not include height of retainer base.

**Height adjustment on included mounting base. Dimension is form mating face of transmission to top of bearing.



6200-Series

Bearing Type: Radius-face
Contact Diameter: 1.75" (44mm)

Application	Transmission	Height Adjustment (inches)	Part Number
Chevy SB/BB	Tremec TKO/500/600	2.88 - 3.13**	60-6236
Chevy LS/LT	Tremec TKO/500/600	2.15 - 3.38*	60-6231
Chevy	Tremec T56 Magnum	2.54 - 3.51**	60-6235
Chevy	Tremec TR6060	2.66 - 3.63**	60-6241
Chevy	Borg-Warner/Tremec T5	2.15 - 3.38*	60-6233
Ford	Tremec TKO/500/600	2.15 - 3.38*	60-6232
Ford	Tremec T56 Magnum (Pilot tube mount)	2.15 - 3.38*	60-6234
Ford	Tremec T56 Magnum (2-bolt plate mount)	2.54 - 3.51*	60-6235
Ford	Top Loader (1 1/16 x 10 spline)	2.15 - 3.38*	60-6232
Ford	Borg-Warner/Tremec T5	2.15 - 3.38*	60-6234

*Height adjustment on included sleeve that fits onto tube of input shaft bearing retainer. Does not include height of retainer base.

**Height adjustment on included mounting base. Dimension is form mating face of transmission to top of bearing.



6300-Series

Bearing Type: Radius-face
Contact Diameter: 1.50" (38mm)

Application	Transmission	Height Adjustment (inches)	Part Number
Chevy SB/BB	Tremec TKO/500/600	2.88 - 3.13**	60-6336
Chevy LS/LT	Tremec TKO/500/600	2.15 - 3.38*	60-6331
Chevy	Tremec T56 Magnum	2.54 - 3.51**	60-6335
Chevy	Tremec TR6060	3.04 - 4.01**	60-6341
Chevy	Borg-Warner/Tremec T5	2.15 - 3.38*	60-6333
Ford	Tremec TKO/500/600	2.15 - 3.38*	60-6332
Ford	Tremec T56 Magnum (Pilot tube mount)	2.15 - 3.38*	60-6334
Ford	Tremec T56 Magnum (2-bolt plate mount)	2.54 - 3.51*	60-6335
Ford	Top Loader (1 1/16 x 10 spline)	2.15 - 3.38*	60-6332
Ford	Borg-Warner/Tremec T5	2.15 - 3.38*	60-6334

*Height adjustment on included sleeve that fits onto tube of input shaft bearing retainer. Does not include height of retainer base.

**Height adjustment on included mounting base. Dimension is form mating face of transmission to top of bearing.



Typical Applications

- Bulkhead-mounted inside transmission or bellhousing with adapter plate

Features

- **Mount Type:** 2-Bolt pattern
- **Piston Area:** 1.215in² (784mm²)
- **Max Stroke:** .600" (15.24mm)
- **Ports:** AN3 (3/8"-24 thread)
- **Weight:** .70 - .95 lbs (varies by model)



8000-Series		Bearing Type: Radius-face Contact Diameter: 2.05" (52mm)		
Part Number	Height*	Replacement Bearing	Replacement Piston	Seal Kit
60-8000	2.05" (52.0mm)	62-002	62-612	62-905



8100-Series		Bearing Type: Flat-face Contact Diameter: 1.71" - 2.83" (43.4mm - 71.9mm)		
Part Number	Height*	Replacement Bearing	Replacement Piston	Seal Kit
60-8100	1.79" (45.5mm)	62-618	62-6100	62-905



8200-Series		Bearing Type: Radius-face Contact Diameter: 1.75" (44mm)		
Part Number	Height*	Replacement Bearing	Replacement Piston	Seal Kit
60-8200	1.87" (47.5mm)	62-031	62-6000	62-905
60-8210	1.97" (50.0mm)	62-031	62-6001	62-905
60-8220	2.07" (52.3mm)	62-031	62-6002	62-905
60-8230	2.17" (55.1mm)	62-031	62-6003	62-905
60-8240	2.27" (57.7mm)	62-031	62-6004	62-905
60-8250	2.37" (60.2mm)	62-031	62-6005	62-905
60-8260	2.47" (62.7mm)	62-031	62-6006	62-905
60-8270	2.57" (65.3mm)	62-031	62-6007	62-905
60-8280	2.67" (67.8mm)	62-031	62-6008	62-905
60-8290	2.77" (70.4mm)	62-031	62-6009	62-905

*Height can be reduced by .050" (1.27mm) by removing the shim that is located under bearing within the piston



8300-Series		Bearing Type: Radius-face Contact Diameter: 1.50" (38mm)		
Part Number	Height*	Replacement Bearing	Replacement Piston	Seal Kit
60-8300	1.87" (47.5mm)	62-008	62-6000	62-905
60-8310	1.97" (50.0mm)	62-008	62-6001	62-905
60-8320	2.07" (52.3mm)	62-008	62-6002	62-905
60-8330	2.17" (55.1mm)	62-008	62-6003	62-905
60-8340	2.27" (57.7mm)	62-008	62-6004	62-905
60-8350	2.37" (60.2mm)	62-008	62-6005	62-905
60-8360	2.47" (62.7mm)	62-008	62-6006	62-905
60-8370	2.57" (65.3mm)	62-008	62-6007	62-905
60-8380	2.67" (67.8mm)	62-008	62-6008	62-905
60-8390	2.77" (70.4mm)	62-008	62-6009	62-905

*Height can be reduced by .050" (1.27mm) by removing the shim that is located under bearing within the piston



Typical Applications

- Bulkhead-mounted inside transmission or bellhousing with adapter plate



Features

- **Mount Type:** 2-Bolt Pattern
- **Piston Area:** 0.93in² (600mm²)
- **Max Stroke:** .600" (15.24mm)
- **Ports:** AN3 (3/8"-24 thread)
- **Weight:** .60 lbs

9000-Series		Bearing Type: Radius-face Contact Diameter: 1.75" (44mm)		
Part Number	Height*	Replacement Bearing	Replacement Piston	Seal Kit
61-9002	1.95" (49.5mm)	62-031	62-9800	62-9980
61-9012	2.02" (51.3mm)	62-031	62-9801	62-9980

Typical Applications

- Slip fit over release bearing pilot tube



Features

- **Mount Type:** Slip fit onto 1.375" (35mm) pilot tube
- **Piston Area:** 1.215in² (784mm²)
- **Max Stroke:** .500" (12.7mm)
- **Ports:** AN3 (3/8"-24 thread)
- **Weight:** .70 lbs

700-Series		Bearing Type: Radius-face Contact Diameter: 1.75" (44mm)		
Part Number	Height*	Replacement Bearing	Replacement Piston	Seal Kit
61-772	1.64" (41.7mm)	62-031	62-6204	62-614
61-777	1.70" (43.2mm)	62-031	62-6205	62-614



700-Series Honda B/K-Series Release Bearing Kits

Release bearing kits designed for work with Tilton 7.25" 2-plate clutch-flywheel-assemblies (CFA) for Honda B-Series and K-Series applications. Includes 700-Series HRB, 75-Series 3/4" bore master cylinder, master cylinder mount adapter, steel braided hose fittings.

Application	Part Number
Tilton 7.25" 2-plate cerametallic CFA, Honda B/K-Series	61-7770
Tilton 7.25" 2-plate carbon CFA, Honda B/K-Series	61-7720

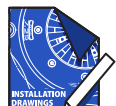



6000-Series HRB Mount Adapters

Mount adapters and collars designed to mount 6000-Series HRBs to transmission or bellhousing.

Description	Part Number
Adjustment sleeve, Chevy LS/LT, Tremec TKO/500/600	61-628
Adjustment sleeve, Ford, Tremec TKO500/600, T56 (pilot tube mount)	61-627
Adjustment sleeve, Universal (1.00" bore)	61-629
Mount adapter, adjustable height, Chevy, Tremec TKO 500/600	62-693
Mount adapter, adjustable height, Tremec T56 (2-bolt mount)	62-899
Mount Adapter, adjustable height, Tremec TR6060	62-900



8000-Series HRB Mount Adapters

Mount adapters and collars designed to mount 8000-Series HRBs to transmission or bellhousing.

Description	Part Number
Mount adapter, Porsche 993/996/997, G-50-type transmission, .200"	62-880
Mount adapter, Porsche 993/996/997, G-50-type transmission, .285"	62-882
Mount adapter, Tremec T56, .590"	62-874
Mount adapter, Tremec T56, 1.34"	62-877
Mount adapter, Tremec T56, 1.92"	62-898



9000-Series HRB Mount Adapters

Mount adapters and collars designed to mount 9000-Series HRBs to transmission or bellhousing.

Description	Part Number
Mount adapter, Mitsubishi EVO7/8/9/10	62-9900



Mechanical Release Bearings

Release bearings designed to work with OEM release bearings systems and Tilton 7.25" clutches.

Description	Part Number
Release bearing, BMW E36/E46 5-spd, Tilton 7.25" 1-plate cerametallic clutch/flywheel	62-020
Release bearing, BMW E36/E46 5-spd, Tilton 7.25" 2-plate cerametallic clutch/flywheel	62-021
Release bearing, BMW E36/E46 6-spd, Tilton 7.25" 2-plate cerametallic clutch/flywheel	62-022
Release bearing, Ford Mustang (1979-2004), Tilton 7.25" 2/3-plate clutch/flywheel	62-063
Release bearing, Honda B/K-Series, Tilton 2-Plate cerametallic & carbon clutch/flywheel	62-010



Replacement Bearings

Bearing Type	Applications	Part Number
38mm Radius-face	60-13xx, 60-23xx, 60-33xx, 60-43xx, 60-53xx, 60-63xx, 60-83xx HRBs	62-008
44mm Radius-face	60-12xx, 60-22xx, 60-32xx, 60-42xx, 60-52xx, 60-62xx, 60-82xx, HRBs	62-031
52mm Radius-face	60-1000, 60-3000, 60-3000, 60-4000, 60-5000, 60-60xx, 60-8000 HRBs	62-002
Flat-face	60-1100, 60-3100, 60-4100, 60-5100, 60-61xx, 60-8100 HRBs	62-618



Seal Kits

Applications	Part Number
60-1xxx, 60-2xxx, 60-3xxx, 60-4xxx, 60-5xxx, 60-6xxx, 60-8xxx HRBs	62-905
60-9002, 61-9012 HRBs	62-9980
61-772, 61-777	62-614



Pistons

Bearing Type	Length	Part Number
38mm & 44mm Radius-face bearings	1.215" (30.9mm)	62-6000
38mm & 44mm Radius-face bearings	1.315" (33.4mm)	62-6001
38mm & 44mm Radius-face bearings	1.415" (35.9mm)	62-6002
38mm & 44mm Radius-face bearings	1.515" (38.5mm)	62-6003
38mm & 44mm Radius-face bearings	1.615" (41.0mm)	62-6004
38mm & 44mm Radius-face bearings	1.715" (43.6mm)	62-6005
38mm & 44mm Radius-face bearings	1.815" (46.1mm)	62-6006
38mm & 44mm Radius-face bearings	1.915" (48.6mm)	62-6007
38mm & 44mm Radius-face bearings	2.015" (51.2mm)	62-6008
38mm & 44mm Radius-face bearings	2.115" (53.7mm)	62-6009
52mm Radius-face bearing	1.530" (38.9mm)	62-612
Flat-face bearing	1.240" (31.5mm)	62-6100



Hoses & Fittings

Description	Part Number
Steel braided hose, 6000-Series HRB, swivel-type	62-521
Snap ring for 62-521	5100-43
Bleed fitting assembly for 6000-Series HRB	62-522
AN3 union fitting	73-820

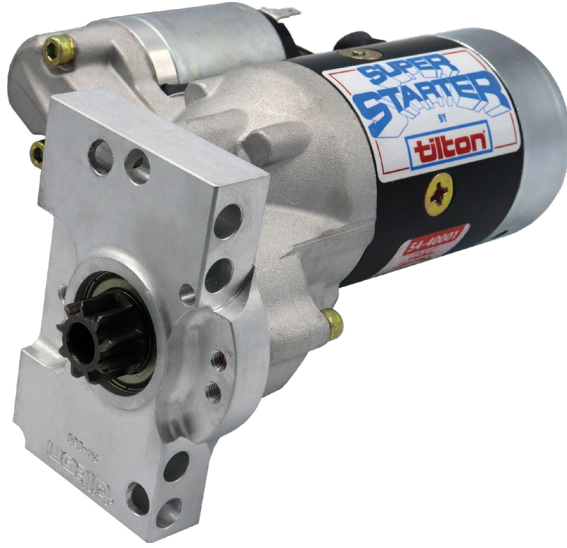

Features

- ▶ Powerful 3.0 HP motor and gear reduction provides high torque to start large, high compression engines.
- ▶ Precision machined components are held to critical tolerances, ensuring high performance and a perfect fit.
- ▶ Internal vibration damping and electrical insulation provide longevity and maximum performance.
- ▶ High-strength (grade 10.9) socket head fasteners ensure rigid assembly and easy access for hex keys.
- ▶ Serrated belleville lock washers are used to ensure fasteners stay in place through severe vibrations and heat cycles.
- ▶ Thread locking compound is used on all fasteners and are secured to precise torque specifications.

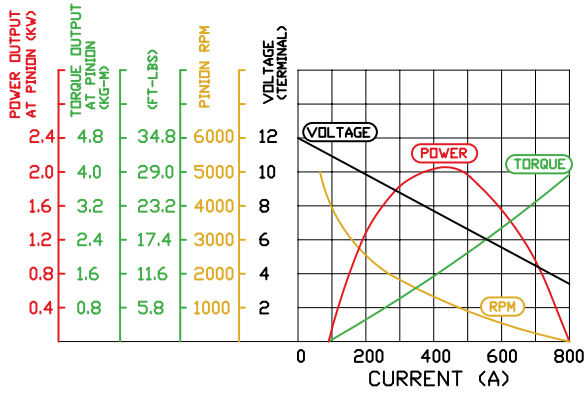

Motor Power: **3.0 HP (2.2 kW)**

Weight: **12.0 lbs**

Rec. Engine Size: **Up to 600 C.I.D.**

Rec. Compression Ratio: **Up to 18.0 : 1**

40000-Series Super Starter				
Application	Part Number	Replacement Solenoid	Replacement Drive Assembly	Replacement Pinion Kit
Bert/Brinn bellhousing	54-40040	54-422HD	54-043-044	54-043
Chevy V8, 153/168T RG	54-41001	54-422HD	54-421	54-442
Chevy V8, 153 /168T RG, reverse rotation	54-41001	54-422HD	54-421R	54-042R
Chevy LS/LSX/LT, 168T RG	54-40011	54-422HD	54-421	54-442
Chevy LS/LSX/LT, 153T RG	54-40012	54-422HD	54-421	54-442
Ford 289/302/351/390/427/428 (1967-up)	54-40013	54-422HD	54-421	54-442
Ford 351M/400/429/460	54-40014	54-422HD	54-421	54-442
Formula Ford, Hewland MK5/MK8, 110T RG	54-40030	54-422HD	54-020	54-443
Porsche 911/914/930 (pre-1989)	54-41061	54-422HD	54-421R	54-042R
QM Bellhousing, rear-mount, 110T RG	54-41052	54-422HD	54-421R	54-042R
Tilton 5.5" Bellhousing, rear-mount, 102T RG	52-41062	54-422HD	54-021R-13	54-042R-13
Tilton 5.5" Bellhousing, Rear-Mount, 99T RG	54-41072	54-422HD	54-421R	54-042R
Tilton 7.25" Bellhousing, rear-mount, 110T RG, 4 o' clock solenoid position	54-41547	54-422HD	Contact Tilton	Contact Tilton
Tilton 7.25" Bellhousing, rear-mount, 110T RG, 6 o' clock solenoid position	54-41047	54-422HD	Contact Tilton	Contact Tilton
Tilton 7.25" Bellhousing, rear-mount, 110T RG, 11 o' clock solenoid position	54-41647	54-422HD	Contact Tilton	Contact Tilton
VW-Type transaxle	54-41053	54-422HD	54-421R	54-042R

Installation drawing for 40000-Series Super Starter is available at www.tiltonracing.com/technical/installation-drawings





Features

- ▶ Lightweight yet powerful, the 1.6 HP motor provides fast torque to start high performance engines.
- ▶ Precision machined components are held to critical tolerances, ensuring high performance and a perfect fit.
- ▶ Internal vibration damping and electrical insulation provide longevity and maximum performance.
- ▶ High-strength (grade 10.9) socket head fasteners ensure rigid assembly and easy access for hex keys.
- ▶ Thread locking compound is used on all fasteners and are secured to precise torque specifications.

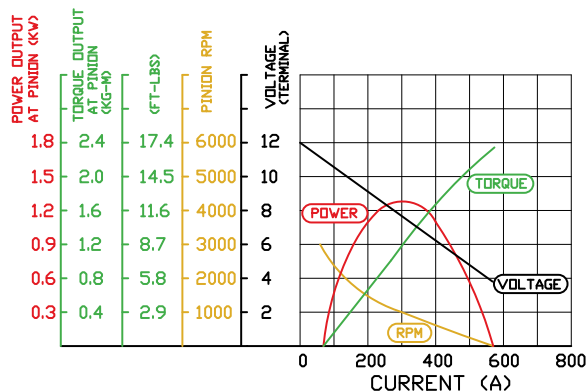

Motor Power: **1.6 HP (1.2 kW)**

Weight: **7.0 lbs**

Rec. Engine Size: **Up to 400 C.I.D.**

Rec. Compression Ratio: **Up to 10.5 : 1**

XLT-Series Super Starter				
Application	Part Number	Replacement Solenoid	Replacement Drive Assembly	Replacement Mounting Hose
Cosworth BDA, FT transaxle	54-50086	54-422PM	54-5410	54-586
Formula Ford, Hewland MK5/MK8, 110T RG	54-50030	54-422PM	54-5410	54-530
Tilton 7.25" bellhousing, rear-mount, 110T RG	54-61048	54-422PM	Contact Tilton	54-6016A
Universal, no mount nose, 9T, 10-Pitch	54-5110	54-422PM	54-5410	NA
Universal, no mount nose, 10T, 12-Pitch	54-5100	54-422PM	54-5400	NA

Installation drawing for XLT Super Starters is available at www.tiltonracing.com/technical/installation-drawings

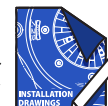



Intermittent Use Pumps

Pump Motor Duty Cycle: 1-2 hr with 15 minute cool down

P/N: 40-524 (Buna) | P/N: 40-525 (Viton)

Designed for applications where pump does not need to be used continuously, such as being turned on/off by the driver or by a relay at an established temperature. Options include Buna or Viton rubber diaphragm and check valve.



Continuous Duty Pumps

Pump Motor Duty Cycle: Up to 1000 hours continuous

P/N: 40-527 (Buna)

Designed for applications where the pump needs to operate continuously for longer than 2 hours at a time without cool down.

Tilton cooler pumps are ideal for pumping oil through transmission and differential coolers. They can also be used for many other applications, such as emptying fuel tanks or circulating coolant. Each pump features an internal bypass valve and is self-priming up to 8-ft above the source from which it draws. Tilton cooler pumps are a positive displacement type of pump, so their output is directly proportional to the motor speed. For example, if a lighter load increases the motor speed by 25%, then the flow rate increases by 25%.

Buna model

Designed for use with standard oils and coolants.

Viton model

Designed for use with corrosive fluids such as alcohol.

P/Ns: **See List**

Pump head ports: **3/8" NPT**

Recommended line size: **AN-8**

Smallest line size: **AN-4**

Flow Rate: **1-2 GPM (varies by load)**

Maximum Pressure: **50 PSI**

Continuous Duty Temp: **40° – 160° F (4° – 71° C)**

Intermittent Use Max Temp: **265° F (130° C)**

Power: **12-Volt DC**

Dimensions (L x W x H):

Intermittent Use Models: **7.63" x 3.93" x 3.62"**

Continuous Duty Model: **8.57" x 3.93" x 3.62"**

Weights:

Intermittent Use Models: **3.5 lbs. (1.6 kg)**

Continuous Duty Model: **5.5 lbs. (2.5 kg)**

Typical Applications

- ▶ Transmission Cooler
- ▶ Differential Cooler
- ▶ Coolant Distribution
- ▶ Fuel Tank/Line Flush

Cooler Pumps

Intermittent duty, Buna diaphragm	40-524
Intermittent duty, Viton diaphragm	40-525
Continuous duty, Buna diaphragm	40-527

Service Parts

Part Numbers

Diaphragm kit

Buna	40-902
Viton	40-912

Check valve assembly

Buna	40-934
Viton	40-935



600 series

Tilton 600-Series pedal assemblies are the benchmark for pedal assemblies of their type, offering great performance and value. 600-Series pedal assemblies are categorized by the use of a traditional spherical bearing type balance bar and flange mounted master cylinders.

600-Series pedal assemblies are available in **Firewall-mount**, **Floor-mount**, **Overhung** and **Underfoot** configurations.

Features

Lightweight forged aluminum pedals provide high-strength and rigidity.

Lightweight permanent mold cast aluminum frame feature guide ramps that minimizing balance bar "tipping" for improved performance.

7/16" diameter spherical bearing type balance bar minimizes flex and provides solid pedal feel. Aluminum clevises feature low friction coating for durability and smooth action.

Pedal pivots feature wave washers to reduce lateral pedal movement and oil-impregnated bronze bushings for smoother operation and long service life.

Adjustable pedal ratio.

Adjustable pedal pad positions.

Adjustable clutch and/or throttle stops limit pedal travel (most models).

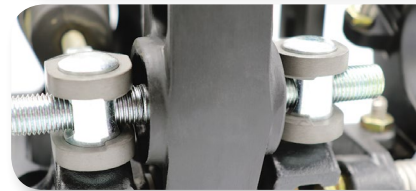



3-Pedal Underfoot (Clutch, Brake & Throttle)

Pedal Ratio: **5.4:1 – 6.9:1**

Pedal Pad Adjustment: **Horizontal, Vertical, Angle**

Weight*: **6.4 lbs (2.9 kg)**

Part Number: **72-616**



2-Pedal Underfoot (Clutch & Brake)

Pedal Ratio: **5.4:1 – 6.9:1**

Pedal Pad Adjustment: **Horizontal, Vertical, Angle**

Weight*: **5.0 lbs (2.3 kg)**

Part Number: **72-617**



2-Pedal Underfoot (Brake & Throttle)

Pedal Ratio: **5.0:1 - 6.2:1**

Pedal Pad Adjustment: **Horizontal, Vertical, Angle**

Weight*: **4.6 lbs (2.2 kg)**

Part Number: **72-618**

**Does not include master cylinders*

Accessories

Description	Part Number
Throttle linkage kit, drive-by-wire (sensor not included)	72-794
Throttle linkage kit, mechanical type	72-793
Clevis, for use with throttle cables with 10-32 threaded end	72-797
Master cylinder, 76-Series	See page 62 for options
Remote brake bias adjuster	See page 66 for options
Replacement pedal pad with anti-slip tape, narrow	72-6035
Replacement pedal pad with anti-slip tape, wide	72-6034
Replacement anti-slip tape, narrow	72-9014
Replacement anti-slip tape, wide	72-9026

Installation drawing for 600-Series Underfoot Pedal Assembly is available at www.tiltonracing.com/technical/installation-drawings





◀ **3-Pedal Floor-mount**
(Clutch, Brake & Throttle)

Pedal Ratio: **5.3:1 - 5.8:1**

Pedal Pad Adjustment: **Horizontal, Vertical**

Weight*: **5.5 lbs (2.5 kg)**

Part Number: **72-603**



◀ **2-Pedal Underfoot**
(Clutch & Brake)

Pedal Ratio: **5.3:1 - 5.8:1**

Pedal Pad Adjustment: **Horizontal, Vertical**

Weight*: **4.6 lbs (2.1 kg)**

Part Number: **72-604**

**Does not include master cylinders*

Accessories

Description	Part Number
Throttle linkage kit, drive-by-wire (sensor not included)	72-792
Throttle linkage kit, mechanical type	72-791
Clevis, for use with throttle cables with 10-32 threaded end	72-797
Master cylinder, 76-Series	See page 62 for options
Master cylinder, 75-Series	See page 62 for options
Master cylinder, 74-Series	See page 63 for options
Master cylinder, 73-Series	See page 63 for options
Reservoir brake bias adjuster	See page 66 for options
Reservoir	See page 65 for options
Replacement pedal pad with anti-slip tape, narrow	72-6035
Replacement pedal pad with anti-slip tape, wide	72-6034
Replacement anti-slip tape, narrow	72-9014
Replacement anti-slip tape, wide	72-9026

Installation drawing for 600-Series Floor-mount Pedal Assembly is available at www.tiltonracing.com/technical/installation-drawings

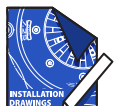



2-Pedal Firewall-mount (Clutch & Brake)

Pedal Ratio: **5.0:1 – 6.2:1**

Pedal Pad Adjustment: **Horizontal, Vertical, Angle**

Weight*: **4.8 lbs (2.2 kg)**

Part Number: **72-607**



2-Pedal Overhung (Clutch & Brake)

Pedal Ratio: **5.0:1 - 6.2:1**

Pedal Pad Adjustment: **Horizontal, Vertical, Angle**

Weight*: **4.8 lbs (2.2 kg)**

Part Number: **72-608**



Throttle Pedal

Shown with optional P/N 72-791 throttle linkage kit

Pedal Ratio: **5.0:1 - 6.2:1**

Pedal Pad Adjustment: **Horizontal, Vertical, Angle**

Weight*: **1.7 lbs (0.8 kg)**

Part Number: **72-615**

**Does not include master cylinders*

Accessories

Description	Part Number
Throttle linkage kit, drive-by-wire (sensor not included)	72-792
Throttle linkage kit, mechanical type	72-791
Clevis, for use with throttle cables with 10-32 threaded end	72-797
Master cylinder, 76-Series	See page 62 for options
Master cylinder, 75-Series	See page 62 for options
Master cylinder, 74-Series	See page 63 for options
Master cylinder, 73-Series	See page 63 for options
Remote brake bias adjuster	See page 66 for options
Reservoir	See page 65 for options
Replacement pedal pad with anti-slip tape, narrow	72-9035
Replacement pedal pad with anti-slip tape, wide	72-9034
Replacement anti-slip tape, narrow	72-9014
Replacement anti-slip tape, wide	72-9026



800 SERIES

Tilton 800-Series pedal assemblies merge the performance of Tilton's 900-Series pedal assemblies with the renowned value of Tilton's 600-Series pedal assemblies. 800-Series pedal assemblies are categorized by use of a high-efficiency spherical bearing type balance bar, combined with pivot-mount master cylinders for the brakes, limits balance bar motion to the horizontal plane to reduce brake pressure migration issues. All 800-Series pedal assemblies, except for Underfoot assemblies, utilize a traditional flange-mount master cylinder to help reduce costs.

800-Series pedal assemblies are available in **Firewall-mount**, **Floor-mount**, **Overhung** and **Underfoot** configurations. Underfoot configurations are also available with an optional slide system for quick pedal assembly position changes.

Features

Lightweight forged aluminum pedals provide high-strength and rigidity.

Lightweight permanent mold cast aluminum frame.

High-efficiency 7/16" balance bar, combined with pivot-mount master cylinders, limits motion to the horizontal plane to reduce brake pressure migration issues.

Pedal pivots feature wave washers to reduce lateral pedal movement and oil-impregnated bronze bushings for smoother operation and long service life.

Adjustable pedal ratio.

Adjustable pedal pad positions.

Adjustable clutch and/or throttle stops limit pedal travel (most models).





3-Pedal Underfoot (Clutch, Brake & Throttle)

Pedal Ratio: **4.8:1 - 6.1:1**

Pedal Pad Adjustment: **Horizontal, Vertical, Angle**

Weight*: **7.6 lbs (3.5 kg)**

Part Number: **72-856**



2-Pedal Underfoot (Clutch & Throttle)

Pedal Ratio: **4.8:1 - 6.1:1**

Pedal Pad Adjustment: **Horizontal, Vertical**

Weight*: **6.2 lbs (2.8 kg)**

Part Number: **72-857**

**Does not include master cylinders*

Accessories



Optional false floor kit (72-853-FF)

Description	Part Number
False floor kit	72-853-FF
Throttle linkage kit, drive-by-wire (sensor not included)	72-794
Throttle linkage kit, mechanical type	72-793
Clevis, for use with throttle cables with 10-32 threaded end	72-797
Master cylinder, 78-Series pivot mount	See page 61 for options
Master cylinder, 79-Series pivot mount, ABS compatible	See page 61 for options
Remote brake bias adjuster	See page 66 for options
Reservoir	See page 65 for options
Replacement pedal pad with anti-slip tape, narrow	72-9035
Replacement pedal pad with anti-slip tape, wide	72-9034
Replacement anti-slip tape, narrow	72-9014
Replacement anti-slip tape, wide	72-9026

Installation drawing for 850-Series Underfoot (non-slider) Pedal Assembly is available at www.tiltonracing.com/technical/installation-drawings





3-Pedal Underfoot (Clutch, Brake & Throttle)

Pedal Ratio: **4.8:1 - 6.1:1**

Pedal Pad Adjustment: **Horizontal, Vertical, Angle**

Pedal Assembly Adjustment: **14-position (7" total travel; 1/2" increments)**

Weight*: **14.4 lbs (6.5 kg)**

Part Number: **72-850**



2-Pedal Underfoot (Clutch & Brake)

Pedal Ratio: **4.8:1 - 6.1:1**

Pedal Pad Adjustment: **Horizontal, Vertical, Angle**

Pedal Assembly Adjustment: **14-position (7" total travel; 1/2" increments)**

Weight*: **13.0 lbs (5.9 kg)**

Part Number: **72-851**

**Does not include master cylinders*



72-850 included false floor

Accessories

Description	Part Number
Throttle linkage kit, drive-by-wire (sensor not included)	72-794
Throttle linkage kit, mechanical type	72-793
Clevis, for use with throttle cables with 10-32 threaded end	72-797
Master cylinder, 78-Series pivot mount	See page 61 for options
Master cylinder, 79-Series pivot mount, ABS compatible	See page 61 for options
Remote brake bias adjuster	See page 66 for options
Reservoir	See page 65 for options
Replacement pedal pad with anti-slip tape, narrow	72-6035
Replacement pedal pad with anti-slip tape, wide	72-6034
Replacement anti-slip tape, narrow	72-9014
Replacement anti-slip tape, wide	72-9026

Installation drawing for 850-Series Underfoot (slider) Pedal Assembly is available at www.tiltonracing.com/technical/installation-drawings

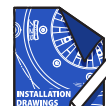



3-Pedal Floor-mount (Clutch, Brake & Throttle)

Pedal Ratio: **5.3:1 - 6.8:1**

Pedal Pad Adjustment: **Horizontal, Vertical**

Weight*: **6.3 lbs (2.8 kg)**

Part Number: **72-803**



2-Pedal Underfoot (Clutch & Brake)

Pedal Ratio: **5.3:1 - 5.8:1**

Pedal Pad Adjustment: **Horizontal, Vertical**

Weight*: **5.3 lbs (2.4 kg)**

Part Number: **72-804**

**Does not include master cylinders*

Accessories

Description	Part Number
Throttle linkage kit, drive-by-wire (sensor not included)	72-792
Throttle linkage kit, mechanical type	72-791
Clevis, for use with throttle cables with 10-32 threaded end	72-797
Master cylinder, 76-Series (clutch)	See page 62 for options
Master cylinder, 78-Series pivot mount (brakes)	See page 61 for options
Master cylinder, 79-Series pivot mount, ABS compatible (brakes)	See page 61 for options
Remote brake bias adjuster	See page 66 for options
Reservoir	See page 65 for options
Replacement pedal pad with anti-slip tape, narrow	72-6035
Replacement pedal pad with anti-slip tape, wide	72-6034
Replacement anti-slip tape, narrow	72-9014
Replacement anti-slip tape, wide	72-9026

Installation drawing for 800-Series Floor-Mount Pedal Assembly is available at www.tiltonracing.com/technical/installation-drawings





◀ **2-Pedal Firewall-mount**
(Clutch, Brake & Throttle)

Pedal Ratio: **5.0:1 - 6.2:1**

Pedal Pad Adjustment: **Horizontal, Vertical, Angle**

Weight*: **5.5 lbs (2.5 kg)**

Part Number: **72-807**



◀ **2-Pedal Overhung**
(Clutch & Brake)

Pedal Ratio: **5.0:1 - 6.2:1**

Pedal Pad Adjustment: **Horizontal, Vertical, Angle**

Weight*: **5.5 lbs (2.5 kg)**

Part Number: **72-808**



◀ **Throttle Pedal**
Shown with optional P/N 72-791 throttle linkage kit

Pedal Ratio: **5.0:1 - 6.2:1**

Pedal Pad Adjustment: **Horizontal, Vertical, Angle**

Weight*: **1.7 lbs (0.8 kg)**

Part Number: **72-615**

**Does not include master cylinders*

Accessories

Description	Part Number
Throttle linkage kit, drive-by-wire (sensor not included)	72-792
Throttle linkage kit, mechanical type	72-791
Clevis, for use with throttle cables with 10-32 threaded end	72-797
Master cylinder, 76-Series (clutch)	See page 62 for options
Master cylinder, 78-Series pivot mount (brakes)	See page 61 for options
Master cylinder, 79-Series pivot mount, ABS compatible (brakes)	See page 61 for options
Remote brake bias adjuster	See page 66 for options
Reservoir	See page 65 for options
Replacement pedal pad with anti-slip tape, narrow	72-6035
Replacement pedal pad with anti-slip tape, wide	72-6034
Replacement anti-slip tape, narrow	72-9014
Replacement anti-slip tape, wide	72-9026

Installation drawing for 800-Series Overhung/Firewall Pedal Assembly is available at www.tiltonracing.com/technical/installation-drawings

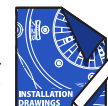



900 SERIES

Tilton 900-Series pedal assemblies provide the ultimate in racing pedal assembly technology, optimized to provide maximum braking performance and weigh savings. 900-Series pedal assemblies are categorized by the use of an ultra-efficient trunion type balance bar, combined with pivot-mount brake master cylinders, to virtually eliminate brake pressure migration issues. In addition, pedal frame and pedals are machined from billet aluminum for maximum weight savings.

900-Series pedal assemblies are available in **Firewall-mount**, **Floor-mount**, and **Overhung** configurations.

Features

Lightweight billet aluminum pedals provide high-strength and rigidity.



Lightweight one-piece billet aluminum frame.



Trunion-type balance bar features needle bearings at all pivots, providing the highest level of efficiency and smooth operation.



Pedal pivots feature needle bearing and/or ball bearings for the ultimate in smooth operation and service life.



Adjustable pedal ratio.



Adjustable pedal pad positions.



Adjustable clutch and/or throttle stops limit pedal travel (most models).

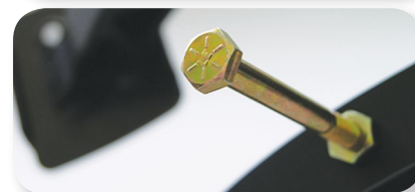



◀ 3-Pedal Floor-mount
(Clutch & Brake Throttle)

Pedal Ratio: **4.5:1 - 5.8:1**

Pedal Pad Adjustment: **Horizontal, Vertical**

Weight*: **5.0 lbs (2.3 kg)**

Part Number: **72-903**



◀ 2-Pedal Overhung
(Clutch & Brake)

Pedal Ratio: **4.5:1 - 5.8:1**

Pedal Pad Adjustment: **Horizontal, Vertical**

Weight*: **4.4 lbs (2.0 kg)**

Part Number: **72-902**



◀ 2-Pedal Firewall-mount
(Clutch & Brake)

Pedal Ratio: **5.0:1 - 6.2:1**

Pedal Pad Adjustment: **Horizontal, Vertical**

Weight*: **4.9 lbs (2.2 kg)**

Part Number: **72-901**

**Does not include master cylinders*

Accessories

Description	Part Number
Throttle linkage kit for 72-903, drive-by-wire (sensor not included)	72-792
Throttle linkage kit for 72-903, mechanical type	72-791
Clevis, for use with throttle cables with 10-32 threaded end	72-797
Firewall Plate Kit for use with 72-901	72-799
Master cylinder, 78-Series pivot mount (clutch or brakes)	See page 61 for options
Master cylinder, 79-Series pivot mount, ABS compatible (brakes)	See page 61 for options
Remote brake bias adjuster	See page 66 for options
Reservoir	See page 65 for options

Installation drawing for 900-Series Floor-mount/Overhung/Firewall Assembly is available at www.tiltonracing.com/technical/installation-drawings





Features

- ABS compatible
- Spherical bearing mount with one-piece pushrod/piston eliminates side thrust loads on bore to provide long service life and consistent braking
- Billet aluminum body with low-friction coating
- Hand-built and blueprinted for cutoff port travel
- 1.1" stroke
- AN3 outlet port
- AN4 o-ring seal inlet port swivel fitting (sold separately)
- Fits Tilton [800-Series](#) and [900-Series](#) pedal assemblies/balance bars



Features

- Spherical bearing mount with one-piece pushrod/piston eliminates side thrust loads on bore to provide long service life and consistent braking
- Billet aluminum body with low-friction coating
- Hand-built and blueprinted for cutoff port travel
- 1.1" stroke
- AN3 outlet port
- 9/16"-18 inlet port
- Fits Tilton [800-Series](#) and [900-Series](#) pedal assemblies/balance bars

79-Series Master Cylinder

Spherical bearing-mount master cylinder specifically designed for use with ABS systems. Unlike traditional master cylinders, 79-Series master cylinders do not utilize a conventional cut-off port, and instead, feature a unique port strategy with a mechanically opened cut-off/compensation path. This design greatly reduces the chance of seal damage caused by high pressure pulsations sent back to the master cylinder by the ABS system.

Description	Part Number
79-Series master cylinder, 5/8" (15.88mm) bore	79-625
79-Series master cylinder, 7/10" (17.78mm) bore	79-700
79-Series master cylinder, 3/4" (19.05mm) bore	79-750
79-Series master cylinder, 13/16" (20.64mm) bore	79-812
79-Series master cylinder, 7/8" (22.23mm) bore	79-875
Inlet adapter, swivel type AN4 male end	79-523

78-Series Master Cylinder

Lightweight and compact spherical bearing-mount master cylinder. Direct replacement to Tilton 77-Series master cylinders

Description	Part Number
78-Series master cylinder, 5/8" (15.88mm) bore	78-625
78-Series master cylinder, 7/10" (17.78mm) bore	78-700
78-Series master cylinder, 3/4" (19.05mm) bore	78-750
78-Series master cylinder, 13/16" (20.64mm) bore	78-812
78-Series master cylinder, 7/8" (22.23mm) bore	78-875
78-Series master cylinder, 15/16" (23.81mm) bore	78-937
78-Series master cylinder, 1" (25.40mm) bore	78-1000
Inlet adapter, straight, 9/16"-18 to AN4 male	77-015
Inlet adapter, banjo type, 9/16"-18 to AN4 male	78-3400



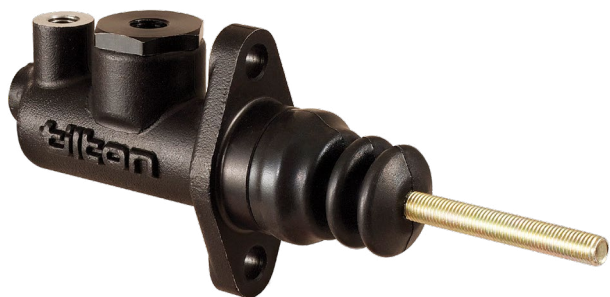

76-Series Master Cylinder

Compact flange-mount master cylinder features dual outlet port options and a 7/16"-20 inlet port. Inlet port adapter can be removed to fit Tilton direct-mount reservoir (P/N 74-240)

Features

- Flange-mount onto pedal assemblies with 2.25" center-to-center mounting studs
- Aluminum alloy body is black anodized for corrosion resistance
- 1.1" stroke
- Dual AN3 outlet port options (rear & top). Top outlet port is deep for use with most banjo fittings. Rear outlet port is standard depth AN3 spec.
- 7/16"-20 inlet port
- Fits Tilton [600-Series](#) and [800-Series](#) (clutch only) pedal assemblies/balance bars

Description	Part Number
76-Series master cylinder, 5/8" (15.88mm) bore	76-625
76-Series master cylinder, 7/10" (17.78mm) bore	76-700
76-Series master cylinder, 3/4" (19.05mm) bore	76-750
76-Series master cylinder, 13/16" (20.64mm) bore	76-812
76-Series master cylinder, 7/8" (22.23mm) bore	76-875
76-Series master cylinder, 1" (25.40mm) bore	76-1000
Direct mount reservoir, 5.3 oz (158ml)	74-240



75-Series Master Cylinder

Compact flange-mount universal master cylinder kit. Universal kit includes 6.8 oz reservoir, remote mount reservoir components and fittings.

Features

- Flange-mount onto pedal assemblies with 2.25" center-to-center mounting studs
- Aluminum alloy body is black anodized for corrosion resistance
- 1.1" stroke
- AN3 outlet port
- Direct mount or remote-mount reservoir options
- Fits Tilton [600-Series](#) and [800-Series](#) (clutch only) pedal assemblies/balance bars

Description	Universal Master Cylinder Kit	Master Cylinder Only
75-Series master cylinder, 5/8" (15.88mm) bore	75-625U	75-625
75-Series master cylinder, 7/10" (17.78mm) bore	75-700U	75-700
75-Series master cylinder, 3/4" (19.05mm) bore	75-750U	75-750
75-Series master cylinder, 13/16" (20.64mm) bore	75-812U	75-812
75-Series master cylinder, 7/8" (22.23mm) bore	75-875U	75-875
75-Series master cylinder, 1" (25.40mm) bore	75-1000U	75-1000



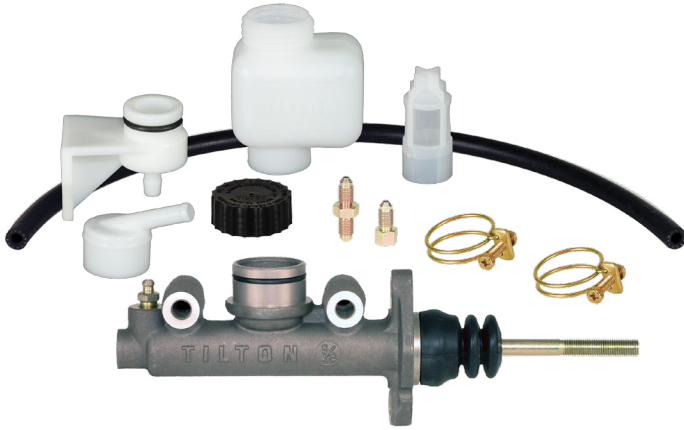

Features

- Flange-mount onto pedal assemblies with 2.25" center-to-center mounting studs
- 3.00" center-to-center side mount option
- Aluminum alloy body is clear anodized for corrosion resistance
- 1.1" stroke
- Dual AN3 outlet port options. Includes bleed screw installed into top port.
- Direct mount or remote-mount reservoir options
- Fits Tilton 600-Series pedal assemblies/balance bars

Description	Universal Master Cylinder Kit	Master Cylinder Only
74-Series master cylinder, 5/8" (15.88mm) bore	74-625U	74-625
74-Series master cylinder, 7/10" (17.78mm) bore	74-700U	74-700
74-Series master cylinder, 3/4" (19.05mm) bore	74-750U	74-750
74-Series master cylinder, 13/16" (20.64mm) bore	74-812U	74-812
74-Series master cylinder, 7/8" (22.23mm) bore	74-875U	74-875
74-Series master cylinder, 1" (25.40mm) bore	74-1000U	74-1000
74-Series master cylinder, 1 1/8" (28.58mm) bore	74-1125U	74-1125

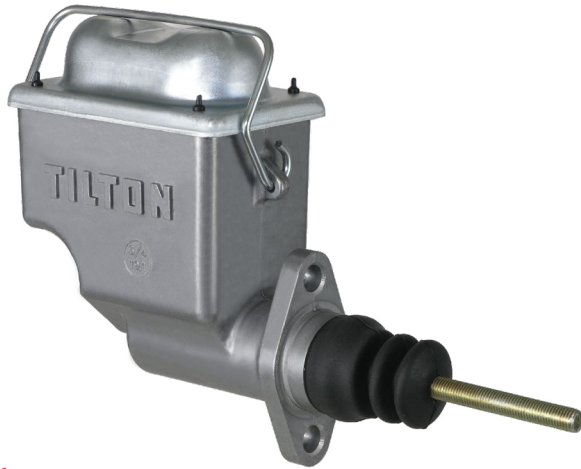

Features

- Flange-mount onto pedal assemblies with 2.25" center-to-center mounting studs
- High pressure die-cast aluminum alloy body provides machined-look finish
- Integral 10 oz reservoir feature an expanding bellow to keep elements away from brake fluid
- 1.1" stroke
- 1/8" NPT outlet port
- Fits Tilton 600-Series pedal assemblies/balance bars

74-Series Master Cylinder

Continuously improved since their introduction in 1986, the venerable 74-Series universal master cylinder kits have become a trusted favorite of car builders and race teams due to their reliability and value. Universal kit includes 6.8 oz reservoir, remote mount reservoir components and fittings.

73-Series Master Cylinder

Designed for applications that require large fluid capacity in a leak-proof integral reservoir. 10 oz fluid chamber is completely sealed from the outside environment while still allowing fluid level changes.

Description	Part Number
73-Series master cylinder, 3/4" (19.05mm) bore	73-750
73-Series master cylinder, 7/8" (22.23mm) bore	73-875
73-Series master cylinder, 1" (25.40mm) bore	73-1000





Master Cylinder Rebuild Kits

Includes master cylinder internals and dust boot

Bore Size	74-Series	75-Series	76-Series	78-Series	79-Series
5/8" (15.88mm)	74-625RK	75-625RK	76-625RK	78-625RK	79-625RK
7/10" (17.78mm)	74-700RK	75-700RK	76-700RK	78-700RK	79-700RK
3/4" (19.05mm)	74-750RK	75-750RK	76-750RK	78-750RK	79-750RK
13/16" (20.64mm)	74-812RK	75-812RK	76-812RK	78-812RK	79-812RK
7/8" (22.23mm0)	74-875RK	75-875RK	76-875RK	78-875RK	79-875RK
15/16" (23.81mm)	N/A	N/A	N/A	78-937RK	N/A
1" (25.40mm)	74-1000RK	75-1000RK	76-1000RK	78-1000RK	N/A
1 1/8" (28.58mm)	74-1125RK	75-1125RK	N/A	N/A	N/A



Master Cylinder Service Parts

Description	Label	74-Series	75-Series	76-Series
Reservoir, 4.0 oz	A	74-202	74-202	N/A
Reservoir, 6.8 oz	B	74-203	74-203	N/A
Reservoir, 10.7 oz	C	74-204	74-204	N/A
Filter, 4.0 and 6.8 oz reservoirs	D	74-210	74-210	N/A
Filter, 10.7 oz reservoirs	E	74-211	74-211	N/A
Cap, reservoir	F	74-207	74-207	N/A
Clamp, reservoir	G	74-208	74-208	N/A
O-ring, master cylinder/reservoir	N/A	74-212-B	74-212-A	N/A
Pushrod	N/A	74-400	75-030	75-030
Remote reservoir mount bracket with o-ring	H	74-212	74-212	N/A
Remote inlet adapter	I	74-200	74-200	N/A
O-ring, remote mount bracket	N/A	74-212-A	74-212-A	N/A
Hose kit, 96", incl. 6 clamps	N/A	74-221	74-221	N/A
Hose 24"	J	74-214	74-214	N/A
Hose, bulk, sold by the foot	N/A	72-502	72-502	N/A
Fitting, union, AN3 male/male	K	73-820	73-820	73-820
Fitting, AN3 male to 3/16" female	L	TE2089-188L	TE2089-188L	N/A
Bleedscrew, AN3	N/A	28696	N/A	N/A

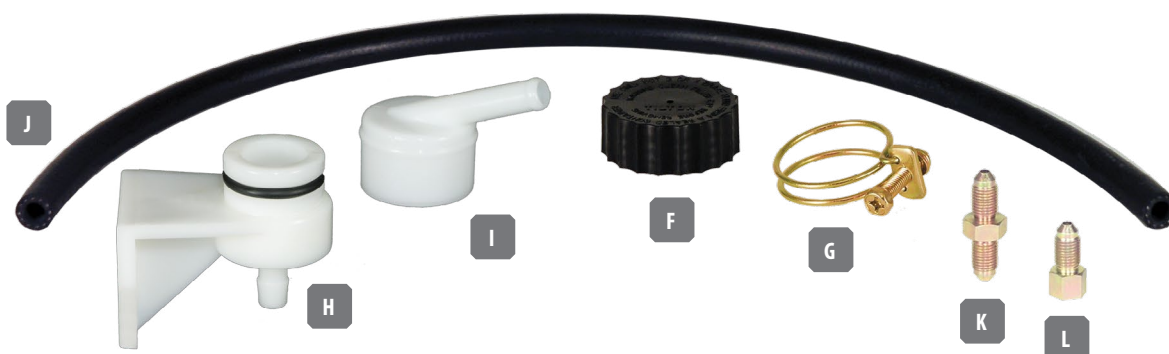



Features

- Fiberglass reinforced nylon body
- Gasket-sealed removable lid allows for easy cleaning
- Reservoir lid features safety screens to prevent foreign objects from falling into chambers
- Leak-proof baffle design insures that fluid remains in reservoir
- Standard capacity and low profile options available for AN4 type reservoirs

3-Chamber Reservoirs

Incorporates the clutch, front brake and rear brake fluid reservoirs into one convenient package. 2-hole mount provides simple installation onto firewall/bulkhead. The three separate internal chambers allow for complete evacuation of one chamber without affecting the remaining two chambers. Standard capacity reservoirs are available with either hose-barb or AN4 fitting connection. Low profile reservoirs is only available with AN4 fitting connection.

Reservoir Type	Rear Brake Chamber	Front Brake Chamber	Clutch Chamber
Standard Capacity	8.9 oz (263ml)	10.3 oz (313 ml)	4.6 oz (136 ml)
Low Profile	4.0 oz (117ml)	6.1 oz (182 ml)	2.0 oz (59ml)

Description	Part Number
3-chamber reservoir, standard capacity, hose barb connection	72-576
3-chamber reservoir, standard capacity, AN4 connection	72-577
3-chamber reservoir, low profile, AN4 connection	72-578
Hose kit for 72-576 reservoir, includes 96" of hose and 6 hose clamps	72-221
Replacement cap, less baffle	72-576-6
Replacement baffle for cap, funnel type	72-576-4
Replacement lid gasket	72-576-3



Single Chamber Reservoirs

Single chamber reservoirs with 5.3 oz (158 ml) fluid capacity. Available with AN4 fitting for remote-mount applications or with a 15/16"-20 adapter for direct mounting onto Tilton 76-Series master cylinders. Includes filter.

Description	Part Number
3-chamber reservoir, standard capacity, hose barb connection	74-230
3-chamber reservoir, standard capacity, AN4 connection	74-240
Replacement cap	72-207
Replacement filter	74-211

Remote Brake Bias Adjuster

Designed to enable remote front & rear brake bias adjustments by driver during competition. Standard model feature a plastic adjustment knob (red or yellow) with two spring-loaded nylon plungers on a stamped detent plate. Premium model features a billet aluminum knob and bulkhead-mount housing which incorporates dual detent system, with spring loaded steel ball bearings, for smooth and precise action. All models a high-quality 6-foot cable housed in a "wind up" resistant tubing. Includes couplers to fit 3/8"-24 and 7/16"-20 balance bars.

Description	Part Number
Remote brake bias adjuster, standard model, yellow knob	72-508
Remote brake bias adjuster, standard model, red knob	72-509
Remote brake bias adjuster, premium model, black	72-408



90 Degree Couplers

Designed to connect remote brake bias adjusters to balance bars at a 90 degree angle. This enables the adjuster's cable to be routed from the rear so it does not interfere with the clutch or throttle pedal.

Description	Part Number
90 degree coupler, 3/8"-24 balance bars	72-560
90 degree coupler, 7/16"-20 balance bars	72-561



Brake Proportioning Valves

Designed to reduce brake line pressure to a particular wheel or wheels. Maximum line pressure decrease is approximately 60%. Features a billet aluminum body that can either bulkhead or panel mounted. Lever-type proportioning valves features 7 pre-determined pressure reduction settings. Screw-type proportioning valves provide fine pressure reduction adjustments. Available with AN3 ports or 10mm x 1.0 ports.

Description	Part Number
Proportioning valve, lever-type, AN3 ports	90-1000
Proportioning valve, lever-type, 10mm x 1.0 ports	90-1003
Proportioning valve, screw-type, AN3 ports	90-2000
Portioning valve, screw-type, 10mm x 1.0 ports	90-2003
Rebuild kit for portioning valve	90-1100



Flow Control Valve

Designed to reduce shock to the driveline by allowing the clutch to slip slightly during engagement. Fluid flow is not restricted during clutch disengagement. Therefore, shift times are still quick and pedal feel does not change. Includes three orifice sizes (.021, .028" & .040") that enables clutch engagement to be tuned.

Description	Part Number
Flow control valve, AN3 fittings	90-5000
Replacement orifice, .021"	90-5100-021
Replacement orifice, .028"	90-5100-028
Replacement orifice, .040"	90-5100-040





Master Cylinder Bore Sizing Form

Please provide all the information listed on the form below. Email or fax the completed form to Tilton. This information will be used for calculation purposes so that we can make the best suggestion for master cylinder bore sizing. For best results, the most accurate information needs to be provided.

Note: Please note that the master cylinder suggestions provided by Tilton are predictions based upon calculations and should be taken as an estimated starting point only. They are not guaranteed. The vehicle should be tested at slow speeds in a controlled environment to confirm braking performance. If needed after testing, further suggestions can then be given based upon your feedback.

GENERAL INFO BRAKE SYSTEM CONTACT

Name: _____

Company: _____

Telephone number: _____

Email address: _____

Vehicle Make/Model: _____

Front Brake Details

Rear Brake Details:

Number of pistons within each front caliper: _____

Number of pistons within each rear caliper: _____

Are pistons on one side or both sides of caliper: _____

Are pistons on one side or both sides of caliper: _____

Diameter of pistons on one side of caliper (list all): _____

Diameter of pistons on one side of caliper (list all): _____

Piston 1: _____ Piston 2: _____

Piston 1: _____ Piston 2: _____

Piston 3: _____ Piston 4: _____

Piston 3: _____ Piston 4: _____

Front rotor diameter: _____

Rear rotor diameter: _____

ABS (Yes or No): _____

ABS Manufacturer: _____

What is the motion ratio of your brake pedal (5.5:1, 6.2:1, etc)? _____

OR If using a Tilton pedal assembly, please provide part number: _____

Vehicle weight (with driver and fuel): _____

Vehicle Weight Distribution (with driver and fuel): Front % _____ Rear % _____

Vehicle wheelbase: _____

Preferred pedal effort (85, 100 or 110 lbs): _____

Front tire diameter (outer): _____

Rear tire diameter (outer): _____

Type of tire (brand, model/compound): _____

What is the vehicle being used for (street, road racing, circle track, drag, etc)?: _____

FAX: 805.688.2745 // **EMAIL:** sales@tiltonracing.com

Where to Buy?

Tilton products are sold through a worldwide network of [dealers](#). For information on where to buy Tilton products, or for a list of Tilton dealers, please contact us: **web:** www.tiltonracing.com **email:** sales@tiltonracing.com **phone:** 805.688.2353.

We can direct you to a dealer that is near you and/or stocks the product you are looking for.

Note: Tilton will sell service parts or replacements parts not typically stocked by Tilton dealers directly to customers.

Technical Support

Tilton offers top-level technical support to customers, before and after the sale. Our technical support staff is very experienced, most with 20+ years at Tilton. For technical support, please contact us: **email:** technical@tiltonracing.com **phone:** 805.688.2353

Custom Parts

Tilton does make custom parts on a made-to-order basis. These parts are sold directly through Tilton. For further information on custom part orders, please contact us: **email:** sales@tiltonracing.com **phone:** 805.688.2353

Service

Tilton offers rebuild services on most of their products. We require that a Return Merchandise Authorization (RMA) number be obtained prior to sending products to Tilton for service. To obtain an RMA number, please contact us: **email:** sales@tiltonracing.com **phone:** 805.688.2353

Limited Warranty

There is no warranty stated or implied, due the unusual stresses placed on racing/performance parts and because we have no control over how they are used. This warranty is in lieu of all other warranties expressed or implied, including the warranty of merchantability and fitness for use and all other obligations or liabilities on the Company's part. The obligation of TILTON ENGINEERING under this warranty shall be limited to the part or parts shown to be defective and the Company will not be responsible for any damage or loss caused by delays, failures or any consequential damage arising from any cause whatsoever, nor for labor, transportation or any other charges incurred in the replacement or repair of said defective part or parts.

This warranty to repair or replace is the only warranty expressed, implied or statutory on which the buyer purchases the Company's products. All other damages and warranties, statutory or otherwise, being expressly waived by the buyer.

TILTON ENGINEERING's warranty will not be in force for any merchandise which has not been paid for in full to the Company, or which has been subject to accident, negligence, alteration, abuse or misuse. The Company makes no warranty whatsoever with respect to accessories or parts not supplied by TILTON ENGINEERING.

TILTON ENGINEERING neither assumes, nor authorizes any person to assume for it, any other liability except as otherwise expressly provided for herein, in connection with the sale of TILTON ENGINEERING parts, products or services.

tilton

Tilton Engineering, Inc.

25 Easy Street • P.O. Box 1787

Buellton, CA 93427 U.S.A.

ph +1.805.688.2353 • fax +1.805.688.2745

www.tiltonracing.com

\$5.00 (98-255-20)