



walker

walkerproducts.com

HIGH PERFORMANCE



OE EXACT FIT & PERFORMANCE



QUALITY • COVERAGE • SUPPORT



HIGH PERFORMANCE PRODUCTS • CARBURETION • CARBURETOR REPAIR KITS

High Performance Engine Management & Fuel Components

Carburetor Kits &
Components

Ignition Wires
& Components

Engine
Management
Sensors &
Controls

Tools, Accessories,
Custom Components

Wideband
Oxygen Sensors

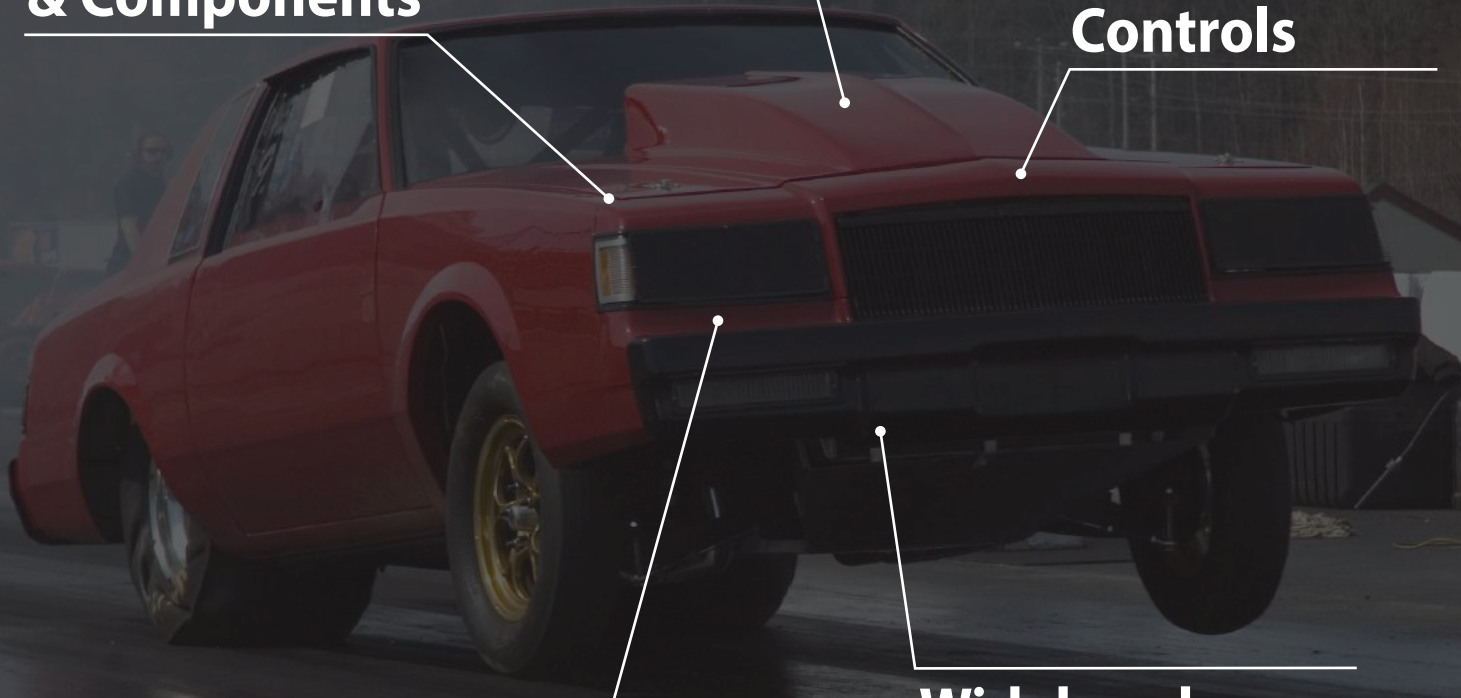

TABLE OF CONTENTS

FUEL INJECTION • OXYGEN SENSORS • BUNGS & PLUGS • ENGINE MANAGEMENT

Oxygen Sensors

Walker 5 Wire Wide Band 5

Bungs & Plugs

Oxygen Sensor/EGTS Bungs & Plugs 6-7

Temperature Sensor Aluminum Bungs 7

Oxygen Sensor Bung & Plug Kits 8

Engine Management

Sensors 9-11

Ignition Wires

Ignition Wires & Mini Crimpers 12

Distributor Caps & Rotors

Distributor Caps & Rotors 13

Fuel Injection Kits

Siemens & Bosch 14

Denso & Delphi 15

Hitachi 16

4-Window Power Valves

4-Window Power Valves 17

Holley® Power Valves & Components 18

Jets

Nitrous, Alcohol, Emulsion & Metering 19

Holley® Jets - Standard Main Jets & Bleeds 20

Holley® Jet Kits 21

Holley®

Accelerator Pumps & Components 22-23

Base Plates 24

Base Plate Components & Throttle Plates 25

Boosters 26

Chokes & Components 27

Choke Conversion Kits 28

Float Bowls 29-30

Float Bowl Components 30-31

Floats & Components 32

Gaskets - Air Cleaner, Air Horn & Fuel Bowl 33

Gaskets - Flange 34

Gaskets - Metering Block 35

Gaskets - Throttle Body 36-37

Main Bodies 38

Metering Blocks & Components 39

Needle & Seat Components 40



TABLE OF CONTENTS CONTINUED

HIGH PERFORMANCE PRODUCTS • CARBURETION • CARBURETOR REPAIR KITS

Holley® (continued)

| | |
|---|----|
| Secondary Diaphragms & Components | 41 |
| Throttle Linkage & Components | 42 |
| Throttle Shafts & Components | 43 |
| Miscellaneous Components | 44 |

Carter™

| | |
|-----------|-------|
| AFB | 45-48 |
|-----------|-------|

Carburetor Repair Kits

| | |
|-----------------|-------|
| Carter™ | 49 |
| Holley® | 50-51 |
| Rochester | 52 |

Connectors

| | |
|--------------|-------|
| 1 Wire | 53 |
| 2 Wire | 53-54 |
| 3 Wire | 54-56 |
| 4 Wire | 56-57 |

Tools & Miscellaneous

| | |
|---|-------|
| Captive Install Tools | 58 |
| EGTS Sockets | 58 |
| Filter Installation Tool | 58 |
| Helicoils | 58-59 |
| Mini Strip & Crimpers | 59 |
| O2 Bung Repair Kits | 59 |
| O2 Chaser | 59 |
| O2 Sensor Sockets | 59 |
| O2 Wrenches | 59 |
| Plain Install Tool | 59 |
| Taps | 59-60 |
| GM Small Block Valve Cover Gasket | 60 |
| Ball Studs | 61 |
| Fuel Inlet Fittings | 61 |
| Throttle Pin | 61 |

Miscellaneous Kits

| | |
|--|----|
| Check Vent Valve & Miscellaneous Kit | 62 |
| Clips, Retainers & Pins | 62 |
| Expansion Plug Kit | 62 |
| Filter & Ball Kit | 62 |

OXYGEN SENSORS

FUEL INJECTION • OXYGEN SENSORS • BUNGS & PLUGS • ENGINE MANAGEMENT



5 WIRE WIDE BAND SENSOR
250-25001
5 WIRE UEGO, 325 mm



5 WIRE WIDE BAND SENSOR
250-25022
5 WIRE LSU 4.2, 725 mm



5 WIRE WIDE BAND SENSOR
250-25033
5 WIRE LSU 4.9, 900 mm







































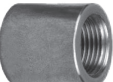

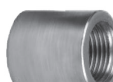
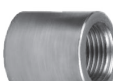









5 WIRE WIDE BAND SENSOR
250-25075
WIRE LSU 4.9, 325 mm



5 WIRE WIDE BAND SENSOR
250-25076
5 WIRE LSU 4.2, 515 mm

HIGH PERFORMANCE PRODUCTS • CARBURETION • CARBURETOR REPAIR KITS

| | | | | | | |
|--|--|--|--|---|---|---|
|  <p>90-164 1215 MILD STEEL THREADS: M18 x 1.5-6E 1.0" OD x 0.400" THICK</p> |  <p>90-164P 5 PACK 1215 MILD STEEL THREADS: M18 x 1.5-6E 1.0" OD x 0.400" THICK</p> |  <p>90-164SS 303 STAINLESS STEEL THREADS: M18 x 1.5-6E 1.0" OD x 0.400" THICK</p> |  <p>90-164SS-C 303 STAINLESS STEEL WITH CURVE THREADS: M18 x 1.5-6E 1.0" OD x 0.400" THICK</p> |  <p>90-184 1215 MILD STEEL STEPPED THREADS: M18 x 1.5-6E 1.0" OD x 0.875" STEP x 0.530" THICK</p> |  <p>90-184SS 303 STAINLESS STEEL STEPPED THREADS: M18 x 1.5-6E 1.0" OD x 0.875" STEP x 0.530" THICK</p> |  <p>90-184P 5 PACK 1215 MILD STEEL STEPPED THREADS: M18 x 1.5-6E 1.0" OD x 0.875" STEP x 0.530" THICK</p> |
|  <p>90-185 1215 MILD STEEL THREADS: M18 x 1.5-6E 1.0" Hex, 0.650" Thick Use with 1401F Copper Washer</p> |  <p>90-185P 5 PACK 1215 MILD STEEL THREADS: M18 x 1.5-6E 1.0" Hex, 0.650" Thick Use with 1401F Copper Washer</p> |  <p>90-185SS 303 STAINLESS STEEL THREADS: M18 x 1.5-6E 1.0" Hex, 0.650" Thick Use with 1401F Copper Washer</p> |  <p>90-185SSP 5 PACK 303 STAINLESS STEEL THREADS: M18 x 1.5-6E 1.0" Hex, 0.650" Thick Use with 1401F Copper Washer</p> |  <p>90-186 1215 MILD STEEL STEPPED THREADS: M10 x 1.25-6H 1.0" OD x 0.735" STEP x 0.315" THICK</p> |  <p>90-186P 5 PACK 1215 MILD STEEL STEPPED THREADS: M10 x 1.25-6H 1.0" OD x 0.735" STEP x 0.315" THICK</p> |  <p>90-186SS 303 STAINLESS STEEL STEPPED THREADS: M10 x 1.25-6H 1.0" OD x 0.735" STEP x 0.315" THICK</p> |
|  <p>90-186SSP 5 PACK 303 STAINLESS STEEL STEPPED THREADS: M10 x 1.25-6H 1.0" OD x 0.735" STEP x 0.315" THICK</p> |  <p>90-187 1215 MILD STEEL STEPPED THREADS: M12 x 1.25-6E 1.0" OD x 0.740" STEP x 0.315" THICK</p> |  <p>90-187P 5 PACK 1215 MILD STEEL STEPPED THREADS: M12 x 1.25-6E 1.0" OD x 0.740" STEP x 0.315" THICK</p> |  <p>90-187SS 303 STAINLESS STEEL STEPPED THREADS: M12 x 1.25-6E 1.0" OD x 0.740" STEP x 0.315" THICK</p> |  <p>90-187SSP 5 PACK 303 STAINLESS STEEL STEPPED THREADS: M12 x 1.25-6E 1.0" OD x 0.740" STEP x 0.315" THICK</p> |  <p>90-189 1215 MILD STEEL THREADS: M12 x 1.25-6H 1.0" OD x 0.500" THICK</p> |  <p>90-189P 5 PACK 1215 MILD STEEL THREADS: M12 x 1.25-6H 1.0" OD x 0.500" THICK</p> |
|  <p>90-189SS 303 STAINLESS STEEL THREADS: M12 x 1.25-6H 1.0" OD x 0.500" THICK</p> |  <p>90-189SSP 5 PACK 303 STAINLESS STEEL THREADS: M12 x 1.25-6H 1.0" OD x 0.500" THICK</p> |  <p>90-190 1215 MILD STEEL 62° ANGLE THREADS: M18 x 1.5-6H 1.0" OD x 0.975" THICK</p> |  <p>90-190P 5 PACK 1215 MILD STEEL 62° ANGLE THREADS: M18 x 1.5-6H 1.0" OD x 0.975" THICK</p> |  <p>90-190SS 303 STAINLESS STEEL 62° ANGLE THREADS: M18 x 1.5-6H 1.0" OD x 0.975" THICK</p> |  <p>90-190SSP 5 PACK 303 STAINLESS STEEL 62° ANGLE THREADS: M18 x 1.5-6H 1.0" OD x 0.975" THICK</p> |  <p>90-191 1215 MILD STEEL THREADS: 1/2-28UNEF</p> |
|  <p>90-195 FOR OFF-ROAD RACING ONLY 1215 MILD STEEL THREADS: M18 x 1.5-6H 1.0" OD x 1.0" THICK</p> |  <p>90-195P 5 PACK FOR OFF-ROAD RACING ONLY 1215 MILD STEEL THREADS: M18 x 1.5-6H 1.0" OD x 1.0" THICK</p> |  <p>90-195SS 303 STAINLESS STEEL THREADS: M18 x 1.5-6H 1.0" OD x 1.0" THICK</p> |  <p>90-195SSP 5 PACK 303 STAINLESS STEEL THREADS: M18 x 1.5-6H 1.0" OD x 1.0" THICK</p> |  <p>90-195SS-C 303 STAINLESS STEEL WITH CURVE THREADS: M18 x 1.5-6H 1.0" OD x 1.0" THICK</p> |  <p>90-199 1215 MILD STEEL THREADS: M18 x 1.5-6H 1.0" OD x 0.500" THICK</p> |  <p>90-199P 5 PACK 1215 MILD STEEL THREADS: M18 x 1.5-6H 1.0" OD x 0.500" THICK</p> |
|  <p>90-199SS 303 STAINLESS STEEL THREADS: M18 x 1.5-6H 1.0" OD x 0.500" THICK</p> |  <p>90-199SSP 5 PACK 303 STAINLESS STEEL THREADS: M18 x 1.5-6H 1.0" OD x 0.500" THICK</p> |  <p>90-200 INTERNAL 8MM HEX 1215 MILD STEEL THREADS: M18 x 1.5-6E .875" OD x 0.510" THICK</p> |  <p>90-200P 5 PACK INTERNAL 8MM HEX 1215 MILD STEEL THREADS: M18 x 1.5-6E .875" OD x 0.510" THICK</p> |  <p>90-200SS INTERNAL 8MM HEX 303 STAINLESS STEEL THREADS: M18 x 1.5-6E .875" OD x 0.510" THICK</p> |  <p>90-200SSP 5 PACK INTERNAL 8MM HEX 303 STAINLESS STEEL THREADS: M18 x 1.5-6E .875" OD x 0.510" THICK</p> |  <p>90-203 INTERNAL 6MM HEX 1215 MILD STEEL THREADS: M12 x 1.25-6E .625" OD x 0.400" THICK</p> |
|  <p>90-203SS INTERNAL 6MM HEX 303 STAINLESS STEEL THREADS: M12 x 1.25-6E .625" OD x 0.400" THICK</p> |  <p>90-203SSP 5 PACK INTERNAL 6MM HEX 303 STAINLESS STEEL THREADS: M12 x 1.25-6E .625" OD x 0.400" THICK</p> |  <p>90-204 1215 MILD STEEL THREADS: M12 x 1.25-6E 0.625" Hex, 0.570" Thick Use with 1401F Copper Washer</p> |  <p>90-204P 5 PACK 1215 MILD STEEL THREADS: M12 x 1.25-6E 0.625" Hex, 0.570" Thick Use with 1401F Copper Washer</p> |  <p>90-204SS 303 STAINLESS STEEL THREADS: M12 x 1.25-6E 0.625" Hex, 0.570" Thick Use with 1401F Copper Washer</p> |  <p>90-204SSP 5 PACK 303 STAINLESS STEEL THREADS: M12 x 1.25-6E 0.625" Hex, 0.570" Thick Use with 1401F Copper Washer</p> |  <p>90-206SS 303 STAINLESS STEEL 62° ANGLE THREADS: M18 x 1.5-6H 1.0" OD x 0.824" THICK</p> |

O2/EGTS SENSOR BUNGS & PLUGS

FUEL INJECTION • OXYGEN SENSORS • BUNGS & PLUGS • ENGINE MANAGEMENT

| | | | | | | |
|---|--|---|---|--|---|---|
|  <p>90-206SS-C 303 STAINLESS STEEL 62° ANGLE & CURVE THREADS: M18 x 1.5-6H 1.0" OD x 0.824" THICK</p> |  <p>90-207SS 303 STAINLESS STEEL THREADS: M18 x 1.5-6H 1.0" OD x 0.55" THICK</p> |  <p>90-207SS-C 303 STAINLESS STEEL WITH CURVE THREADS: M18 x 1.5-6H 1.0" OD x 0.55" THICK</p> |  <p>90-210 1215 MILD STEEL ID THREADS: M12 x 1.25-6E OD THREADS: M18 x 1.5-6E 0.875" Hex, 0.510" Thick Use with 1401F Copper Washer</p> |  <p>90-210SS 303 STAINLESS STEEL ID THREADS: M12 x 1.25-6E OD THREADS: M18 x 1.5-6E 0.875" Hex, 0.510" Thick Use with 1401F Copper Washer</p> |  <p>90-211 1215 MILD STEEL STEPPED OD THREADS: M18 x 1.5-6E 0.875" x 0.510" Thick</p> |  <p>90-212 1215 MILD STEEL, ZINC PLATED ID THREADS: 1/8-27NPT OD THREADS: M18 x 1.5-6E 1" Hex, 0.65" Thick Use with 1401F Copper Washer</p> |
|  <p>90-213-C 1215 MILD STEEL WITH CURVE THREADS: M18 x 1.5-6H 1.0" OD x 0.824" THICK</p> |  <p>90-214SS 303 STAINLESS STEEL THREADS: 1/8-27NPT 0.500" OD x 0.500" THICK</p> |  <p>91-100 14mm EGTS BUNG 303 STAINLESS STEEL THREADS: M14 x 1.5-6H</p> |  <p>91-101 14mm EGTS BUNG 303 STAINLESS STEEL THREADS: M14 x 1.5-6H</p> |  <p>91-102 14mm EXTERNAL EGTS BUNG 303 STAINLESS STEEL THREADS: M14 x 1.5-6H</p> |  <p>91-103 14mm EGTS BUNG 303 STAINLESS STEEL THREADS: M14 x 1.5-6H</p> |  <p>91-104 14mm EGTS PLUG 303 STAINLESS STEEL THREADS: M14 x 1.5-6H</p> |
|  <p>91-105 14mm EGTS CAP 303 STAINLESS STEEL THREADS: M14 x 1.5-6H</p> |  <p>91-106 12mm EGTS BUNG 303 STAINLESS STEEL THREADS: M12 x 1.5-6H</p> |  <p>91-107 14mm EGTS BUNG 303 STAINLESS STEEL THREADS: M14 x 1.5-6H</p> |  <p>91-108 12mm EGTS BUNG 303 STAINLESS STEEL THREADS: M12 x 1.5-6H</p> |  <p>91-109 12mm EGTS BUNG 303 STAINLESS STEEL THREADS: M12 x 1.5-6H</p> |  <p>91-110 12mm EGTS BUNG 303 STAINLESS STEEL THREADS: M12 x 1.5-6H</p> |  <p>91-111 16mm EGTS BUNG 303 STAINLESS STEEL THREADS: M16 x 1.5-6H</p> |
|  <p>91-112 16mm EGTS CAP 303 STAINLESS STEEL THREADS: M16 x 1.5-6H</p> |  <p>91-113 14mm EGTS BUNG 303 STAINLESS STEEL THREADS: M14 x 1.5-6H</p> |  <p>91-114 20mm EGTS BUNG 303 STAINLESS STEEL THREADS: M20 x 1.5-6H</p> |  <p>91-115 14mm EGTS BUNG 303 STAINLESS STEEL THREADS: M14 x 1.5-6H</p> |  <p>91-116 12mm EGTS BUNG 303 STAINLESS STEEL THREADS: M12 x 1.25-6H</p> |  <p>91-117 14mm EGTS BUNG 303 STAINLESS STEEL THREADS: M14 x 1.5-6H</p> |  <p>91-118 12mm EGTS BUNG 303 STAINLESS STEEL THREADS: M12 x 1.5-6H</p> |
|  <p>91-119 12mm EGTS CAP 303 STAINLESS STEEL THREADS: M12 x 1.25-6H</p> |  <p>91-120 16mm EGTS BUNG 303 STAINLESS STEEL THREADS: M16 x 1.5-6H</p> |  <p>91-121 12mm EGTS BUNG 303 STAINLESS STEEL THREADS: M12 x 1.25-6H</p> |  <p>91-122 12mm EGTS BUNG 303 STAINLESS STEEL THREADS: M12 x 1.25-6H</p> |  <p>91-123 14mm EGTS BUNG 303 STAINLESS STEEL THREADS: M14 x 1.5-6H</p> |  <p>91-124 12mm EGTS BUNG 303 STAINLESS STEEL THREADS: M12 x 1.25-6H</p> |  <p>91-125 14mm EGTS BUNG 303 STAINLESS STEEL THREADS: M14 x 1.5-6H</p> |

TEMPERATURE SENSOR BUNGS



91-301
3/8 NPT
6061 ALUMINUM



91-302
1/8 NPT
6061 ALUMINUM

QUALITY • COVERAGE • SUPPORT





O2 SENSOR BUNG & PLUG KITS

HIGH PERFORMANCE PRODUCTS • CARBURETION • CARBURETOR REPAIR KITS

Available in both Mild Steel & Stainless Steel

PERFECT FOR HIGH PERFORMANCE, CUSTOM & REPAIR JOBS!

Walker's bung kits feature 6 popular bungs and include plugs, gaskets and flanges. These handy kits will save busy technician's time and increase profits.

Bungs & Plugs also available in bulk quantities!

Custom Bung & Plug Kits available!



Steel Bungs, Plugs and Flanges WPA-105

Stainless Steel Bungs, Plugs and Flanges WPA-105SS



What is included:

| WPA-105 | | | WPA-105SS | | | WPA106 | | |
|---------|-----|---------------------------|------------|-----|--|--------|-----|---------------------------|
| PART # | QTY | DESCRIPTION | PART # | QTY | DESCRIPTION | PART # | QTY | DESCRIPTION |
| 165-197 | 2 | GASKET, 44-54mm FLANGE | 90-195 | 5 | STEEL BUNG 18mm (1") | 90-187 | 5 | STEEL BUNG 12mm (STEPPED) |
| 165-202 | 2 | GASKET, 38-44mm FLANGE | 165-197 | 2 | GASKET, 44-54mm FLANGE | 90-190 | 5 | STEEL BUNG 18mm (ANGLED) |
| 85-417 | 2 | FLANGE, 38-44 mm | 165-202 | 2 | GASKET, 38-44mm FLANGE | 90-195 | 5 | STEEL BUNG 18mm (1") |
| 85-418 | 2 | FLANGE, 44-54mm | 85-417 | 2 | FLANGE, 38-44 mm | | | |
| 90-164 | 5 | STEEL BUNG 18mm | 85-418 | 2 | FLANGE, 44-54mm | | | |
| 90-184 | 5 | STEEL BUNG 18mm (STEPPED) | 90-164SS | 5 | STAINLESS STEEL BUNG 18mm | | | |
| 90-185 | 5 | STEEL BUNG 18mm (PLUG) | 90-184SS | 5 | STAINLESS STEEL BUNG 18mm (STEPPED) | | | |
| 90-186 | 5 | STEEL BUNG 10mm (STEPPED) | 90-185SS | 5 | STAINLESS STEEL BUNG 18mm (PLUG) | | | |
| 90-187 | 5 | STEEL BUNG 12mm (STEPPED) | 90-186SS | 5 | STAINLESS STEEL BUNG 10mm (STEPPED) | | | |
| 90-190 | 5 | STEEL BUNG 18mm (ANGLED) | 90-187SS | 5 | STAINLESS STEEL BUNG 12mm (STEPPED) | | | |
| | | | 90-190SS | 5 | STAINLESS STEEL BUNG 18mm (ANGLED) | | | |
| | | | 90-195SS-C | 5 | STAINLESS STEEL BUNG 18mm (1") W/CURVE | | | |

WALKER PRODUCTS • 525 WEST CONGRESS STREET • PACIFIC, MO 63069 • www.walkerproducts.com
 U.S. Corporate Office: 636-257-2400 • Fax: 636-257-6211 • Customer Service: 636-257-1700 • Technical Support: 844-252-0114
 U.K. Sales Office and Distribution Center: +44-121-459-8006 • sales europe@walkerproducts.com
 Oficinas para Mexico: +52-72-2402-2167 • Soporte tecnico y servicio al cliente en Mexico: +52-72-2207-8957

ENGINE MANAGEMENT

FUEL INJECTION • OXYGEN SENSORS • BUNGS & PLUGS • ENGINE MANAGEMENT



INTAKE AIR SENSOR - LS SERIES
210-1001



COOLANT TEMPERATURE SENSOR
211-1012



IDLE AIR CONTROL MOTOR
215-1003



IDLE AIR CONTROL MOTOR - LS SERIES
215-1064



CRANKSHAFT SENSOR - LS SERIES
235-1057



CAMSHAFT SENSOR REAR - LS SERIES
235-1156



CAMSHAFT SENSOR REAR FSK - LS SERIES
235-91156



FLEX FUEL SENSOR
243-1003



FLEX FUEL SENSOR
243-1004

QUALITY • COVERAGE • SUPPORT





KNOCK SENSOR - LS SERIES
242-1039



KNOCK SENSOR - LS SERIES
242-1049



KNOCK SENSOR REPAIR KIT - LS SERIES
242-91039-2



MAP SENSOR ASSEMBLY 1 BAR
225-1001



MAP SENSOR ASSEMBLY 2 BAR
225-1008



MAP SENSOR ASSEMBLY 3 BAR
225-1026



MAP SENSOR ASSEMBLY 4 BAR
225-1039



MAP SENSOR BAR 1 - LS SERIES
225-1024



MAP SENSOR BAR 2 - LS SERIES
225-1100

ENGINE MANAGEMENT

FUEL INJECTION • OXYGEN SENSORS • BUNGS & PLUGS • ENGINE MANAGEMENT



MAP SENSOR BAR 3 - LS SERIES
225-1258



MASS AIR FLOW SENSOR
245-1017



MASS AIR FLOW SENSOR
245-1062



MASS AIR FLOW ASSEMBLY - LS SERIES
245-1107



MASS AIR FLOW SENSOR ONLY - LS SERIES
245-1103



THROTTLE POSITION SENSOR
200-1043



THROTTLE POSITION SENSOR - LS SERIES
200-1053



THROTTLE POSITION SENSOR - LS SERIES
200-1356



THROTTLE POSITION SENSOR FSK - LS SERIES
200-91053

QUALITY • COVERAGE • SUPPORT





LS WHITE CERAMIC BOOT SET
924-6008



LS BLACK CERAMIC BOOT SET
924-6009B

- Ceramic boots withstand temperatures up to 2000° F
- Silicone jacketed wire is rated at 600° F



UNIVERSAL SILICONE
90 DEGREE BOOT SET
924-6013



7.0 - 8.0 MINI STRIPPER CRIMPER
924-5001



8.5 - 9.5 MINI STRIPPER CRIMPER
924-5002



7.0-8.0 & 8.5-9.5
MINI STRIPPER CRIMPERS
924-5003

| WALKER # | DESCRIPTION | WIRE | RESISTANCE | WALKER # | DESCRIPTION | WIRE | RESISTANCE |
|-----------|---|-------|------------|-----------|--|-------|------------|
| 924-6001 | LS Series - Silicone Straight Boot Short - 10" | 8.8MM | 500 Ω/FT | 924-6015 | Universal Silicone Straight Boot | 8.8MM | 500 Ω/FT |
| 924-6002 | LS Series - Silicone 90 Degree Short - 10" | 8.8MM | 500 Ω/FT | 924-6016 | Universal Ceramic 90 Degree Boot, White | 8.8MM | 500 Ω/FT |
| 924-6003 | LS Series - Silicone 135 Degree Short - 10" | 8.8MM | 500 Ω/FT | 924-6016B | Universal Ceramic 90 Degree Boot, Black | 8.8MM | 500 Ω/FT |
| 924-6004 | LS Series - Silicone Straight Long - 13" | 8.8MM | 500 Ω/FT | 924-6017 | Universal Ceramic 135 Degree Boot, White | 8.8MM | 500 Ω/FT |
| 924-6005 | LS Series - Silicone 90 Degree Long - 13" | 8.8MM | 500 Ω/FT | 924-6017B | Universal Ceramic 135 Degree Boot, Black | 8.8MM | 500 Ω/FT |
| 924-6006 | LS Series - Silicone 135 Degree Long - 13" | 8.8MM | 500 Ω/FT | 924-6018 | Universal Ceramic Straight Boot, White | 8.8MM | 500 Ω/FT |
| 924-6007 | LS Series - Ceramic Straight Short, White - 10" | 8.8MM | 500 Ω/FT | 924-6018B | Universal Ceramic Straight Boot, Black | 8.8MM | 500 Ω/FT |
| 924-6007B | LS Series - Ceramic Straight Short, Black - 10" | 8.8MM | 500 Ω/FT | 924-6019 | Small Block Chevy Points | 8.8MM | 500 Ω/FT |
| 924-6008 | LS Series - Ceramic 90 Degree Short, White - 10" | 8.8MM | 500 Ω/FT | 924-6020 | Small Block Chevy HEI | 8.8MM | 500 Ω/FT |
| 924-6008B | LS Series - Ceramic 90 Degree Short, Black - 10" | 8.8MM | 500 Ω/FT | 924-6021 | Big Block Chevy Points | 8.8MM | 500 Ω/FT |
| 924-6009 | LS Series - Ceramic 135 Degree Short, White - 10" | 8.8MM | 500 Ω/FT | 924-6022 | Big Block Chevy HEI | 8.8MM | 500 Ω/FT |
| 924-6009B | LS Series - Ceramic 135 Degree Short, Black - 10" | 8.8MM | 500 Ω/FT | 924-6023 | Small Block Ford Points | 8.8MM | 500 Ω/FT |
| 924-6010 | LS Series - Ceramic Straight Long, White - 13" | 8.8MM | 500 Ω/FT | 924-6024 | Small Block Ford HEI | 8.8MM | 500 Ω/FT |
| 924-6010B | LS Series - Ceramic Straight Long, Black - 13" | 8.8MM | 500 Ω/FT | 924-6025 | Big Block Ford Points | 8.8MM | 500 Ω/FT |
| 924-6011 | LS Series - Ceramic 90 Degree Long, White - 13" | 8.8MM | 500 Ω/FT | 924-6026 | Big Block Ford HEI | 8.8MM | 500 Ω/FT |
| 924-6011B | LS Series - Ceramic 90 Degree Long, Black - 13" | 8.8MM | 500 Ω/FT | 924-6027 | Mopar Small Block | 8.8MM | 500 Ω/FT |
| 924-6012 | LS Series - Ceramic 135 Degree Long, White - 13" | 8.8MM | 500 Ω/FT | 924-6028 | Mopar Big Block | 8.8MM | 500 Ω/FT |
| 924-6012B | LS Series - Ceramic 135 Degree Long, Black - 13" | 8.8MM | 500 Ω/FT | 924-6029 | Mopar Hemi 426 Early | 8.8MM | 500 Ω/FT |
| 924-6013 | Universal Silicone 90 Degree Boot | 8.8MM | 500 Ω/FT | 924-6030 | Mopar Hemi Late Model | 8.8MM | 500 Ω/FT |
| 924-6014 | Universal Silicone 135 Degree Boot | 8.8MM | 500 Ω/FT | | | | |

CUSTOM COLORS & SETS AVAILABLE

DISTRIBUTOR CAPS & ROTORS

FUEL INJECTION • OXYGEN SENSORS • BUNGS & PLUGS • ENGINE MANAGEMENT



DISTRIBUTOR CAP
925-1019
FORD HEI STYLE V8



DISTRIBUTOR CAP
925-1014
FORD POINTS STYLE V8



DISTRIBUTOR CAP
925-1083
GM EARLY POINT STYLE V8



DISTRIBUTOR CAP
925-1005
GM HEI STYLE V8



DISTRIBUTOR CAP
925-1012
GM POINTS STYLE V8



DISTRIBUTOR CAP
925-1013
GM VORTEC STYLE V8



DISTRIBUTOR ROTOR
926-1019
FORD HEI STYLE V8



DISTRIBUTOR ROTOR
926-1015
FORD POINTS STYLE V8



DISTRIBUTOR ROTOR
926-1021
FORD POINTS STYLE V8



DISTRIBUTOR ROTOR
926-1006
GM HEI STYLE V8



DISTRIBUTOR ROTOR
926-1014
GM HEI STYLE V8



DISTRIBUTOR ROTOR
926-1012
GM LATE MODEL POINTS STYLE V8



DISTRIBUTOR ROTOR
926-1001
MOPAR V8



DISTRIBUTOR ROTOR
926-1004
MOPAR V8 MAGNUM

QUALITY • COVERAGE • SUPPORT



SIEMENS FUEL INJECTION BULK REPAIR KITS



BOSCH FUEL INJECTION BULK REPAIR KITS



| PART# | DESCRIPTION | QUANTITY | |
|--------|----------------------------------|----------|--------|
| | | WPA107 | WPA112 |
| 1199F | UPPER INJECTOR O-RING | 50 | 20 |
| 30-103 | FUEL INJECTOR FILTER - LUCAS | 50 | 20 |
| 30-117 | FUEL INJECTOR FILTER | 50 | 20 |
| 30-131 | FUEL INJECTOR FILTER | 50 | 20 |
| 30-88 | FUEL INJECTOR FILTER | 50 | 25 |
| 92-110 | FUEL INJECTION O-RING | 100 | 50 |
| 95-104 | BOSCH MULTI-PORT 6.6MM PINTLE | 50 | 20 |
| 95-105 | WEBER MULTI-PORT PINTLE CAP-GRAY | 50 | 20 |
| 95-158 | PINTLE CAP BOSCH | 50 | 20 |
| G1422 | INJECTOR O-RING, BROWN VITON | 100 | 50 |
| G1434 | FUEL INJECTOR SPACER | 50 | 50 |
| G1440 | INJECTOR O-RING - BUNA | 100 | 50 |
| 840 | FILTER INSERT & REMOVAL TOOL | 1 | 1 |

| PART# | DESCRIPTION | QUANTITY | |
|--------|------------------------------|----------|--------|
| | | WPA108 | WPA113 |
| 30-117 | FUEL INJECTOR FILTER | 50 | 20 |
| 30-88 | FUEL INJECTOR FILTER | 50 | 50 |
| 85-348 | FUEL INJECTOR PINTLE CAP | 50 | 50 |
| 85-354 | PLASTIC PINTLE CAP | 50 | 20 |
| 85-368 | INJECTOR CLAMP | 50 | 20 |
| 95-157 | PINTLE CAP | 50 | 20 |
| 95-158 | PINTLE CAP BOSCH | 50 | 20 |
| 95-159 | PINTLE CAP | 50 | 20 |
| 95-169 | NYLON INJECTOR SPACER | 50 | 20 |
| 95-170 | FUEL INJECTOR SEAL | 50 | 20 |
| 95-190 | FORD SMALL HOLE PINTLE CAP | 50 | 20 |
| G1440 | INJECTOR O-RING - BUNA | 100 | 50 |
| 840 | FILTER INSERT & REMOVAL TOOL | 1 | 1 |

FUEL INJECTION KITS DENSO & DELPHI

FUEL INJECTION • OXYGEN SENSORS • BUNGS & PLUGS • ENGINE MANAGEMENT

DENSO FUEL INJECTION BULK REPAIR KITS



| PART# | DESCRIPTION | QUANTITY | |
|--------|------------------------------|----------|--------|
| | | WPA109 | WPA114 |
| 1199F | UPPER INJECTOR O-RING | 50 | 20 |
| 1333F | FUEL INJECTION VITON O-RING | 50 | 20 |
| 1334F | FUEL INJECTION VITON O-RING | 100 | 20 |
| 1399F | INJECTOR SEAL - VITON | 50 | 10 |
| 30-103 | FUEL INJECTOR FILTER - LUCAS | 50 | 10 |
| 30-117 | FUEL INJECTOR FILTER | 50 | 10 |
| 85-353 | PLASTIC PINTLE CAP | 50 | 20 |
| 92-108 | FUEL INJECTION O-RING | 50 | 10 |
| 92-110 | FUEL INJECTION O-RING | 50 | 20 |
| 92-131 | FUEL INJECTION O-RING | 50 | 20 |
| 93-117 | FUEL INJECTION GROMMET | 50 | 10 |
| 95-145 | CANARY 2-HOLE CAP | 50 | 10 |
| 95-186 | GM FLEX FUEL PINTLE CAP | 50 | 10 |
| G1422 | INJECTOR O-RING, BROWN VITON | 100 | 50 |
| 840 | FILTER INSERT & REMOVAL TOOL | 1 | 1 |

DELPHI FUEL INJECTION BULK REPAIR KITS



| PART# | DESCRIPTION | QUANTITY | |
|--------|------------------------------|----------|--------|
| | | WPA110 | WPA115 |
| 1279F | AIRBLEED SOCKET O-RING | 50 | 20 |
| 30-129 | FUEL INJECTOR FILTER | 50 | 10 |
| 30-88 | FUEL INJECTOR FILTER | 50 | 50 |
| 30-92 | FUEL INJECTOR FILTER | 50 | 20 |
| 92-110 | FUEL INJECTION O-RING | 50 | 20 |
| 92-131 | FUEL INJECTION O-RING | 50 | 20 |
| 92-137 | FUEL INJECTION O-RING | 50 | 20 |
| 92-142 | O-RING | 50 | 20 |
| 95-126 | FUEL INJECTOR END CAP 9/16 | 50 | 20 |
| 95-158 | PINTLE CAP BOSCH | 50 | 20 |
| 95-196 | LATE VORTEC SPIDER CLIPS | 50 | 20 |
| G1435 | INJECTOR O-RING | 50 | 50 |
| G1440 | INJECTOR O-RING - BUNA | 100 | 50 |
| 840 | FILTER INSERT & REMOVAL TOOL | 1 | 1 |

QUALITY • COVERAGE • SUPPORT





| PART# | DESCRIPTION | QUANTITY | |
|--------|------------------------------|----------|--------|
| | | WPA111 | WPA116 |
| 30-127 | M/P NISSAN PATHFINDER 6 CYL. | 50 | 20 |
| 30-105 | FILTER | 50 | 20 |
| 30-117 | FUEL INJECTOR FILTER | 50 | 20 |
| 95-151 | PINTLE CAP | 50 | 20 |
| 92-106 | FUEL INJECTION O-RING | 50 | 20 |
| 92-119 | FUEL INJECTION O-RING | 50 | 20 |
| 92-107 | FUEL INJECTION O-RING | 50 | 20 |
| 840 | FILTER INSERT & REMOVAL TOOL | 1 | 1 |



**ALL FUEL INJECTION KITS INCLUDE
#840 FILTER INSTALLATION
AND REMOVAL TOOL**

4-WINDOW POWER VALVES

FUEL INJECTION • OXYGEN SENSORS • BUNGS & PLUGS • ENGINE MANAGEMENT

NEW 4-Window Power Valves

- All valve flow surfaces have been radiused to reduce turbulence and maximize fuel flow
- New valve stem design provides a more aggressive response
- Improvements over competitive designs increased the working area of the diaphragm provide a quicker response
- Supports channel restriction diameters up to 0.140"
- 100% tested and calibrated in Walker's USA factory for maximum performance



| WALKER # | OPENING VACUUM |
|----------|----------------|
| 70-525 | 2.5" |
| 70-535 | 3.5" |
| 70-545 | 4.5" |
| 70-555 | 5.5" |
| 70-565 | 6.5" |
| 70-575 | 7.5" |
| 70-585 | 8.5" |
| 70-595 | 9.5" |
| 70-505 | 10.5" |



STANDARD FLOW POWER VALVES



| WALKER # | H # | OPENING VACUUM |
|----------|---------|----------------|
| 70-105 | 125-105 | 10.5" |
| 70-125 | 125-25 | 2.5" |
| 70-135 | 125-35 | 3.5" |
| 70-145 | 125-45 | 4.5" |
| 70-150 | 125-50 | 5.0" |
| 70-155 | 125-55 | 5.5" |
| 70-165 | 125-65 | 6.5" |
| 70-175 | 125-75 | 7.5" |
| 70-185 | 125-85 | 8.5" |
| 70-195 | 125-95 | 9.5" |

| ALCOHOL | | OPENING VACUUM |
|----------|---------|----------------|
| WALKER # | H # | |
| 70-287 | 125-145 | 4.5" |
| 70-288 | 125-165 | 6.5" |

HI-FLOW POWER VALVES



| WALKER # | H # | OPENING VACUUM |
|----------|----------|----------------|
| 70-205 | 125-1005 | 10.5" |
| 70-225 | 125-125 | 2.5" |
| 70-235 | 125-135 | 3.5" |
| 70-245 | 125-145 | 4.5" |
| 70-255 | 125-155 | 5.5" |
| 70-265 | 125-165 | 6.5" |
| 70-285 | 125-185 | 8.5" |



CHECK BALL
90-146



POWER VALVE CHECK BALL SCREW
80-222



POWER VALVE CHECK BALL SEAT
85-477



POWER VALVE CHECK BALL SPRING
66-147

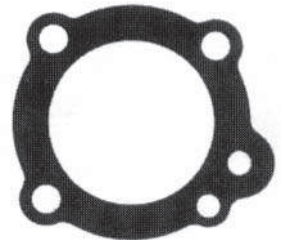

POWER VALVE COVER GASKET
G1623

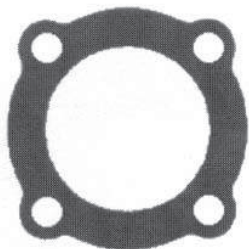

POWER VALVE COVER GASKET
G1624



POWER VALVE GASKET
G1220



POWER VALVE GASKET
G911



POWER VALVE PLUG
70-69
H #26-36

NITROUS - JETS



| Walker Number | Orifice Size | Walker Number | Orifice Size | Walker Number | Orifice Size | Walker Number | Orifice Size | Walker Number | Orifice Size | Walker Number | Orifice Size |
|---------------|--------------|---------------|--------------|---------------|--------------|---------------|--------------|---------------|--------------|---------------|--------------|
| 120-50-014 | .014" | 120-50-032 | .032" | 120-50-050 | .050" | 120-50-068 | .068" | 120-50-086 | .086" | 120-50-104 | .104" |
| 120-50-015 | .015" | 120-50-033 | .033" | 120-50-051 | .051" | 120-50-069 | .069" | 120-50-087 | .087" | 120-50-105 | .105" |
| 120-50-016 | .016" | 120-50-034 | .034" | 120-50-052 | .052" | 120-50-070 | .070" | 120-50-088 | .088" | 120-50-106 | .106" |
| 120-50-017 | .017" | 120-50-035 | .035" | 120-50-053 | .053" | 120-50-071 | .071" | 120-50-089 | .089" | 120-50-107 | .107" |
| 120-50-018 | .018" | 120-50-036 | .036" | 120-50-054 | .054" | 120-50-072 | .072" | 120-50-090 | .090" | 120-50-108 | .108" |
| 120-50-019 | .019" | 120-50-037 | .037" | 120-50-055 | .055" | 120-50-073 | .073" | 120-50-091 | .091" | 120-50-109 | .109" |
| 120-50-020 | .020" | 120-50-038 | .038" | 120-50-056 | .056" | 120-50-074 | .074" | 120-50-092 | .092" | 120-50-110 | .110" |
| 120-50-021 | .021" | 120-50-039 | .039" | 120-50-057 | .057" | 120-50-075 | .075" | 120-50-093 | .093" | 120-50-111 | .111" |
| 120-50-022 | .022" | 120-50-040 | .040" | 120-50-058 | .058" | 120-50-076 | .076" | 120-50-094 | .094" | 120-50-112 | .112" |
| 120-50-023 | .023" | 120-50-041 | .041" | 120-50-059 | .059" | 120-50-077 | .077" | 120-50-095 | .095" | 120-50-113 | .113" |
| 120-50-024 | .024" | 120-50-042 | .042" | 120-50-060 | .060" | 120-50-078 | .078" | 120-50-096 | .096" | 120-50-114 | .114" |
| 120-50-025 | .025" | 120-50-043 | .043" | 120-50-061 | .061" | 120-50-079 | .079" | 120-50-097 | .097" | 120-50-115 | .115" |
| 120-50-026 | .026" | 120-50-044 | .044" | 120-50-062 | .062" | 120-50-080 | .080" | 120-50-098 | .098" | 120-50-116 | .116" |
| 120-50-027 | .027" | 120-50-045 | .045" | 120-50-063 | .063" | 120-50-081 | .081" | 120-50-099 | .099" | 120-50-117 | .117" |
| 120-50-028 | .028" | 120-50-046 | .046" | 120-50-064 | .064" | 120-50-082 | .082" | 120-50-100 | .100" | 120-50-118 | .118" |
| 120-50-029 | .029" | 120-50-047 | .047" | 120-50-065 | .065" | 120-50-083 | .083" | 120-50-101 | .101" | 120-50-119 | .119" |
| 120-50-030 | .030" | 120-50-048 | .048" | 120-50-066 | .066" | 120-50-084 | .084" | 120-50-102 | .102" | 120-50-120 | .120" |
| 120-50-031 | .031" | 120-50-049 | .049" | 120-50-067 | .067" | 120-50-085 | .085" | 120-50-103 | .103" | | |

BRASS NITROUS - JETS

EMULSION - JETS

| Walker Number | Orifice Size | |
|---------------|--------------|-------------------------------------|
| 120-60-00 | .014" | Pilot Hole - Drill to Required Size |



| Walker Number | |
|---------------|-------------------|
| 120-80 | (Specify Orifice) |



ALCOHOL - JETS



| Walker # | Orifice | Walker # | Orifice | Walker # | Orifice | Walker # | Orifice | Walker # | Orifice | Walker # | Orifice |
|----------|---------|----------|---------|----------|---------|----------|---------|----------|---------|----------|---------|
| 159-093B | Blank | 159-140 | .140" | 159-157 | .157" | 159-176 | .176" | 159-192 | .192" | 159-213 | .213" |
| 159-80 | .080" | 159-144 | .144" | 159-158 | .158" | 159-177 | .177" | 159-193 | .193" | 159-221 | .221" |
| 159-116 | .116" | 159-146 | .146" | 159-161 | .161" | 159-180 | .180" | 159-196 | .196" | 159-228 | .228" |
| 159-120 | .120" | 159-148 | .148" | 159-166 | .166" | 159-184 | .184" | 159-199 | .199" | | |
| 159-125 | .125" | 159-149 | .149" | 159-169 | .179" | 159-185 | .185" | 159-201 | .201" | | |
| 159-128 | .128" | 159-149B | Blank | 159-172 | .172" | 159-188 | .188" | 159-205 | .205" | | |
| 159-136 | .136" | 159-154 | .154" | 159-173 | .173" | 159-189 | .189" | 159-209 | .209" | | |

ALCOHOL - METERING



| Walker # | Orifice | Walker # | Orifice | Walker # | Orifice | Walker # | Orifice | Walker # | Orifice | Walker # | Orifice |
|-------------|---------|------------|---------|------------|---------|------------|---------|------------|---------|------------|---------|
| 120-13-035b | 0.035 | 120-13-047 | 0.047 | 120-13-056 | 0.056 | 120-13-063 | 0.063 | 120-13-070 | 0.07 | 120-13-076 | 0.076 |
| 120-13-042 | 0.042 | 120-13-048 | 0.048 | 120-13-058 | 0.058 | 120-13-065 | 0.065 | 120-13-071 | 0.071 | 120-13-077 | 0.077 |
| 120-13-043 | 0.043 | 120-13-050 | 0.05 | 120-13-059 | 0.059 | 120-13-066 | 0.066 | 120-13-072 | 0.072 | 120-13-078 | 0.078 |
| 120-13-044 | 0.044 | 120-13-052 | 0.052 | 120-13-060 | 0.06 | 120-13-067 | 0.067 | 120-13-073 | 0.073 | 120-13-079 | 0.079 |
| 120-13-045 | 0.045 | 120-13-054 | 0.054 | 120-13-061 | 0.061 | 120-13-068 | 0.068 | 120-13-074 | 0.074 | 120-13-080 | 0.08 |
| 120-13-046 | 0.046 | 120-13-055 | 0.055 | 120-13-062 | 0.062 | 120-13-069 | 0.069 | 120-13-075 | 0.075 | 120-13-083 | 0.083 |



JETS

HOLLEY® STANDARD MAIN, CARTER JETS, METERING JETS & BLEEDS and RODS

HIGH PERFORMANCE PRODUCTS • CARBURETION • CARBURETOR REPAIR KITS

HOLLEY® STANDARD MAIN JETS



| WALKER # | H # | JET # | ORIFICE |
|------------|---------|-------|---------|
| 120-40-00 | | | BLANK |
| 120-40-33 | | | .033" |
| 120-40-35 | | | .035" |
| 120-40-37 | | | .037" |
| 120-40-38 | | | .038" |
| 120-40-39 | | | .039" |
| 120-40-40 | 122-40 | 40 | .040" |
| 120-40-41 | 122-41 | 41 | .041" |
| 120-40-42 | 122-42 | 42 | .042" |
| 120-40-43 | 122-43 | 43 | .043" |
| 120-40-44 | 122-44 | 44 | .044" |
| 120-40-45 | 122-45 | 45 | .045" |
| 120-40-46 | 122-46 | 46 | .046" |
| 120-40-47 | 122-47 | 47 | .047" |
| 120-40-48 | 122-48 | 48 | .048" |
| 120-40-49 | 122-49 | 49 | .048" |
| 120-40-50 | 122-50 | 50 | .049" |
| 120-40-51 | 122-51 | 51 | .050" |
| 120-40-52 | 122-52 | 52 | .052" |
| 120-40-53 | 122-53 | 53 | .052" |
| 120-40-54 | 122-54 | 54 | .053" |
| 120-40-55 | 122-55 | 55 | .054" |
| 120-40-56 | 122-56 | 56 | .055" |
| 120-40-57 | 122-57 | 57 | .056" |
| 120-40-58 | 122-58 | 58 | .057" |
| 120-40-59 | 122-59 | 59 | .058" |
| 120-40-60 | 122-60 | 60 | .060" |
| 120-40-61 | 122-61 | 61 | .060" |
| 120-40-62 | 122-62 | 62 | .061" |
| 120-40-63 | 122-63 | 63 | .062" |
| 120-40-100 | 122-100 | 100 | .128" |
| 120-40-101 | 122-101 | 101 | .129" |
| 120-40-102 | 122-102 | 102 | .132" |
| 120-40-103 | 122-103 | 103 | .135" |
| 120-40-104 | 122-104 | 104 | .139" |
| 120-40-105 | 122-105 | 105 | .144" |
| 120-40-106 | 122-106 | 106 | .145" |
| 120-40-107 | 122-107 | 107 | .148" |
| 120-40-108 | 122-108 | 108 | .145" |
| 120-40-109 | 122-109 | 109 | .165" |
| 120-40-110 | 122-110 | 110 | .167" |

HOLLEY® ALCOHOL METERING JETS



| WALKER # | ORIFICE |
|----------|------------|
| 159-80 | .080 ID |
| 159-093B | .093 BLANK |
| 159-146 | .146 ID |
| 159-148 | .148 ID |
| 159-149B | .149 BLANK |
| 159-158 | .158 ID |
| 159-172 | .172 ID |
| 159-176 | .176 ID |
| 159-184 | .184 ID |
| 159-188 | .188 ID |
| 159-192 | .192 ID |
| 159-196 | .196 ID |

HOLLEY® METERING RODS



| WALKER # | DIAMETER |
|----------|----------------|
| 130-43 | 0.043 diameter |
| 130-45 | 0.045 diameter |
| 130-50 | 0.050 diameter |

CARTER AFB METERING ROD



| Walker # | OEM # |
|----------|---------|
| 130-5749 | 16-5749 |
| 130-6252 | 16-6252 |
| 130-6337 | 16-6337 |
| 130-6347 | 16-6347 |
| 130-6537 | 16-6537 |
| 130-6547 | 16-6547 |
| 130-6552 | 16-6552 |
| 130-6557 | 16-6557 |
| 130-6749 | 16-6749 |
| 130-6755 | 16-6755 |
| 130-6842 | 16-6842 |
| 130-6847 | 16-6847 |
| 130-6852 | 16-6852 |
| 130-6857 | 16-6857 |
| 130-7037 | 16-7037 |
| 130-7042 | 16-7042 |
| 130-7047 | 16-7047 |
| 130-7052 | 16-7052 |
| 130-7057 | 16-7057 |
| 130-7147 | 16-7147 |
| 130-7337 | 16-7337 |
| 130-7342 | 16-7342 |
| 130-7347 | 16-7347 |
| 130-7352 | 16-7352 |
| 130-7537 | 16-7537 |
| 130-7542 | 16-7542 |
| 130-7547 | 16-7547 |

CARTER JETS



| WALKER # | WALKER # |
|-------------|------------|
| 120-27-030 | 120-27-077 |
| 120-27-030B | 120-27-078 |
| 120-27-040B | 120-27-080 |
| 120-27-045 | 120-27-082 |
| 120-27-045B | 120-27-083 |
| 120-27-046 | 120-27-085 |
| 120-27-047 | 120-27-086 |
| 120-27-048 | 120-27-087 |
| 120-27-049 | 120-27-088 |
| 120-27-050 | 120-27-089 |
| 120-27-051 | 120-27-090 |
| 120-27-052 | 120-27-091 |
| 120-27-053 | 120-27-092 |
| 120-27-054 | 120-27-093 |
| 120-27-055 | 120-27-094 |
| 120-27-056 | 120-27-095 |
| 120-27-058 | 120-27-096 |
| 120-27-059 | 120-27-097 |
| 120-27-060 | 120-27-098 |
| 120-27-062 | 120-27-099 |
| 120-27-063 | 120-27-100 |
| 120-27-064 | 120-27-101 |
| 120-27-065 | 120-27-102 |
| 120-27-066 | 120-27-104 |
| 120-27-067 | 120-27-105 |
| 120-27-068 | 120-27-107 |
| 120-27-069 | 120-27-108 |
| 120-27-070 | 120-27-109 |
| 120-27-071 | 120-27-110 |
| 120-27-072 | 120-27-111 |
| 120-27-073 | 120-27-113 |
| 120-27-074 | 120-27-116 |
| 120-27-075 | 120-27-119 |
| 120-27-076 | 120-27-120 |

ORIFICE: .023"



ADJUSTABLE AIR BLEED
85-611
(Specify Orifice)



ADJUSTABLE AIR BLEED
120-7
SIZE 12-28 (Specify Orifice)



ADJUSTABLE AIR BLEED
120-8
(Specify Orifice)

ORIFICE: .021"



OD: .011"
PRESS-IN BLEED
85-607

ORIFICE: .016"



OD: .122"
PRESS-IN BLEED
85-608

ORIFICE: .020"



OD: .125"
PRESS-IN BLEED
85-613

NUT: 15/16"



ID: 1/4" - 32
OD: 1/4" - 32
MAIN JET EXTENSION
85-723

FUEL INJECTION • OXYGEN SENSORS • BUNGS & PLUGS • ENGINE MANAGEMENT

WPA-2001 - .073 - .090



| WALKER # | H # | JET # | ORIFICE | QTY | WALKER # | H # | JET # | ORIFICE | QTY | WALKER # | H # | JET # | ORIFICE | QTY |
|-----------|--------|-------|---------|-----|-----------|--------|-------|---------|-----|-----------|--------|-------|---------|-----|
| 120-40-73 | 122-73 | 73 | .079" | 4 | 120-40-79 | 122-79 | 79 | .091" | 4 | 120-40-85 | 122-85 | 85 | .100" | 4 |
| 120-40-74 | 122-74 | 74 | .081" | 4 | 120-40-80 | 122-80 | 80 | .093" | 4 | 120-40-86 | 122-86 | 86 | .101" | 4 |
| 120-40-75 | 122-75 | 75 | .082" | 4 | 120-40-81 | 122-81 | 81 | .093" | 4 | 120-40-87 | 122-87 | 87 | .103" | 4 |
| 120-40-76 | 122-76 | 76 | .084" | 4 | 120-40-82 | 122-82 | 82 | .093" | 4 | 120-40-88 | 122-88 | 88 | .104" | 4 |
| 120-40-77 | 122-77 | 77 | .086" | 4 | 120-40-83 | 122-83 | 83 | .094" | 4 | 120-40-89 | 122-89 | 89 | .104" | 4 |
| 120-40-78 | 122-78 | 78 | .089" | 4 | 120-40-84 | 122-84 | 84 | .099" | 4 | 120-40-90 | 122-90 | 90 | .104" | 4 |

WPA-2002 - .064 - .072 & .091 - .099



| WALKER # | H # | JET # | ORIFICE | QTY | WALKER # | H # | JET # | ORIFICE | QTY | WALKER # | H # | JET # | ORIFICE | QTY |
|-----------|--------|-------|---------|-----|-----------|--------|-------|---------|-----|-----------|--------|-------|---------|-----|
| 120-40-64 | 122-64 | 64 | .064" | 4 | 120-40-70 | 122-70 | 70 | .073" | 4 | 120-40-94 | 122-94 | 94 | .108" | 4 |
| 120-40-65 | 122-65 | 65 | .065" | 4 | 120-40-71 | 122-71 | 71 | .076" | 4 | 120-40-95 | 122-95 | 95 | .118" | 4 |
| 120-40-66 | 122-66 | 66 | .066" | 4 | 120-40-72 | 122-72 | 72 | .079" | 4 | 120-40-96 | 122-96 | 96 | .118" | 4 |
| 120-40-67 | 122-67 | 67 | .068" | 4 | 120-40-91 | 122-91 | 91 | .105" | 4 | 120-40-97 | 122-97 | 97 | .125" | 4 |
| 120-40-68 | 122-68 | 68 | .069" | 4 | 120-40-92 | 122-92 | 92 | .105" | 4 | 120-40-98 | 122-98 | 98 | .125" | 4 |
| 120-40-69 | 122-69 | 69 | .070" | 4 | 120-40-93 | 122-93 | 93 | .105" | 4 | 120-40-99 | 122-99 | 99 | .125" | 4 |

| | | | | | | |
|---|---|---|--|--|--|---|
|  ACCELERATOR PUMP TRANSFER TUBE 85-646 |  BRASS PUMP DISCHARGE NEEDLE 17-66 |  "C" CLIP RETAINER 62-94 |  DIAPHRAGM COVER SCREW (OE Style) 80-239 |  DIAPHRAGM RETURN SPRING 50cc 66-151 |  DIAPHRAGM SPRING HEAVY 30cc 66-150 | |
|  DIAPHRAGM SPRING LIGHT 30cc 66-149 |  "E" CLIP RETAINER 62-47 |  PUMP ARM (Early Style) STEEL 30cc 85-521 |  PUMP ARM 4150 50cc 85-519 |  PUMP ARM 4500 DOMINATOR 50cc 85-520 | | |
|  PUMP ARM PLASTIC 30cc 85-472 |  PUMP ARM STEEL 30cc 85-522 | |  PUMP ARM STUD 22-162 |  PUMP ARM STUD (Early Style) 22-173 | | |
|  PUMP CAM 85-176 WHITE - 2 HOLES |  PUMP CAM 85-439 BLACK - 2 HOLES |  PUMP CAM 85-440 RED - 2 HOLES |  PUMP CAM W/SHOULDERS 85-441 BLUE - 2 HOLES |  PUMP CAM 85-442 ORANGE - 2 HOLES |  PUMP CAM 85-443 GREEN - 2 HOLES |  PUMP CAM 85-444 PINK - 3 HOLES |
|  PUMP CAM 85-445 BROWN - 1 HOLE |  PUMP CAM W/SHOULDERS 85-503 BROWN - 2 HOLES |  PUMP CAM DOMINATOR W/SHOULDERS 85-504 YELLOW - 1 HOLE |  PUMP CAM DOMINATOR 85-528 WHITE - 2 HOLES |  PUMP CAM SCREW (OE Style) 80-223 |  PUMP COVER ARM 30cc 85-518 | |
|  PUMP COVER ARM 50cc 85-529 |  PUMP COVER HOUSING ASSEMBLY 30cc 85-568 | |  PUMP COVER HOUSING ASSEMBLY 50cc 85-570 | |  PUMP COVER SCREW (OE Style) 30cc 80-247 | |
|  PUMP DIAPHRAGM ASSEMBLY (Green GFLT) 30cc 64-473 | | |  PUMP DIAPHRAGM ASSEMBLY (Green GFLT) 50cc 64-472 | | | |

HOLLEY® ACCELERATOR PUMPS & COMPONENTS

FUEL INJECTION • OXYGEN SENSORS • BUNGS & PLUGS • ENGINE MANAGEMENT

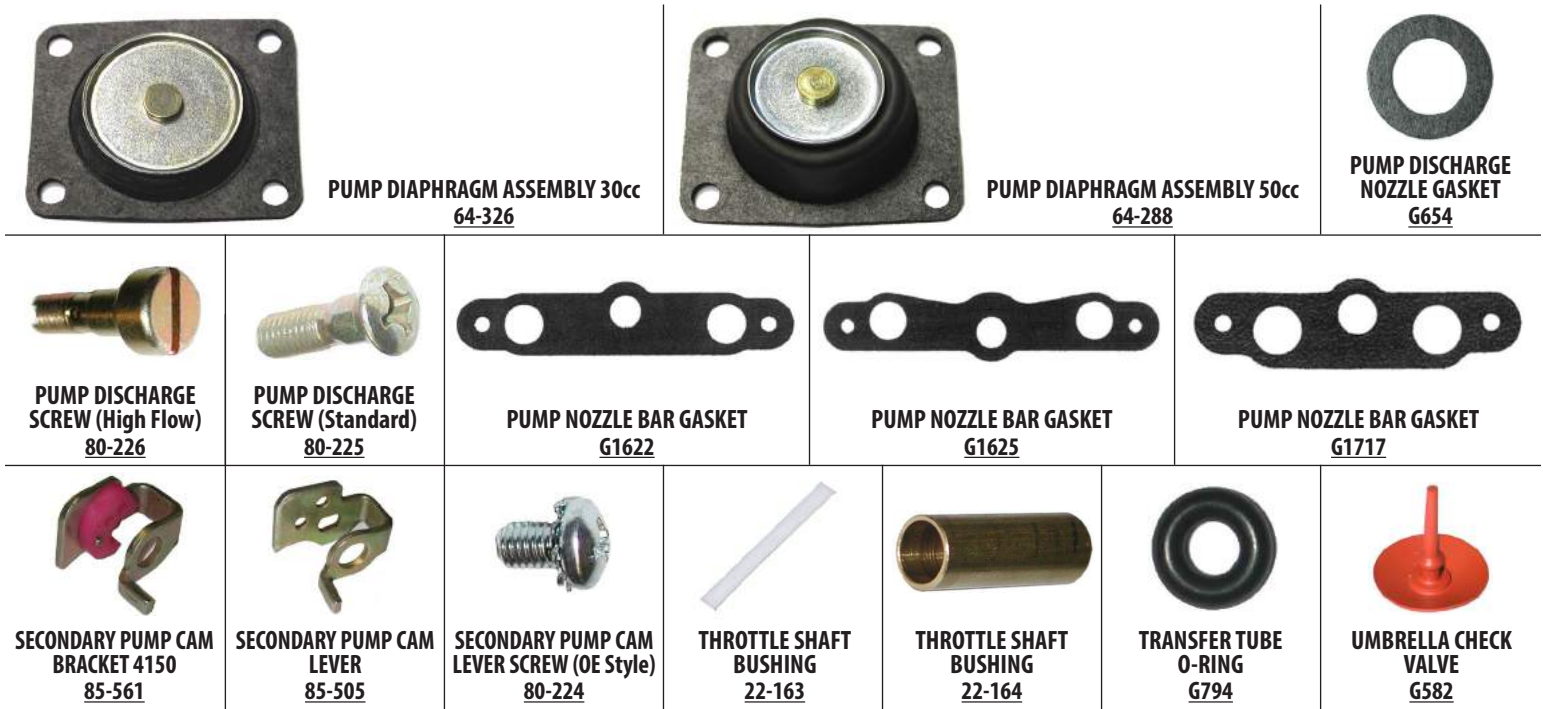

PUMP DISCHARGE NOZZLES

STRAIGHT TYPE



| Walker # | H # | Hole Size |
|----------|---------|-----------|
| 85-728 | 121-121 | .021" |
| 85-207 | 121-125 | .025" |
| 85-295 | 121-128 | .028" |
| 85-446 | 121-131 | .031" |
| 85-447 | 121-132 | .032" |
| 85-448 | 121-135 | .035" |
| 85-449 | 121-137 | .037" |
| 85-450 | 121-140 | .040" |
| 85-506 | 121-141 | .042" |
| 85-507 | 121-145 | .045" |
| 85-508 | 121-147 | .047" |
| 85-509 | 121-150 | .050" |
| 85-510 | 121-152 | .052" |

TUBE TYPE



| Walker # | H # | Hole Size |
|----------|--------|-----------|
| 85-451 | 121-25 | .025" |
| 85-305 | 121-28 | .028" |
| 85-511 | 121-31 | .031" |
| 85-452 | 121-35 | .035" |
| 85-513 | 121-37 | .037" |
| 85-514 | 121-40 | .040" |
| 85-515 | 121-42 | .042" |
| 85-516 | 121-45 | .045" |

ANTI-PULLOVER TYPE



| Walker # | H # | Hole Size |
|----------|---------|-----------|
| 85-530 | 121-225 | .025" |
| 85-531 | 121-228 | .028" |
| 85-532 | 121-231 | .031" |
| 85-533 | 121-237 | .037" |
| 85-534 | 121-240 | .040" |
| 85-535 | 121-242 | .042" |
| 85-536 | 121-245 | .045" |
| 85-537 | 121-247 | .047" |
| 85-538 | 121-250 | .050" |
| 85-539 | 121-252 | .052" |

QUALITY • COVERAGE • SUPPORT





**BASE PLATE COMPLETE ASSEMBLY
85-717**



**BASE PLATE COMPLETE ASSEMBLY
85-724**

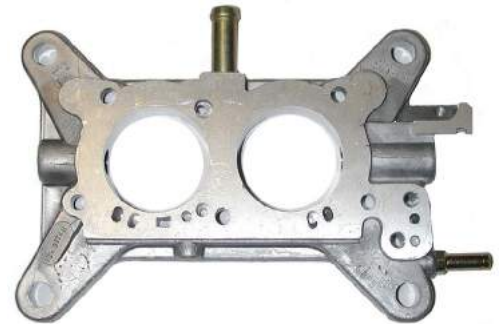

**BARE BASE PLATE ASSEMBLY
85-677**

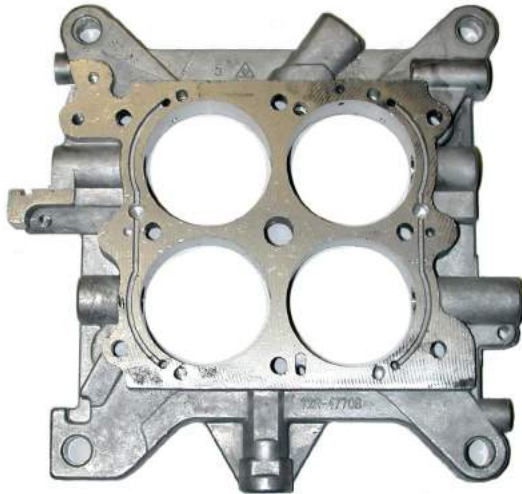

**BARE BASE PLATE ASSEMBLY
85-580**

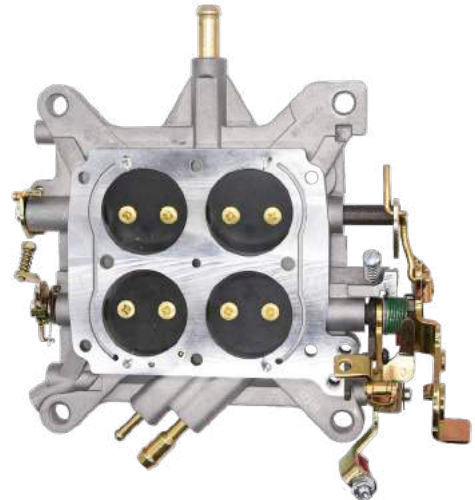

**BASE PLATE COMPLETE ASSEMBLY
85-668**

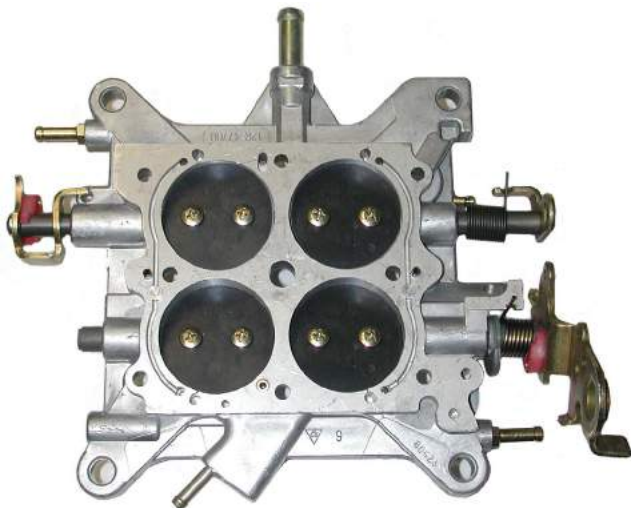

**BASE PLATE COMPLETE ASSEMBLY
85-673**



**BASE PLATE COMPLETE ASSEMBLY
85-674**

HOLLEY® BASE PLATE COMPONENTS & THROTTLE PLATES

FUEL INJECTION • OXYGEN SENSORS • BUNGS & PLUGS • ENGINE MANAGEMENT

| | | | | | | |
|--|--|--|---|--|--|---|
|  "C" CLIP RETAINER 62-94 |  "E" CLIP RETAINER 62-47 |  IDLE SCREW WASHER CORK G283 |  IDLE SCREW WITHOUT O-RING 16-155 4180 MUSTANG/FORD TRUCK 6-32 x 61/64" |  PUMP ARM STUD 22-162 |  PUMP ARM STUD (Early Style) 22-173 |  SECONDARY RETURN SPRING PIN 85-562 |
|  SECONDARY THROTTLE ADJUSTING SCREW 80-231 M5 x .8" x 3/8" |  STEEL TUBE 17-168 3/16" x 1.0" |  THROTTLE BODY SCREW (OE Style) 80-248 12-24 x 3/4" |  THROTTLE LEVEL BALL STUD 22-16 |  THROTTLE PLATE SCREW 80-236 8-32 x 3/16" |  THROTTLE PLATE SCREW (OE Style Stamped "H") 80-42 8-32 x 5/16" |  THROTTLE PLATE SCREW (OE Style) 80-246 8-32 x 9/32" |
|  THROTTLE PLATE SCREW (OE Style) 80-199 8-32 x 5/16" |  THROTTLE SHAFT BUSHING - TEFLON 22-163 THICKNESS .015" |  THROTTLE SHAFT BUSHING 22-164 |  THROTTLE STOP SCREW (NON-OE) 80-87 10-32 x 1.0" |  THROTTLE STOP SCREW (OE Style) 80-230 10-32 x 1-3/32" |  THROTTLE STOP SCREW SPRING 66-175 |  TUBE 17-194 |

HOLLEY THROTTLE PLATES



| Walker # | Size | Stamped |
|----------|--|---------|
| 85-454 | 1-7/16" PRIMARY | 96 |
| 85-456 | 1-7/16" SECONDARY | 103 |
| 85-655 | 1-7/16" PRIMARY 390HP W/.152 BYPASS | 327 |
| 85-656 | 1-7/16" SECONDARY 390 HP W/.152 BYPASS | 328 |
| 85-287 | 1-15/32" | 259 |
| 85-461 | 1-1/2" | 107 |
| 85-462 | 1-9/16" | 109 |
| 85-653 | 1-9/16" | 267 |
| 85-654 | 1-9/16" BRASS | 268 |
| 85-652 | 1-9/16" STAINLESS | 344 |
| 85-455 | 1-11/16" THIN | 172 |
| 85-457 | 1-11/16" W/.093 BYPASS | 215 |
| 85-657 | 1-11/16" STAINLESS | 354 |
| 85-659 | 1-11/16" STAINLESS - 830 HP | 329 |
| 85-458 | 1-3/4" ALUMINUM | 289 |
| 85-718 | 1-3/4" | 180 |
| 85-651 | 1-3/4" STAINLESS | 326 |
| 85-464 | 2" | 228 |
| 85-658 | 2-1/8" | 342 |

HIGH PERFORMANCE PRODUCTS • CARBURETION • CARBURETOR REPAIR KITS



ID: .646"

ANNULAR BOOSTER
85-438



ANNULAR BOOSTER BANJO
85-499



ID: .600"

ANNULAR BOOSTER INSERT
85-498



ANNULAR BOOSTER HOUSING
85-622
Model 4500 HP



ANNULAR BOOSTER - SHORT
85-621 NEW STYLE HP, MODEL 4500
84-496 OLD STYLE, MODEL 4500



ANNULAR BOOSTER - SKIRTED
85-494
MODEL 4500 HP



ANNULAR BOOSTER - TALL
85-493
MODEL 4500



BOOSTER STAKE TUBES
85-500



DOMINATOR BOOSTER INSERT
85-730



DOUBLE-STEP DOWN (DOG) LEG BOOSTER
85-501 ORIFICE .180"
85-502 ORIFICE .160"
85-623 ORIFICE .170"



DOWN (DOG) LEG BOOSTER
85-436 ORIFICE .160"
85-460 ORIFICE .140"



STRAIGHT LEG BOOSTER
85-435 ORIFICE .135"
85-490 ORIFICE .144"
85-617 ORIFICE .125"



STRAIGHT LEG BOOSTER WITH SMALL SKIRT
85-491
ORIFICE .140"

HOLLEY® CHOKES & COMPONENTS

FUEL INJECTION • OXYGEN SENSORS • BUNGS & PLUGS • ENGINE MANAGEMENT

| | | | | |
|--|---|--|---|---|
|  <p>CHOKE HOUSING GASKET G282</p> |  <p>CHOKE HOUSING TO BODY SCREW (OE Style) 80-243 8-32 x 1-5/32"</p> |  <p>CHOKE PLATE 85-661 MODEL 2300 & 4500</p> |  <p>CHOKE PLATE 85-662 MODEL 4781-1</p> |  <p>CHOKE PLATE 85-663 MODEL 3310-4 & 4779-6</p> |
|  <p>CHOKE PLATE 85-664 MODEL 4412-2</p> |  <p>CHOKE PLATE 85-665 MODEL 1050</p> |  <p>CHOKE PULL-OFF 101-543</p> |  <p>CHOKE SHAFT (For Screw in Plate) 20-95</p> |  <p>CHOKE SHAFT (For Slide in Plate) 20-96</p> |
|  <p>CHOKE STOVE GASKET G1218</p> |  <p>THICKNESS: .031" OD: 2.185" ID: 1.880" CHOKE THERMOSTAT COVER GASKET 243F</p> |  <p>THICKNESS: .046" OD: 2.240" ID: 1.873" CHOKE THERMOSTAT COVER GASKET G97-1</p> |  <p>THICKNESS: 1/32" CHOKE THERMOSTAT COVER GASKET G243</p> |  <p>THICKNESS: .046" OD: 2.180" ID: 1.890" CHOKE THERMOSTAT COVER GASKET G509</p> |
|  <p>THICKNESS: .046" OD: 2.230" ID: 1.890" CHOKE THERMOSTAT COVER GASKET G918</p> |  <p>THICKNESS: 1/32" CHOKE THERMOSTAT COVER GASKET G1320</p> |  <p>THICKNESS: 1/16" CHOKE THERMOSTAT COVER GASKET G1336</p> |  <p>CHOKE & THROTTLE PLATE SCREW (OE Style) 80-5 6-32 x 1/4"</p> | |
|  <p>ELECTRIC CHOKE KICKDOWN LEVER 85-471</p> |  <p>ELECTRIC CHOKE THERMOSTAT 102-1082</p> |  <p>FAST IDLE CAM 85-459</p> |  <p>FAST IDLE CAM PLATE SCREW (OE Style) 80-245 8-32 x 1-7/16"</p> | |

QUALITY • COVERAGE • SUPPORT



ELECTRIC CHOKE KIT HOLLEY 45-223



| Walker # | Description |
|-----------|---|
| G282 | CHOKE HOUSING GASKET (QTY 2) |
| G918 | CHOKE THERMOSTAT COVER GASKET |
| 62-46 | ROD RETAINER |
| 85-78 | THERMOSTAT COVER RETAINER |
| 80-243 | CHOKE HOUSING TO BODY SCREW (QTY 3) |
| 80-45 | CHOKE CONTROL WIRE BRACKET SCREW (QTY 3) |
| 80-234 | FAST IDLE CAM LEVER SCREW |
| 85-471 | ELECTRIC CHOKE KICK DOWN LEVER |
| 85-630 | CHOKE HOUSING ASSEMBLY |
| 66-51 | FAST IDLE CAM LEVER ADJUSTMENT SCREW SPRING |
| R152 | CONVERTS MECHANICAL TO ELECTRIC CHOKE |
| 102-1082 | ELECTRIC CHOKE THERMOSTAT |
| 85-666 | WIRE & TERMINAL ASSEMBLY |
| 85-667 | WIRE ASSEMBLY |
| 5/32 HOSE | VACUUM HOSE |

ELECTRIC CHOKE KIT HOLLEY 45-224



| Walker # | Description |
|----------|---|
| 83-3 | LEAD BALL PLUG |
| 17-193 | VACUUM TEE CONNECTOR |
| G918 | CHOKE THERMOSTAT COVER GASKET |
| 62-46 | ROD RETAINER |
| 85-78 | THERMOSTAT COVER RETAINER |
| 80-243 | CHOKE HOUSING TO BODY SCREW (QTY 3) |
| 80-45 | CHOKE CONTROL WIRE BRACKET SCREW (QTY 3) |
| 80-234 | FAST IDLE CAM LEVER SCREW |
| 80-221 | CHOKE HOUSING SCREW (QTY 3) |
| 85-612 | CHOKE HOUSING SPACER (QTY 3) |
| 85-471 | ELECTRIC CHOKE KICK DOWN LEVER |
| 85-631 | CHOKE HOUSING ASSEMBLY |
| 66-51 | FAST IDLE CAM LEVER ADJUSTMENT SCREW SPRING |
| R152 | CONVERTS MECHANICAL TO ELECTRIC CHOKE |
| 102-1082 | WIRE & TERMINAL ASSEMBLY |
| 85-666 | WIRE & TERMINAL ASSEMBLY |
| 1/8 HOSE | VACUUM HOSE |

MANUAL CHOKE KIT HOLLEY 45-225



| Walker # | Description |
|----------|-----------------------------------|
| 83-3 | LEAD BALL PLUG |
| 81-2 | COVER NUT |
| 80-245 | FAST IDLE CAM PLATE SCREW (QTY 3) |
| 80-45 | CHOKE CONTROL WIRE BRACKET SCREW |
| 85-614 | CHOKE LEVER & SWIVEL |
| 85-615 | FAST IDLE CAM LEVER |
| 85-616 | FAST IDLE CAM LEVER P/U LEVER |
| 85-628 | CHOKE CONTROL BRACKET CLAMP |
| 85-629 | CHOKE WIRE BRACKET |
| 85-632 | BACK-UP PLATE ASSEMBLY |
| 85-633 | FAST IDLE CAM & PLATE ASSEMBLY |
| 85-634 | CHOKE WIRE BRACKET |
| 66-181 | FAST IDLE CAM LEVER SPRING |
| G600-4 | VACUUM TUBE CAP (QTY 2) |



PRIMARY DOUBLE PUMP BOWL W/GLASS WINDOW
85-752



PRIMARY FLOAT BOWL (CENTER HUNG)
85-523
4150/DOUBLE PUMPER



PRIMARY FLOAT BOWL (MARINE)
85-712



PRIMARY FLOAT BOWL (SIDE HUNG)
85-582
MODEL 4160



PRIMARY FLOAT BOWL DOMINATOR (DUAL INLET)
85-525



SECONDARY DOUBLE PUMP BOWL W/GLASS WINDOW
85-746



SECONDARY FLOAT BOWL (CENTER HUNG)
85-524
MODEL 4150/DOUBLE PUMPER



SECONDARY FLOAT BOWL (CENTER HUNG)
85-542
MODEL 4160

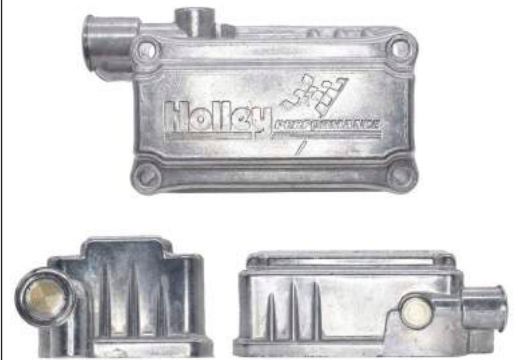

SECONDARY FLOAT BOWL DICHROMATE
85-735



SECONDARY FLOAT BOWL DOMINATOR (DUAL INLET)
85-526



SECONDARY FUEL BOWL ASSEMBLY W/GLASS WINDOW
85-747



VACUUM SECONDARY FLOAT BOWL (DUAL INLET)
85-527



FUEL BOWL SCREW WASHER
G1194
RUBBER COATED ALUMINUM



FUEL BOWL SCREW
25-23
12-24 x 2"



FUEL BOWL SCREW
25-24
12-24 x 1-3/8"



THICKNESS: .062" OD: 380"
Float Bowl Screw Gasket
G1110
G1733 - NYLON



FUEL BOWL VENT SCREEN
85-638



THICKNESS: .062" OD: 1.032"
FUEL FITTING GASKET
G1126
TEFLON

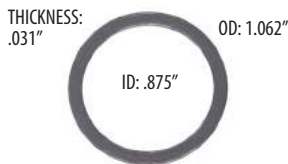

THICKNESS: .031" OD: 1.062"
FUEL FITTING WASHER
G778
RUBBER COATED ALUMINUM



NUT: 11/16" OD: 9/16" - 24
ID: 1/2" - 20
FUEL FITTING INLET
90-10



NUT: 9/16" OD: 9/16" - 20
ID: 1/2" - 20
FUEL FITTING INLET
90-140



NUT: 1" OD: 7/8" - 20
ID: 1/2" - 20
FUEL FITTING INLET
90-72



NUT: 1" OD: 7/8" - 20
ID: 5/8" - 18
FUEL FITTING INLET - (OE Style)
90-178



THICKNESS: .031" OD: .710"
ID: .567"
FUEL INLET FITTING GASKET
G1206
RUBBER COATED ALUMINUM

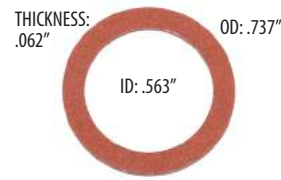

THICKNESS: .062" OD: .737"
ID: .563"
FUEL INLET FITTING GASKET
G49



NUT: 3/4" OD: 9/16" - 24
ID: 5/8" - 18
FUEL INLET FITTING GOVERNOR
90-99



NUT: 11/16" OD: 9/16" - 24
3/8" FUEL INLET FITTING HOSE
90-175



NUT: 11/16" OD: 9/16" - 24
5/16" FUEL INLET FITTING HOSE
90-176

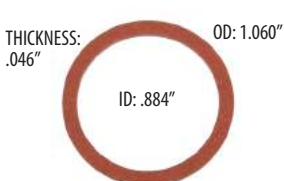

THICKNESS: .046" OD: 1.060"
ID: .884"
FUEL INLET FITTING WASHER
G1125

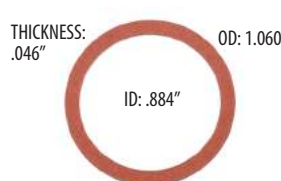

THICKNESS: .046" OD: 1.060"
ID: .884"
FUEL INLET FITTING WASHER
G418



NUT: 1" OD: 7/8" - 20
FUEL INLET PLUG
90-174



HOSE: 5/16" OD: 9/16" - 24
FUEL INLET SWIVEL FITTING
90-163

HOLLEY® FLOAT BOWL COMPONENTS

FUEL INJECTION • OXYGEN SENSORS • BUNGS & PLUGS • ENGINE MANAGEMENT

| | | | | |
|--|--|---|--|---|
| <p>THICKNESS: .025"</p>  <p>FUEL INLET WASHER G1502 RUBBER COATED ALUMINUM</p> |  <p>FUEL LEVEL SIGHT PLUG 85-517</p> | <p>THICKNESS: .031" OD: .500"</p>  <p>ID: .314"</p> <p>FUEL LEVEL SIGHT PLUG GASKET 670F COPPER</p> | <p>THICKNESS: .031" OD: .459"</p>  <p>ID: .323"</p> <p>FUEL LEVEL SIGHT PLUG GASKET G1140 RUBBER COATED ALUMINUM</p> | <p>THICKNESS: .031" OD: .437"</p>  <p>ID: .312"</p> <p>FUEL LEVEL SIGHT PLUG GASKET G59 FIBER</p> |
|  <p>FUEL TRANSFER TUBE 85-647 LENGTH 5-1/2" 85-648 LENGTH 6-3/16" 85-649 LENGTH 7"</p> |  <p>FUEL TRANSFER TUBE SEAL 85-624</p> |  <p>HELICAL INSERT 86-1005 SIZE 12-24</p> |  <p>NEEDLE & SEAT ADJUSTING NUT 85-338</p> |  <p>NEEDLE & SEAT SCREW 85-337</p> |
|  <p>PLAIN INSTALLING TOOL 86-3005 SIZE 12-24</p> |  <p>PRIMARY FUEL BOWL SCREW 25-7 SIZE 12-24</p> |  <p>PRIMARY FUEL INLET BAFFLE 85-636</p> | <p>THICKNESS: .070" OD: .379"</p>  <p>ID: .239"</p> <p>PUMP STEM SEAL O-RING G272</p> | <p>THICKNESS: .031" OD: .554"</p>  <p>ID: .404"</p> <p>QUICK CHANGE BOWL JET PLUG GASKET 397F</p> |
|  <p>SECONDARY FUEL BOWL SCREW 25-20 12-24x1-78"</p> |  <p>SECONDARY FUEL INLET BAFFLE 85-637</p> |  <p>SEE THRU FUEL LEVEL SIGHT PLUG 85-606</p> |  <p>TAP 86-2005 SIZE 12-24</p> |  <p>VENT VALVE SEAL 85-601</p> |

QUALITY • COVERAGE • SUPPORT





BRASS FLOAT (CENTER HUNG)
100-102



BRASS FLOAT (SIDE HUNG)
100-103



FLOAT BRACKET
85-627



FLOAT BRACKET SCREW (OE Style)
80-237
6-32 x 9/16"



FLOAT BUMPER SPRING (CENTER HUNG)
66-179



OVERALL
LENGTH:
968"

OD: .125"

FLOAT PIN
32-32



NITROPHYL FLOAT (CENTER HUNG)
100-79



NITROPHYL FLOAT (SIDE HUNG)
100-98



NOTCHED NITROPHYL FLOAT
(Use with 85-723 Jet Extension)
100-153



PLASTIC FLOAT (CENTER HUNG)
100-149



PRIMARY FLOAT SPRING (SIDE HUNG)
66-75



SECONDARY FLOAT SPRING (SIDE HUNG)
66-180

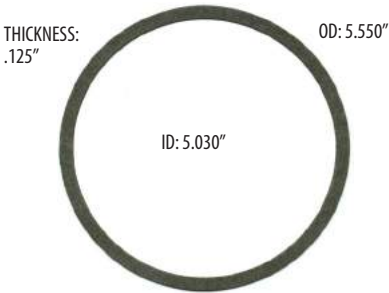

AIR CLEANER GASKET
G1857
 STANDARD MATERIAL - BLACK

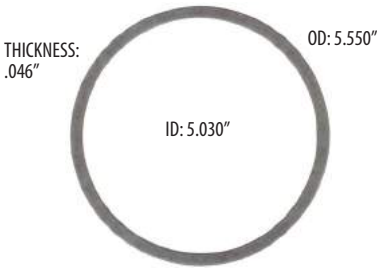

AIR CLEANER GASKET
G702 STANDARD MATERIAL - BLACK
G702BL NON-STICK - BLUE

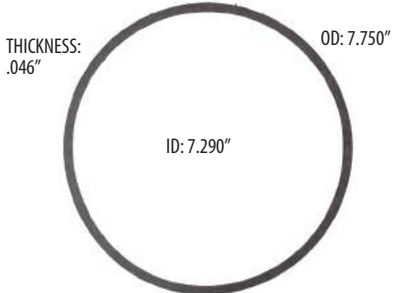

AIR CLEANER GASKET - DOMINATOR
G1889
 STANDARD MATERIAL - BLACK

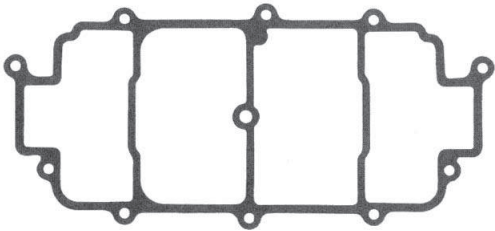

AIR HORN GASKET
G1620 STANDARD MATERIAL - BLACK
G1620BL NON-STICK - BLUE

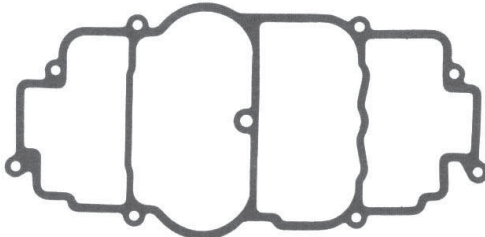

AIR HORN GASKET
G1621 STANDARD MATERIAL - BLACK
G1621BL NON-STICK - BLUE

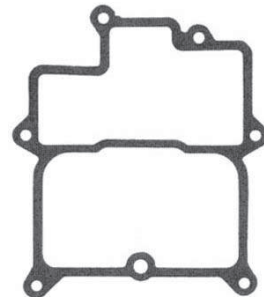

AIR HORN GASKET
G1780
 STANDARD MATERIAL - BLACK

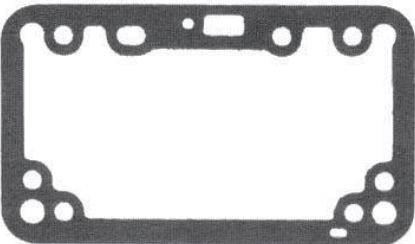

FUEL BOWL GASKET
G1046 NITRILE - BLACK
G1046BL NON-STICK - BLUE

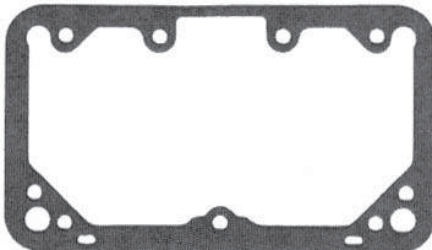

FUEL BOWL GASKET
G1056 NITRILE - BLACK
G1056BL NON-STICK - BLUE

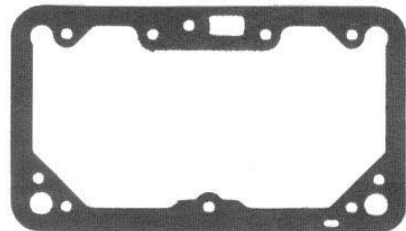

FUEL BOWL GASKET
G1063 NITRILE - BLACK
G1063BL NON-STICK - BLUE

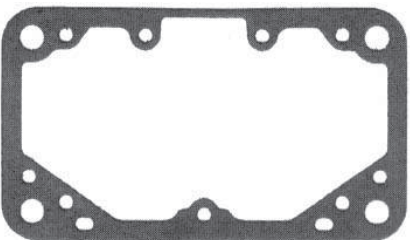

FUEL BOWL GASKET
G1329 NITRILE - BLACK
G1329BL NON-STICK - BLUE

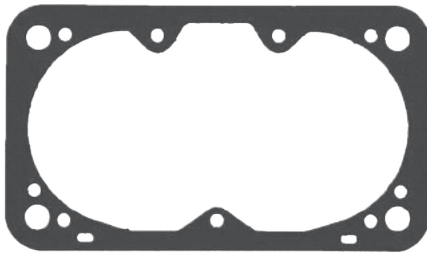

AIR HORN GASKET
G1863 NITRILE - BLACK
G1863BL NON-STICK - BLUE

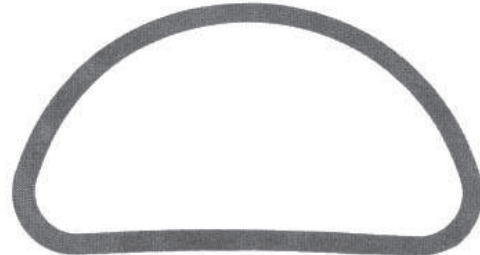

TRI POWER AIR CLEANER GASKET
G1812
 BUNA RUBBER - BLACK

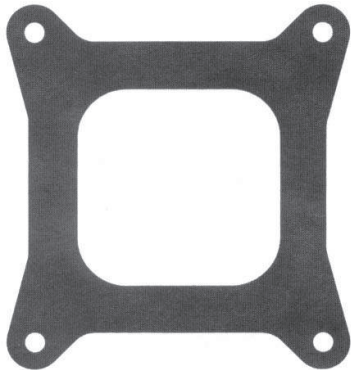

FLANGE GASKET
G669 - THICKNESS 1/32"
G1468 - THICKNESS 3/64"
G1742 - THICKNESS 9/64"
MODEL 4150/4160

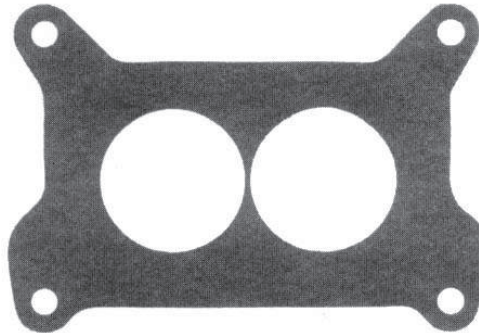

FLANGE GASKET
G765
MODEL 2300

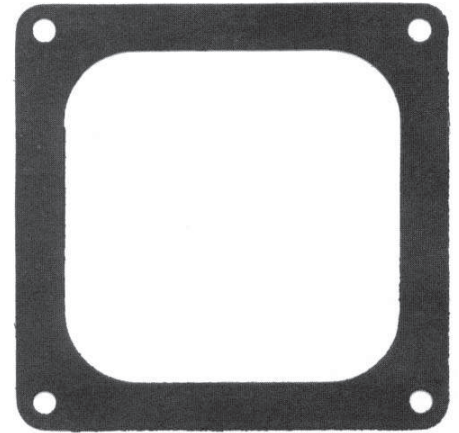

FLANGE GASKET DOMINATOR
G954

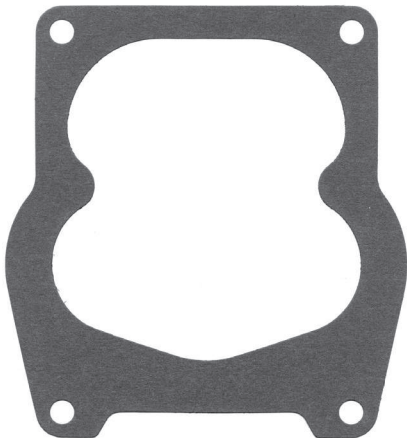

FLANGE GASKET
G999

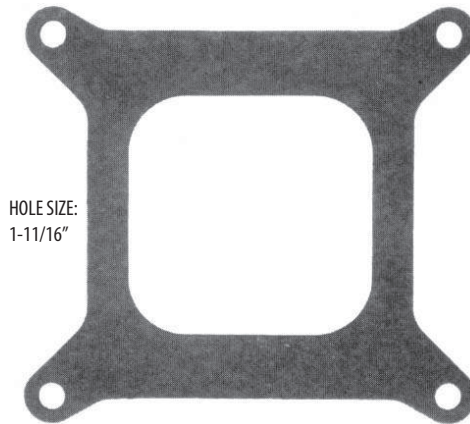

HOLE SIZE:
1-11/16"

FLANGE GASKET
G1064
MODEL 4160

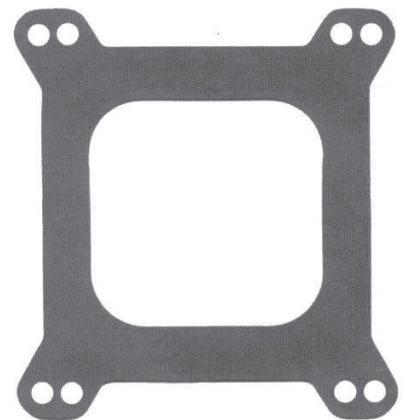

FLANGE GASKET
G1407 STANDARD MATERIAL - BLACK
G1407BL NON-STICK - BLUE

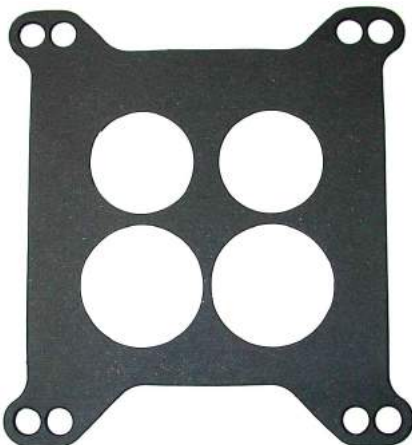

FLANGE GASKET
G1646

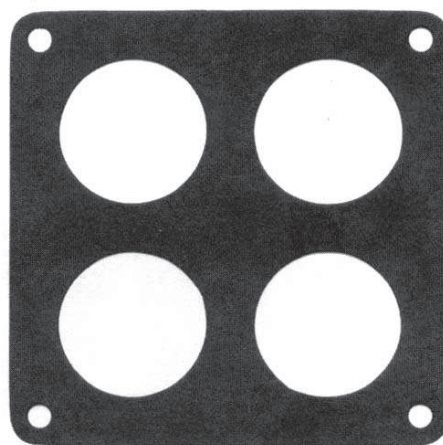

FLANGE GASKET DOMINATOR
G1800



FLANGE GASKET
G1881 STANDARD MATERIAL - BLACK
G1881BL NON-STICK - BLUE

HOLLEY®

GASKETS - METERING BLOCK

FUEL INJECTION • OXYGEN SENSORS • BUNGS & PLUGS • ENGINE MANAGEMENT

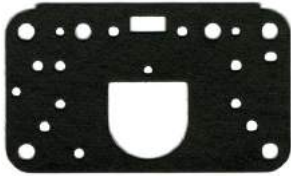

METERING BLOCK GASKET
G667 NITRILE - BLACK
G667BL NON-STICK - BLUE

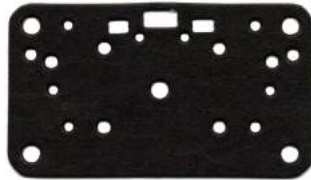

METERING BLOCK GASKET
G730 NITRILE - BLACK
G730BL NON-STICK - BLUE

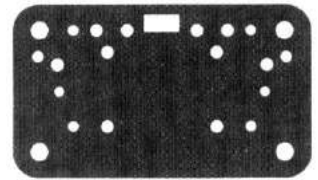

METERING BLOCK GASKET
G732 NITRILE - BLACK
G732BL NON-STICK - BLUE

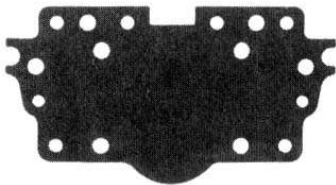

METERING BLOCK GASKET
G758 NITRILE - BLACK
G758BL NON-STICK - BLUE

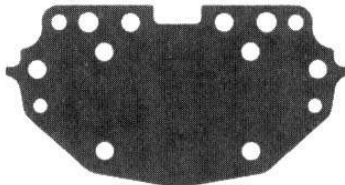

METERING BLOCK GASKET
G761 NITRILE - BLACK
G761BL NON-STICK - BLUE

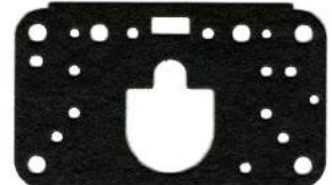

METERING BLOCK GASKET
G792 NITRILE - BLACK
G792BL NON-STICK - BLUE

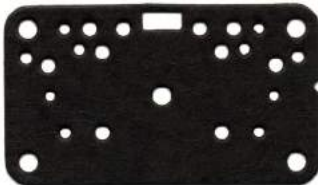

METERING BLOCK GASKET
G851 NITRILE - BLACK
G851BL NON-STICK - BLUE

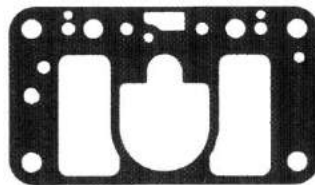

METERING BLOCK GASKET
G1047 NITRILE - BLACK
G1047BL NON-STICK - BLUE

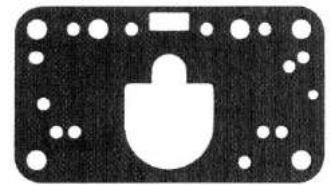

METERING BLOCK GASKET
G1057 NITRILE - BLACK
G1057BL NON-STICK - BLUE

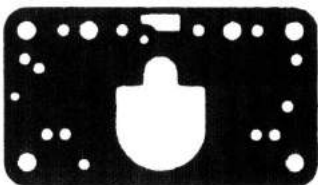

METERING BLOCK GASKET
G1062 NITRILE - BLACK
G1062BL NON-STICK - BLUE

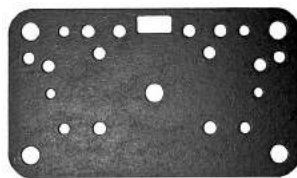

METERING BLOCK GASKET
G1070 NITRILE - BLACK
G1070BL NON-STICK - BLUE

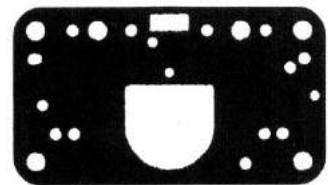

METERING BLOCK GASKET
G1156 NITRILE - BLACK
G1156BL NON-STICK - BLUE

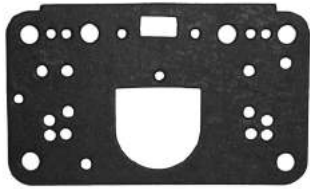

METERING BLOCK GASKET
G1392 NITRILE - BLACK
G1392BL NON-STICK - BLUE

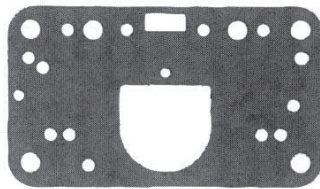

METERING BLOCK GASKET
G1394 NITRILE - BLACK
G1394BL NON-STICK - BLUE

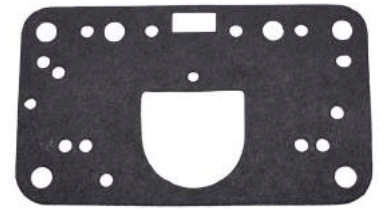

METERING BLOCK GASKET
G1806 NITRILE - BLACK



METERING BLOCK GASKET
G1934 NITRILE - BLACK

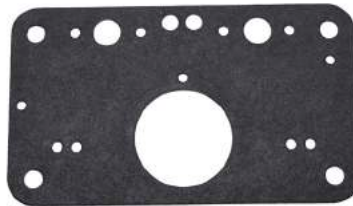

METERING BLOCK GASKET
G2020 NITRILE - BLACK
G2020BL NON-STICK - BLUE

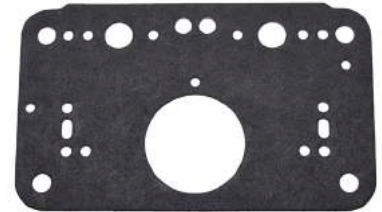

METERING BLOCK GASKET
G2021 NITRILE - BLACK
G2021BL NON-STICK - BLUE

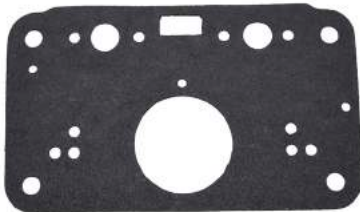

METERING BLOCK GASKET
G2022 NITRILE - BLACK
G2022BL NON-STICK - BLUE

HOLLEY® GASKETS - THROTTLE BODY

FUEL INJECTION • OXYGEN SENSORS • BUNGS & PLUGS • ENGINE MANAGEMENT

BORE: 1-11/16"

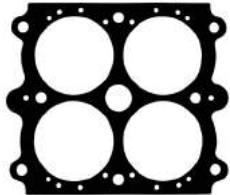

THROTTLE BODY GASKET

G694 STANDARD MATERIAL - BLACK
G694BL NON-STICK - BLUE

BORE: 1-3/4"

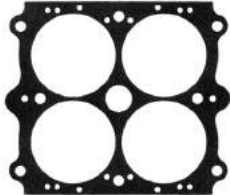

THROTTLE BODY GASKET

G739 STANDARD MATERIAL - BLACK
G739BL NON-STICK - BLUE

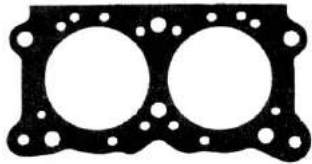

THROTTLE BODY GASKET

G774 STANDARD MATERIAL - BLACK
G774BL NON-STICK - BLUE
MODEL 2300

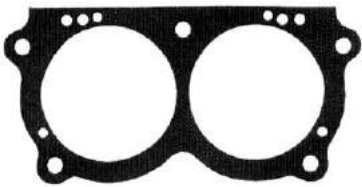

THROTTLE BODY GASKET

G775 STANDARD MATERIAL - BLACK
MODEL 2300

BORE: 1-7/16"

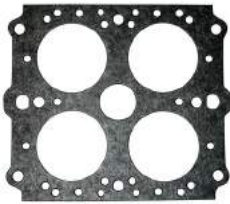

THROTTLE BODY GASKET

G843 STANDARD MATERIAL - BLACK
G843BL NON-STICK - BLUE

BORE: 1-9/16"



THROTTLE BODY GASKET

G844 STANDARD MATERIAL - BLACK
G844BL NON-STICK - BLUE

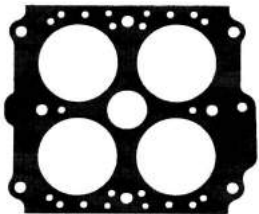

THROTTLE BODY GASKET

G905 STANDARD MATERIAL - BLACK

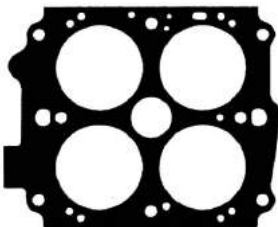

THROTTLE BODY GASKET

G1034 STANDARD MATERIAL - BLACK

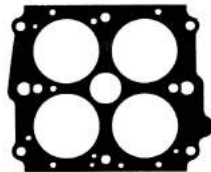

THROTTLE BODY GASKET

G1048 STANDARD MATERIAL - BLACK
G1048BL NON-STICK - BLUE
MODEL 4180



THROTTLE BODY GASKET

G1146 STANDARD MATERIAL - BLACK
G1146BL NON-STICK - BLUE
MODEL 4165

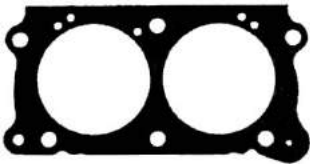

THROTTLE BODY GASKET

G1208 STANDARD MATERIAL - BLACK
G1208BL NON-STICK - BLUE
MODEL 4412

BORE: 1-9/16"

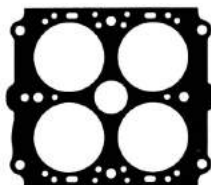

THROTTLE BODY GASKET

G1364 STANDARD MATERIAL - BLACK
G1364BL NON-STICK - BLUE

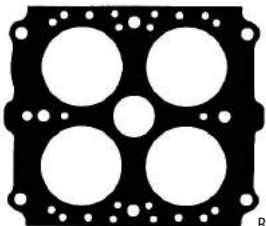

BORE: 1-7/16"

THROTTLE BODY GASKET

G1861 STANDARD MATERIAL - BLACK
G1861BL NON-STICK - BLUE

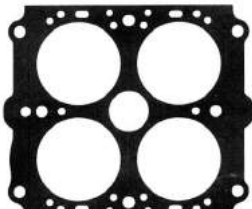

BORE: 1-9/16"

THROTTLE BODY GASKET

G1862 STANDARD MATERIAL - BLACK
G1862BL NON-STICK - BLUE

QUALITY • COVERAGE • SUPPORT



HIGH PERFORMANCE PRODUCTS • CARBURETION • CARBURETOR REPAIR KITS



HP-MAIN BODY
85-713 MODEL 950 **85-731** MODEL 750
85-714 MODEL 1000 **85-734** MODEL 650



HP-MAIN BODY
85-725 DOMINATOR 1050
85-726 DOMINATOR 1150



MAIN BODY
85-699
MODEL 4777



MAIN BODY
85-701
MODEL 7448



MAIN BODY
85-704
MODEL 3310



MAIN BODY
85-707
MODEL 4779



MAIN BODY
85-720
MODEL 4412



MAIN BODY
85-722
MODEL 4779

HOLLEY® METERING BLOCKS & COMPONENTS

FUEL INJECTION • OXYGEN SENSORS • BUNGS & PLUGS • ENGINE MANAGEMENT



**4150 HP PRIMARY & SECONDARY
BARE MACHINED METERING BLOCK**
85-470



4500 BARE MACHINED METERING BLOCK
85-546



1850 PRIMARY METERING BLOCK
85-678



4779 BARE MACHINED METERING BLOCK
85-683



3310 PRIMARY METERING BLOCK
85-688



7448 BARE ASSEMBLY METERING BLOCK
85-692



**4412 BARE MACHINED METERING BLOCK
WITH PLUGS**
85-708



4412 BARE ASSEMBLY METERING BLOCK
85-727



AIR BLEED RESTRICTOR
85-608



ALUMINUM RIVET PLUG
0-106



CHOKE PULLDOWN ADJUSTMENT PLUG
0-121



DRIVE SCREW (OE Style)
80-228



EMULSION TUBE
17-196



FUEL BOWL VENT BAFFLE
85-635



IDLE CHANNEL RESTRICTOR
85-607



IDLE MIXTURE SCREW
16-27
8-32 X .927"



IDLE MIXTURE SCREW (OE Style)
16-173
8-32 X .870"



IDLE NEEDLE CONCEALMENT PLUG
0-122



IDLE SCREW WASHER (CORK)
G283



4500 DOMINATOR IDLE WELL TUBE
17-165



4500 HP IDLE WELL TUBE
17-195



LEAD BALL PLUG
83-1



METERING BLOCK PLUG
0-137



METERING BODY BENT BAFFLE
85-626



METERING PLATE BACK-UP PLATE
85-599























**SECONDARY METERING PLATE SCREW
(OE Style)**
80-235
8-32 X .536"





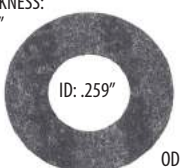









STEEL TUBE
17-168

QUALITY • COVERAGE • SUPPORT



| | | | | |
|--|---|---|---|--|
|  <p>NEEDLE & SEAT ADJUSTING NUT 85-338</p> <hr/> <p>THICKNESS: .021"</p>  <p>ID: .385" OD: .621"</p> <p>NEEDLE & SEAT ADJUSTING NUT WASHER G1360</p> |  <p>ORIFICE: .110"</p> <p>NEEDLE & SEAT ASSEMBLY 31-596</p> |  <p>ORIFICE: .097"</p> <p>NEEDLE & SEAT ASSEMBLY 31-597</p> |  <p>ORIFICE: .110"</p> <p>NEEDLE & SEAT ASSEMBLY VITRON NEEDLE 31-689</p> |  <p>ORIFICE: .097"</p> <p>NEEDLE & SEAT ASSEMBLY VITRON NEEDLE 31-690</p> |
|  <p>ORIFICE: .120"</p> <p>NEEDLE & SEAT ASSEMBLY VITRON NEEDLE 31-738</p> |  <p>ORIFICE: .110"</p> <p>NEEDLE & SEAT ASSEMBLY STAINLESS STEEL NEEDLE 31-761</p> |  <p>ORIFICE: .097"</p> <p>NEEDLE & SEAT ASSEMBLY STAINLESS STEEL NEEDLE 31-762</p> |  <p>ORIFICE: .120"</p> <p>NEEDLE & SEAT ASSEMBLY STAINLESS STEEL NEEDLE 31-763</p> |  <p>ORIFICE: .130"</p> <p>NEEDLE & SEAT ASSEMBLY VITRON NEEDLE 31-773</p> |
|  <p>ORIFICE: .130"</p> <p>NEEDLE & SEAT ASSEMBLY STAINLESS STEEL NEEDLE 31-736 ALCOHOL</p> |  <p>ORIFICE: .150"</p> <p>NEEDLE & SEAT ASSEMBLY STAINLESS STEEL NEEDLE 31-737 ALCOHOL</p> |  <p>ORIFICE: .101"</p> <p>NEEDLE & SEAT ASSEMBLY 31-649 EXTRA THREADS</p> |  <p>ORIFICE: .120"</p> <p>NEEDLE & SEAT ASSEMBLY 31-676 EXTRA THREADS</p> |  <p>ORIFICE: .101"</p> <p>NEEDLE & SEAT ASSEMBLY 31-650 EXTRA & OVERSIZED THREADS</p> |
|  <p>ORIFICE: .097"</p> <p>NEEDLE & SEAT ASSEMBLY 31-764 SPRING LOADED, OFF ROAD</p> | <p>THICKNESS: .021"</p>  <p>ID: .259" OD: .535"</p> <p>NEEDLE & SEAT LOCK SCREW WASHER G1355</p> |  <p>NEEDLE & SEAT SCREW 85-337</p> | <p>THICKNESS: .021"</p>  <p>ID: .385" OD: .621"</p> <p>NEEDLE & SEAT WASHER, NYLON G1718</p> | <p>THICKNESS: .021" ID: .259" OD: .535"</p>  <p>NEEDLE & SEAT WASHER, NYLON G1719</p> <hr/> <p>THICKNESS: .070" ID: .176" OD: .316"</p>  <p>SECONDARY TUBE O-RING G273</p> |

| | | | | | |
|---|--|---|---|--|---|
|  <p>CHOKE CONTROL BRACKET CLAMP 85-628</p> |  <p>CHOKE CONTROL WIRE BRACKET SCREW (OE Style) 80-45 8-32 x 1/2"</p> |  <p>CHOKE HOUSING GASKET G282</p> |  <p>CHOKE WIRE BRACKET 85-629</p> |  <p>DIAPHRAGM COVER SCREW (OE Style) 80-239 8-32 X 9/16"</p> |  <p>DIAPHRAGM HOUSING TO BODY SCREW (OE Style) 80-242 8-32 X 1"</p> |
|  <p>"E" CLIP RETAINER 62-45</p> |  <p>8/32" NUT 81-2</p> |  <p>PLUNGER WASHER 85-23</p> |  <p>SECONDARY PUMP CAM LEVEL SCREW (OE Style) 80-224 10-32 x 5/16"</p> |  <p>SECONDARY DIAPHRAGM COVER RETAINER O-RING G1860</p> |  <p>SECONDARY DIAPHRAGM LEVER 85-642</p> |
|  <p>GOVERNOR DIAPHRAGM ASSEMBLY 64-328</p> | <p>LENGTH: 1-7/8"</p>  <p>SECONDARY DIAPHRAGM ASSEMBLY 64-170</p> | <p>LENGTH: 2-1/16"</p>  <p>SECONDARY DIAPHRAGM ASSEMBLY 64-197</p> | <p>LENGTH: 1-31/32"</p>  <p>SECONDARY DIAPHRAGM ASSEMBLY 64-236</p> |  <p>SECONDARY DIAPHRAGM ASSEMBLY 64-238</p> | |
|  <p>SECONDARY DIAPHRAGM ASSEMBLY, TRI-POWER 64-487</p> |  <p>SECONDARY DIAPHRAGM COVER 85-645</p> |  <p>SECONDARY DIAPHRAGM COVER 85-650</p> |  <p>SECONDARY DIAPHRAGM SPRING 66-152 LIGHTEST LOAD, COLOR: WHITE</p> | <p>LENGTH: SHORT</p>  <p>SECONDARY DIAPHRAGM SPRING 66-153 LIGHTER LOAD, COLOR: YELLOW</p> | |
| <p>LENGTH: LONG</p>  <p>SECONDARY DIAPHRAGM SPRING 66-154 LIGHT LOAD, COLOR: YELLOW</p> |  <p>SECONDARY DIAPHRAGM SPRING 66-155 MEDIUM LIGHT LOAD, COLOR: PURPLE</p> |  <p>SECONDARY DIAPHRAGM SPRING 66-156 MEDIUM LOAD, COLOR: PLAIN</p> |  <p>SECONDARY DIAPHRAGM SPRING 66-157 MEDIUM HEAVY LOAD, COLOR: BROWN</p> |  <p>SECONDARY DIAPHRAGM SPRING 66-158 HEAVY LOAD, COLOR: BLACK</p> | |

| | | | |
|--|--|--|--|
|  <p>"E" CLIP RETAINER 62-47</p> |  <p>CHOKE DIAPHRAGM LINK R144 MODEL 4165</p> |  <p>CHOKE ROD R145 MODEL 4150</p> |  <p>CHOKE ROD R147 MODEL 4165, 4175</p> |
|  <p>CHOKE ROD, CONVERTS MECHANICAL TO ELECTRIC CHOKE R152</p> |  <p>CHOKE ROD, ELECTRIC R53 MODEL 2300, 4160</p> |  <p>CONNECTING ROD, MECHANICAL SECONDARY 50-54 MODEL 4150</p> |  <p>CONNECTING ROD, MECHANICAL SECONDARY R149 MODEL 4011</p> |
|  <p>CONNECTING ROD, SECONDARY R151</p> |  <p>CONNECTING ROD, VACUUM SECONDARY 50-30</p> |  <p>CONNECTING ROD, VACUUM SECONDARY R142 MODEL 4150</p> |  <p>CONNECTING ROD, VACUUM SECONDARY R148 MODEL 4175</p> |
|  <p>COTTER PIN 32-11</p> |  <p>DOMINATOR THROTTLE LEVER CONNECTING LINK R143</p> |  <p>PUMP ARM STUD 22-162</p> | |
|  <p>PUMP ARM STUD, EARLY STYLE 22-173</p> |  <p>STAINLESS STEEL WASHER 82-15</p> |  <p>THROTTLE SHAFT BUSHING 22-164</p> | |

HOLLEY®

THROTTLE SHAFT & COMPONENTS

FUEL INJECTION • OXYGEN SENSORS • BUNGS & PLUGS • ENGINE MANAGEMENT



FAST IDLE CAM LEVER
85-615



FAST IDLE CAM LEVER SPRING
66-181



FAST IDLE CAM PICK UP LEVER
85-616



LINKAGE GUIDE BUSHING
85-609
MODEL 4500



LINKAGE PIVOT SCREW
80-233
1/4" -10 x 3-1/4"



PRIMARY THROTTLE LEVER 1:1
85-603
MODEL 4500



PRIMARY THROTTLE LEVER PROGRESSIVE
85-604
MODEL 4500



PRIMARY THROTTLE LEVER SOFT PROGRESSIVE
85-605
MODEL 4500



PRIMARY THROTTLE SHAFT
20-94
MODEL 4150



PRIMARY THROTTLE SHAFT
20-97
MODEL 3300, WITH FORD KICK DOWN LEVER



PRIMARY THROTTLE SHAFT
20-98
MODEL 1850, WITH FORD KICK DOWN LEVER



PRIMARY THROTTLE SHAFT SPRING
66-182
MODEL 4500



PRIMARY THROTTLE SHAFT SPRING
66-183
MODEL 4500



SECONDARY PUMP CAM LEVER SCREW (OE Style)
80-224
10-32 x 5/16"



SECONDARY THROTTLE LEVER
85-643
MODEL 4500



SECONDARY THROTTLE SHAFT
20-93
MODEL 4150



SECONDARY THROTTLE SHAFT SPRING
66-173



SHAFT BUSHING
22-134



STAINLESS STEEL WASHER
82-16
MODEL 4500



THROTTLE LEVER
85-644
MODEL 4500



THROTTLE LEVER SCREW
80-232
10-32 x 7/8"

THICKNESS:
.015"



THROTTLE SHAFT BUSHING - TEFLON
22-163



THROTTLE SHAFT BUSHING - TEFLON
22-31

THICKNESS:
.015"



THROTTLE SHAFT BUSHING - TEFLON
G1127

THICKNESS:
.022"



THROTTLE SHAFT BUSHING - TEFLON
G1128

THICKNESS:
.022"



THROTTLE SHAFT BUSHING - TEFLON
G540

QUALITY • COVERAGE • SUPPORT



HIGH PERFORMANCE PRODUCTS • CARBURETION • CARBURETOR REPAIR KITS

| | | | | |
|---|--|---|---|--|
|  <p>LENGTH: 1-5/32"</p> <p>OD: 5/16"</p> <p>BOWL VENT TUBE 17-72</p> |  <p>LENGTH: 1-5/16"</p> <p>OD: 5/16"</p> <p>BOWL VENT TUBE 17-167</p> |  <p>LENGTH: 1-3/8"</p> <p>OD: 5/16"</p> <p>BOWL VENT TUBE, BRASS 17-43</p> |  <p>BOWL VENT TUBE, TRUCK AVENGER 85-741</p> |  <p>OD: 11/16"</p> <p>CHOKE PISTON PLUG 85-54</p> |
|  <p>OD: 1/4"</p> <p>CHOKE PULLDOWN ADJUSTMENT PLUG 0-121</p> |  <p>THICKNESS: .125"</p> <p>CHOKE ROD HOLE BLOCK-OFF PLATE 85-660</p> |  <p>CHOKE SHAFT 85-760</p> |  <p>OD: .57"</p> <p>DISCHARGE TUBE 17-198</p> |  <p>GOVERNOR AIR JET 120-8 10-32 THREAD</p> |
|  <p>OD: 1/4"</p> <p>IDLE NEEDLE CONCEALMENT PLUG 0-122</p> |  <p>OD: 3/16"</p> <p>IDLE PLUG, ALUMINUM 0-112</p> |  <p>"J" TUBE MARINE APPLICATION 85-453</p> |  <p>DOMINATOR "J" TUBE MARINE APPLICATION 85-732</p> |  <p>SIZE: .192"</p> <p>METERING BLOCK PLUG 0-137</p> |
|  <p>LENGTH: 7/8"</p> <p>OD: 1/8"</p> <p>MID RANGE TUBE 17-164</p> |  <p>PASSAGE TUBE, BRASS 17-59</p> |  <p>PLASTIC THROTTLE LEVER GROMMET BUSHING 22-17</p> |  <p>SIZE: .132"</p> <p>RIVET PLUG, ALUMINUM 0-106</p> | |
|  <p>OD: 3/8"</p> <p>THROTTLE SHAFT CUP 0-126</p> |  <p>OD: 1/4"</p> <p>THROTTLE SHAFT PLUG 85-206</p> |  <p>LENGTH: 1-11/16"</p> <p>OD: 5/16"</p> <p>VENT TUBE 17-7</p> | | |

FUEL INJECTION • OXYGEN SENSORS • BUNGS & PLUGS • ENGINE MANAGEMENT

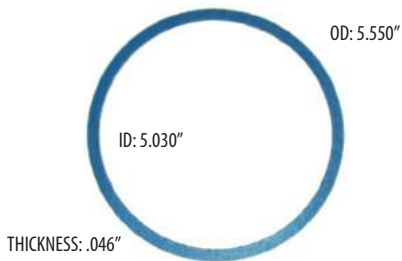

AIR CLEANER GASKET
G702 BLACK STANDARD
G702BL BLUE NON-STICK
G702RD RED NON-STICK

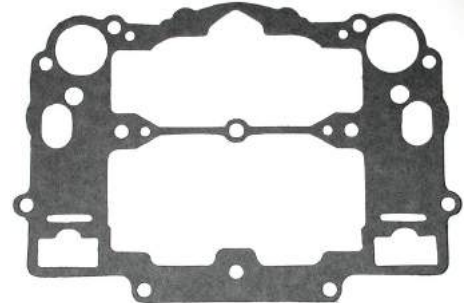

BOWL COVER GASKET
G1325



BOWL VENT VALVE
G679



BRASS FLOAT
100-94



BRASS PUMP CHECK
17-67



CHECK BALL
90-146



CHOKE COVER CAP
40-4



CHOKE COVER GASKET
G1115



CHOKE COVER RETAINER
85-203



CHOKE THERMOSTAT
102-1081



CHOKE THERMOSTAT SPRING
66-32



FLANGE GASKET
G1268

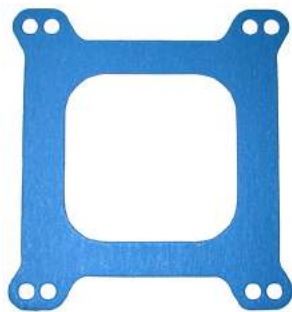

FLANGE GASKET
G1407 BLACK STANDARD
G1407BL BLUE NON-STICK



FLANGE GASKET
G1646



FLUORELASTOMER PUMP ASSEMBLY
64-464



FLOAT PIN
32-27



FLOAT PIN
32-32



FLUORELASTOMER PUMP PLUNGER CUP
64-332

HIGH PERFORMANCE PRODUCTS • CARBURETION • CARBURETOR REPAIR KITS

WPA-1479 METERING ROD JET KIT AFB #1405



| PART # | DESCRIPTION | QTY | PART # | DESCRIPTION | QTY |
|------------|--------------|-----|-----------|----------------------------|-----|
| 120-27-089 | METERING JET | 2 | 130-7352 | METERING ROD | 2 |
| 120-27-092 | METERING JET | 2 | 130-7547 | METERING ROD | 2 |
| 120-27-098 | METERING JET | 2 | 62-56P-10 | BAGGED COMPONENTS- 10 PACK | 1 |
| 120-27-101 | METERING JET | 2 | 66-128 | SPRING | 2 |
| 120-27-104 | METERING JET | 2 | 66-184 | SPRING, METERING BLUE | 2 |
| 130-6842 | METERING ROD | 2 | 66-185 | SPRING, METERING YELLOW | 2 |
| 130-6852 | METERING ROD | 2 | 66-186 | SPRING, METERING ORANGE | 2 |
| 130-7052 | METERING ROD | 2 | 66-187 | SPRING, METERING PINK | 2 |
| 130-7347 | METERING ROD | 2 | 66-188 | SPRING, METERING SILVER | 2 |

WPA-1480 METERING ROD JET KIT AFB #1407, 1410, 1412 & 1413



| PART # | DESCRIPTION | QTY | PART # | DESCRIPTION | QTY |
|------------|--------------|-----|-----------|----------------------------|-----|
| 120-27-101 | METERING JET | 2 | 130-7347 | METERING ROD | 2 |
| 120-27-104 | METERING JET | 2 | 130-7352 | METERING ROD | 2 |
| 120-27-107 | METERING JET | 2 | 62-56P-10 | BAGGED COMPONENTS- 10 PACK | 1 |
| 120-27-110 | METERING JET | 2 | 66-128 | SPRING | 2 |
| 120-27-113 | METERING JET | 2 | 66-184 | SPRING, METERING BLUE | 2 |
| 120-27-116 | METERING JET | 2 | 66-185 | SPRING, METERING YELLOW | 2 |
| 130-6537 | METERING ROD | 2 | 66-186 | SPRING, METERING ORANGE | 2 |
| 130-6547 | METERING ROD | 2 | 66-187 | SPRING, METERING PINK | 2 |
| 130-6847 | METERING ROD | 2 | 66-188 | SPRING, METERING SILVER | 2 |

WPA-1486 METERING ROD JET KIT AFB #1403 & 1404























| PART # | DESCRIPTION | QTY | PART # | DESCRIPTION | QTY |
|------------|--------------|-----|-----------|----------------------------|-----|
| 120-27-083 | METERING JET | 2 | 130-6852 | METERING ROD | 2 |
| 120-27-089 | METERING JET | 2 | 62-56P-10 | BAGGED COMPONENTS- 10 PACK | 1 |
| 120-27-092 | METERING JET | 2 | 66-128 | SPRING | 2 |
| 120-27-095 | METERING JET | 2 | 66-184 | SPRING, METERING BLUE | 2 |
| 120-27-098 | METERING JET | 2 | 66-185 | SPRING, METERING YELLOW | 2 |
| 130-5749 | METERING ROD | 2 | 66-186 | SPRING, METERING ORANGE | 2 |
| 130-6252 | METERING ROD | 2 | 66-187 | SPRING, METERING PINK | 2 |
| 130-6347 | METERING ROD | 2 | 66-188 | SPRING, METERING SILVER | 2 |
| 130-6755 | METERING ROD | 2 | | | |

WPA-1487 METERING ROD JET KIT AFB #1406



| PART # | DESCRIPTION | QTY | PART # | DESCRIPTION | QTY |
|------------|----------------------------|-----|--------|-------------------------|-----|
| 120-27-095 | METERING JET | 2 | 66-128 | SPRING | 2 |
| 120-27-098 | METERING JET | 2 | 66-184 | SPRING, METERING BLUE | 2 |
| 120-27-101 | METERING JET | 2 | 66-185 | SPRING, METERING YELLOW | 2 |
| 130-7037 | METERING ROD | 2 | 66-186 | SPRING, METERING ORANGE | 2 |
| 130-7342 | METERING ROD | 2 | 66-187 | SPRING, METERING PINK | 2 |
| 130-7347 | METERING ROD | 2 | 66-188 | SPRING, METERING SILVER | 2 |
| 62-56P-10 | BAGGED COMPONENTS- 10 PACK | 1 | | | |

FUEL INJECTION • OXYGEN SENSORS • BUNGS & PLUGS • ENGINE MANAGEMENT

| | | | | |
|---|--|---|--|--|
|  <p>FUEL FILTER <u>30-74</u></p> |  <p>FUEL FITTING BANJO ASSEMBLY <u>90-177</u></p> |  <p>OD: .883" ID: .615" THICKNESS: .026"</p> <p>FUEL INLET FITTING WASHER <u>G1207</u></p> |  <p>OVERALL LENGTH: 2.570" ID: 13/16"</p> <p>HIGH PERFORMANCE FLUORELASTOMER PUMP ASSEMBLY W/HEAVY DUTY SPRING <u>64-488</u></p> | |
|  <p>HIGH SPEED PASSAGE PLUG <u>0-50</u></p> |  <p>OD: .320" ID: .215" THICKNESS: .062"</p> <p>HOT AIR PASSAGE GASKET - Rubber <u>G1266</u></p> |  <p>OVERALL LENGTH: .875" ID: .240" WIRE DIAMETER: .040"</p> <p>IDLE ADJUSTMENT SCREW SPRING <u>66-58</u></p> | | |
|  <p>IDLE SCREW <u>16-29</u> 10-32 X 1.452"</p> |  <p>IDLE SCREW <u>16-59</u> 10-32 X 1.920"</p> |  <p>IDLE SCREW <u>16-168</u> 10-32 X 1.685"</p> |  <p>PUMP DISCHARGE BALL SPRING <u>66-146</u></p> |  <p>PUMP JET HOUSING GASKET <u>G379</u></p> |
|  <p>OVERALL LENGTH: 1.655" ID: .420" WIRE DIAMETER: .030"</p> <p>PUMP PLUNER SPRING <u>66-129</u></p> |  <p>PUMP SHAFT SEAL <u>64-430</u></p> |  <p>ROD RETAINER <u>62-56</u></p> | | |
|  <p>OVERALL LENGTH: 1.110" ID: .182" WIRE DIAMETER: .017"</p> <p>SPRING - BLUE <u>66-184</u></p> |  <p>OVERALL LENGTH: 1.280" ID: .180" WIRE DIAMETER: .015"</p> <p>SPRING - YELLOW <u>66-185</u></p> |  <p>OVERALL LENGTH: 1.365" ID: .175" WIRE DIAMETER: .018"</p> <p>SPRING - ORANGE <u>66-186</u></p> |  <p>OVERALL LENGTH: 1.585" ID: .170" WIRE DIAMETER: .017"</p> <p>SPRING - PINK <u>66-187</u></p> |  <p>OVERALL LENGTH: 1.310" ID: .175" WIRE DIAMETER: .018"</p> <p>SPRING - SILVER <u>66-188</u></p> |

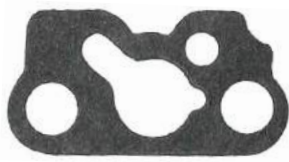

VENTURI CLUSTER GASKET
G349



VENTURI CLUSTER GASKET
G633

31-512 VITON NEEDLE & SEAT ASSEMBLY



ORIFICE: .110"

VITON NEEDLE & SEAT ASSEMBLY



OD: .416"

THICKNESS: .031"

ID: .300"

NEEDLE & SEAT GASKET - Fiber



NEEDLE

31-730 VITON NEEDLE & SEAT ASSEMBLY



ORIFICE: .110"

VITON NEEDLE & SEAT ASSEMBLY



OD: .421"

THICKNESS: .026"

ID: .319"

NEEDLE & SEAT GASKET - Aluminum & Rubber



NEEDLE



NEEDLE



PIN



SPRING

31-733 VITON NEEDLE & SEAT ASSEMBLY



ORIFICE: .090"

VITON NEEDLE & SEAT ASSEMBLY



OD: .426"

THICKNESS: .025"

ID: .300"

NEEDLE & SEAT GASKET - Aluminum & Rubber



FILTER SCREEN



NEEDLE

CARBURETOR REPAIR KITS

CARTER™ APPLICATION & BUYER'S GUIDE

FUEL INJECTION • OXYGEN SENSORS • BUNGS & PLUGS • ENGINE MANAGEMENT

| WALKER # | ENGINE/MODEL | MFG CODE | MODEL | NEEDLE & SEAT | ACC. PUMP | POWER VALVE | FLANGE GASKET |
|----------|-----------------------------|----------|-------|---------------------|-----------|-------------|---------------|
| 15881A | 400, 500, 600, 625, 750 CFM | C-4 | AFB | 31-730 (2 REQUIRED) | 64-257 | — | G741 |
| 159016 | 500, 600, 750, 800 CFM | C-4 | AFB | 31-733 (2 REQUIRED) | 64-332 | — | G1407 |

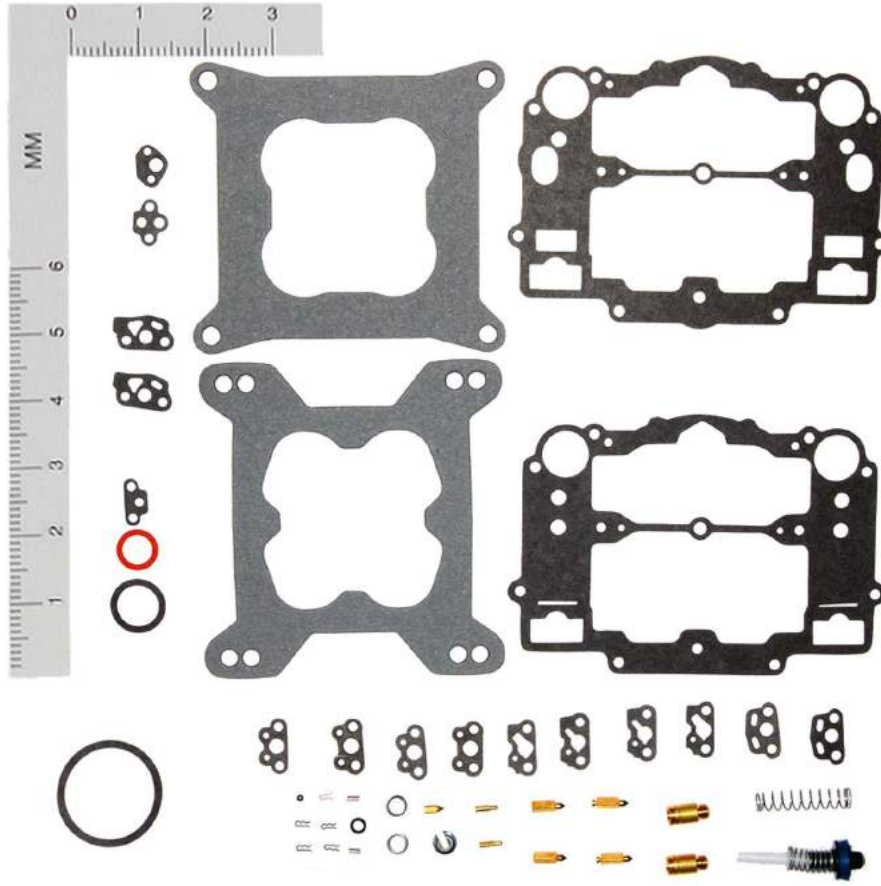

CARTER - SQUARE FLANGE/PERFORMANCE EQUIPPED
15881A

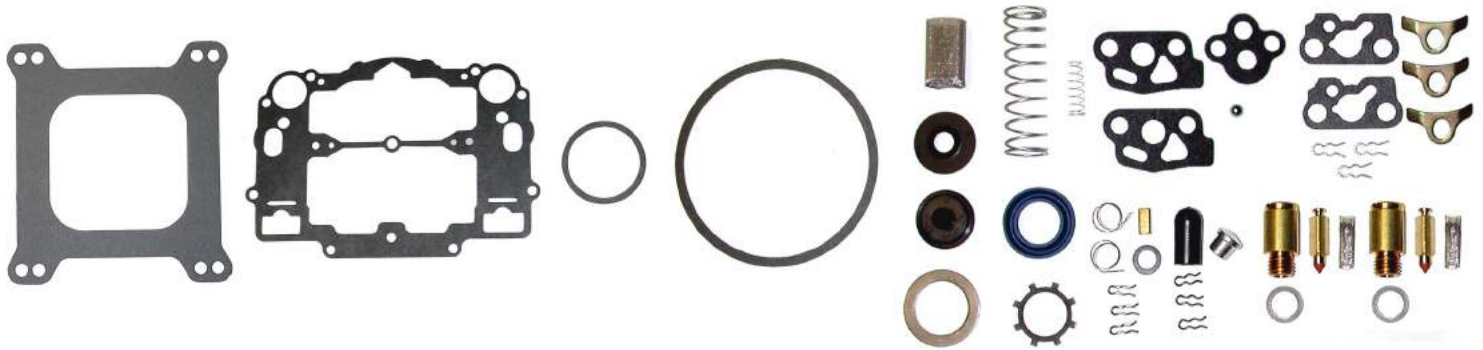

CARTER - SQUARE FLANGE/PERFORMANCE EQUIPPED
159016

QUALITY • COVERAGE • SUPPORT





CARBURETOR REPAIR KITS

HOLLEY® APPLICATION & BUYER'S GUIDE

HIGH PERFORMANCE PRODUCTS • CARBURETION • CARBURETOR REPAIR KITS

| WALKER # | ENGINE/MODEL | MFG CODE | MODEL | NEEDLE & SEAT | ACC. PUMP | POWER VALVE | FLANGE GASKET |
|----------|--|----------|-------|---------------------|----------------|-------------|---------------|
| 15456B | 600, 650, 700, 750, 800, 812, 830, 850 CFM | H-4 | 4150 | 31-689 (2 REQUIRED) | 64-326, 64-288 | 70-165 | G669 |
| 15879 | 500 CFM | H-2 | 2300 | 31-676 | 64-288 | 70-155 | G765 |
| 151095 | 650, 750 CFM | H-4 | 4010 | 31-689 (2 REQUIRED) | 64-326 | 70-165 | G745 |
| 151096 | 650, 800 CFM | H-4 | 4011 | 31-689 (2 REQUIRED) | 64-326 | 70-165 | G963 |
| 159018 | 750, 1050, 1150, 1250 CFM | H-4 | 4500 | 31-689 (2 REQUIRED) | 64-288 | | G954 |

MARINE APPLICATION

| | | | | | | | |
|--------|---------|-----|------|---------------------|--------|--------|------|
| 159017 | 600 CFM | H-4 | 4160 | 31-595 (2 REQUIRED) | 64-197 | 70-150 | G676 |
|--------|---------|-----|------|---------------------|--------|--------|------|

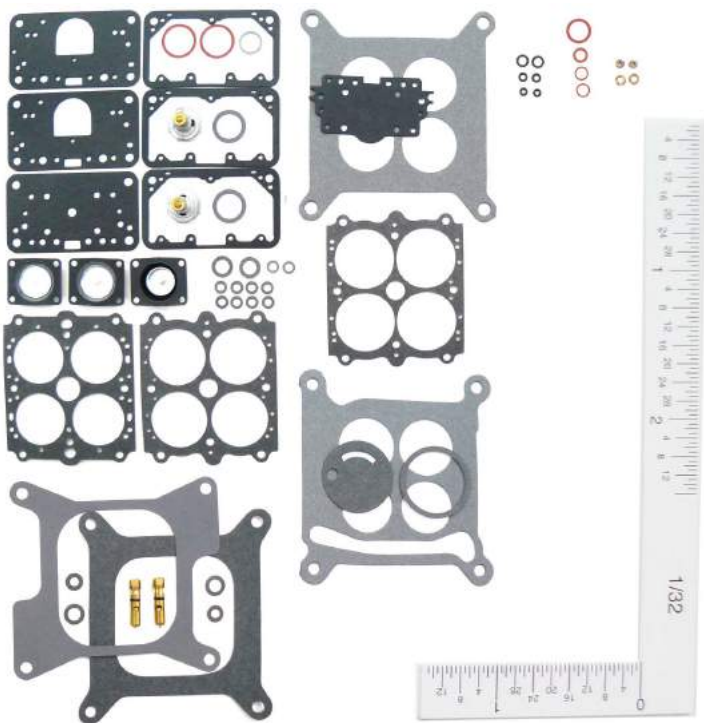

HOLLEY
15456B

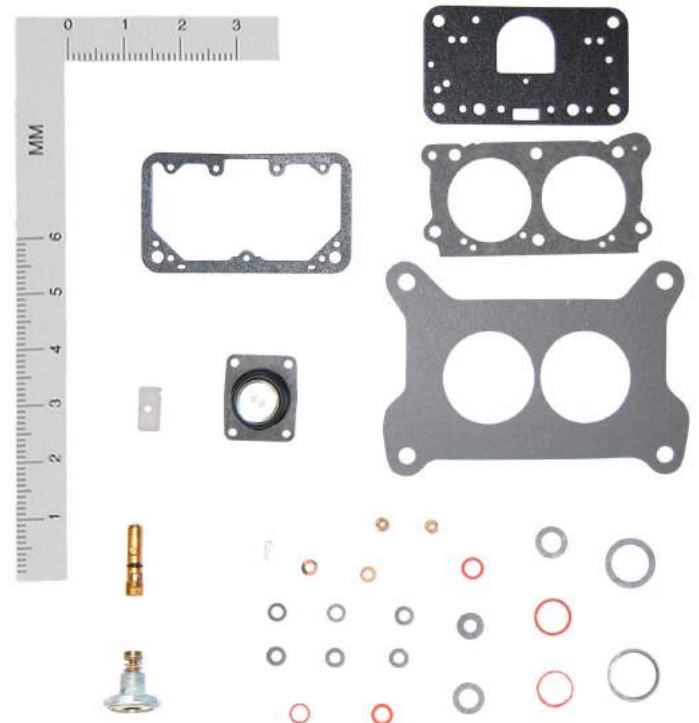

HOLLEY
15879

CARBURETOR REPAIR KITS

HOLLEY® APPLICATION & BUYER'S GUIDE

FUEL INJECTION • OXYGEN SENSORS • BUNGS & PLUGS • ENGINE MANAGEMENT



HOLLEY
151095

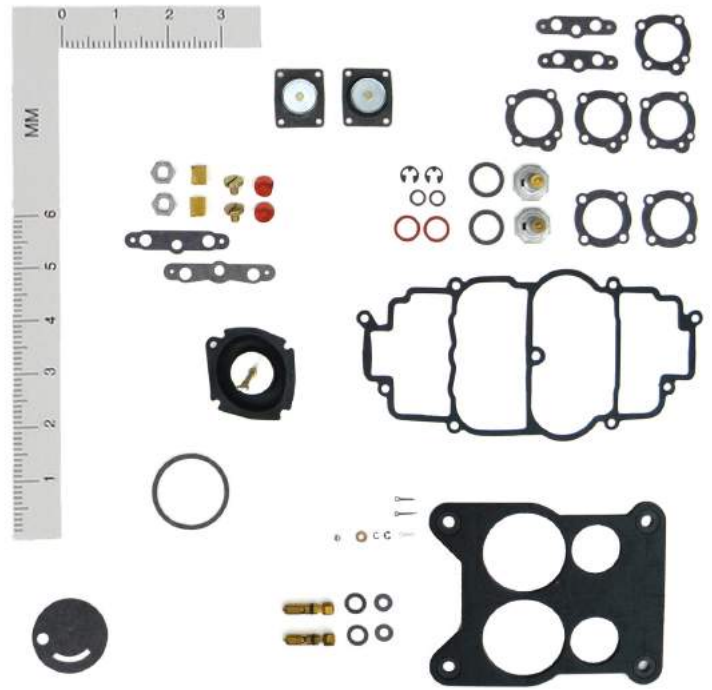

HOLLEY
151096

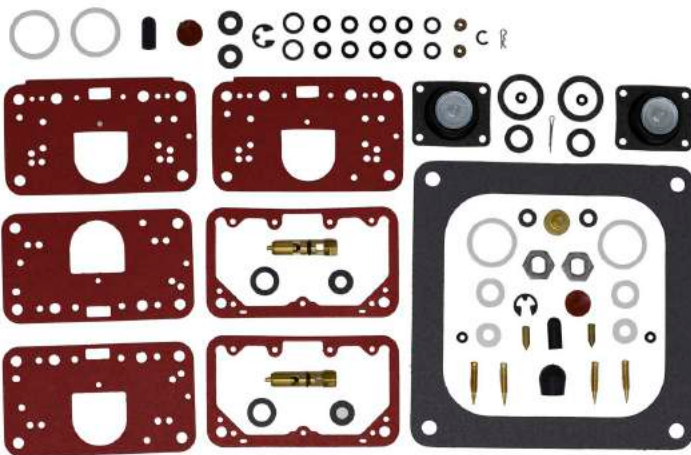

HOLLEY
159018

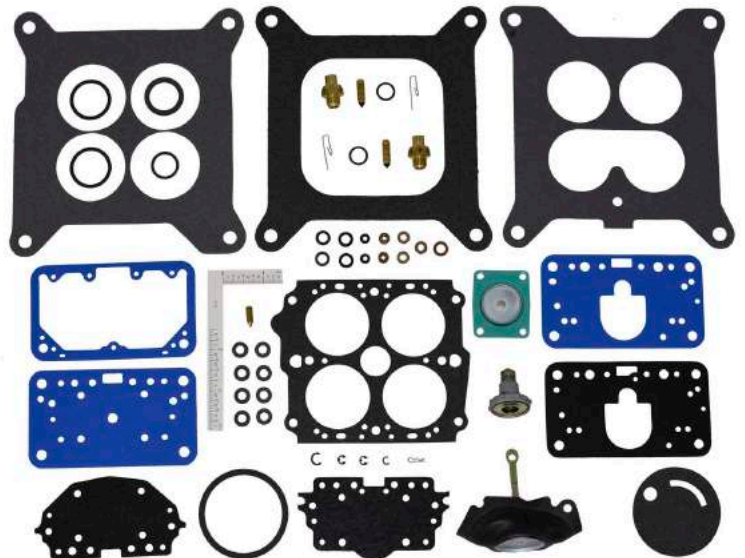

HOLLEY - MARINE APPLICATION
159017

QUALITY • COVERAGE • SUPPORT



HIGH PERFORMANCE PRODUCTS • CARBURETION • CARBURETOR REPAIR KITS

| WALKER # | ENGINE/MODEL | MFG CODE | MODEL | NEEDLE & SEAT | ACC. PUMP | POWER VALVE | FLANGE GASKET |
|----------|---------------|----------|-------|---------------|-----------|-------------|---------------|
| 159055 | 750, 795, 850 | R-4 | QUAD | 31-546 | 64-344 | — | G1697 |
| 159056 | 750, 795, 850 | R-4 | QUAD | 31-678 | 64-344 | — | G581, G1697 |



ROCHESTER
159055



ROCHESTER
159056

CONNECTORS

1 & 2 WIRE

FUEL INJECTION • OXYGEN SENSORS • BUNGS & PLUGS • ENGINE MANAGEMENT



1-WIRE CONNECTOR
270-1000



1-WIRE CONNECTOR
270-1001



1-WIRE CONNECTOR
270-1043



1-WIRE CONNECTOR
270-1071



2-WIRE CONNECTOR
210-1501



2-WIRE CONNECTOR
211-1500



2-WIRE CONNECTOR
270-1033



2-WIRE CONNECTOR
270-1034



2-WIRE CONNECTOR
270-1049



2-WIRE CONNECTOR
270-1050



2-WIRE CONNECTOR
270-1051



2-WIRE CONNECTOR
270-1052



2-WIRE CONNECTOR
270-1053



2-WIRE CONNECTOR
270-1054



2-WIRE CONNECTOR
270-1055



2-WIRE CONNECTOR
270-1056

QUALITY • COVERAGE • SUPPORT





2-WIRE CONNECTOR
270-1057



2-WIRE CONNECTOR
270-1062



2-WIRE CONNECTOR
270-1063



2-WIRE CONNECTOR
270-1092



2-WIRE CONNECTOR
270-1096



2-WIRE CONNECTOR
270-1097



2-WIRE CONNECTOR
270-1098



2-WIRE CONNECTOR
270-1099



2-WIRE CONNECTOR
270-1100



2-WIRE CONNECTOR
270-1102



2-WIRE CONNECTOR
270-1106



2-WIRE CONNECTOR
270-1112



3-WIRE CONNECTOR
270-1002



3-WIRE CONNECTOR
270-1003



3-WIRE CONNECTOR
270-1004



3-WIRE CONNECTOR
270-1006

CONNECTORS

3 WIRE

FUEL INJECTION • OXYGEN SENSORS • BUNGS & PLUGS • ENGINE MANAGEMENT



3-WIRE CONNECTOR
270-1035



3-WIRE CONNECTOR
270-1036



3-WIRE CONNECTOR
270-1038



3-WIRE CONNECTOR
270-1039



3-WIRE CONNECTOR
270-1044



3-WIRE CONNECTOR
270-1045



3-WIRE CONNECTOR
270-1046



3-WIRE CONNECTOR
270-1047



3-WIRE CONNECTOR
270-1048



3-WIRE CONNECTOR
270-1058



3-WIRE CONNECTOR
270-1059



3-WIRE CONNECTOR
270-1060



3-WIRE CONNECTOR
270-1061



3-WIRE CONNECTOR
270-1064



3-WIRE CONNECTOR
270-1065



3-WIRE CONNECTOR
270-1066

QUALITY • COVERAGE • SUPPORT



HIGH PERFORMANCE PRODUCTS • CARBURETION • CARBURETOR REPAIR KITS



3-WIRE CONNECTOR
270-1073



3-WIRE CONNECTOR
270-1076



3-WIRE CONNECTOR
270-1077



3-WIRE CONNECTOR
270-1079



3-WIRE CONNECTOR
270-1080



3-WIRE CONNECTOR
270-1081



3-WIRE CONNECTOR
270-1083



3-WIRE CONNECTOR
270-1085



3-WIRE CONNECTOR
270-1086



3-WIRE CONNECTOR
270-1088



3-WIRE CONNECTOR
270-1089



3-WIRE CONNECTOR
270-1093



3-WIRE CONNECTOR
270-1111



4-WIRE CONNECTOR
270-1007



4-WIRE CONNECTOR
270-1009



4-WIRE CONNECTOR
270-1010

CONNECTORS

4 WIRE

FUEL INJECTION • OXYGEN SENSORS • BUNGS & PLUGS • ENGINE MANAGEMENT



4-WIRE CONNECTOR
270-1012



4-WIRE CONNECTOR
270-1013



4-WIRE CONNECTOR
270-1014



4-WIRE CONNECTOR
270-1037



4-WIRE CONNECTOR
270-1040



4-WIRE CONNECTOR
270-1042



4-WIRE CONNECTOR
270-1074



4-WIRE CONNECTOR
270-1075



4-WIRE CONNECTOR
270-1082

HIGH PERFORMANCE PRODUCTS • CARBURETION • CARBURETOR REPAIR KITS

| | | | | |
|--|--|---|---|---|
|  <p>CAPTIVE INSTALL TOOL 86-4001 THREADS: 6-32</p> |  <p>CAPTIVE INSTALL TOOL 86-4003 THREADS: 10-24</p> |  <p>CAPTIVE INSTALL TOOL 86-4004 THREADS: 10-32</p> |  <p>CAPTIVE INSTALL TOOL 86-4005 THREADS: 12-24</p> |  <p>CAPTIVE INSTALL TOOL 86-4006 THREADS: 12-28</p> |
|  <p>CAPTIVE INSTALL TOOL 86-4008 THREADS: 1/4-28</p> |  <p>CAPTIVE INSTALL TOOL 86-4010 THREADS: 5/16-24</p> |  <p>CAPTIVE INSTALL TOOL 86-4011 THREADS: 3/8-16</p> |  <p>CAPTIVE INSTALL TOOL 86-4023 THREADS: M3x5</p> |  <p>CAPTIVE INSTALL TOOL 86-4031 THREADS: M10x1.25</p> |
|  <p>14mm EGTS SOCKET 88-840</p> |  <p>17mm EGTS SOCKET 88-841</p> |  <p>FILTER INSTALLATION TOOL 88-820</p> |  <p>HELICOIL 86-1001 THREADS: 6-32</p> |  <p>HELICOIL 86-1002 THREADS: 8-32</p> |
|  <p>HELICOIL 86-1003 THREADS: 10-24</p> |  <p>HELICOIL 86-1004 THREADS: 10-32</p> |  <p>HELICOIL 86-1006 THREADS: 12-28</p> |  <p>HELICOIL 86-1007 THREADS: 1/4-20</p> |  <p>HELICOIL 86-1008 THREADS: 1/4-28</p> |
|  <p>HELICOIL 86-1009 THREADS: 5/16-28</p> |  <p>HELICOIL 86-1010 THREADS: 5/16-24</p> |  <p>HELICOIL 86-1011 THREADS: 3/8-16</p> |  <p>HELICOIL 86-1012 THREADS: 3/8-24</p> |  <p>HELICOIL 86-1013 THREADS: 7/16-20</p> |
|  <p>HELICOIL 86-1014 THREADS: 7/16-24</p> |  <p>HELICOIL 86-1015 THREADS: 1/2-20</p> |  <p>HELICOIL 86-1017 THREADS: 7/8-20</p> |  <p>HELICOIL 86-1018 THREADS: 1-20</p> |  <p>HELICOIL 86-1019 THREADS: 5/16-18 x .625</p> |

FUEL INJECTION • OXYGEN SENSORS • BUNGS & PLUGS • ENGINE MANAGEMENT

| | | | | |
|--|---|--|--|--|
|  <p>HELICOIL 86-1020 THREADS: 3/8-16 x .562</p> |  <p>HELICOIL 86-1021 THREADS: 7/16-24 x .656</p> |  <p>HELICOIL 86-1023 THREADS: M3 x 5</p> |  <p>HELICOIL 86-1024 THREADS: M4 x 7</p> |  <p>HELICOIL 86-1025 THREADS: M5 x 8</p> |
|  <p>HELICOIL 86-1026 THREADS: M6 x 1</p> |  <p>HELICOIL 86-1027 THREADS: M8 x 1</p> |  <p>HELICOIL 86-1028 THREADS: M8 x 1.25</p> |  <p>HELICOIL 86-1030 THREADS: M10 x 1</p> |  <p>MINI STRIPPER CRIMPER 924-5001 7-8MM</p> |
|  <p>MINI STRIPPER CRIMPER 924-5002 8.5-9.5MM</p> |  <p>MINI STRIPPER CRIMPER SET 924-5003 7-8MM & 8.5-9.5MM</p> |  <p>O2 BUNG REPAIR KIT 88-833</p> |  <p>O2 BUNG REPAIR KIT 88-834</p> |  <p>O2 CHASER 88-837</p> |
|  <p>O2 SENSOR SOCKET 88-823</p> |  <p>O2 SENSOR SOCKET 88-836</p> |  <p>O2 WRENCH 88-829</p> |  <p>O2 WRENCH 88-835</p> |  <p>O2 WRENCH 2-1/8" OFFSET 88-830</p> |
|  <p>PLAIN INSTALL TOOL 86-3001 THREADS: 6-32</p> |  <p>PLAIN INSTALL TOOL 86-3002 THREADS: 8-32</p> |  <p>PLAIN INSTALL TOOL 86-3010 THREADS: 5/16-24</p> |  <p>PLAIN INSTALL TOOL 86-3015 THREADS: 1/2-20</p> |  <p>PLAIN INSTALL TOOL 86-3026 THREADS: M6 x 1</p> |
|  <p>TAP 86-2001 THREADS: 6-32</p> |  <p>TAP 86-2002 THREADS: 8-32</p> |  <p>TAP 86-2004 THREADS: 10-32</p> |  <p>TAP 86-2007 THREADS: 1/4-20</p> |  <p>TAP 86-2023 THREADS: M3 x 5</p> |

HIGH PERFORMANCE PRODUCTS • CARBURETION • CARBURETOR REPAIR KITS



TAP
86-2026
THREADS: M6 x 1



TAP
86-2027
THREADS: M8 x 1



TAP
86-2030
THREADS: M10 x 1



TAP
86-2031
THREADS: M10 x 1.5

GM SMALL BLOCK VALVE COVER GASKET - BLACK NITRILE COATED

Nitrile butadiene rubber binder for fluid resistance. Generally suitable for oil, gasoline and water services. For applications with intermittent operating temperatures up to 180oC (350oF).

SPECIFICATION

| | |
|---|------------|
| Density g/cm ³ (lbs./cu. ft.) min. | 0.61 (38) |
| Compressibility % at 6.9 MPa (1000 psi) | 32 - 46 |
| Minimum Recovery (%) | 25 |
| Minimum Tensile MPa (psi) | 5.52 (800) |

ASTM F-146 IRM 903

| | |
|------------------------------------|----|
| 22 hours at 21-24oC (70-75oF) | |
| Percent Change in Thickness (max.) | 15 |
| Percent Change in Weight (max.) | 70 |

ASTM F-146 Fuel B

| | |
|------------------------------------|----|
| 22 hours at 21-24oC (70-75oF) | |
| Percent Change in Thickness (max.) | 25 |
| Percent Change in Weight (max.) | 75 |

ASTM F-146 Distilled Water

| | |
|------------------------------------|----|
| 22 hours at 21-24oC (70-75oF) | |
| Percent Change in Thickness (max.) | 25 |
| Percent Change in Weight (max.) | 50 |

Binder Type

| | |
|---------------|-------------------|
| Rubber Binder | Nitrile Butadiene |
|---------------|-------------------|



GM SMALL BLOCK VALVE COVER GASKET
- BLACK NITRILE COATED
VC-1

MISCELLANEOUS

FUEL INJECTION • OXYGEN SENSORS • BUNGS & PLUGS • ENGINE MANAGEMENT



1/4" BALL STUD
22-111
 THREADS: 10-32, LENGTH: 1.260"



1/4" BALL STUD
22-121
 THREADS: 10-32, LENGTH: .750"



1/4" BALL STUD
22-20
 THREADS: 10-32, LENGTH: .833"



1/4" BALL STUD
22-23
 THREADS: 10-32, LENGTH: .828"



1/4" BALL STUD
22-24
 THREADS: 1/4-28, LENGTH: .928"



7/32" BALL STUD
22-25
 THREADS: 1/4-20, LENGTH: .937"



1/4" BALL STUD
22-70
 THREADS: 5/16-18, LENGTH: 1.020"



1/4" BALL STUD
22-86
 THREADS: 5/16-18, LENGTH: 1.135"



BALL STUD - THROTTLE PIN
22-69
 ROCHESTER



BALL STUD - THROTTLE PIN
22-72
 ROCHESTER



BALL STUD - THROTTLE PIN
22-73
 ROCHESTER



FUEL FITTING
90-157



FUEL INLET FITTING
90-75
 CARTER/ROCHESTER



FUEL INLET FITTING
90-91
 ROCHESTER 2 & 4 BARRELS



FUEL INLET FITTING W/1" HEX
90-75-1

WPA-101 EXPANSION PLUG KIT



| PART # | DESCRIPTION | QTY | PART # | DESCRIPTION | QTY |
|--------|--------------------------------------|-----|--------|------------------------------|-----|
| 0-111 | ALUMINUM MIXTURE SCREW PLUG | 25 | 85-48 | ALUMINUM EXPANSION PLUG 5/8 | 50 |
| 0-112 | ALUMINUM THROTTLE SENSOR PLUG | 25 | 85-49 | ALUMINUM EXPANTION PLUG 7/16 | 50 |
| 0-50 | ALUMINUM HIGH SPEED PASSAGE PLUG | 50 | 85-50 | ALUMINUM EXPANSION PLUG 3/8 | 50 |
| 0-90-1 | ALUMINUM BOWL VENT PLUG, CARTER T.Q. | 50 | 85-53 | ALUMINUM EXPANTION PLUG 5/16 | 50 |
| 80-221 | 10-24 X 3/8 PHILLIPS SELF-TAP SCREW | 50 | 85-58 | ALUMINUM EXPANSION PLUG 1/2 | 50 |
| 85-47 | ALUMINUM EXPANSION PLUG 9/16 | 50 | | | |

WPA-102 CLIP RETAINERS & PINS



| PART # | DESCRIPTION | QTY | PART # | DESCRIPTION | QTY |
|--------|-------------------------|-----|--------|-----------------|-----|
| 32-10 | COTTER PIN 3/64 X 1/2 | 50 | 62-48 | ROD RETAINER | 50 |
| 32-11 | COTTER PIN 3/64 X 3/8 | 50 | 62-55 | ROD RETAINER | 50 |
| 32-28 | 3/32 X 1/2 ROLL PIN | 50 | 62-56 | ROD RETAINER | 50 |
| 32-46 | COTTER PIN 3/64 X 1/4 | 50 | 62-57 | E-CLIP RETAINER | 50 |
| 32-55 | COTTER PIN 1/32 X 9/16 | 50 | 62-59 | RETAINER | 50 |
| 62-104 | RETAINER 50 | | 62-62 | RETAINER | 50 |
| 62-42 | E-CLIP RETAINER | 50 | 62-63 | E-CLIP RETAINER | 50 |
| 62-44 | ROD CLIP RETAINER | 50 | 62-64 | E-CLIP RETAINER | 50 |
| 62-45 | DIAPHRAGM LINK RETAINER | 50 | 62-90 | E-CLIP RETAINER | 50 |
| 62-46 | CHOKE ROD RETAINER | 50 | 62-96 | E-CLIP RETAINER | 50 |
| 62-47 | E-CLIP RETAINER | 50 | | | |

WPA-103 FILTER AND BALL KIT



| PART # | DESCRIPTION | QTY | PART # | DESCRIPTION | QTY |
|--------|-------------------------------|-----|--------|--------------------------------|-----|
| 30-54 | FUEL FILTER SHORT (W/O CHECK) | 2 | 90-12 | CHECK BALL 5/32 CARBON STEEL | 50 |
| 30-55 | FUEL FILTER LONG (W/O CHECK) | 4 | 90-13 | CHECK BALL 3/16 CARBON STEEL | 50 |
| 30-57 | FILTER SCREEN | 6 | 90-146 | CHECK BALL 9/64 CARBON STEEL | 50 |
| 30-58 | FUEL FILTER ASSEMBLY FORD, VV | 6 | 90-19 | CHECK BALL 3/16 ALUMINUM | 50 |
| 30-66 | FUEL FILTER SCREEN | 6 | 90-20 | CHECK BALL 5/32 ALUM. GRD 2000 | 50 |
| 30-70 | FUEL INLET STRAINER | 2 | 90-21 | CHECK BALL 1/8 CARBON STEEL | 50 |
| 30-74 | FUEL FILTER | 2 | 90-32 | CHECK BALL 1/8 ALUMINUM | 50 |

WPA-104 CHECK VENT VALVE & MISCELLANEOUS KIT



| PART # | DESCRIPTION | QTY | PART # | DESCRIPTION | QTY |
|--------|------------------------------------|-----|--------|------------------------------|-----|
| 1014F | CHOKE COVER POP-RIVET | 50 | G600-1 | RUBBER VACUUM TUBE CAP (1/4) | 50 |
| 80-221 | 10-24 X 3/8 PHILLIP SELF-TAP SCREW | 50 | G603 | VENT VALVE | 25 |
| 916F | CHOKE COVER POP-RIVET | 50 | G652 | BODY FLANGE GASKET | 25 |
| G1138 | RUBBER VENT VALVE | 50 | G679 | RUBBER VENT VALVE | 10 |
| G1245 | RUBBER VENT VALVE | 50 | G797 | RUBBER VENT VALVE | 10 |
| G582 | UMBRELLA CHECK VALVE | 25 | | | |



HIGH PERFORMANCE PRODUCTS • CARBURETION • CARBURETOR REPAIR KITS
FUEL INJECTION • OXYGEN SENSORS • BUNGS & PLUGS • ENGINE MANAGEMENT

Supplying quality products since 1946



As an industry leader, Walker Products Inc. has evolved into a premier supplier of fuel delivery components, emission control products, engine sensors, ignition wire sets, and coil-on-plug boots. Being in the forefront of new technologies, state-of-the-art engineering, automated manufacturing processes, along with great customer service has made Walker Products Inc. the right choice as your supplier of automotive products. All of our products live up to OE specifications and your demanding standards. We are proud of our history and commitment to the automotive aftermarket.

Our Standards... OE Fit, Form & Function
MORE Coverage, FEWER SKUs, HIGHER Profits

Servicing the industry for over 70 years to reduce your inventory and increase coverage and profits.



**HIGH PERFORMANCE PRODUCTS • CARBURETION • CARBURETOR REPAIR KITS
FUEL INJECTION • OXYGEN SENSORS • BUNGS & PLUGS • ENGINE MANAGEMENT**



WALKER PRODUCTS, INC.

525 WEST CONGRESS STREET • PACIFIC, MO 63069 • www.walkerproducts.com

U.S. Corporate Office: 636-257-2400 • Fax: 636-257-6211

Customer Service: 636-257-1700 • Technical Support: 844-252-0114

U.K. Sales Office and Distribution Center: +44-121-459-8006 • saleseurope@walkerproducts.com

Oficinas para Mexico: +52-72-2402-2167

Soporte tecnico y servicio al cliente en Mexico: +52-72-2207-8957